



Transport
Canada

Transports
Canada

TP10038E



(03/2003)

SMALL FISHING VESSEL

SAFETY MANUAL

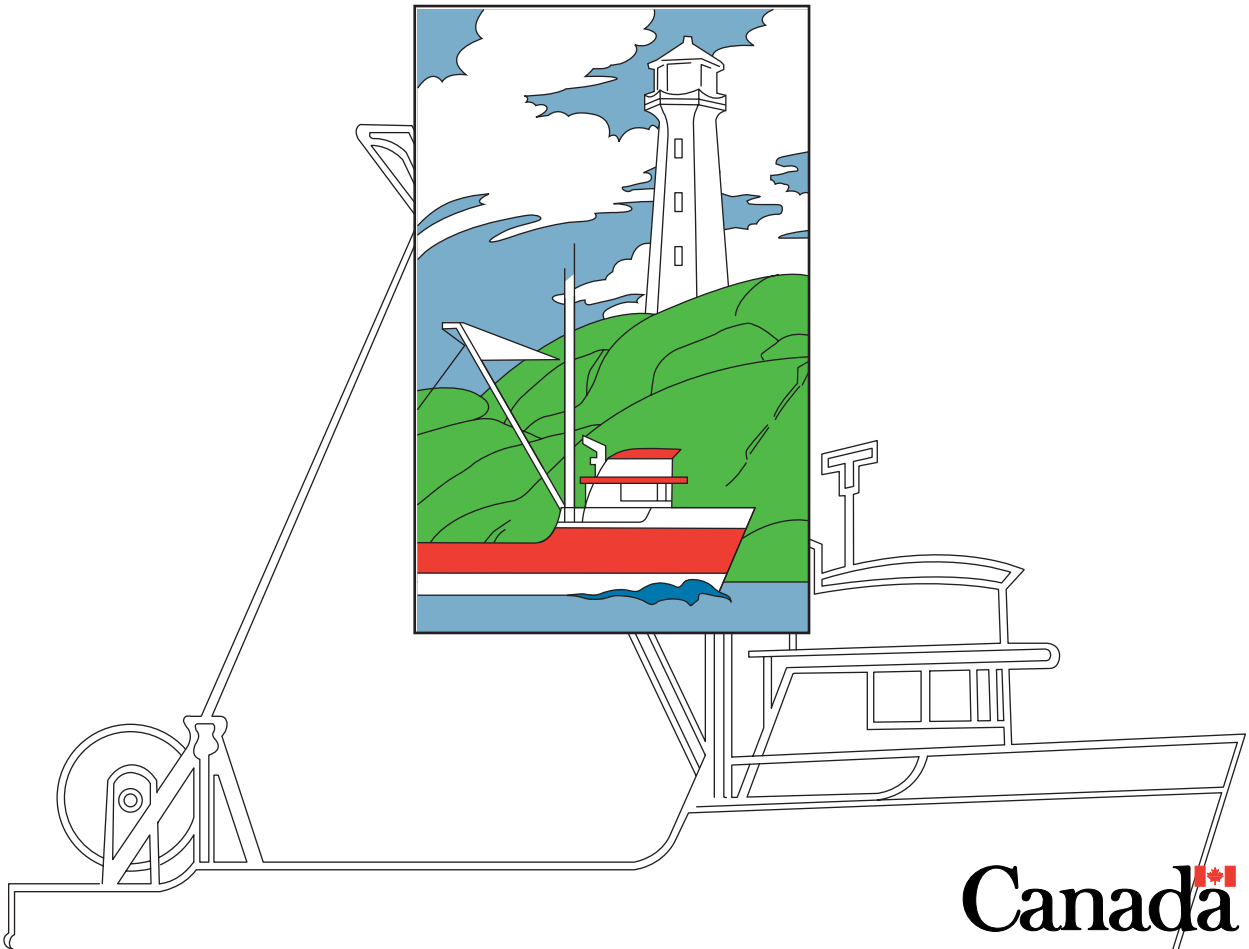

Canada 

Vessel Information

Telephone number of nearest RCC or MRSC	
Vessel Name	
Colour of Hull	Vessel Registration #
Colour of Deck	Vessel License #
Colour of Cabin	Fishing #
# of flares	# of lifejackets
# of immersion suits/work suits	# make and size of liferaft
# and description of lifeboats	
Name of Master	
Address	
Phone Number	Home Port
Length of Vessel	Type of Vessel
Radio Equipment Frequencies Fitted:	
VHF	
GRS (CB)	
EPIRB	
MF	
Lifeboat	
MF/HF	
Other	

SMALL FISHING VESSEL

TP10038E



(03/2003)

SAFETY MANUAL

© Her Majesty the Queen in Right of Canada, as represented by the Minister of Transport 2003.

Permission is granted by the Department of Transport, Canada, to copy and/or reproduce the contents of this publication in whole or in part provided that full acknowledgment is given to the Department of Transport, Canada, and that the material be accurately reproduced. While use of this material has been authorized, the Department of Transport, Canada, shall not be responsible for the manner in which the information is presented, nor for any interpretations thereof.

The information in this copy of this publication may not be updated to reflect amendments made to original content. For up-to-date information contact the Department of Transport, Canada.

ISBN 0-662-33826-X

Catalogue N° T31-67/2003E

Related Publications:

Small Fishing Vessel Inspection Regulations
TP 127 – Electrical Standard
TP 782 – Guide to Inspection Regulations for Small Fishing Vessel
TP 3231 – Ship Safety Bulletins
TP 4957 – Marine Emergency Duties Training Programme
TP 5021 – Personal Safety on Ships
TP 13822 – Survival in Cold Waters

Previous Editions:

1989 Catalogue N° T31-67/1990E ISBN 0-662-17531-X © Minister of Supply and Services Canada 1989
1993 Catalogue N° T31-67/1993E ISBN 0-662-17531-X © Minister of Supply and Services Canada 1989

Printed in Canada

Please direct comments and questions about this publication to:

Transport Canada Marine Safety
Construction and Equipment Standards
Tower 'C', Place de Ville
330 Sparks Street,
Ottawa, Ont.
K1A 0N8

or shipshape@tc.gc.ca

Foreword

For the crew of a fishing vessel, safety must be given top priority. Attention to safety will save lives, protect the vessel from damage, prevent serious injuries, and protect the environment.

The Masters or Operators of all fishing vessels have a duty to continuously train their crews for safety. This handbook provides information on safety on small fishing vessels (under 24 metres), and is intended primarily for vessels where the Master or Operator does not hold a certificate of competency or has limited vocational training.

This safety manual is not a substitute for compliance with the regulations applicable to every vessel. Please consult the regulations for the complete requirements.

Director
Construction and Equipment Standards
Ship Design & Fishing Vessels
Transport Canada, Marine Safety
Tower “C” Place de Ville
330 Sparks Street, 11th Floor
Ottawa On K1A 0N8
shipshape@tc.gc.ca

Contents

DEFINITIONS	V
NAVIGATING SAFELY	1
Rules of the Road.....	2
Lights and Signals.....	8
Buoys and Markers	13
Navigation Equipment	20
Sailing Plans	22
STABILITY	25
Centre of Gravity	26
The Free Surface Effect	27
Loose Water or Fish on Deck	28
Loading and Unloading	29
Icing Conditions.....	29
Freeboard	30
SAFETY ON THE JOB.....	31
Housekeeping.....	32
Working Safely	34
Working Aloft	38
Directing Winch or Crane Operations	39
Fire Prevention.....	40
Refuelling Precautions.....	43
EQUIPMENT AND INSTALLATIONS.....	45
Ropes and Tackle	49
Other Equipment	54

LIFE SAVING EQUIPMENT.....	59
First Aid Kits.....	61
Fire Extinguishers	62
Life Jackets	63
Immersion Suits	64
Life Rafts	65
Boats	67
Distress Flares.....	68
EPIRB	70
WEATHER INFORMATION	71
Weather Warnings	73
Severe Sea States	75
Thunderstorms	76
Fog and Snow	77
Icing	78
Metric Conversion Tables	79
Beaufort Scale	80
EMERGENCIES	81
Firefighting Tactics	82
Recovering Someone Who Falls Overboard.....	84
Hypothermia	88
Radio Distress Calls.....	91
Search and Rescue Signals.....	92
DISTRESS SIGNALS	94

Definitions

A ***power-driven vessel*** is any vessel propelled by machinery.

A ***sailing vessel*** is any vessel under sail, provided that propelling machinery, if fitted, is not being used.

A ***fishing vessel*** is any vessel used for catching fish, whales, seals, walrus or other living resources of the sea, including any vessel used to transfer the catch of another vessel to shore.

A ***vessel engaged in fishing*** is any vessel fishing with nets, lines, trawls or other fishing apparatus which restrict manoeuvrability, but does not include a vessel fishing with trolling lines or other fishing apparatus which do not restrict manoeuvrability.

A ***restricted vessel*** is any vessel unable to keep out of the way of another vessel because it is engaged in work restricting its ability to manoeuvre as required by the Collision Regulations or any vessel constrained by a channel.

A ***vessel not under command*** is any vessel, which through unusual circumstances is unable to manoeuvre as required by the Collision Regulations, and so is unable to keep out of the way of another vessel.

NAVIGATING SAFELY



Rules of the Road

The *Rules of the Road* apply when one vessel approaches another, and determine what each vessel must do.

The best defence against collision is keeping a proper lookout at all times by sight and hearing.

Meeting Another Vessel Head-On

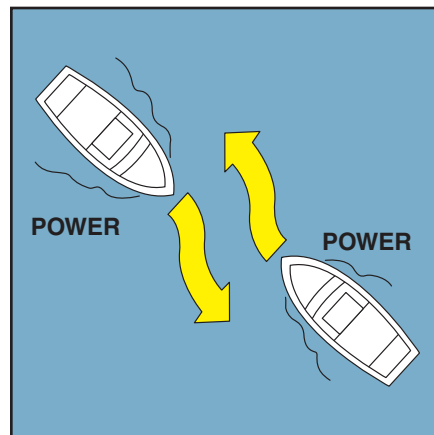

If two power-driven vessels meet head-on, both must give way by altering their course to starboard.

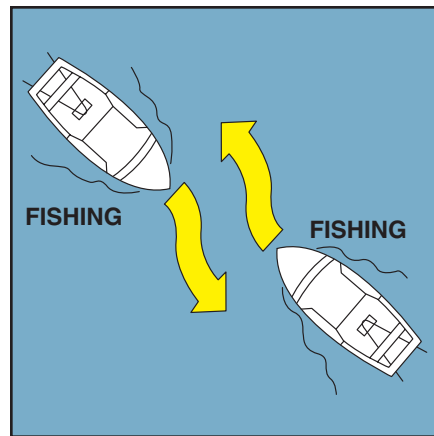

If two fishing vessels meet head-on, both must give way by altering their course to starboard.

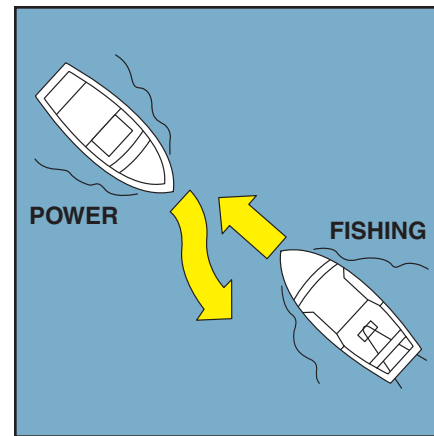

If a power-driven vessel meets a vessel engaged in fishing head-on, the power-driven vessel must give way. The fishing vessel should maintain its course and speed.

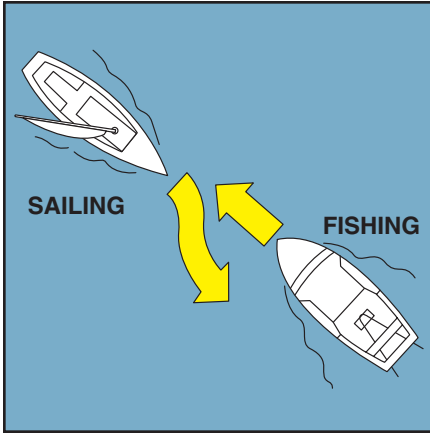

If a sailing vessel meets a vessel engaged in fishing head-on, the sailing vessel must give way. The fishing vessel should maintain its course and speed.

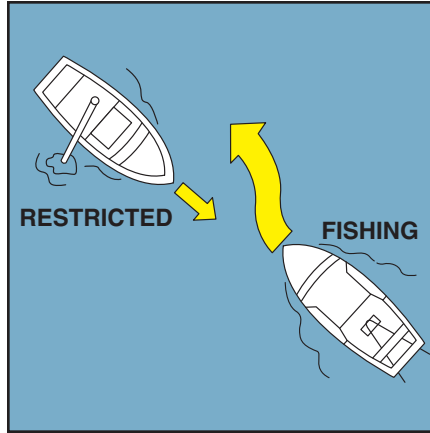

If a vessel engaged in fishing meets a restricted vessel head-on, the fishing vessel must give way.

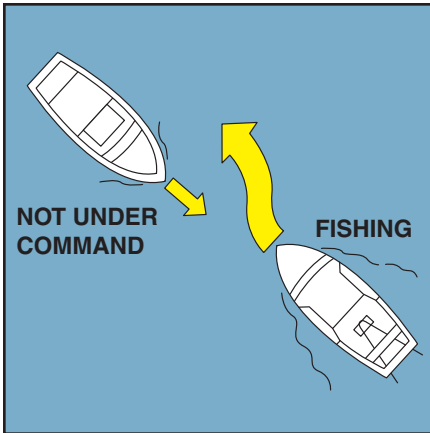

If a vessel engaged in fishing meets a vessel not under command head-on, the fishing vessel must give way.

Crossing the Path of Another Vessel

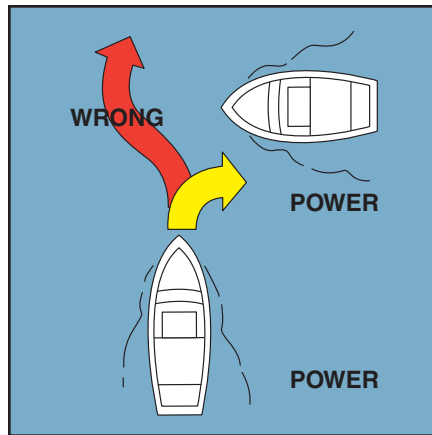

A power-driven vessel approaching another power-driven vessel on its own starboard side must give way and avoid crossing ahead of the other vessel.

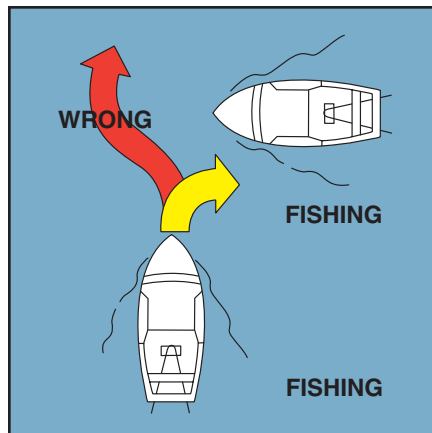

A fishing vessel approaching another fishing vessel on its own starboard side must give way.

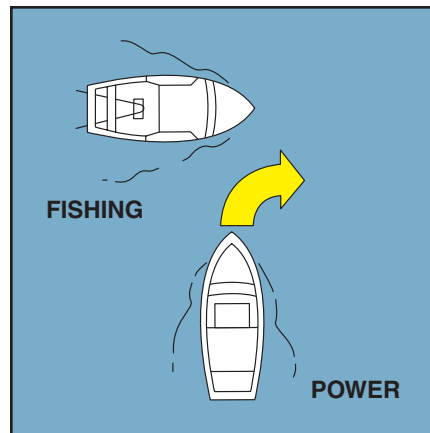

A power-driven vessel approaching a vessel engaged in fishing on *either* of its sides must give way.

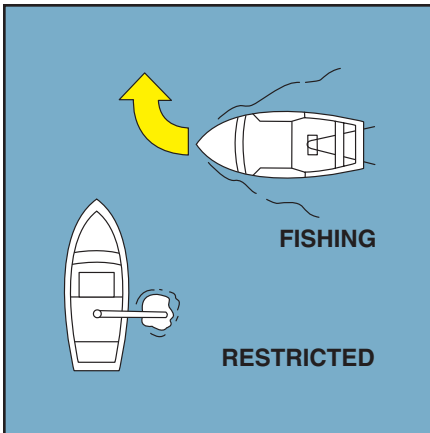

A vessel engaged in fishing approaching a restricted vessel on *either* of its sides must give way.

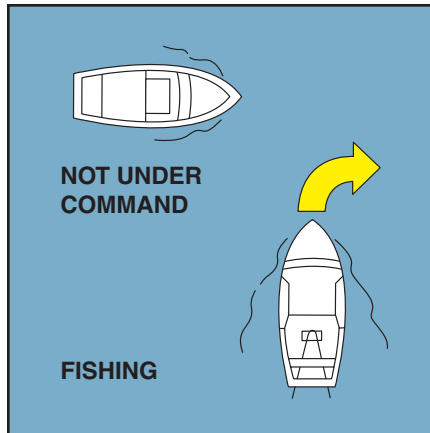

A vessel engaged in fishing approaching a vessel not under command on *either* of its sides must give way.

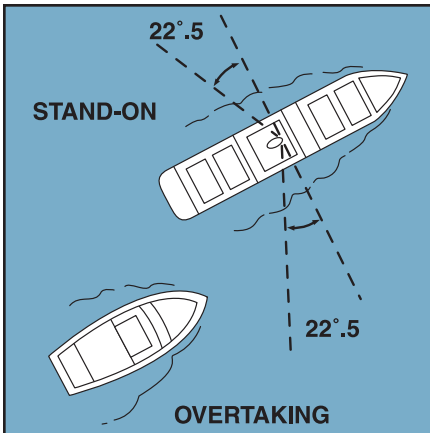

A vessel is overtaking another when it is coming up with another vessel, from a direction more than 22.5 degrees abaft its beam. The overtaking vessel must keep clear of the stand-on vessel. The stand-on vessel must maintain its course and speed until the overtaking vessel is finally past and clear.

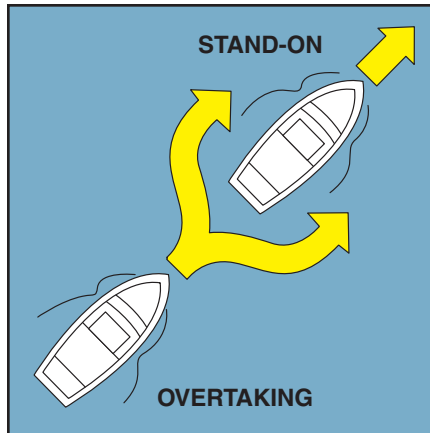

Any vessel overtaking another must keep clear of the stand-on vessel.

Overtaking another vessel

Restricted Visibility

If you cannot see other vessels because of fog or bad weather, reduce speed, sound your fog signal, proceed with extreme caution and be prepared to stop.

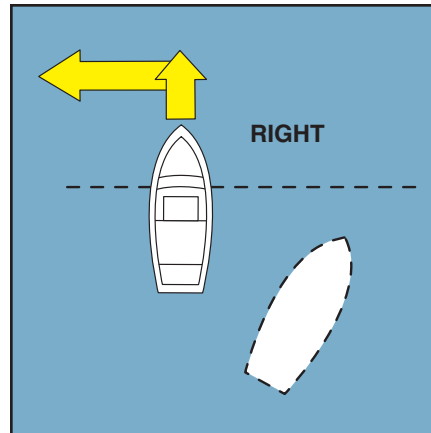
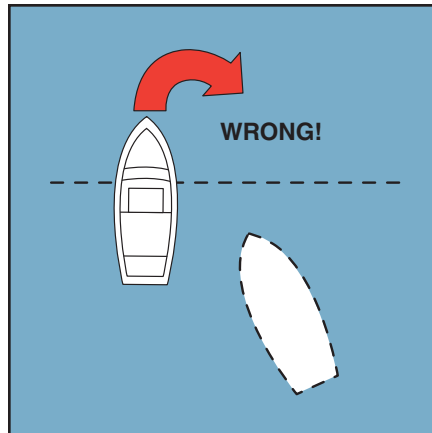

If you detect a vessel abeam or behind the beam by radar alone avoid turning *toward* the vessel if at all possible.

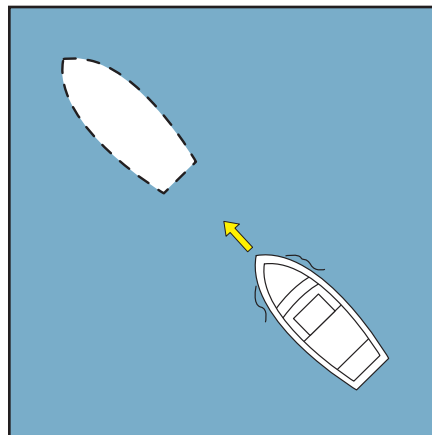

If you hear the foghorn of another vessel apparently forward of your beam, reduce your speed to the minimum needed to keep on course, be prepared to stop and navigate with extreme caution.

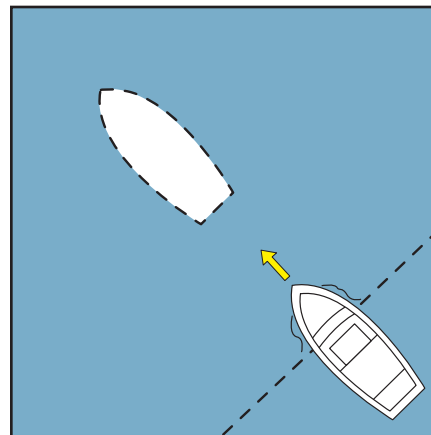

If you detect a vessel forward of the beam *by radar alone*, avoid altering course to port, except in cases of overtaking another vessel.

Narrow Channels and Traffic Lanes



A vessel engaged in fishing must not block the passage of any vessel navigating in narrow channels.

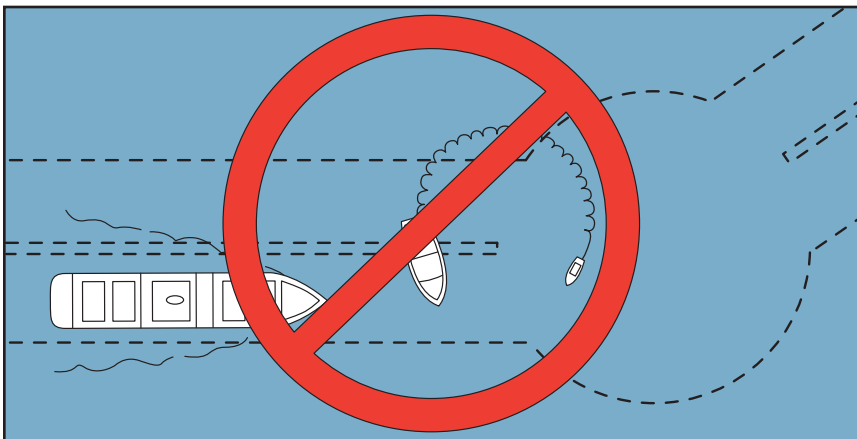

A vessel engaged in fishing must not block the passage of any vessel navigating in designated traffic lanes.

Lights and Signals

Navigation lights and signals tell other vessels not only where you are, but what you are doing. Using these lights and signals properly is an important part of safe navigation.

The following diagrams show some of the navigation lights and shapes exhibited by fishing vessels less than 20 metres in length.

(Note : a vessel that is "underway" is one that is not anchored, made fast to shore, or aground.)

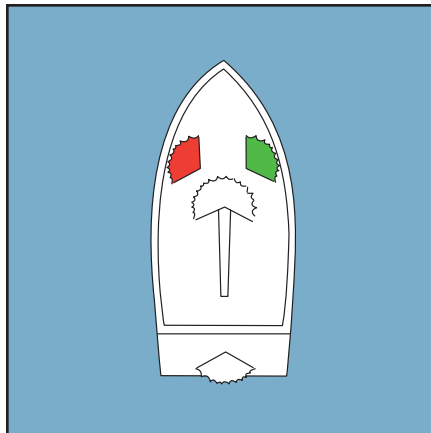

A *power-driven* fishing vessel not engaged in fishing when underway. (Fishing vessels of less than 12 metres in length may, in lieu of these lights, exhibit an all-round white light and sidelights).

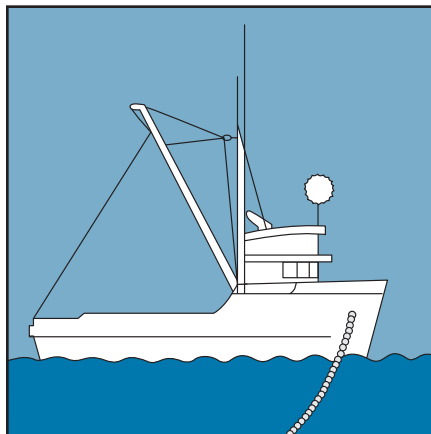

A vessel at anchor.

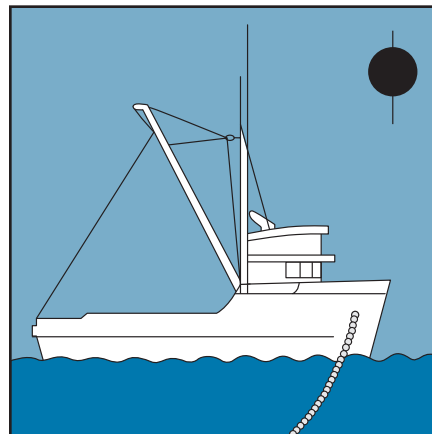

DAY SIGNAL

STARBOARD VIEW

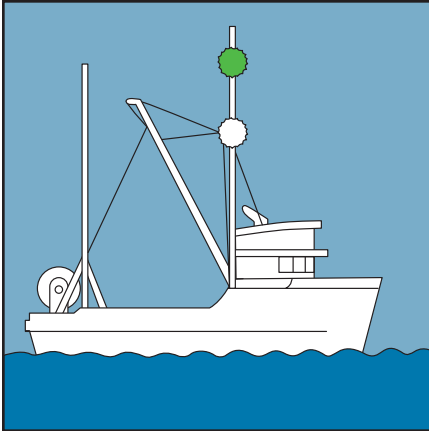

BOW VIEW

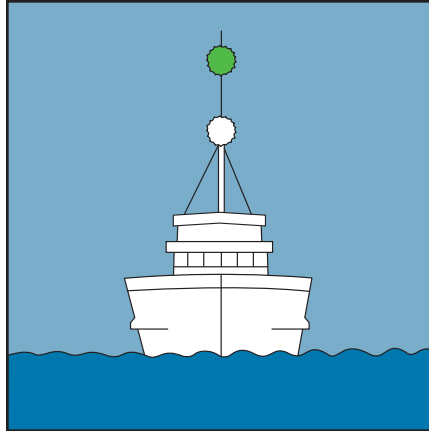

STERN VIEW

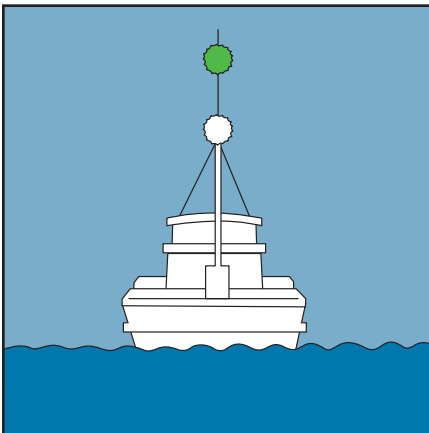

DAY SIGNAL

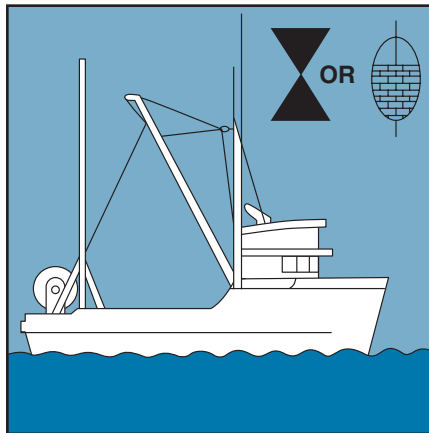

A vessel engaged in trawling, underway, but not making way through water.

STARBOARD VIEW

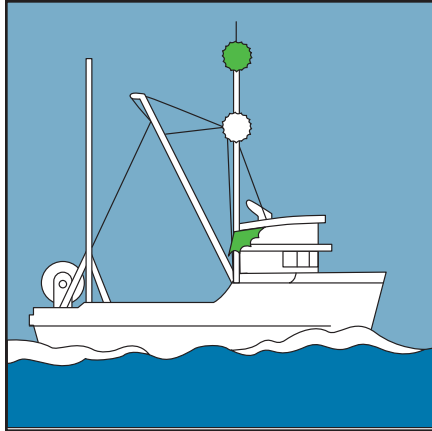

BOW VIEW

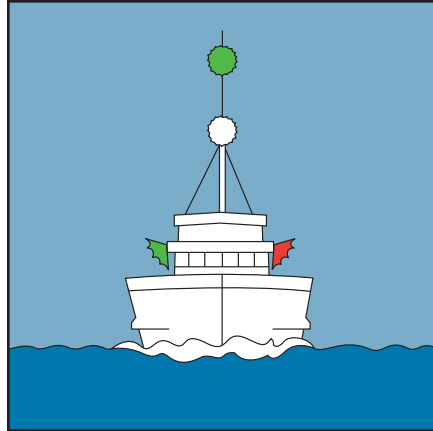

STERN VIEW

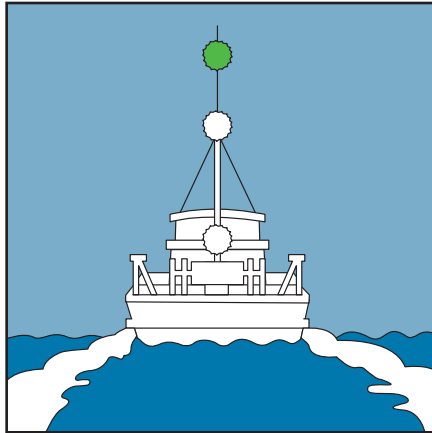

DAY SIGNAL

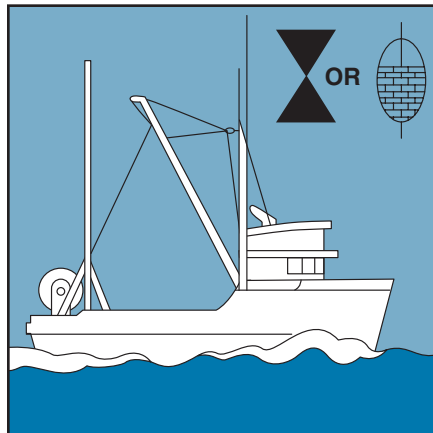

A vessel engaged in trawling underway, and making way through water.

STARBOARD VIEW

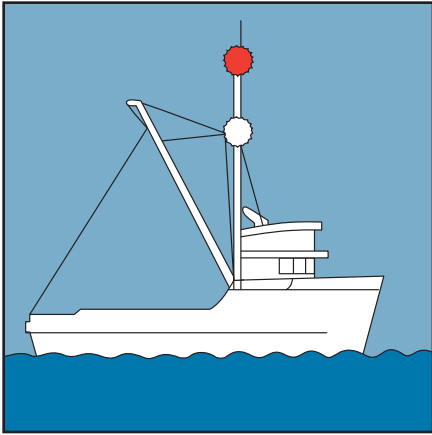

BOW VIEW

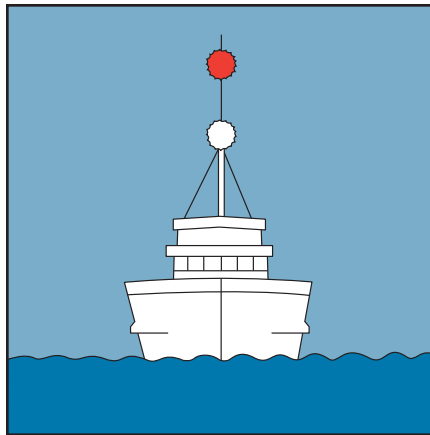

STERN VIEW

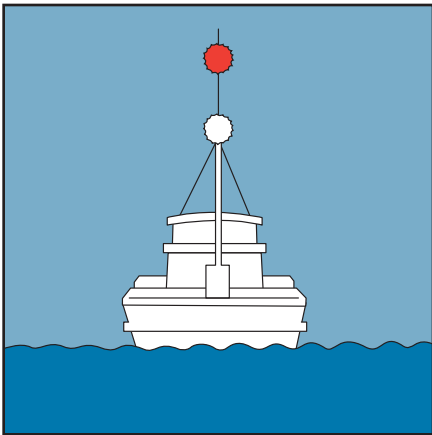

DAY SIGNAL

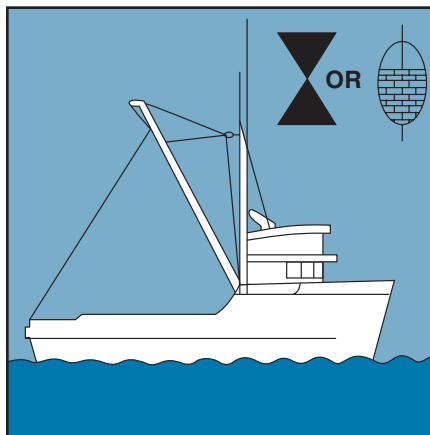

A vessel engaged in fishing other than trawling underway, but not making way through water, with gear extending no more than 150 metres horizontally.

A vessel engaged in fishing other than trawling underway and making way through water, with gear extending more than 150 metres horizontally.

STARBOARD VIEW

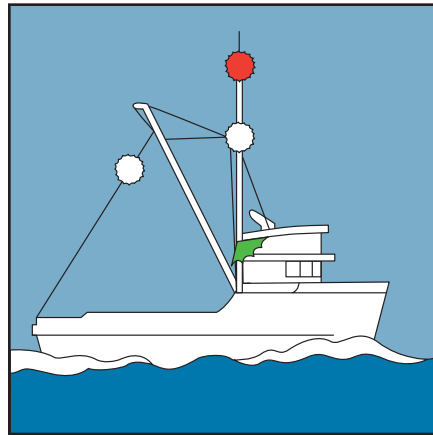

BOW VIEW

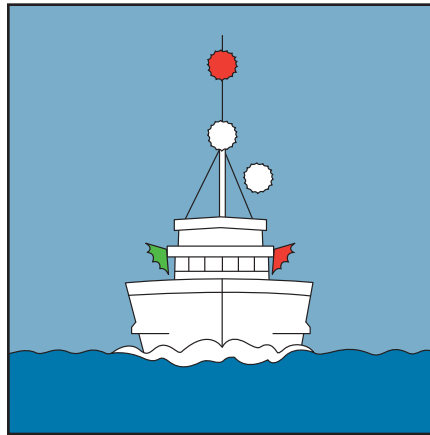

STERN VIEW

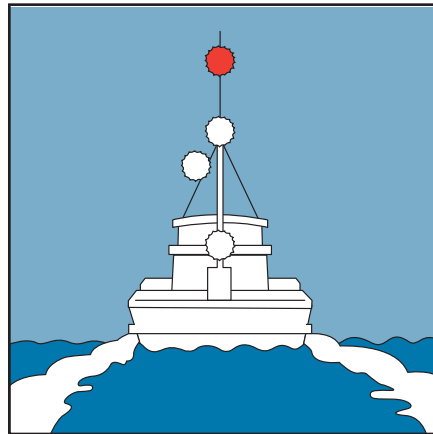

DAY SIGNAL

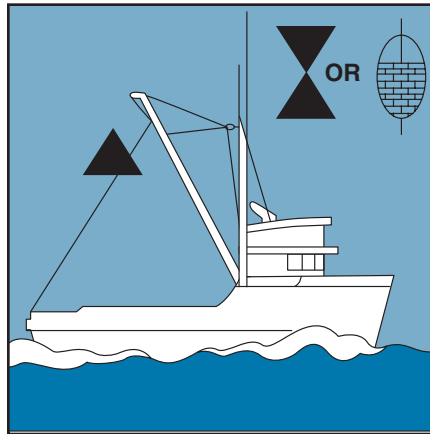

There are many other lights and visual signals, as well as sound signals, to be used in special conditions. For more information, check the most recent edition of the *Collision Regulations*, available from authorized bookstore agents or from:

**GOVERNMENT OF
CANADA PUBLICATIONS**
Communication Canada
Ottawa, ON K1A 0S9
1-800-635-7943
<http://publications.gc.ca/>

Buoys and Markers

Buoys and markers are invaluable guides to safe navigation. The system of buoys used in Canada is outlined below. Complete details of the system are available from all Coast Guard offices, chart distributors, or CHS chart distributors.

Upstream direction: is the direction taken by a vessel when proceeding from seaward, toward the headwaters of a river, into a harbour or with the flood tide.

Lateral Buoys

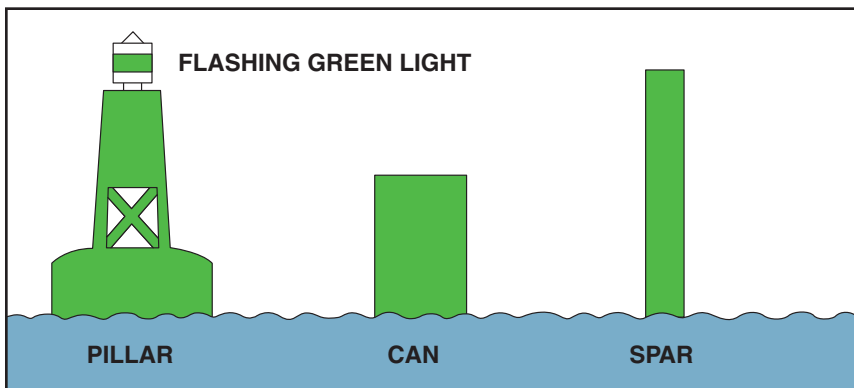

Keep all solid green buoys on your port (left) side when moving in the upstream direction.

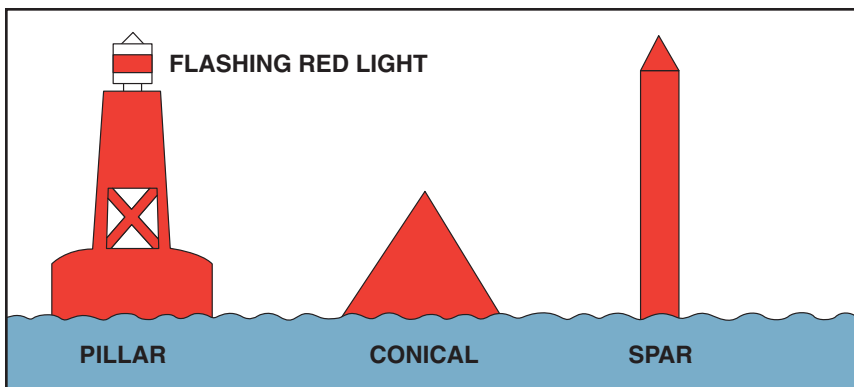

Keep all solid red buoys on your starboard (right) side when moving in an upstream direction.

Bifurcation Buoys

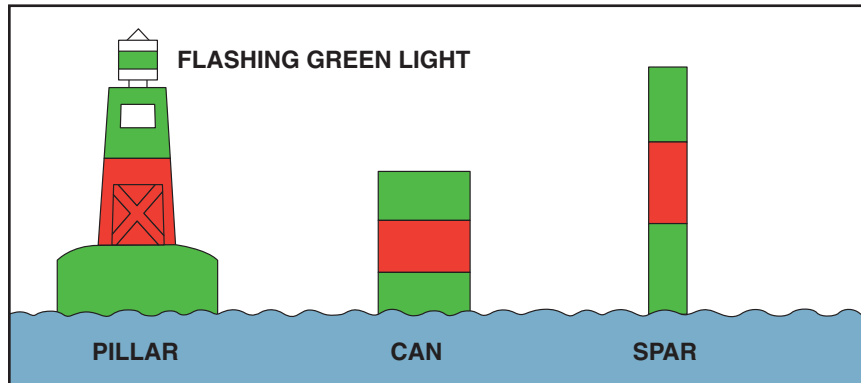

You may pass buoys with red and green bands on either side in the upstream direction. The main or *preferred* channel is shown by the colour of the top band. For example, you should keep the buoys pictured here on your port (left) side.

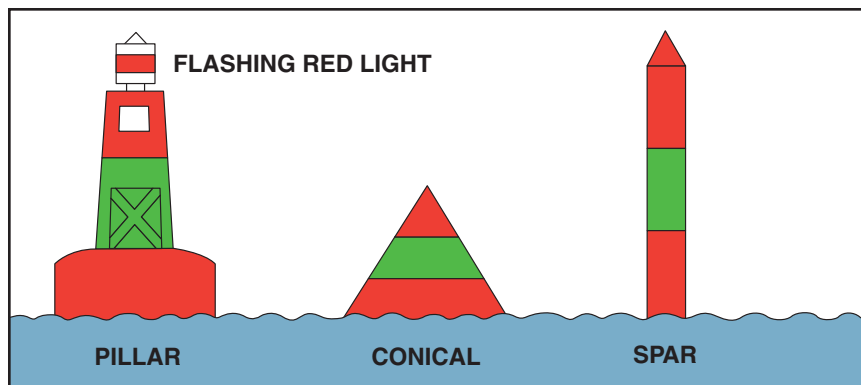

You may pass buoys with red and green bands on either side in the upstream direction. The main or *preferred* channel is shown by the colour of the top band. For example, you should keep the buoys pictured here on your starboard (right) side.

You may pass these buoys on either side, but when it is marking the middle of a channel it should be kept on your port (left) side.

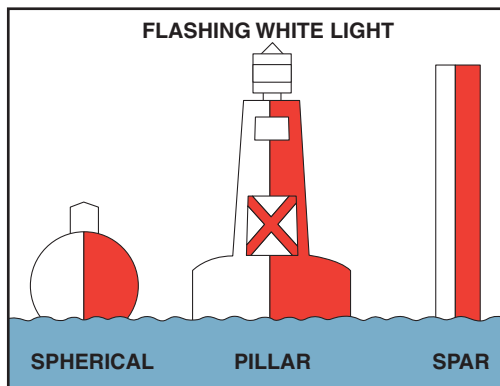

Fairway Buoys

Cardinal buoys, marked in yellow and black, show where the deepest or safest water is. The North, East, South and West cardinal buoys are distinguished by their colour pattern, and by their top marks.

Cardinal Buoys

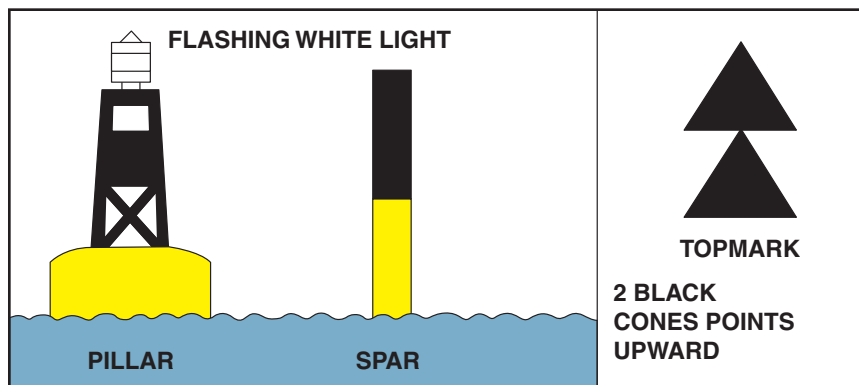

The North cardinal buoy is black on top and yellow on bottom. The safe water lies to the north of this buoy.

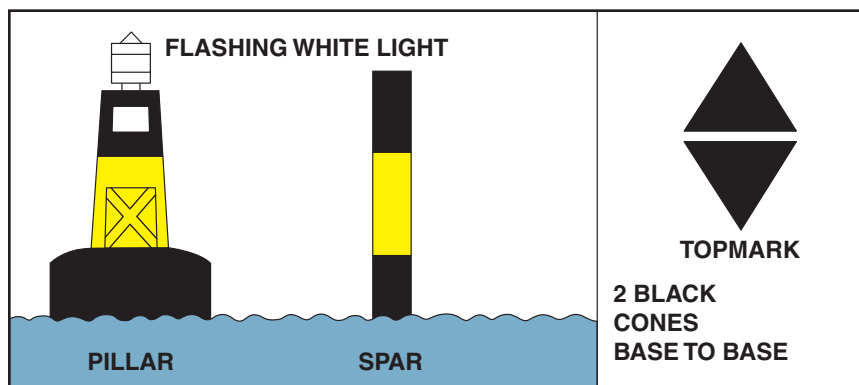

The East cardinal buoy is black with a yellow band. The safe water lies to the east of this buoy.

Cardinal Buoys (continued)

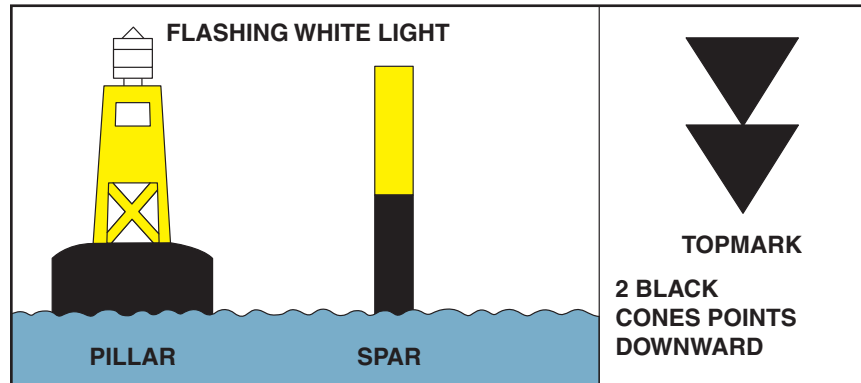

The South cardinal buoy is yellow on top and black on bottom. The safe water lies to the south of this buoy.

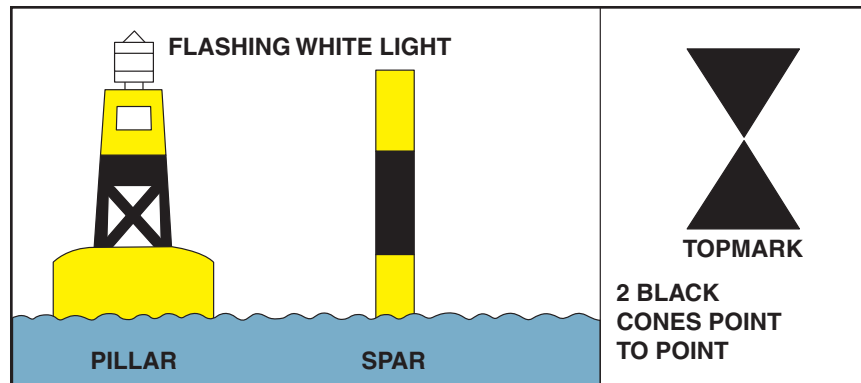

The West cardinal buoy is yellow with a black band. The safe water lies to the west of this buoy.

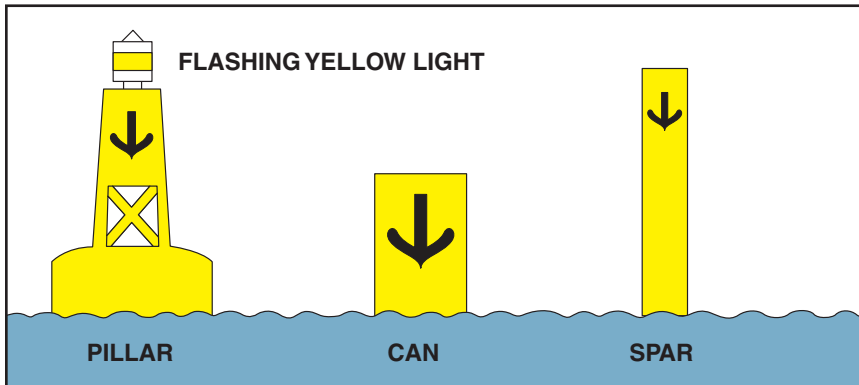

Special Purpose Buoyage

Anchorage Buoyage

Buoys with the anchor symbol mark the perimeter of designated anchorage areas. Before anchoring, consult your charts for water depths.

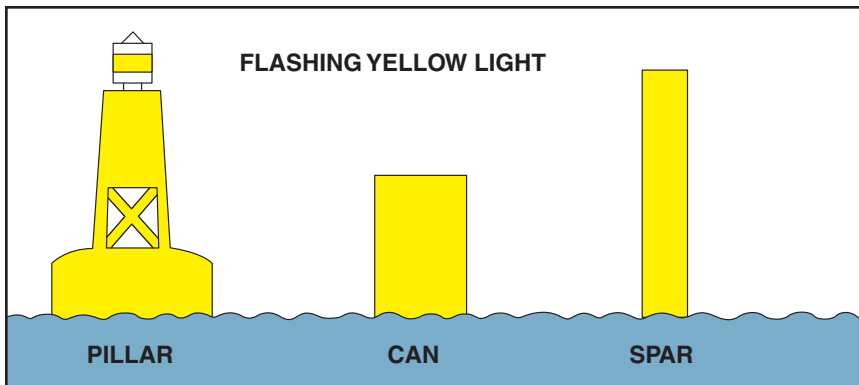

Cautionary Buoyage

Yellow buoys mark danger areas, such as military exercise areas, underwater structures, race courses, seaplane bases, or areas where there is no through or safe channel. Consult your charts for details on the danger.

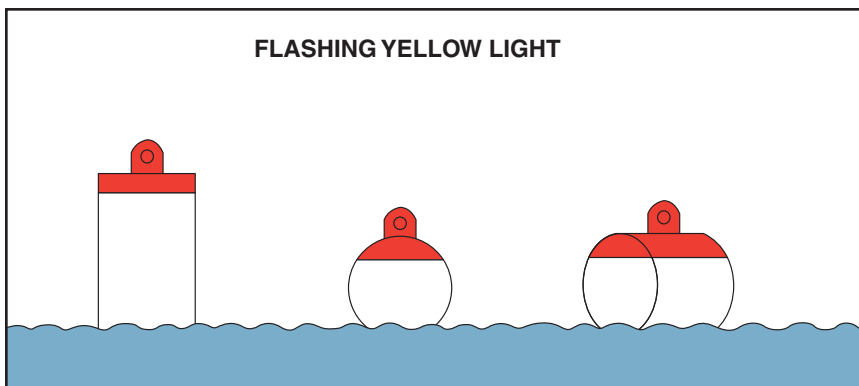

Mooring Buoyage

These buoys are used for mooring or securing vessels.

Special Purpose Buoys (continued)

Keep Out Buoys

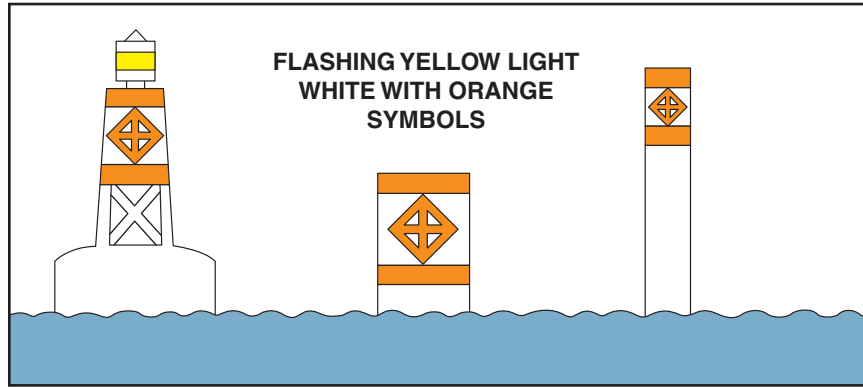

Buoys with this symbol mean *Keep Out*. They mark areas where boats are prohibited.

Control Buoys

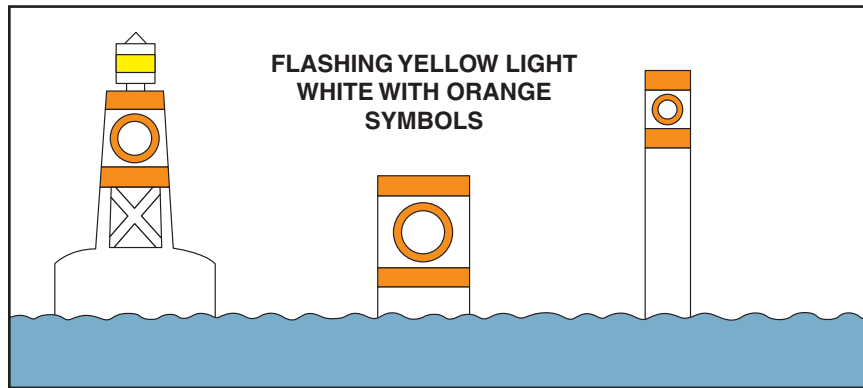

Buoys with this symbol indicate special rules, such as speed limits or wash restrictions. Obey the restriction shown inside the orange circle.

Information Buoys

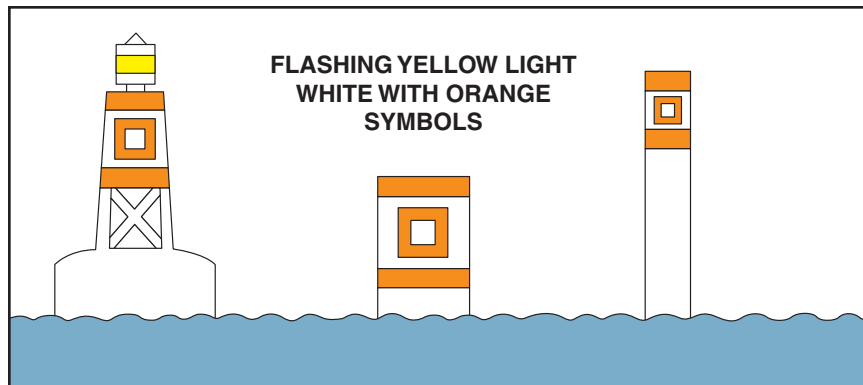

Buoys with this symbol display information such as locality, name, marina, campsite, etc.

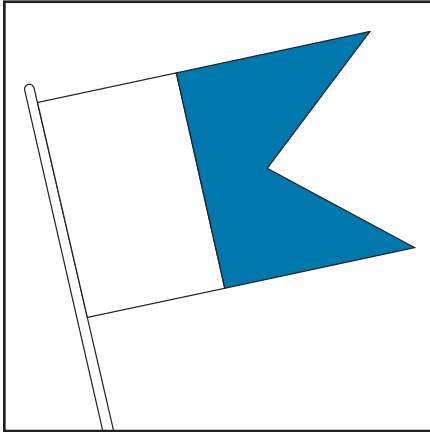

CODE FLAG A

Code Flag A

This flag indicates, "I have a diver down. Keep well clear at slow speed." *Collision Regulations* require that small vessels engaged in diving operations must display a rigid replica of this flag when restricted in their ability to manoeuvre.

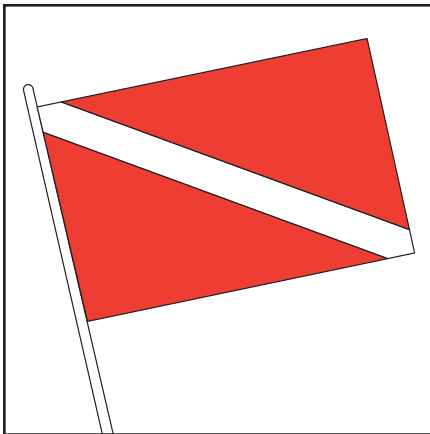

DIVING BUOY FLAG

Diving Buoy Flag

This flag is required by *Private Buoy Regulations* and indicates areas where scuba diving is in progress. Again, stay well clear and proceed with caution.

Navigation Equipment

Compass

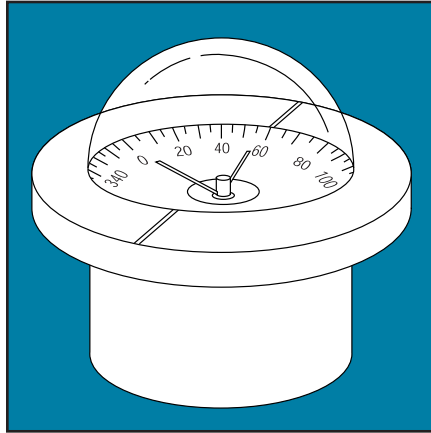

To maintain the accuracy of your magnetic compass:

- make sure it is located away from electrical interference
- ensure there are no bubbles if it has a wet card
- check for accuracy after any changes are made to the vessel.

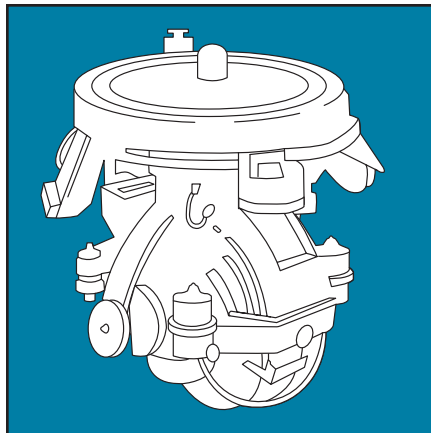

Gyro compasses should be switched on well before departure and checked often against the magnetic compass.

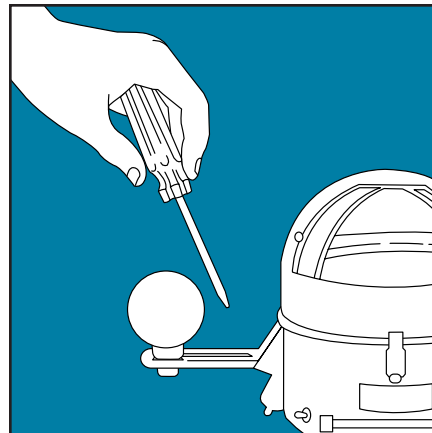

Any adjustments made must be done by a qualified compass adjuster.

Deviation Tables must be kept up to date, especially after changes in the vessel's electrical wiring or equipment, or any structural changes to the vessel.

Radar

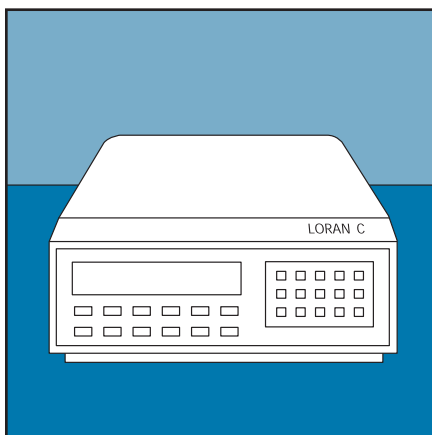

Fishermen are cautioned when using courses between waypoints with Loran C, the course and distance may be displayed as a Great Circle route and not a straight rhumbline. Fishermen should take this into account when laying their course. For more information see *Radio Aids to Marine Navigation*.

Fixing arrangements for radar reflectors should be provided so that they can be fitted either on a rigid mount or suspended in the rigging. For maximum performance, reflector should be mounted according to the orientation marked on the reflector.

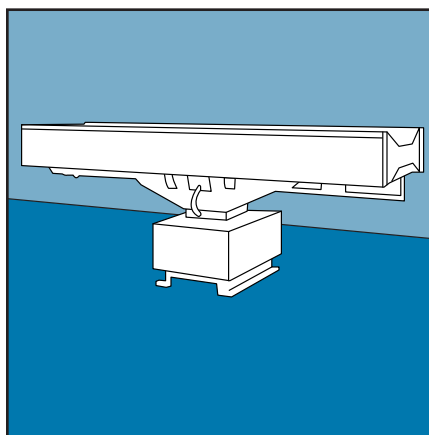

Make sure radar is operating before leaving port, and keep a radar watch when visibility is poor.

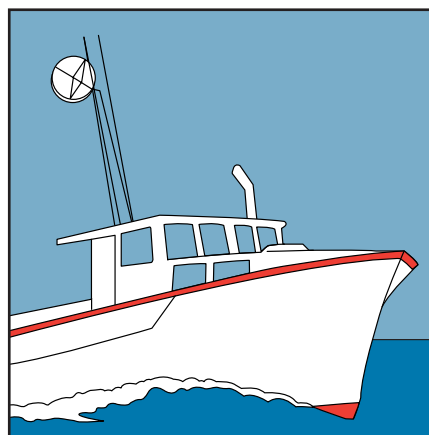

Radar reflectors are required for vessels less than 20 metres long, and for all non-metal vessels. Locate reflectors above all superstructure – at least 4 metres above the water if possible.

Sailing Plans

Before leaving home port, fishermen should prepare a sailing plan, and leave a copy of the plan with a responsible person on shore (a relative, wharfinger, union official, fish plant manager, local police, or fisheries officer). That person can then contact the Rescue Co-ordination Centre or Marine Rescue Sub-Centre if your vessel becomes overdue. The sailing plan will help guide search and rescue teams in the event of an emergency.

The sailing plan could be kept in a standard school notebook. A sample form for the plan is included. Shown on page 23 & 24.

After leaving port fishermen should contact the person holding the plan regularly, at least once a day. That person should be advised immediately if there are any changes to the scheduled voyage. The sailing plan must be cancelled upon completion of the voyage.

Sample Sailing Plan

Part 1 : Permanent details to be attached to the inside front cover of the notebook.

Telephone number of nearest RCC or MRSC	
Vessel Name	
Colour of Hull	Vessel Registration #
Colour of Deck	Vessel License #
Colour of Cabin	Fishing #
# of flares	# of lifejackets
# of immersion suits/work suits	# make and size of liferaft
# and description of lifeboats	
Name of Master	
Address	
Phone Number	Home Port
Length of Vessel	Type of Vessel
Radio Equipment Frequencies Fitted:	
VHF	
GRS (CB)	
EPIRB	
MF	
Lifeboat	
MF/HF	
Other	

Part 2 : Details of each voyage, using a separate page for each trip.

<u>Departure date and time</u>
<u>Vessel endurance in hours and days</u>
<u>Intended fishing areas</u>
<u>Proposed Route</u>
<u>Estimated date and time of return</u>
<u>Number of persons on board</u>
<u>Times of radio calls to person holding the plan</u>
<u>Probable port of refuge</u>
<u>If fishing with another vessel, name of other vessel</u>

STABILITY

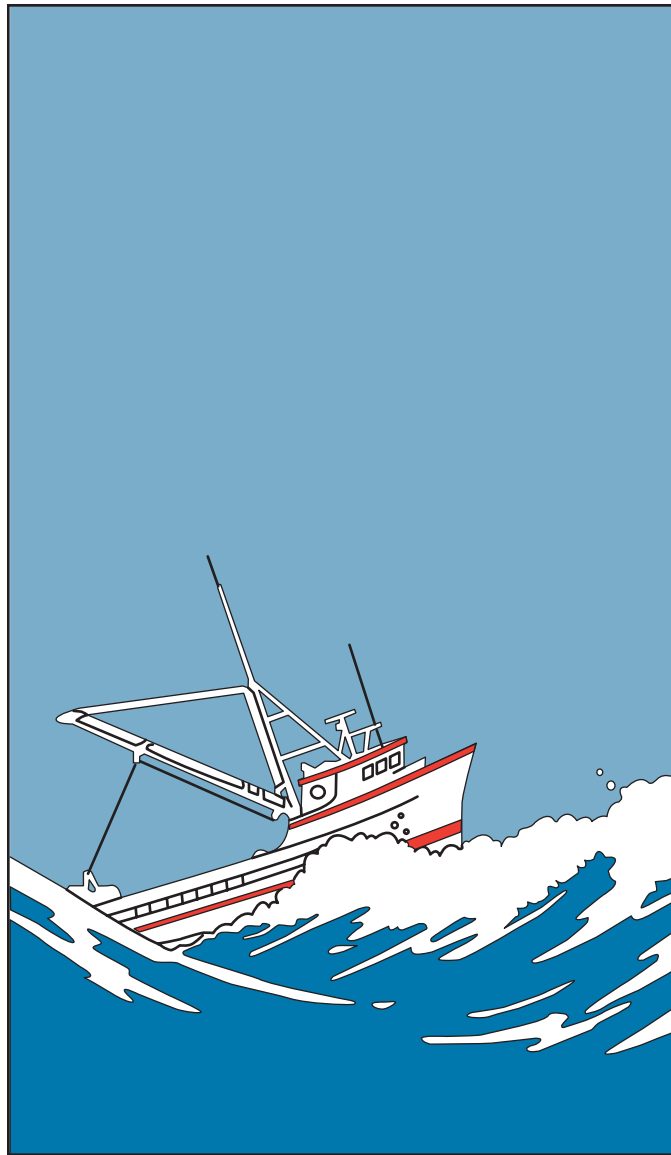

Stability

The *stability* of a vessel refers to its ability to stay upright in the water.

Many different things can affect the stability of a vessel and cause it to capsize. However, these things can be controlled. A well-designed vessel will not capsize even in the worst conditions – if it is operated properly.

Fishing vessel stability is a very complex subject. Some basic rules are outlined below. For more detailed information consult a standard stability text book.

Centre of Gravity

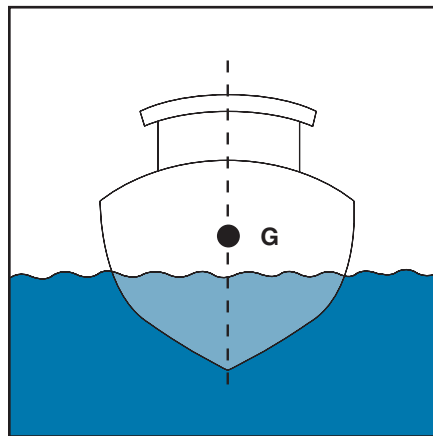

The centre of gravity (G) is the point at which the whole weight of the vessel can be said to act vertically downward. As a general rule, a *lower* centre of gravity means a *more stable* vessel.

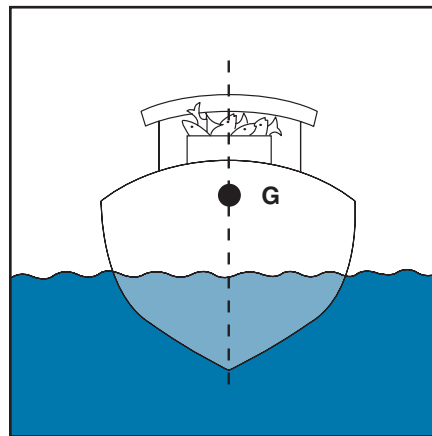

The centre of gravity changes, depending on how weight is distributed in the vessel. For example, a heavy load placed high on deck will produce a higher centre of gravity – and less stability – than a load stored below deck.

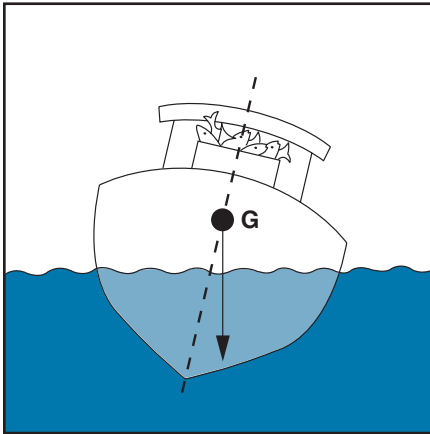

A vessel with a high centre of gravity is "top heavy." If it lists or heels to one side, the centre of gravity pushes down in the direction of the list. The danger of capsizing is much greater.

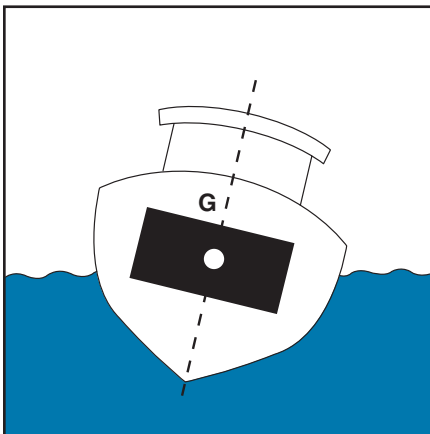

When a vessel with full tanks heels over, the contents of the tank do not shift. The tank's centre of gravity does not change, so it does not affect the vessel's stability.

The Free Surface Effect

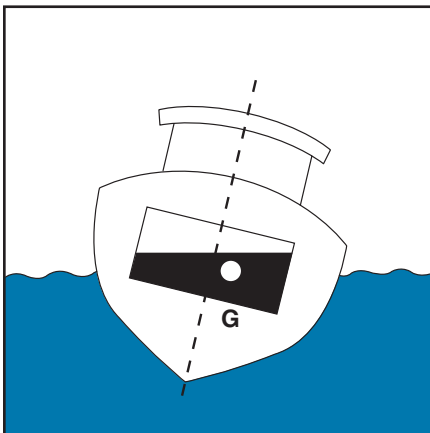

In a partly filled tank or fish hold, the contents will shift with the movement of the boat. This "free surface" effect increases the danger of capsizing.

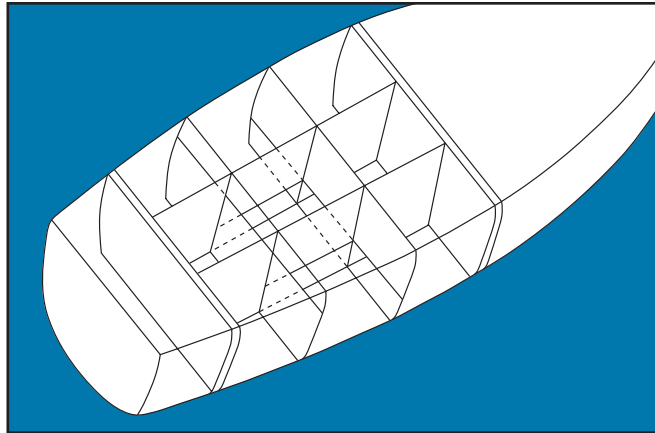
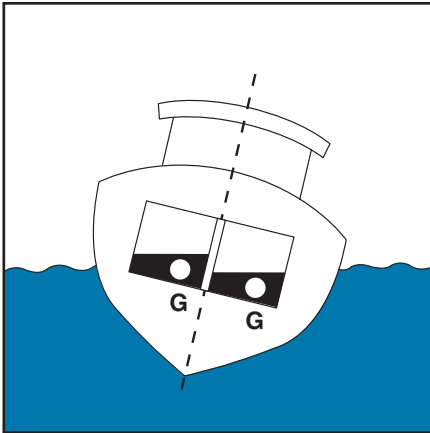

When a vessel with partially filled spaces heels over, the contents of the spaces will shift. The centre of gravity moves over to the side, making the vessel less stable. To avoid this free surface effect, try to have as few partially filled tanks and compartments as possible.

You cannot always avoid partly filled spaces. By dividing a tank into two equal parts with a baffle, the free surface effect is greatly reduced. Using boards to divide fish wells into compartments will also help.

Loose Water or Fish on Deck

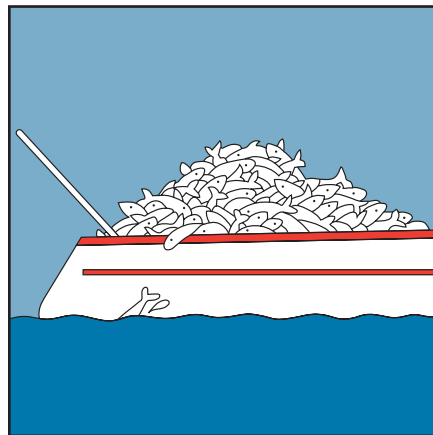

Fish left loose on deck have the same effect as water. Fish should be properly stowed in the hold as soon as possible to maintain stability.

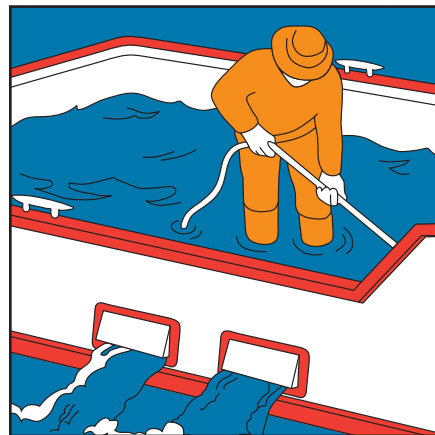

When water is shipped on deck and unable to escape, it creates a large free surface. It also adds weight high in the vessel. Freeing ports (scuppers) are vital for removing shipped water and maintaining stability.

Loading and Unloading

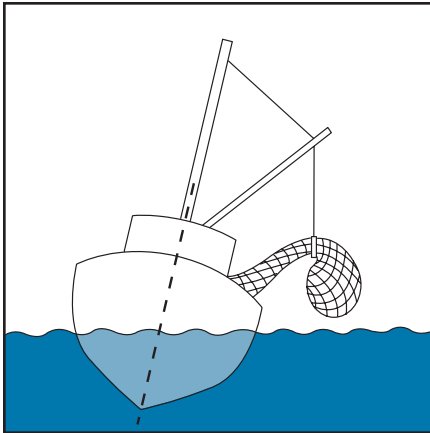

Loading and unloading operations have a dramatic effect on stability. For example, when a heavy load is lifted clear of the water it has the same effect on the vessel's centre of gravity as if the weight were actually at the head of the boom. The vessel will also heel. All such operations should proceed with extreme caution.

Icing Conditions

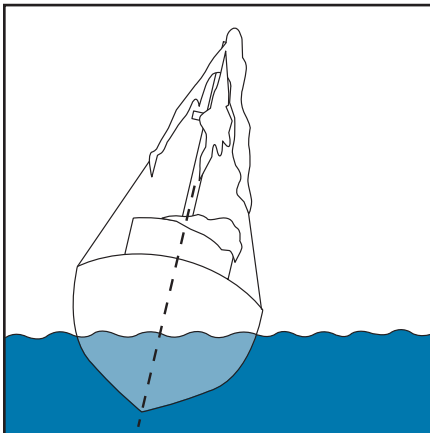

Heavy icing, especially when it accumulates, will seriously affect stability. In severe conditions it is very dangerous. If icing occurs, all fishing gear should be recovered and secured as low as possible on deck. Speed should be reduced, and the vessel turned downwind if possible. If crew are sent on deck, they should have safety lines attached. If possible, ice should be removed from upper structures.

Freeboard

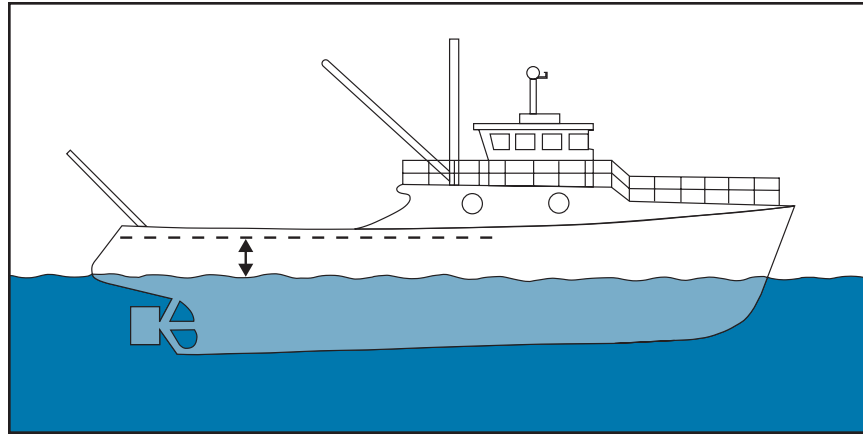

A proper freeboard is essential for stability. Freeboard is the distance between the water and the working deck of the vessel. If the deck edge goes under the water when the vessel heels, the danger of capsizing is great.

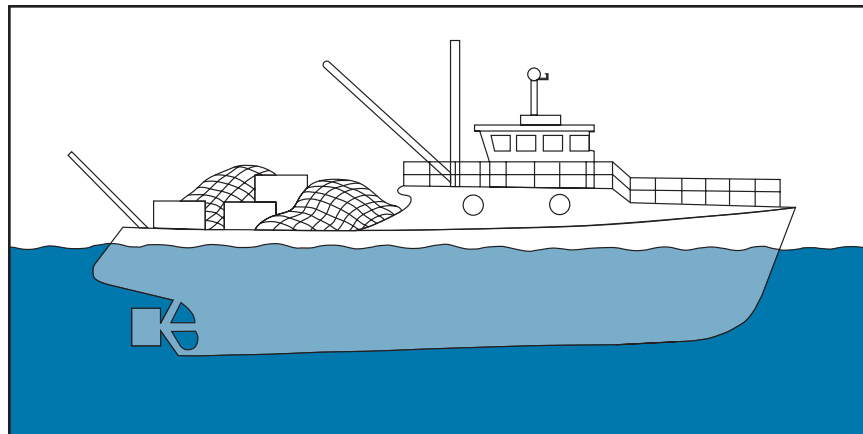

An overloaded vessel will have too low a freeboard. The deck will submerge with even a slight heel. ***Overloading is a major cause of fishing vessels capsizing.***

SAFETY ON THE JOB

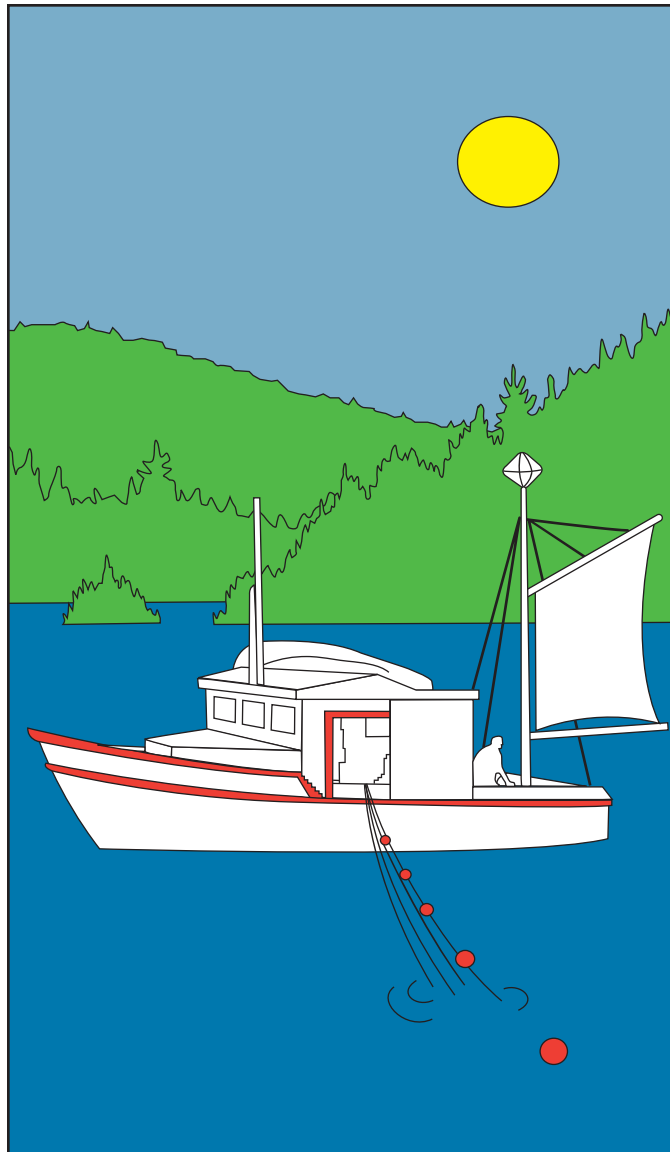

Safety on the Job

A fishing vessel can be a dangerous working environment. But the risk of accidents will be greatly reduced if proper precautions are taken. This section outlines some basic guidelines for avoiding accidents on board.

Housekeeping



An untidy deck is sure to cause accidents. Keep decks clear, and stow all ropes in coils.

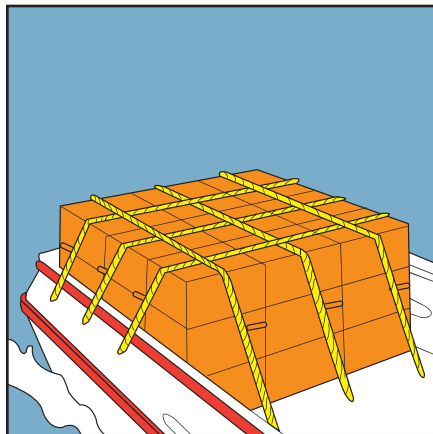

Deck gear should always be tied down so it won't come loose in the worst possible conditions.

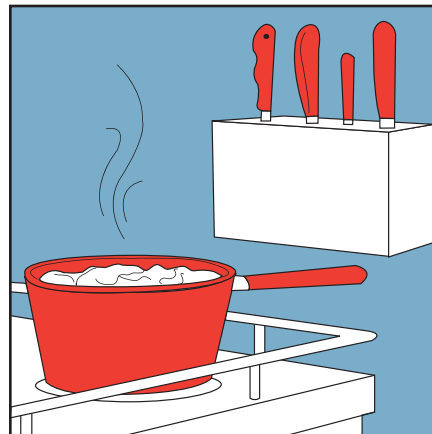

Use proper safeguards in the galley. Keep utensils secured in racks or drawers, and use a guard rail on the stove.

Waste synthetic material, rope, nets, lines, garbage bags etc. must not be thrown over the side. Synthetic materials can foul fishing gear and propellers and can kill fish.

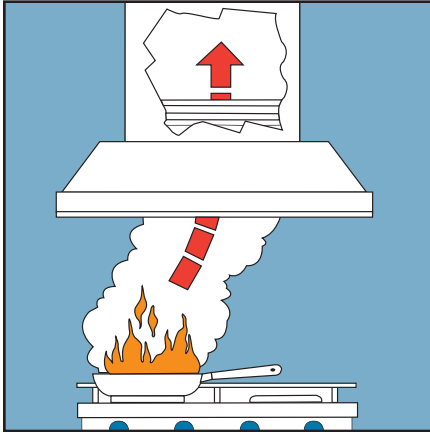

Degrease filters and stove ventilation trunking regularly.



Never leave a hot stove unattended. Grease or oil can easily ignite and cause a major fire.



Flammables should be stored in proper containers, away from crew quarters.

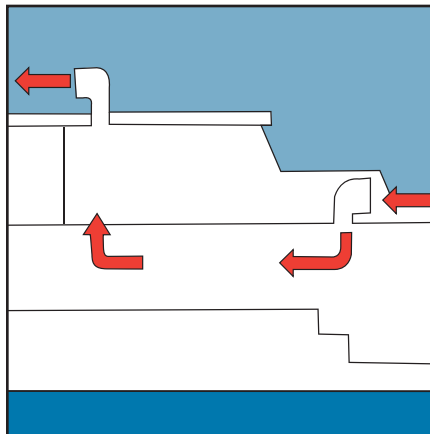

Make sure that all cabins and living quarters are well ventilated. Exhaust gases from the engine room can be deadly if allowed to build up.

Working Safely



Never jump. Always use the gangway or ladder when boarding or leaving the vessel.

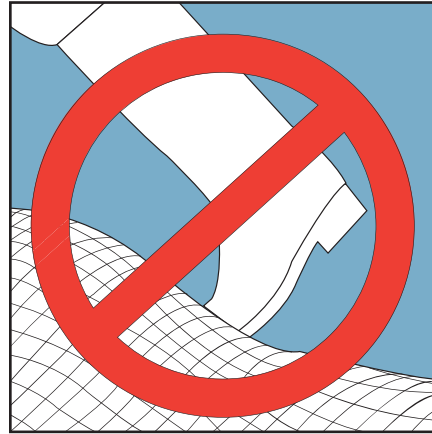

Be careful where you put your feet, especially when wires, ropes or nets are moving.

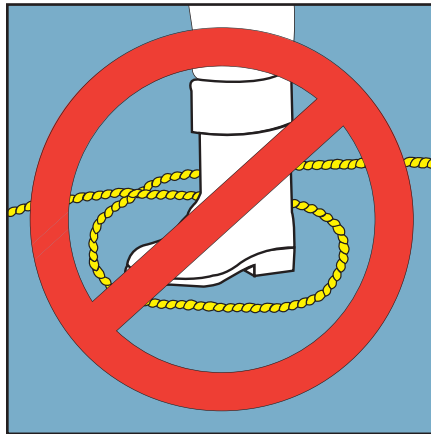

Never stand in a bight of rope or wire. If it tightens suddenly, a serious injury may follow.

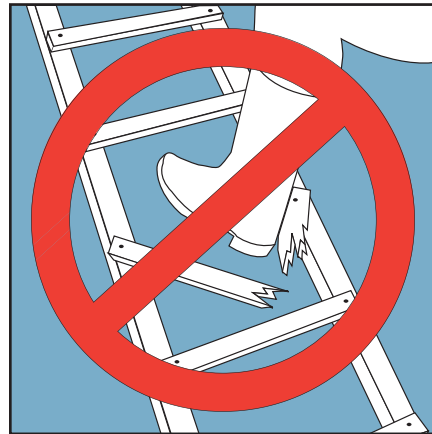

Always check ladders to be sure they are well constructed, secured and maintained.



Watch your head. Don't stand under a load, or in areas where overhead equipment may swing and cause serious injury.



Never bend your back over the load when lifting heavy weights. Stand with your feet a little apart, and keep your back straight.

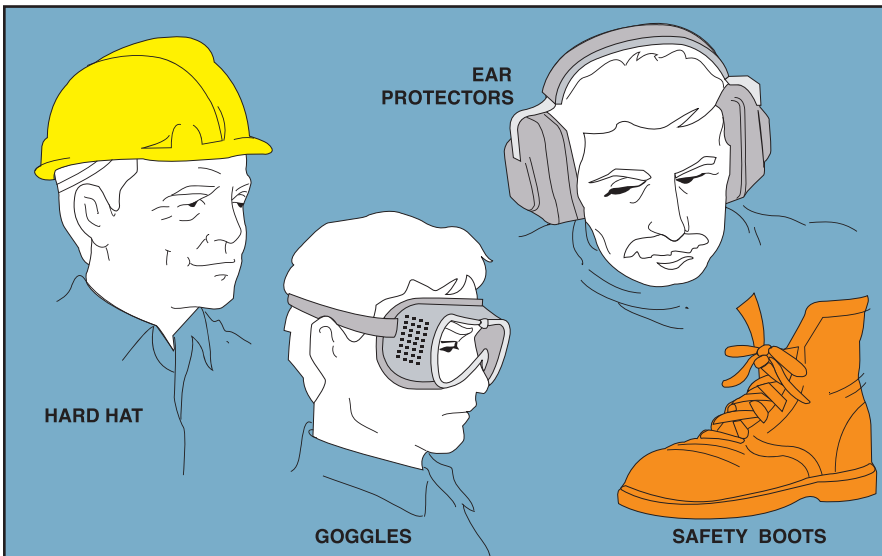

Wear proper safety equipment, and clothes suitable to the job.

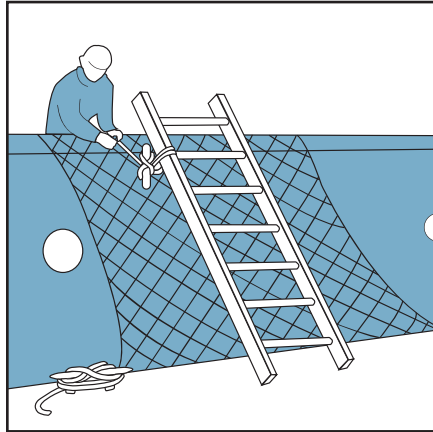

Portable ladders should be securely lashed. Safety nets should be spread before the ladder is used.

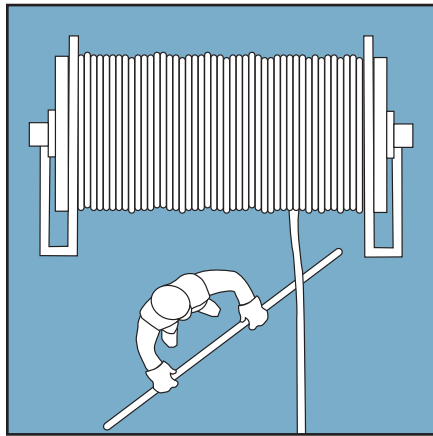

Never guide wire with your hands or feet.

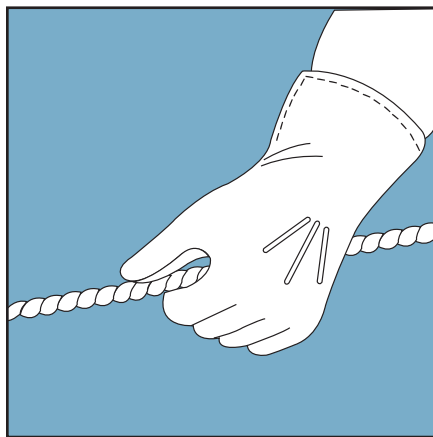

Always wear heavy gloves or mitts when handling wire rope.

Make sure that hatches and flush deck scuttles are properly covered when they are not in use.

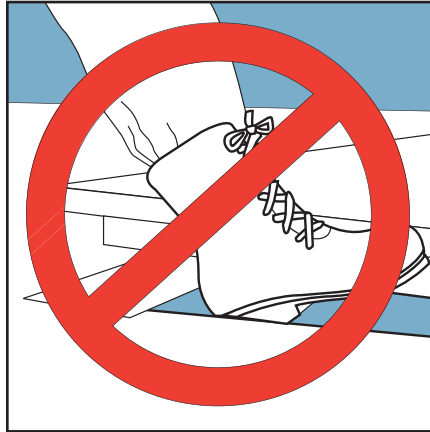

**Working
Safely**

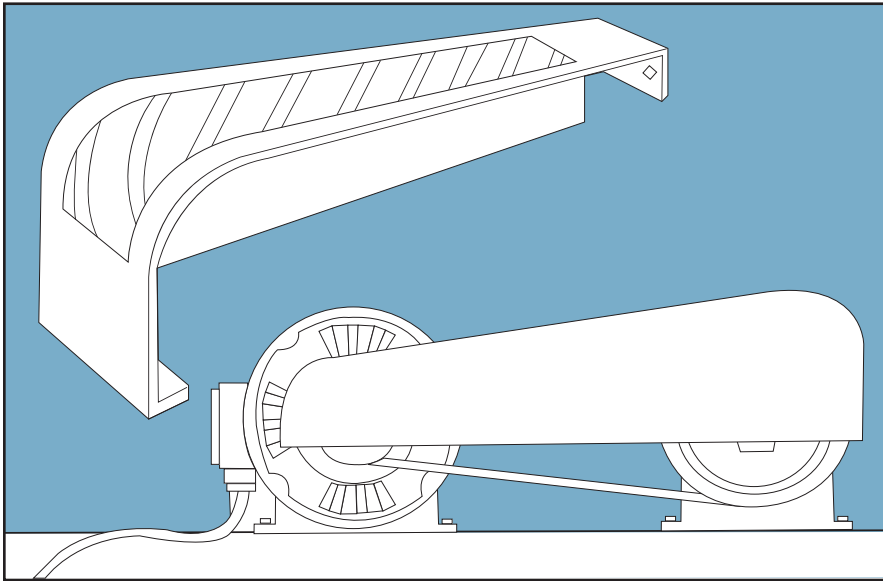

All belts and other moving parts of equipment should have proper guards fitted.

Working Aloft

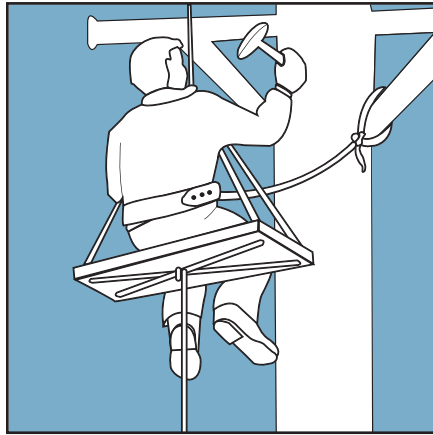

Use a bosun's chair and safety line when working aloft.

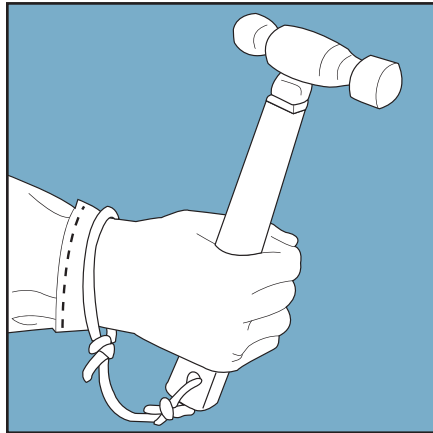

Tie off tools and parts when working aloft so they won't drop and injure those below.

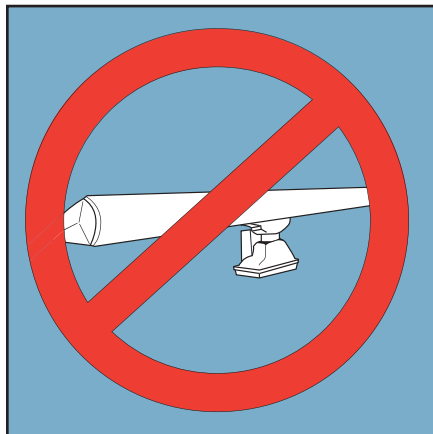

Make sure radar is turned off when working aloft. Radio antennae and radar scanners emit radiation, and a rotating scanner can cause serious injuries.

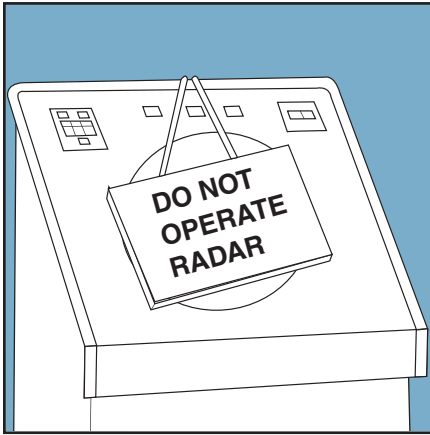

When anyone working aloft, place a sign "Do Not Operate Radar" on the radar control panel.

Directing Winch or Crane Operations

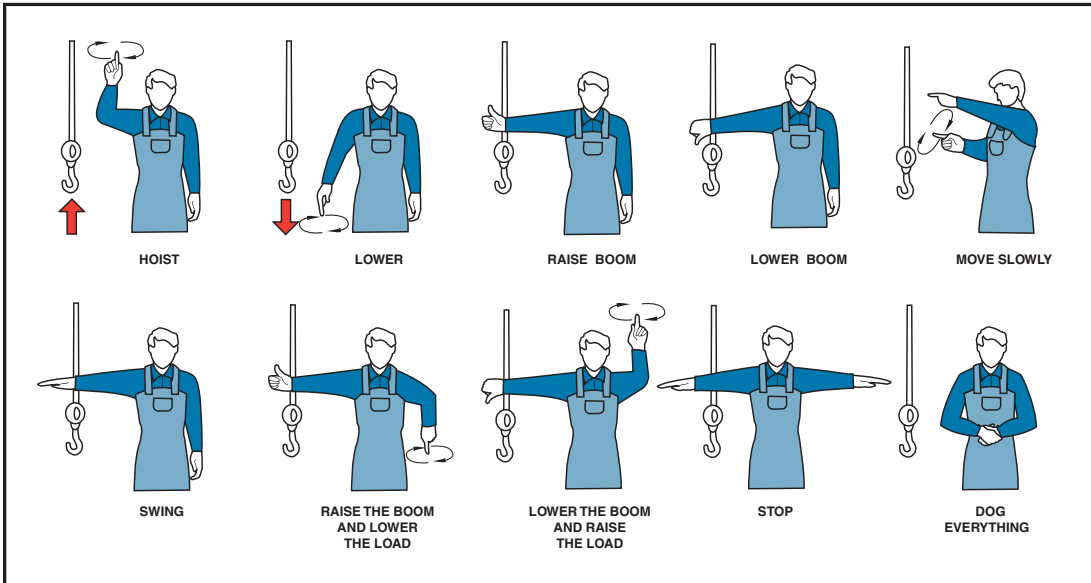

Fire Prevention

Nothing is worse than a fire at sea. Don't invite fires by letting rubbish accumulate in corners, or keeping things like paint or solvent in your cabin. Some common causes of fires are shown here. Be on the lookout for these hazards and correct them immediately.

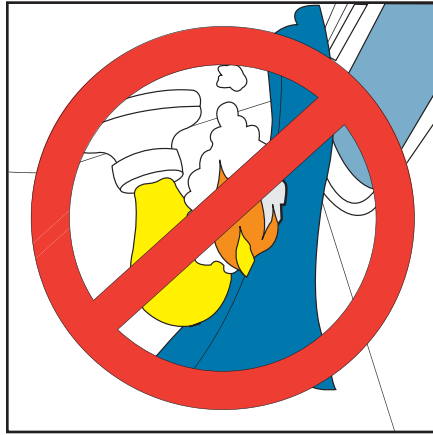

– exposed light bulb

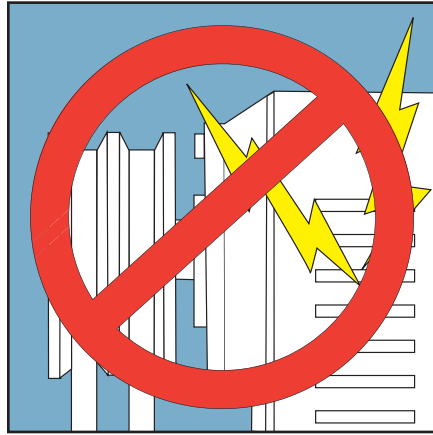

– arcing motor

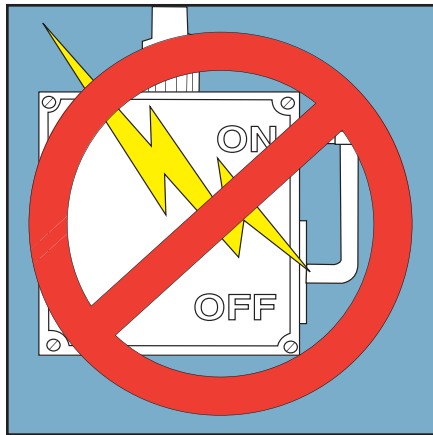

– faulty switch



– spark from a heavy tool dropping

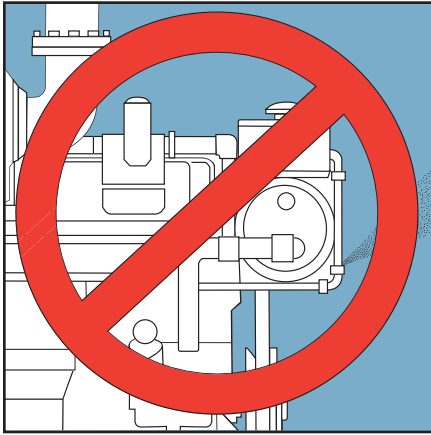

– ruptured fuel line



– damaged electrical cable

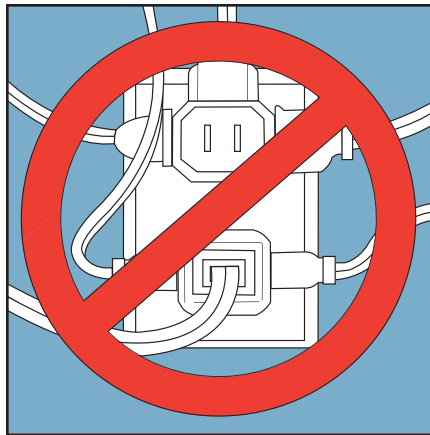

– overloaded plug outlet

**Fire
Prevention
(continued)**

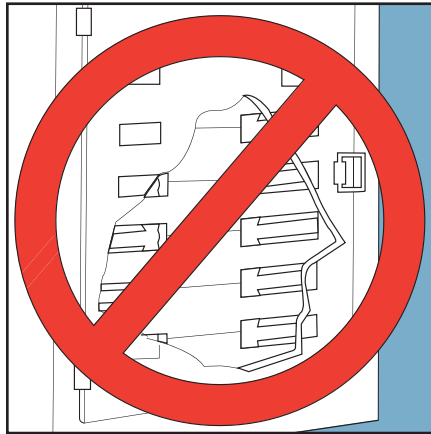

– bridged fuse



– smoking in unauthorised areas



– *Never* smoke in bed. Many people have died because they fell asleep while smoking.



– Oil-soaked rags are often overlooked. They don't *look* as if they could start a fire. But in fact, they *can* burst into flames by spontaneous ignition – without any other source of heat! *Always* store oily rags in a non-flammable container.

Refuelling Precautions

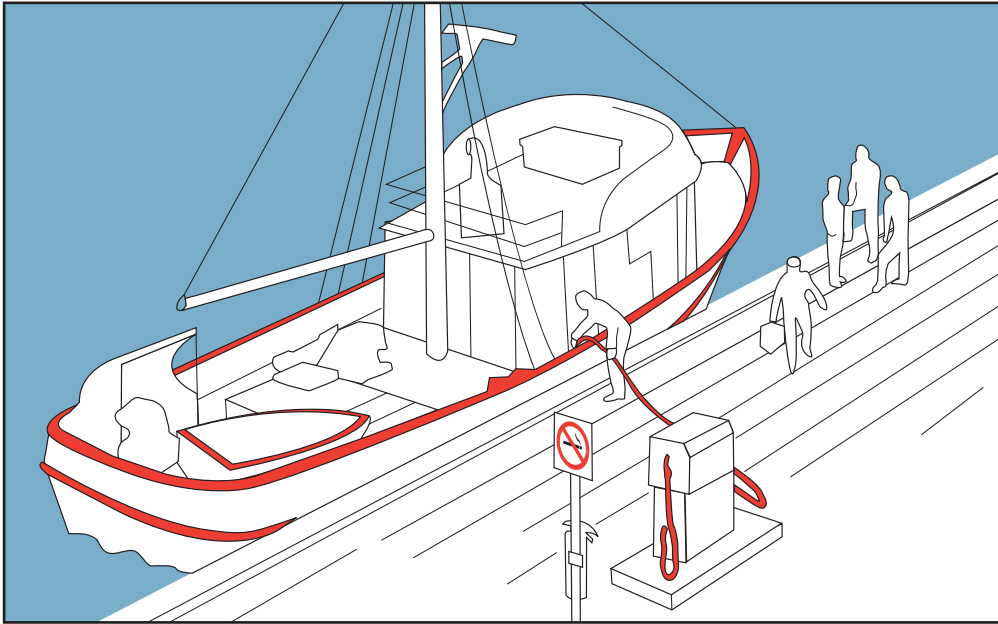

Extreme caution should be used while refuelling, because gasoline vapours are highly explosive. Use the following steps to refuel safely.

- 1) Moor vessel securely. Make sure an extinguisher designed for oil fires is handy.
- 2) Shut off engine. Anyone not involved with fuelling should leave the vessel.
- 3) Extinguish all cigarettes, stoves, heaters, or any other open flame. Turn off exposed lights.
- 4) Close hatches, doors and ports. Take portable tanks ashore.
- 5) Don't use electrical switches.
- 6) Ground the fuel nozzle against the filler pipe. Do not overfill the tank.
- 7) Wipe up any spills. Turn on the blower for at least five minutes, and ventilate cabins and enclosed spaces.
- 8) Check for vapour odours with a "sniffer" device and by smell.
- 9) Start engines, and allow crew to reboard.
- 10) Keep a fire extinguisher handy.

EQUIPMENT AND INSTALLATIONS

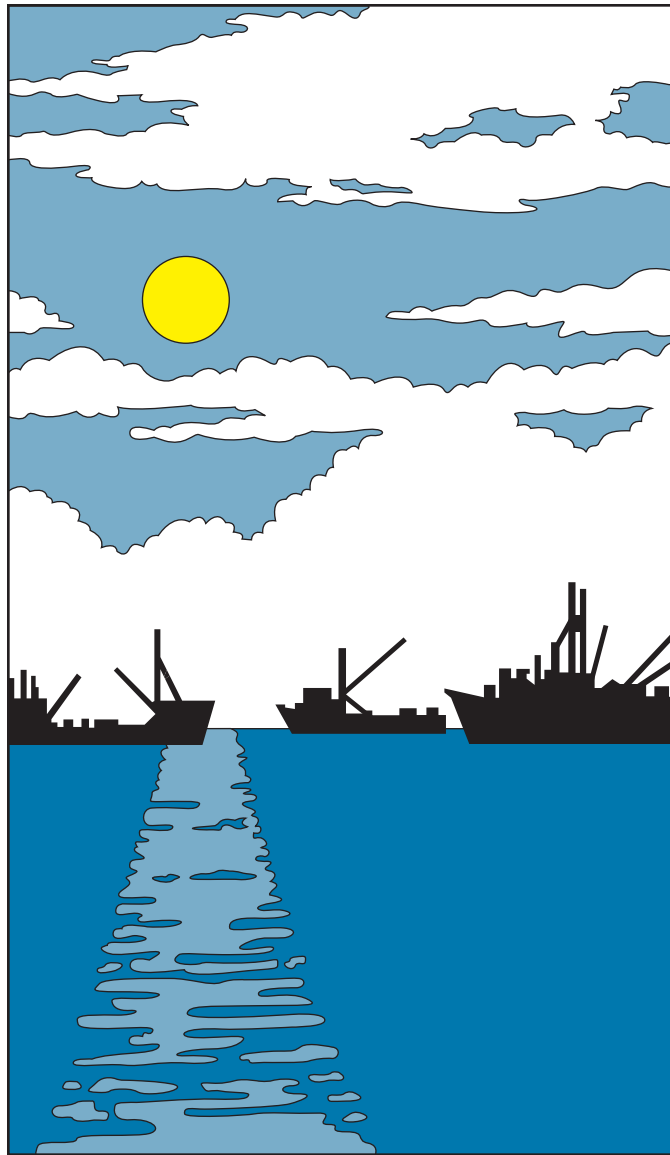

Equipment and Installations

A safe vessel is a well maintained vessel – all equipment must be installed correctly, and kept in good condition. Some key areas where hazards might develop are outlined below.

Bilge Installation and Maintenance

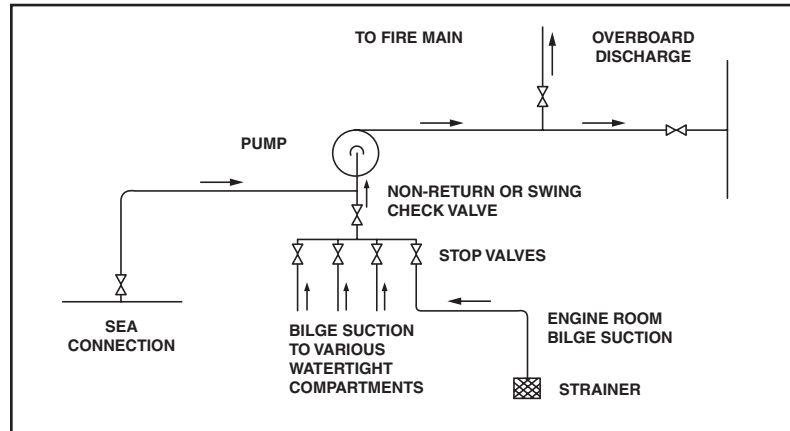

- 1) Keep bilges clean, pipes clear.
- 2) Keep bilge pump in good working order.
- 3) Keep bilges free from oil and fuel.
- 4) Keep the bulkhead tight to prevent flooding.
- 5) Use steel, bronze or similar piping, with flanged or screwed joints. Plastic pipe is only considered suitable in specific areas. Consult your local Marine Safety District Office for details.
- 6) A short length of plastic or rubber hose may be used if necessary to reduce vibration. If used, it must be clearly visible, strong enough to withstand suction, and joined with suitable clamps.
- 7) Fit drip pans under fuel pumps or fittings where there is a possibility of fuel leakage into bilges or similar areas, which may be an explosion hazard.
- 8) Check hull fittings to stop flooding.

Cover hot exhaust pipes from engines (as well as stoves) with a solid or perforated metal shield.

Use a large metal plate or other non-flammable cover to prevent hot exhaust pipes from setting fire to the deck.

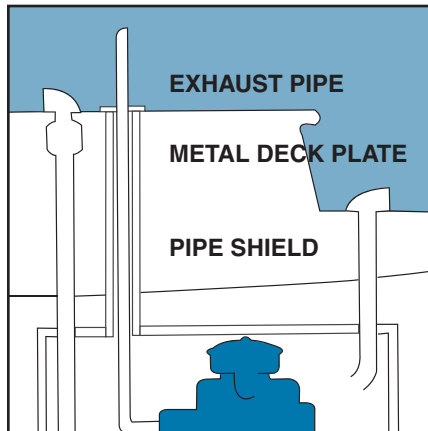

Exhaust Pipes

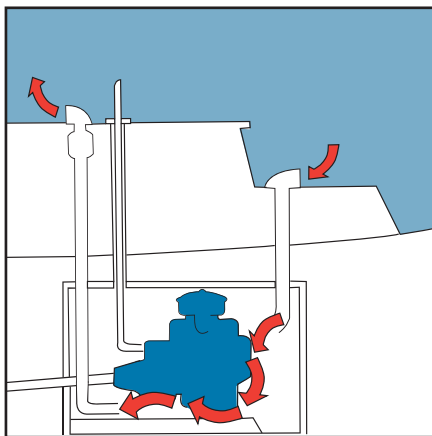

Many fires and explosions are caused by poor ventilation or backfire control.

Ventilation and Backfire Control

For proper ventilation:

- 1) Use at least one exhaust duct leading from the bilges, under the engine, to the surface.
- 2) Use at least one supply duct from the surface to a level below the engine air intake.
- 3) Place ducts far apart for good circulation.
- 4) Ducts may be fitted with wind-activated, self-trimming or rotary heads as well as power exhaust fans.
- 5) Turn on the fan at least 5 minutes before starting the engine.

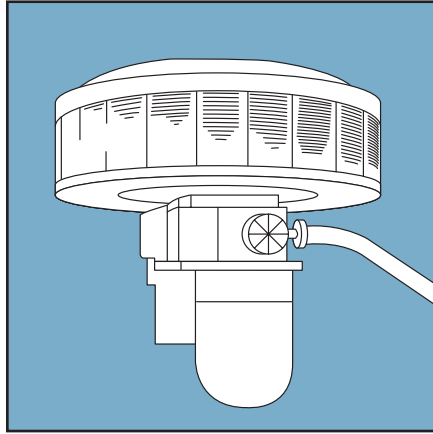

Flame arrestors help prevent dangerous backfires. Clean them often with soap and water.

Batteries

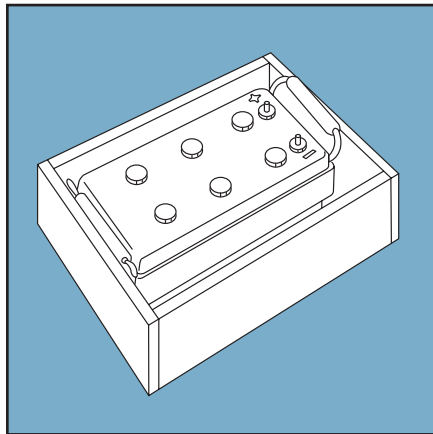

Batteries should be well secured and maintained in well ventilated areas that are easily accessible. Never locate batteries in crew quarters.

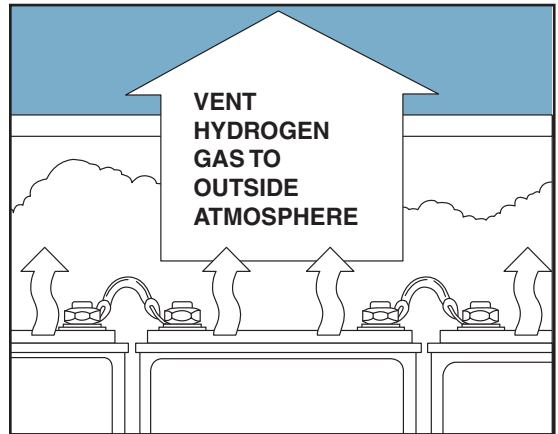

Batteries being charged give off explosive hydrogen gas. Smoking and open flames must be prohibited. The battery box should be made of material that will not corrode. Terminals should be protected against shorting out by metal objects.

Ropes and Tackle

Before working, always inspect the rope you will be using – whether it is a lifeline, gantline, or stage rope. Check for damage, and make sure it is right for the job. Your life may depend on it.

Know the safe working load of the rope, and don't exceed the limit.

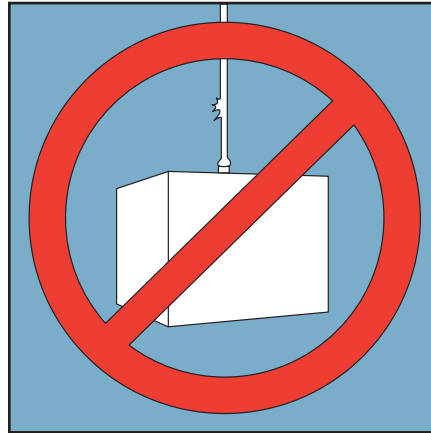

Fibre Rope

Abrasion will weaken a rope. Wrap and tie chafing gear around the rope where rubbing occurs.

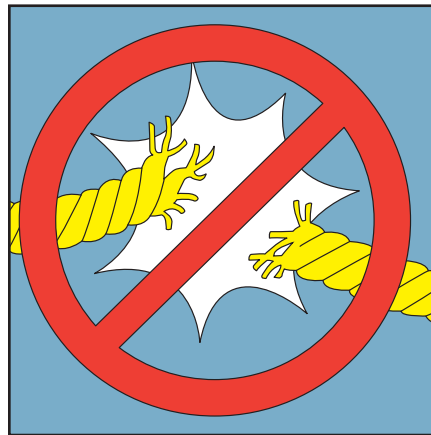

**Fibre Rope
(continued)**

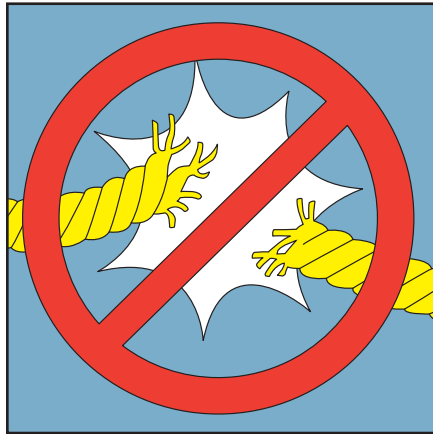

Avoid sudden strains or jerks, which can snap a rope.

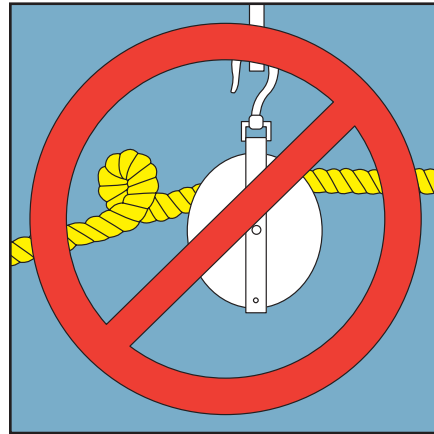

Never load a kinked rope or pull it through a block.



Never "fold" a rope or bend it sharply, or the fibres will be weakened.



Do not expose rope to oil, gasoline, paint or other chemicals. These can cause severe damage, especially to natural fibre rope.



Do not allow ropes to remain excessively soiled or dirty. Wash in clean water, and always dry natural fibre ropes before storage.

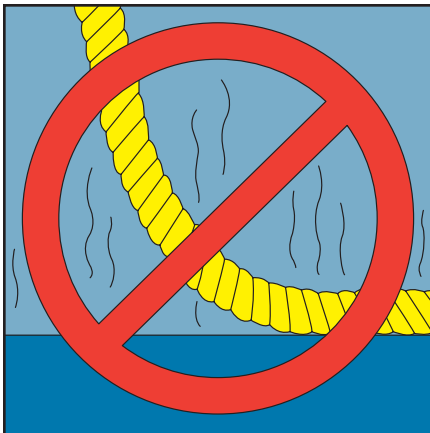

Do not let synthetic rope touch very hot surfaces, which will melt the fibres.

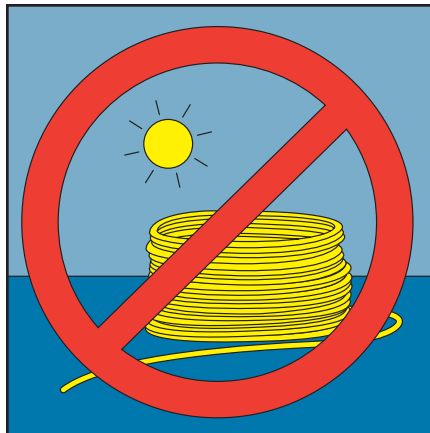

Do not store synthetic rope in direct sunlight, which can damage the fibres.

Synthetic Rope

Synthetic Rope (continued)

Synthetic ropes are stronger and last longer than natural fibre ropes. However, they are not suitable for some jobs. Synthetic rope should never be thrown over the side, and should be used with caution on a winch drum.

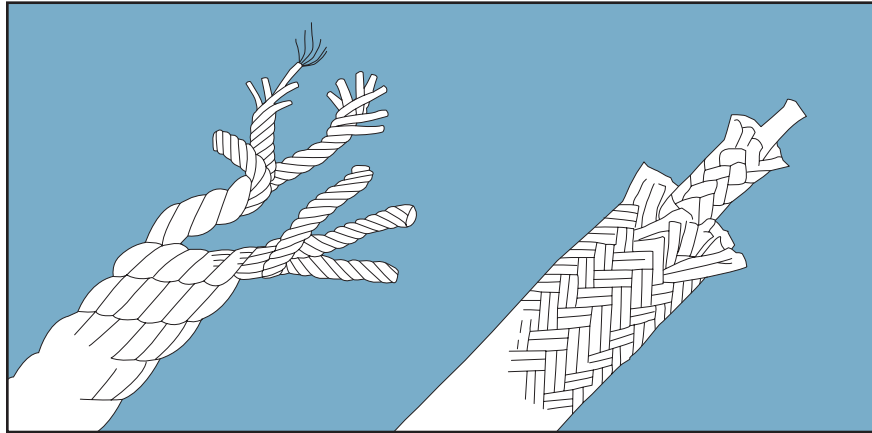

There are many different types of synthetic rope.

- 1) **Nylon** ropes are very strong and elastic. They can withstand shock loads that would break other fibres, but if they do break, the "snapback" can be dangerous. They resist weather and abrasion.
- 2) **Dacron** is second to nylon in elasticity, and it withstands abrasion very well. It will stretch only half as much as nylon under heavy loads.
- 3) **Polyester** ropes are slightly less strong than nylon or dacron, but they resist sunlight better.
- 4) **Polypropylene** ropes are the lightest kind of synthetic rope. They are reasonably strong, but deteriorate with sunlight. They should *not* be used with lifesaving devices.
- 5) **Polyethylene** ropes are not quite as strong as polypropylene ropes, but they float, which is an advantage for some jobs.
- 6) **Blends** of nylon, dacron, polypropylene and new fibres such as kevlar and mylar have the advantages of all these different fibres. Blended fibre ropes are being used more frequently, especially for rigging trawl nets.

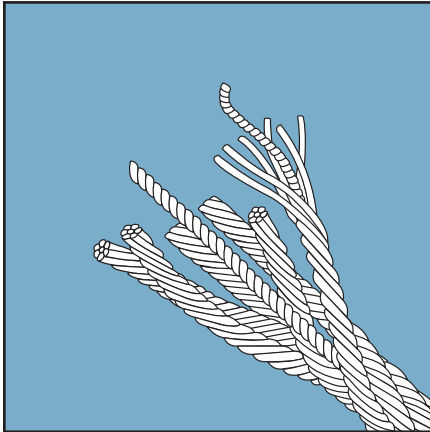

Wire rope should be inspected frequently and replaced if it shows signs of excessive wear:

Wire Rope

- rust
- broken strands of wire
- kinks
- overstretching
- reduction in diameter
- flattening

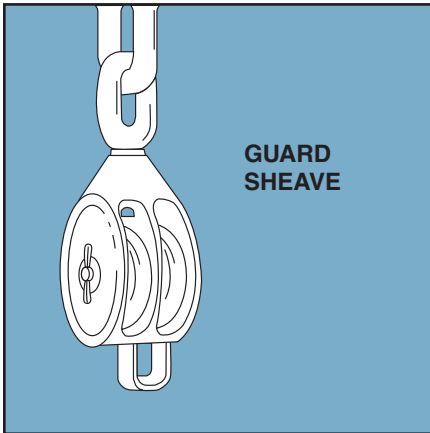

Sheaves should be properly guarded.

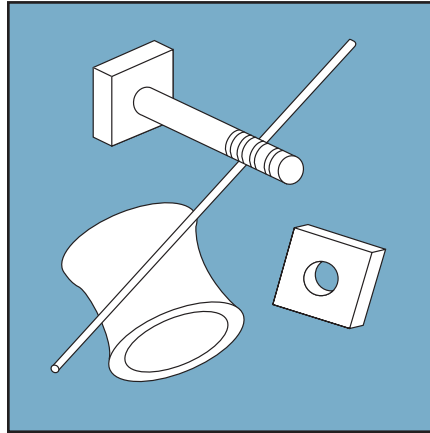

Block, Sheaves and Other Fittings

All pins, axles, rope grooves, plates, bushings, nuts and bolts should be inspected regularly for signs of wear.

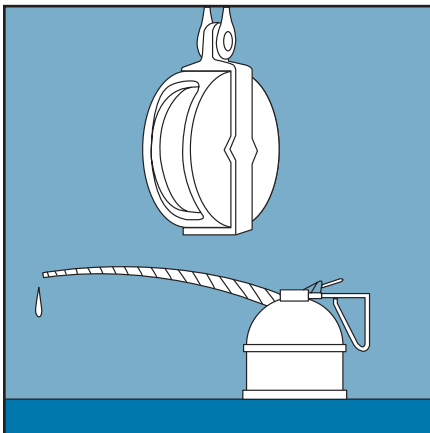

Blocks should be regularly inspected, lubricated and maintained. Wooden blocks are not recommended for use on fishing vessels.

Other Equipment

Be sure you know the location of all watertight and weathertight closures, and how to use them. Both watertight and weathertight closures should be inspected regularly. Report any defects to the master or operator immediately.

Watertight and Weathertight Enclosures



Keep all watertight closures closed unless actually in use, especially before oncoming heavy weather.

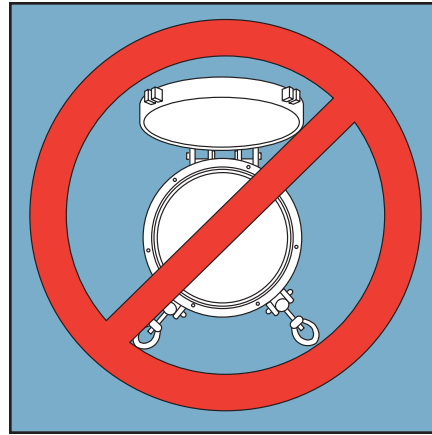

Always keep portlights and deadlights closed and secured when at sea.



Do not paint gaskets. Maintain all gaskets in good condition.

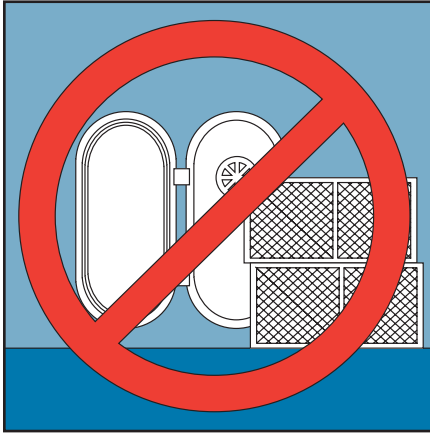

Do not allow cargo or deck gear to block weathertight closures, or any other doorway.

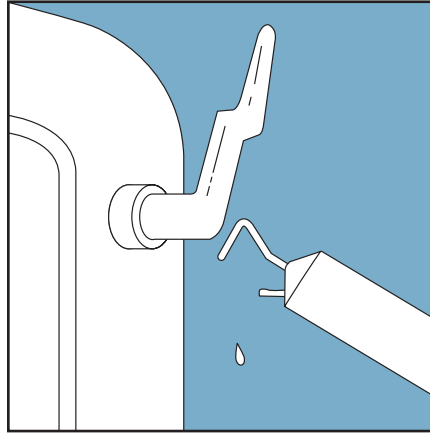

Inspect and grease all dogs regularly.

Propane and butane can be more dangerous than gasoline. These gases are heavier than air. If they escape, they collect in the lower parts of the vessel and are very difficult to remove.

Propane Appliances

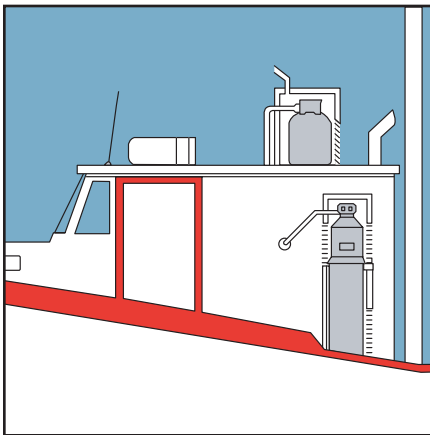

Make sure all propane appliances and cylinders are properly secured, protected and ventilated, so that escaping gas can not reach bilges or other enclosed spaces. The equipment installation should meet Federal Government standards.

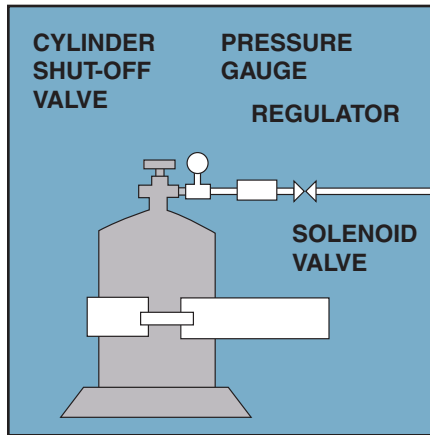

Make sure that all valves are working properly, and that all connections are tight.

Ladders



Avoid using portable ladders if at all possible.

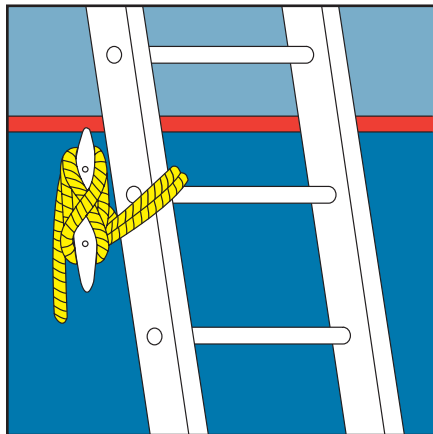

If you must use portable ladders, make sure they are tied off securely.

Anchors and Cable

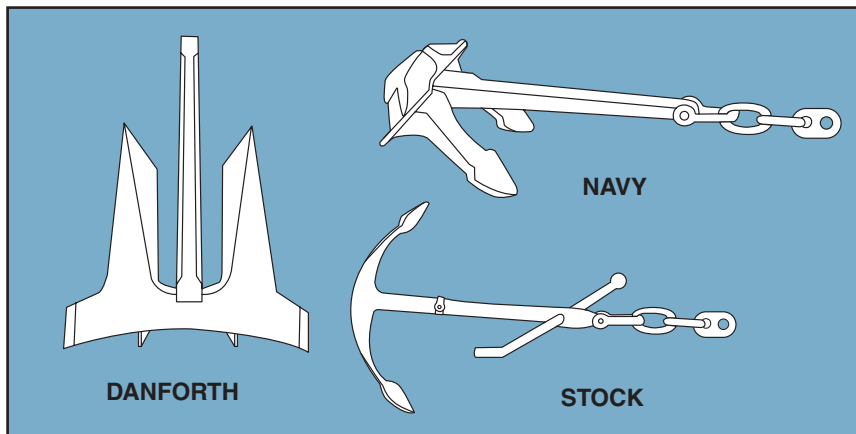

The weight of anchor you need depends on the length, breadth and depth of the vessel. Use approximately 6 metres of chain on the outer end of the anchor cable. The cable itself may be link chain, wire rope, manilla rope, other fibre rope of equal strength, or a combination of chain and rope.

The size and length of cable you need depends on the weight of the anchor. The table below provides some guidelines.

Weight of main anchor (kilograms)	Minimum diameter of chain or wire rope (millimetres)	Minimum circumference of manilla or other rope (millimetres)	Length of cable (metres)
1 or 2 anchors... 45	9.5	64	55 *
1 or 2 anchors... 90	12.5	89	55 *
1 or 2 anchors... 135	14.0	102	82
2 anchors... 180	16.0	114	100
2 anchors... 230	17.5	127	137
2 anchors... 270	19.0	127	137
*If two anchors are carried, the total length of cable shall be increased to 82 metres.			

VHF Radio

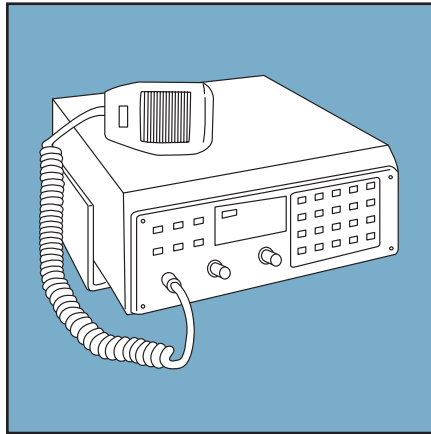

It is highly recommended to fit a VHF radiotelephone, or, where the service is available, a VHF installation with Digital Selective Calling (DSC). To determine the marine radio services available in your area, consult the DFO publication, Radio Aids to Marine Navigation, available at

http://www.ccg-gcc.gc.ca/mcts-sctm/ramn_e.htm.

Ships fitted with a VHF installation with DSC should connect the radio to their GPS or Loran C for automatic position updates. As well, the VHF DSC must have a valid Maritime Mobile Service Identity (MMSI). MMSI numbers are available free of charge from your local Industry Canada – Spectrum Management office. They are listed in the blue pages of the telephone directory or on the Internet at: <http://strategis.ic.gc.ca/SSG/sf01742e.html>.

Anyone who operates the VHF equipment must have a Restricted Operator's Certificate – Maritime. This certificate can be obtained through the Canadian Power and Sail Squadrons (CPS), delegated examiners or Industry Canada, Spectrum Management. Further information and a study guide are available through the CPS at <http://www.cps-ecp.ca>.

The operator of ship required by regulation to fit a VHF installation with DSC must have a Radio Operator Certificate – Maritime Commercial. This certificate is available from most nautical institutes.

LIFESAVING EQUIPMENT



Life Saving Equipment

Regulations require vessels to carry a variety of equipment for use in emergencies. Make sure you know where this equipment is stored, and how to use it.

For specific regulatory requirements, check the regulations that apply to your vessel.

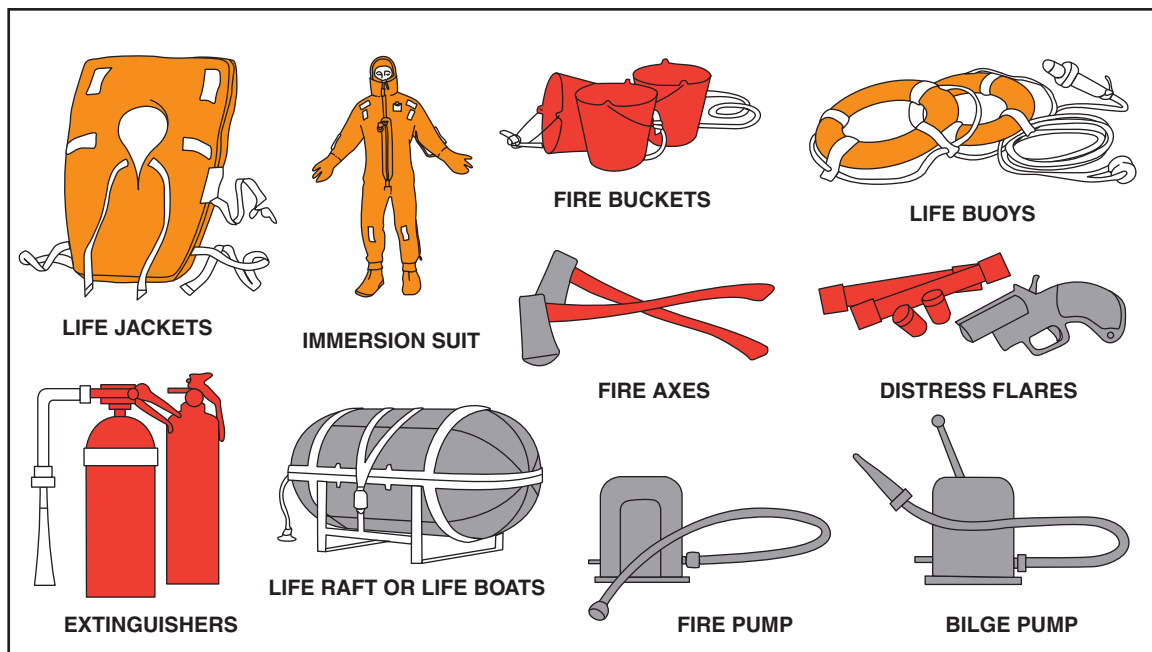

First Aid Kits



First aid can mean the difference between life and death. Fishermen are encouraged to take a first aid course, and all vessels must carry a proper first aid kit.

A first aid kit for up to five people should contain at least:

- 1 60 ml bottle of antiseptic wound solution,
or a 10-pack of antiseptic swabs.
- 1 pack of 10 disposable applicators (not needed
if antiseptic swabs are used)
- 1 disposable, waterproof vomit bag
- 12 adhesive bandage straps
- 2 2.5 cm x 4.5 m lengths of bandage gauze (not needed if ties
attached to dressing)
- 2 folded, 100 cm triangular bandages and 2 pins
- 2 sterile dressing compresses, about 7.5 cm x 12 cm
- 4 pieces of sterile dressing gauze, 7.5 cm x 7.5 cm
- 1 splinter forceps
- 1 current First Aid Manual (English)
- 1 current First Aid Manual (French)
- 1 eye pad with shield or tape
- 1 First Aid Record
- 1 pair of 10 cm scissors
- 1 roll of surgical adhesive tape, 1.2 cm x 4.6 m
(not needed if ties attached to dressing)
- 1 30 ml bottle of antipuritic lotion or a 10-pack of antipuritic swabs
- 1 elastic bandage, 7.5 cm x 5 m
- 1 pocket-size emergency blanket
- 1 container of hand cleanser or packet of cleaning towelettes
- 1 splint with padding
- 1 10 cm x 10 cm burn dressing

Fire Extinguishers

Fire extinguishers should be easily reached. Everyone on board should know where they are and how to use them.

There are several different types of fire extinguishers for use in extinguishing different types of fires. These are shown in the table below.

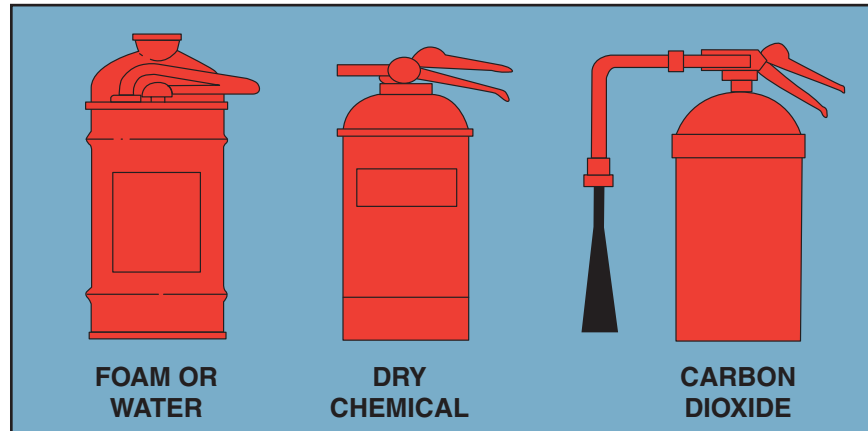

All extinguishers should be visually inspected each month, and serviced once a year. All carbon dioxide extinguishers should be weighed annually. Dry chemical extinguishers should occasionally be turned upside down and shaken.

A hydrostatic test should be performed:

- every 12 years for pressure type extinguishers
- every 5 years for carbon dioxide and water extinguishers
- after discharge for any extinguisher 5 years old or older

Life Jackets

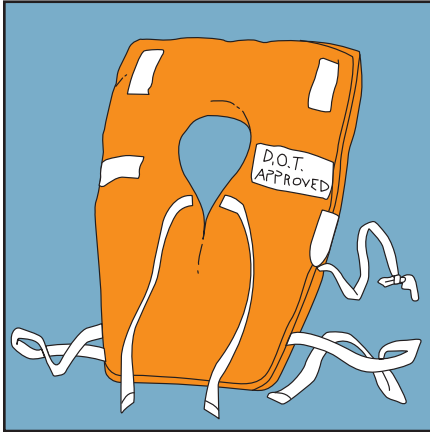

If the inside of the lifejacket becomes waterlogged, the jacket is no longer usable. Get a replacement.

An approved lifejacket for each person is mandatory on all fishing vessels. **Do not abuse it** by using it as a seat cushion, boat fender or kneeling pad.

When dry, store the lifejacket in a cool, well ventilated area.

If it gets wet, hang it up to dry in a well ventilated area before storing. **Do not dry** it in front of a radiator or other source of heat.



Try out the life jacket **before** an emergency occurs. Follow donning instructions on jacket. Never wear clothing over the jacket.

Before entering the water, make sure the jacket is secured and hold the neck piece down with both hands. enter the water feet first.

Immersion Suits

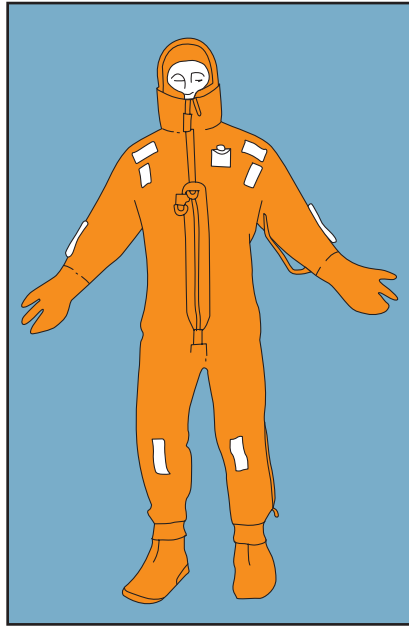

IMMERSION SUIT

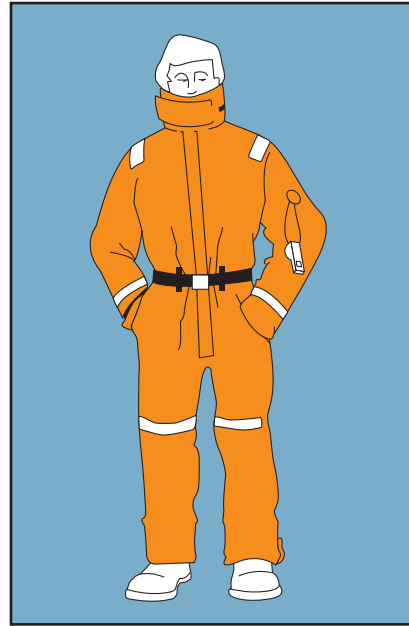

ANTI-EXPOSURE SUIT

Immersion suits provide the best protection from cold and exposure in the water. Only Transport Canada approved suits should be used.

If you have a suit, don't wait for an emergency. Try it out so that you will know how it works.

Take the suit out of its container, and pull it on as you would coveralls.

Pull the hood over your head, close the zipper with a slow, even pull, and then close the face cover.

Inflate the life-ring (if applicable) after you enter the water.

Cross your arms and hold onto your shoulders, and enter the water feet first.

You should take the suit out of storage occasionally to air it and to lubricate the zipper.

Life Rafts

If you have an inflatable life raft, be sure it is installed properly.

- 1) Install the raft where it can be easily launched, but where it will float clear if the ship sinks before launching.
- 2) Do not install the raft vertically. The gas cylinder inside will fall to the bottom and chafe the fabric. Install it in a cradle or shaped bed, secured with a senhouse slip and weak link or a hydrostatic release.
- 3) The painter must be secured to a strong point on the vessel.
- 4) The raft should not be exposed to paint, exhaust smoke, sparks, heavy seas or spray.
- 5) Have the liferaft inspected and repacked and the hydrostatic release tested according to the recommendations and requirements of the manufacturer.

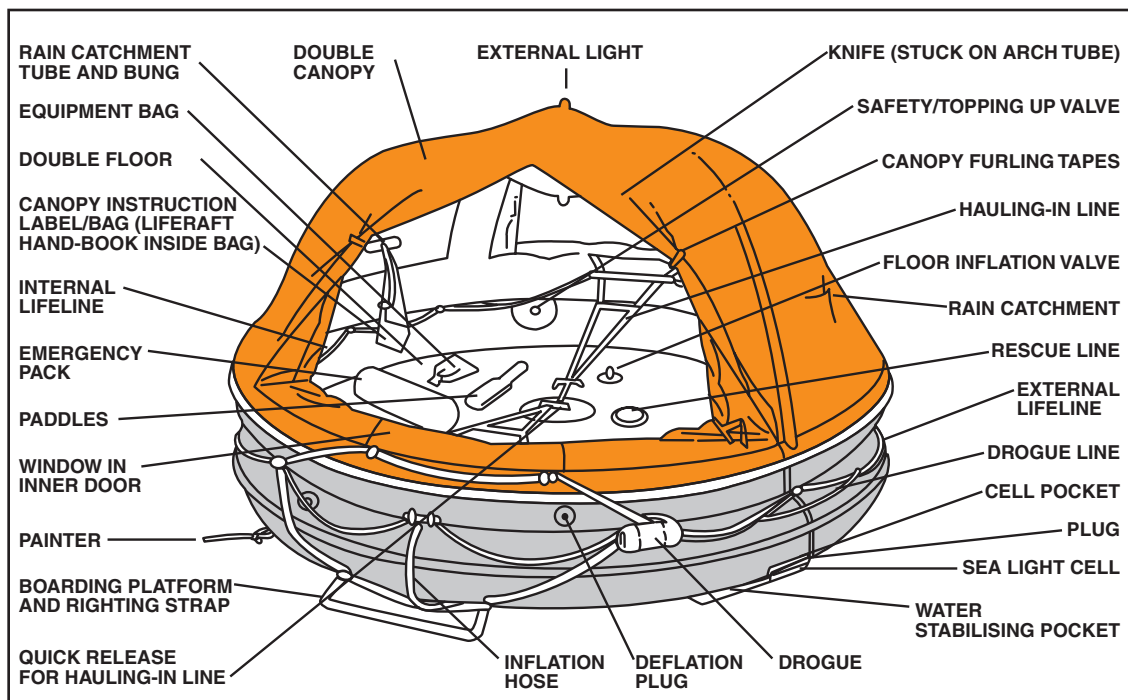

Make sure that everyone on board knows how to launch the raft properly.

- 1) Check to ensure that the launching area is clear of people and obstructions.
- 2) Two people should grasp the container at the ends, and toss it over the lee side of the vessel.
- 3) After launching, pull the painter until it is fully withdrawn and the raft inflates.
- 4) If the raft over inflates, you will hear the sound of air escaping.
- 5) If the raft inflates upside down, it must be made upright before boarding.

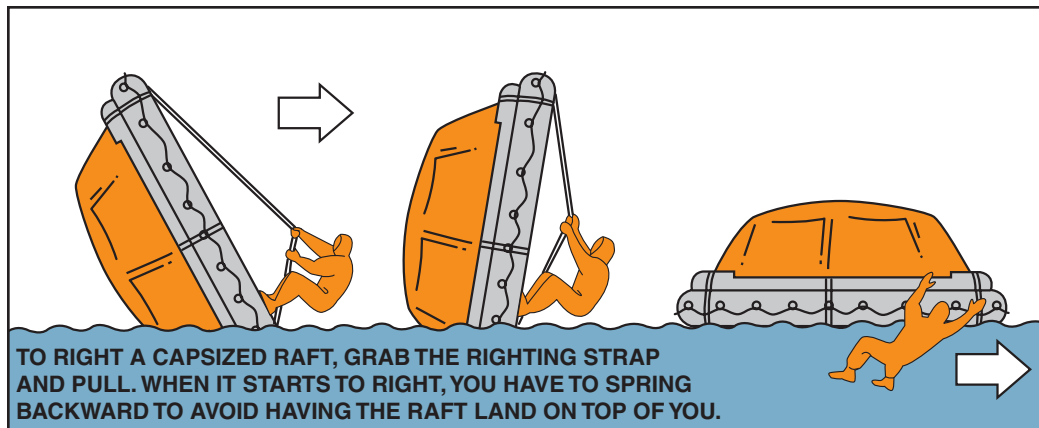

Boats

Some Fishing Vessels are equipped with small boats or skiffs. Such boats should be equipped with:

- one set of oars
- one set of crutches (oar-locks)
- one boathook
- a plug for each plughole
- one bailer
- one hatchet with lanyard
- one painter

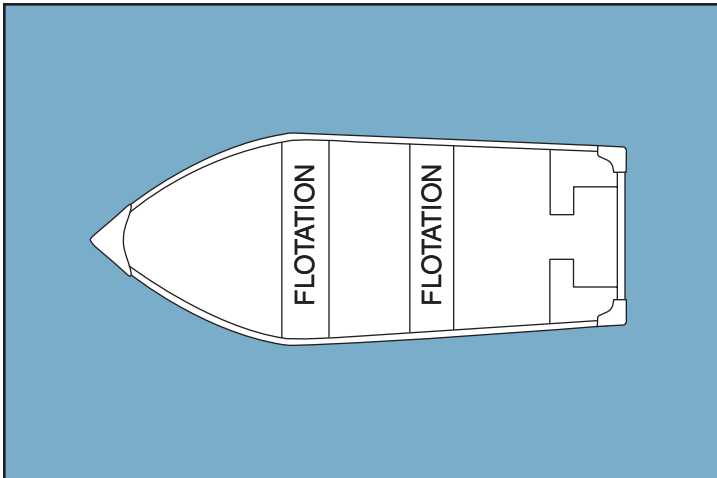

* Additional equipment may be required dependent on the size of vessel and the type of voyage. Please contact your local Marine Safety District Office for more information.

Distress Flares Fishing vessels are required to carry flares as described below.

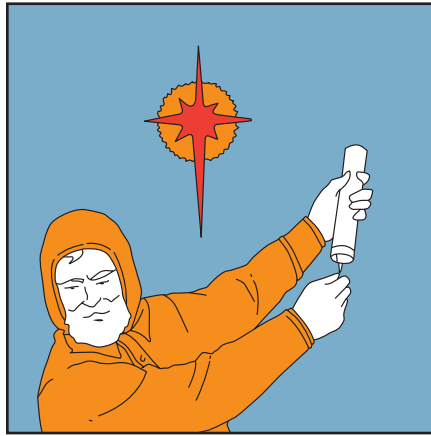

The Parachute flare is easily seen from the surface or the air, and burns at least 40 seconds.

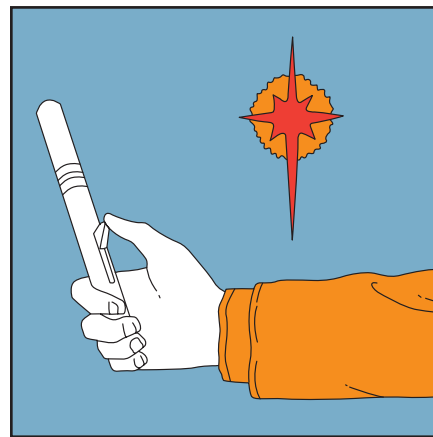
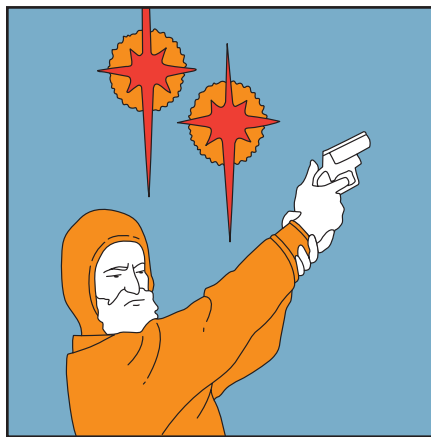

The "Multi-star" flare is also easily seen from the surface or the air. It burns four to five seconds. (If a single star shell is used, two shells should be carried for every flare.)

- * For specific Regulation Requirements check the Regulations that apply to your vessel.

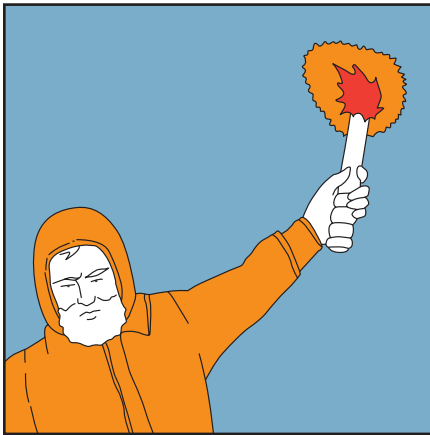

The hand held flare is less easily seen from the surface. (When using this flare do not look at it directly, and hold it downwind and well clear of the vessel.)

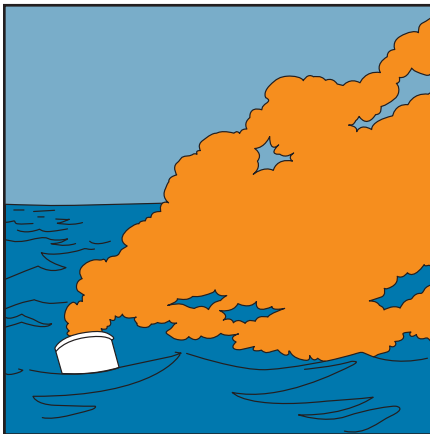

The smoke flare is used as a day distress signal only. It may not be mandatory for your vessel.

All flares should be stored in a watertight container, in a cool dry location. ***Flares are valid for four years from date of manufacture***, and should be disposed of after that time.

For disposal of outdated flares, contact a fire department, or the local police for advice.

EPIRB

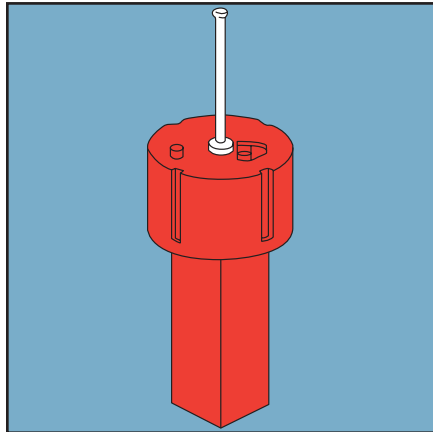

An Emergency Position Indicating Radiobeacon (EPIRB) is mandatory on many vessels. Even if it is not mandatory, it is highly recommended. Transport Canada encourages the carriage of 406 MHz EPIRBs as a very effective means of sending a distress alert.

When activated, the battery operated EPIRB transmits a signal that is recognized as a positive indication of distress by Search and Rescue forces throughout Canada and the world. The EPIRB may one day save your life.

You should:

- Read all instructions carefully and know how it works
- Register your EPIRB and keep the registry information up to date (1-800-727-9414)
- If a float-free model, mount the EPIRB in a place where it can float free. Do NOT attach the lanyard to your ship
- Test the EPIRB in accordance with regulations and the manufacturer's instructions
- Perform regular maintenance, including battery and hydrostatic release replacements, as recommended by the manufacturer.

WEATHER INFORMATION

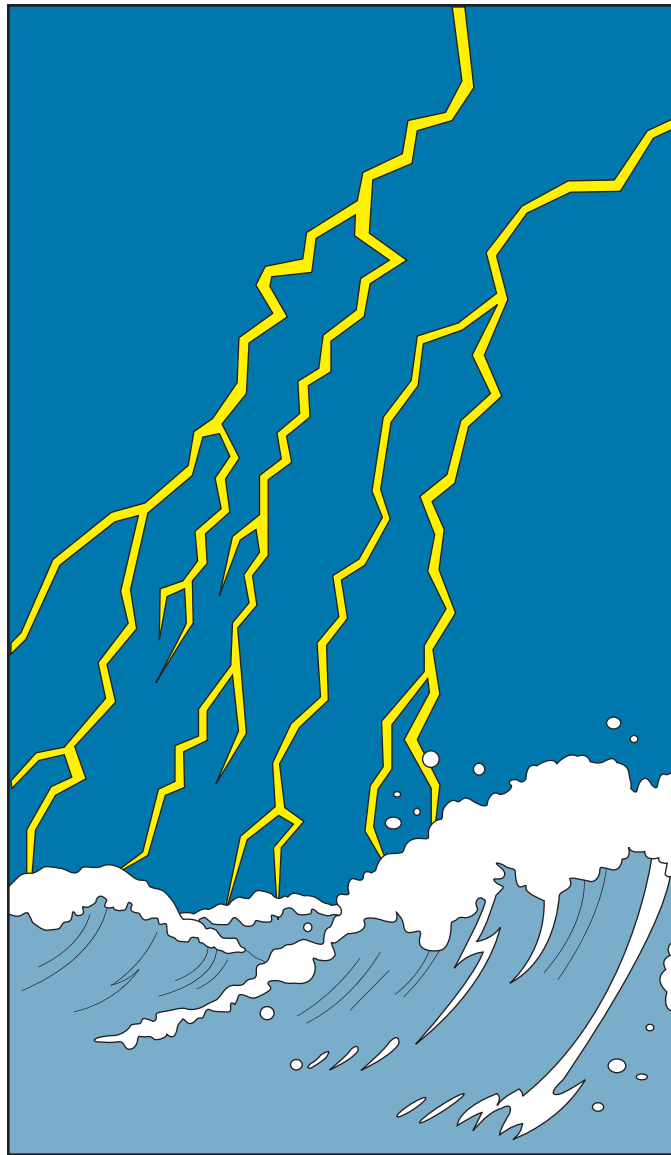

Weather Information

Marine weather forecasts are available on:

- VHF Channel 21B and 83B (Atlantic Coast and Great Lakes)
- VHF Channel 21B and WX1, WX2, WX3 (Pacific Coast)
- Environment Canada Weather radio VHF broadcasts in Vancouver, Toronto, Montreal and Atlantic Canada
- Regular AM and FM radio weather forecasts
- The Marine Weather Services Bulletin, obtained by calling the nearest Environment Canada weather office
- MAFOR Code on the Great Lakes and St. Lawrence River (see *Radio Aids to Marine Navigation*)
- http://weatheroffice.ec.gc.ca/warnings/warnings_e.html.

A receiver for continuous weather forecasts is available through marine supply outlets.

Marine weather forecasts include four types of severe weather warnings: small craft, gale, storm, and hurricane force winds. The meanings of these warnings are described below.

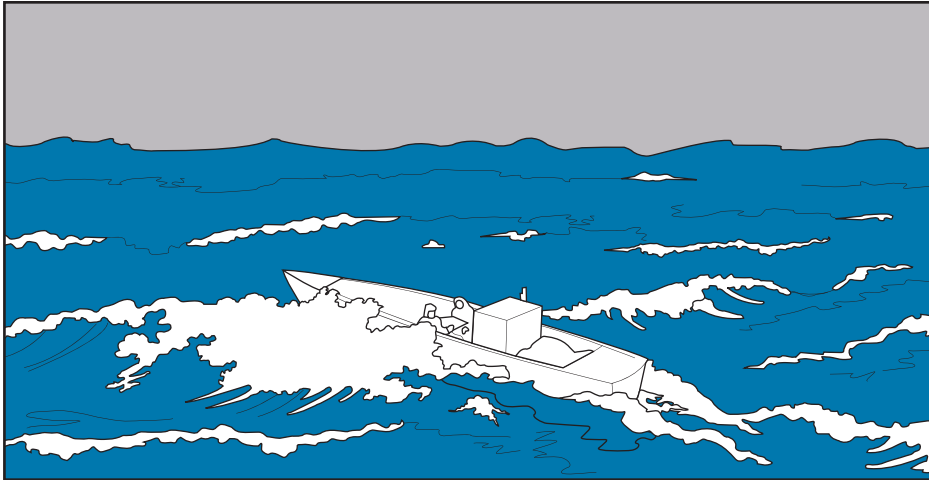

Small Craft Warning

Winds 20 – 33 knots

Wave Heights 2 – 3 metres

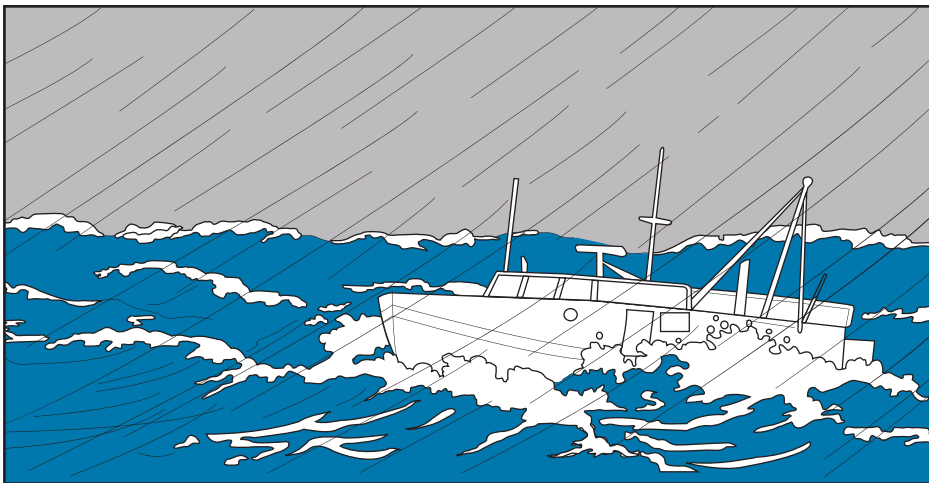

Gale Warning

Winds 34 – 47 knots

Wave Heights 6 – 9 metres

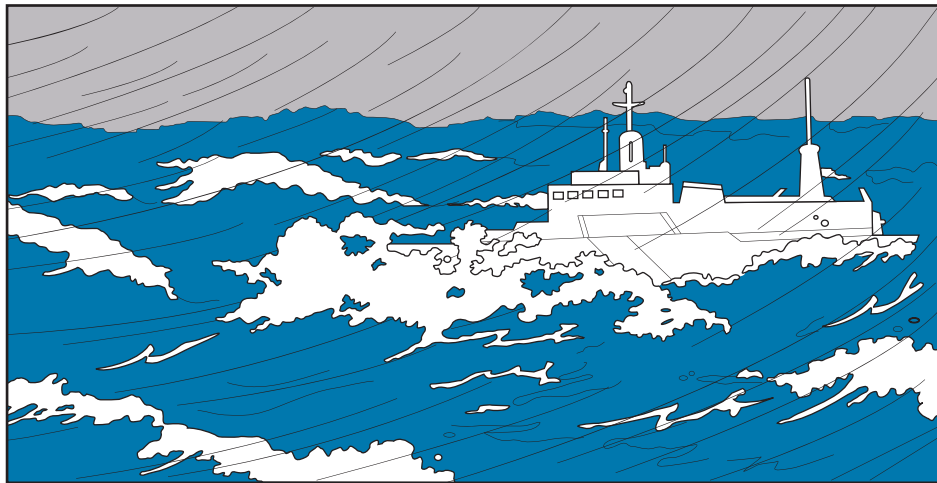

Storm Warning

Winds 46–63 knots

Wave Heights 9–16 metres

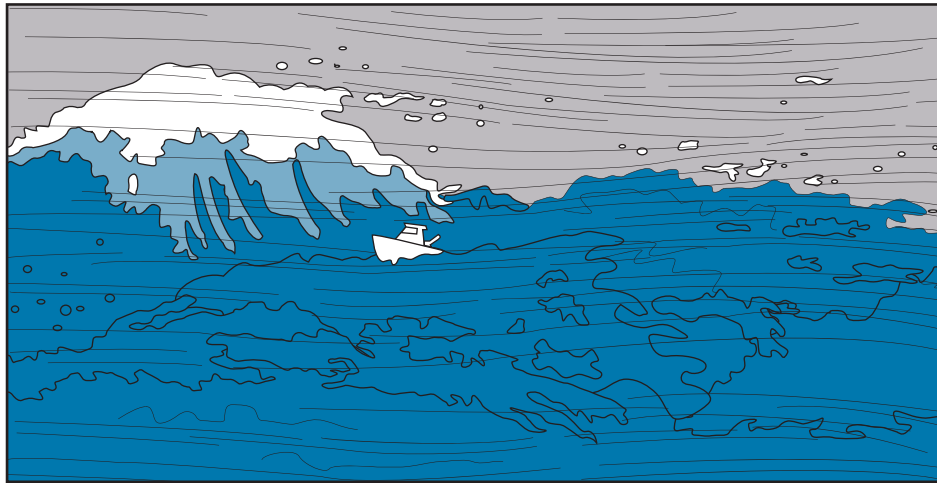

Hurricane Force Warning

Winds 64 knots and over

Wave Heights over 16 metres

Severe seas of any kind are dangerous if you are not prepared. You should take special care in the following situations.

Severe Sea States

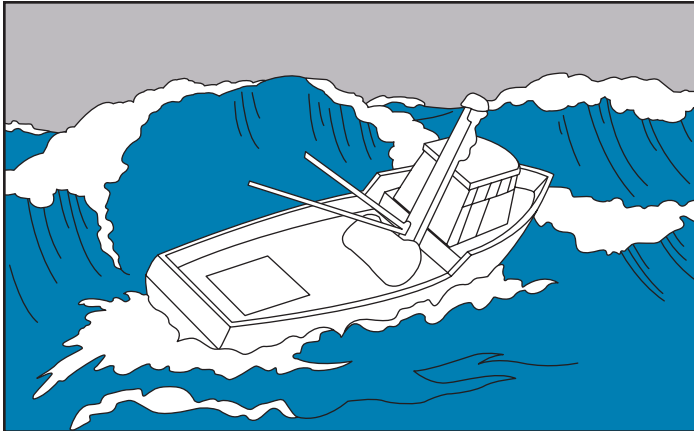

In beam seas, excessive roll can cause cargo to shift, creating a dangerous list. This could cause the vessel to capsize. Strong breaking waves could also capsize the vessel.

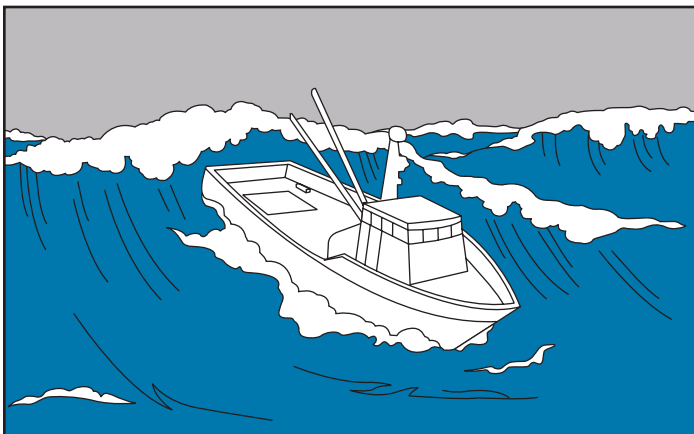

In following seas, a vessel may lose stability on a wave crest. If the vessel is overtaken by a wave crest, broaching may occur.

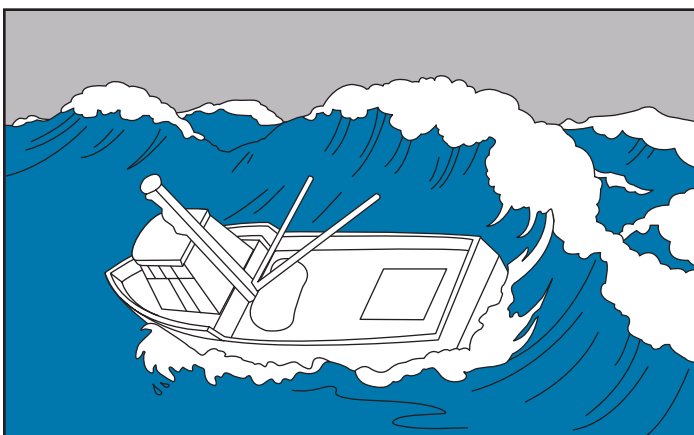

In quartering seas, the problems of beam and following seas are combined. Quartering seas represent the most dangerous situation in severe weather.

Thunderstorms

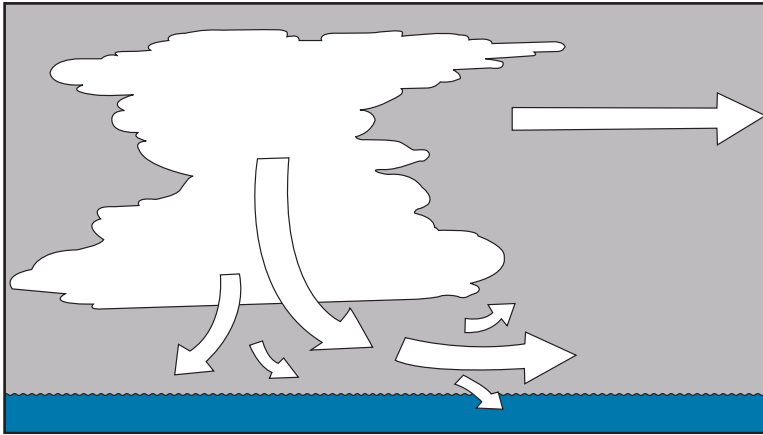

The strongest winds in a thunderstorm usually precede the storm centre itself, in a zone up to three miles long. Gusts up to 50 knots can be expected in this zone. The winds blow downwards from the cloud, and they are especially dangerous for small vessels.

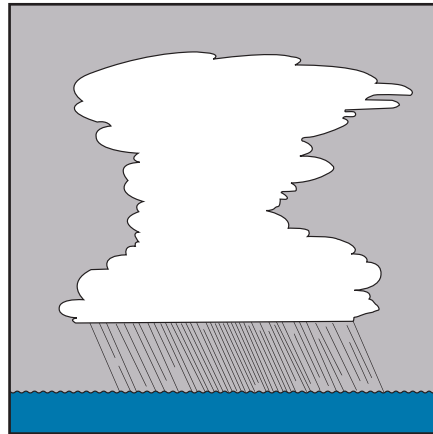

The heaviest rain occurs directly under the thunder cloud, leading to poor visibility. Heavy rain lasts from five to 15 minutes. Thunderstorms normally last less than one hour.

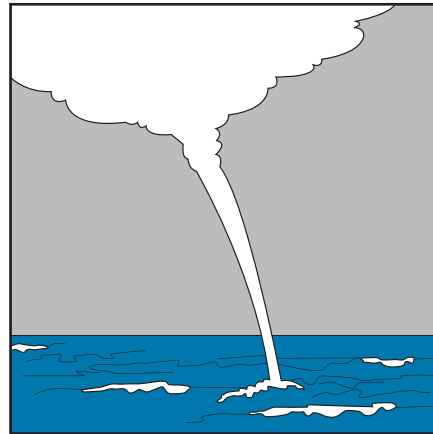

Waterspouts may occur during a thunderstorm. A waterspout is a funnel of cloud reaching from the base of the thunderstorm cloud to the water, which may suck up water into the air. It usually lasts less than 15 minutes. Although immature waterspouts may be very small, they can become extremely violent without warning.

Fog and Snow

Fog is a common problem at sea. The major hazard is reduced visibility. Vessels should proceed with caution, and monitor radar carefully.

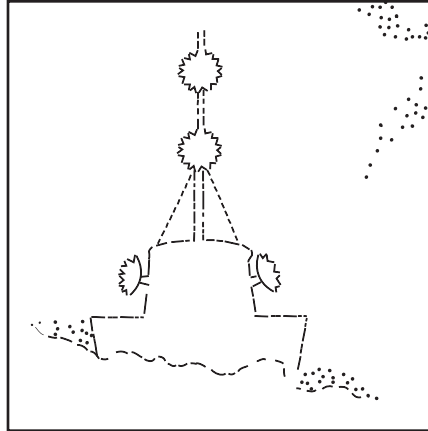

Snow also reduces visibility, and can be especially hazardous if it falls as melting snow. Melting snow not only reduces visibility, but interferes with radar signals making radar less effective. This usually occurs during arctic air outbreaks, and is a serious problem in mainland inlets.

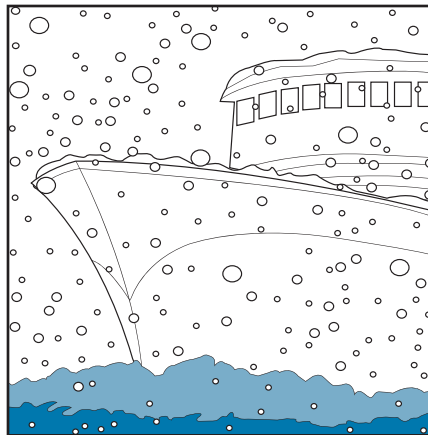

Icing Accumulations of ice on a vessel may lead to serious stability problems. Substantial icing can occur when temperatures are between -3 and -8 degrees Celsius with winds 16–30 knots. The danger increases with colder temperatures or stronger winds.



Freezing sea spray is the most common and the most hazardous form of icing. Spray blown by winds can cause heavy icing on a vessel, producing a heavy list. Freezing spray usually occurs when the air temperature is less than -2 degrees Celsius, and the water is less than 5 degrees Celsius. Freezing spray warnings are included in marine weather forecasts.

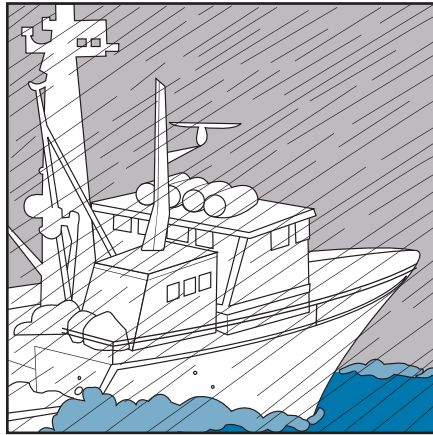

With **freezing rain**, a film of ice forms over the decks, railings and stairways. This form of icing is the least likely to cause stability problems, but it can be a serious hazard for the crew moving on deck.

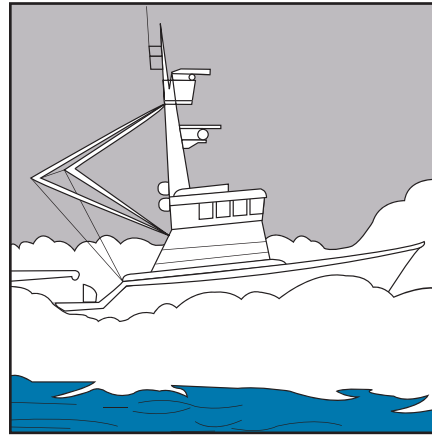

A similar glaze of ice can be caused by sea smoke. Sea smoke forms when very cold air moves over warmer water, and it can freeze on contact with the vessel. It is not usually a severe problem, but if the sea smoke is very dense substantial ice may accumulate.

Metric Conversion Tables

Marine weather forecasts originating outside Canada may not use metric measurements. The following tables will be useful when interpreting these forecasts.

Wave Height	
Metres	Feet
1	3
2	7
3	10
4	13
5	16
6	20
7	23
8	26
9	30
10	33
15	49
20	66

Barometric Pressure		
Millibars	Kilopascals	Inches
950	95,0	28,1
970	97,0	28,6
990	99,0	29,2
1 000	100,0	29,5
1 013	101,3	29,9
1 020	102,0	30,1
1 040	104,0	30,7
1 060	106,0	31,3
Note : "Normal" atmospheric pressure is 1 013 millibars.		

Beaufort Scale

Beaufort Wind Force	Mean Wind Speed in knots	Limits of wind speed in knots	Descriptive Term	Sea Criterion	Probable height of waves in metres*	Probable max. height of waves in metres*
	Measured at a height of 10 m above sea level.					
0	0	<1	Calm	Sea like a mirror.	–	–
1	2	1–3	Light air	Ripples with the appearance of scales are formed, but without foam crests.	0.1	0.1
2	5	4–6	Light breeze	Small waves, still short but more pronounced, crests have a glassy appearance and do not break.	0.2	0.3
3	9	7–10	Gentle breeze	Large wavelets, Crests begin to break. Foam of glassy appearance. Perhaps scattered white horses.	0.6	1
4	13	11–16	Moderate breeze	Small waves, becoming longer, fairly frequent white horses.	1	1.5
5	19	17–21	Fresh breeze	Moderate waves, taking a more pronounced lingo form: many white horses are formed. (Chance of some spray.)	2	2.5
6	24	22–27	Strong breeze	Large waves begin to form; the white foam crests are more extensive everywhere. (Probably some spray.)	3	4
7	30	28–33	Near gale	Sea heaps up and white foam from breaking waves begin to be blown in streaks along the direction of the wind.	4	5.5
8	37	34–40	Gale	Moderately high waves of greater length; the edges of crests begin to break into spindrift. The foam is blown in well marked streaks along the direction of the wind.	5.5	7.5
9	44	41–47	Strong Gale	High waves. Dense streaks of foam along the direction of the wind. Crests begin to topple, tumble and roll over. Spray may affect visibility.	7	10
10	52	48–55	Storm	Very high waves with long overhanging crests. The resulting foam in great patches is blown in dense white streaks along the direction of the wind. The whole surface of the sea takes on a white appearance. Tumbling of the sea becomes heavy and shock-like. Visibility affected.	9	12.5
11	60	56–63	Violent Storm	Exceptionally high waves. (Small and medium sized ships may be for a time lost to view behind the waves.) The sea is completely covered with long white patches of foam lying along the direction of the wind. Everywhere the edges of the waves' crests are blown into froth. Visibility affected.	11.5	16
12	–	64 and over	Hurricane	The air is filled with foam and spray. Sea completely white with driving spray; visibility is seriously affected.	14 or over	–

(*) These columns are added as a guide to show roughly what may be expected in the open sea, remote from land. In enclosed waters, or when near land off-shore wind, wave heights will be smaller, and the water steeper.

EMERGENCIES



Emergencies

In any emergency it is important to remain calm. Crew members should know in advance what their specific duties are in an emergency, and carry out those duties in an orderly fashion.

Firefighting Tactics

The best method for putting out a fire depends on the kind of fire it is. For example, some types of fire extinguishers are effective against fires in wood or paper, but not effective against electrical fires. All crew members should be familiar with the types of fire extinguishers on the vessel, and how the extinguishers should be used.

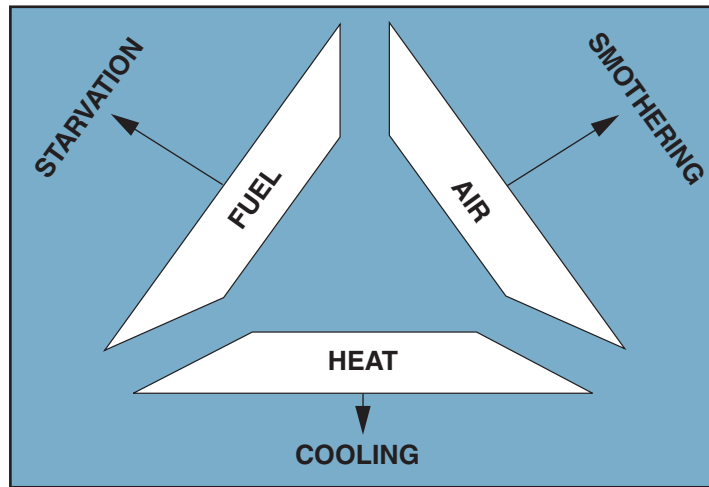

In general, a fire will keep burning as long as there is *heat*, *air* and a source of *fuel*. To put out a fire you have to take away one of these elements.

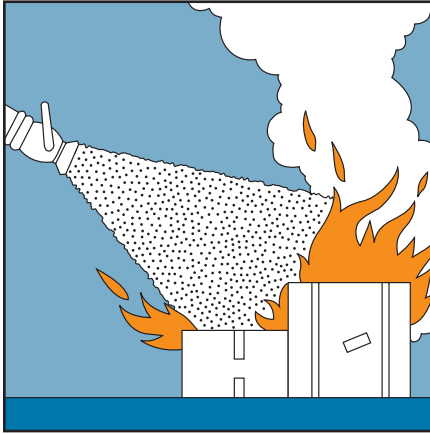

You can “take away” the heat by cooling the fire with water.

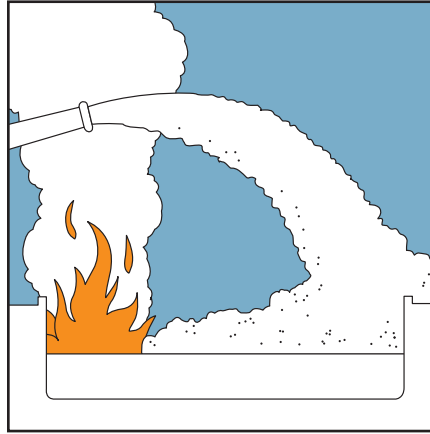

You can take away the air by smothering the fire with foam.

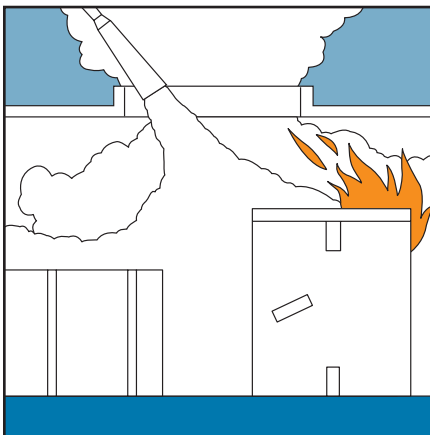

You can also take away the air by spraying the fire with carbon dioxide, which removes oxygen.

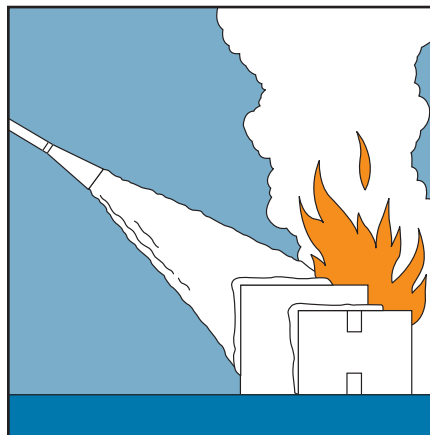

Spraying the fire with a dry chemical will break the chain reaction that causes a fire to spread – one way of “taking away” the fire from the fuel.

Recovering Someone Who Falls Overboard

If someone falls overboard, immediately:

- sound the alarm, turn bow in the direction of the person overboard, stop engines, throw a buoyant object to assist the person and mark the position.
- assign one person to constantly keep the person in the water in sight.
- manoeuvre the vessel carefully to pick the person up.
- be careful when pulling the person in – many would-be rescuers have been dragged into the water by the person in distress.

In addition to the *Lifesling* method of recovery, there are two other methods for rescuing a person from the water. The *Anderson* or *One Turn* method is the fastest, but it requires a very skilful skipper and a vessel with a tight turning circle. The *Williamson Turn* is slower but easier. The Williamson Turn is recommended if there is danger of losing sight of the person in the water.

Lifesling

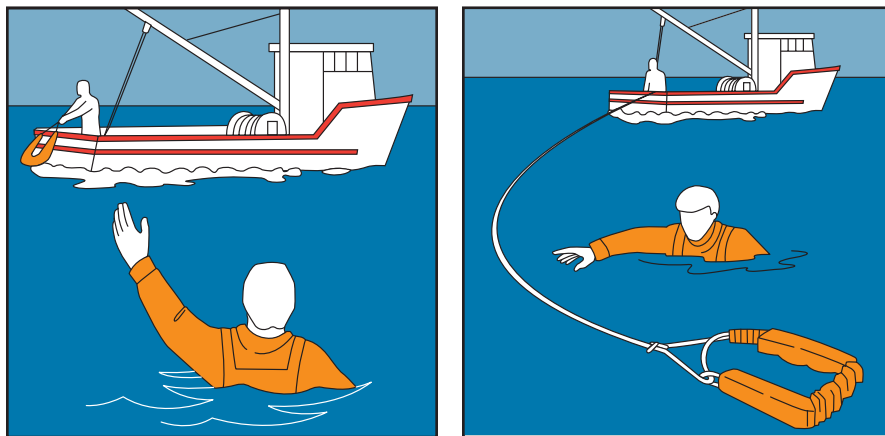

**Lifesling
(continued)**

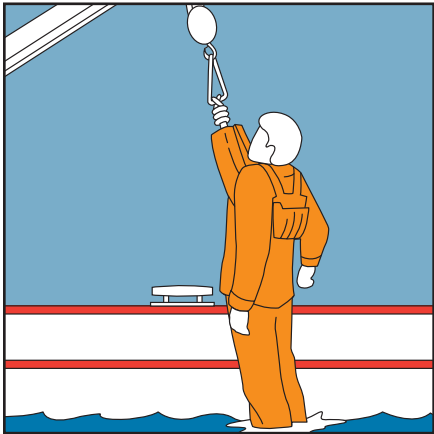
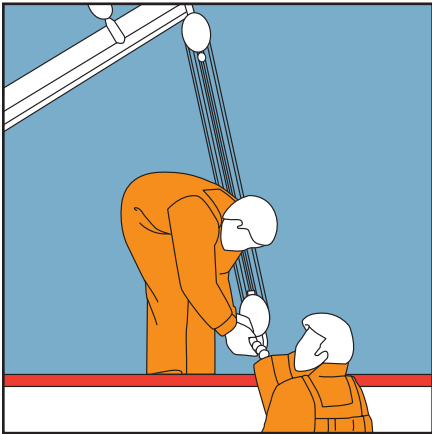
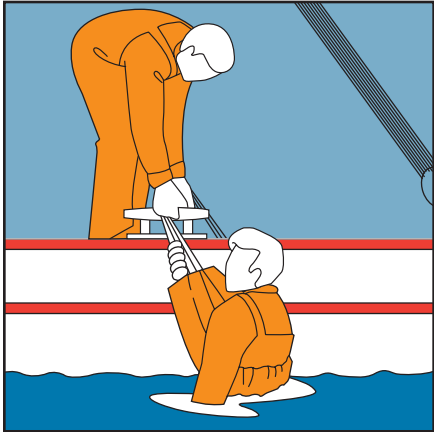
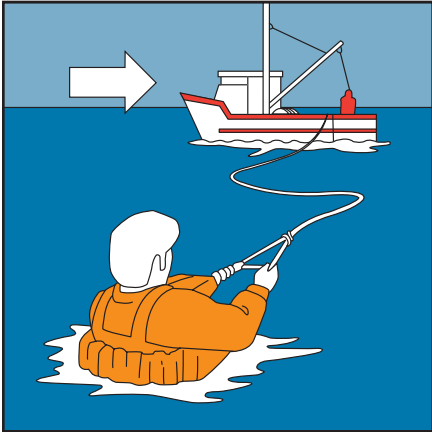

**Recovering
Someone
Who Falls
Overboard
(continued)**

The Anderson Turn

- 1) Put the rudder over full in the same direction as the person (e.g., if the person fell over the starboard side, put the rudder over full to starboard). Stop the engine.
- 2) When clear of the person, go ahead full using full rudder.
- 3) When about 2/3 of the way around, back the engine 2/3 or full. Stop the engine when the person is 15 degrees off the bow. Ease the rudder and back the engine as required.
- 4) Bring the vessel upwind of the person, stop the vessel in the water with the person along-side, well forward of the propellers.

(Many variations of this method are possible, to suit the characteristics of the vessel and sea conditions. Practice runs before an emergency occurs are recommended.)

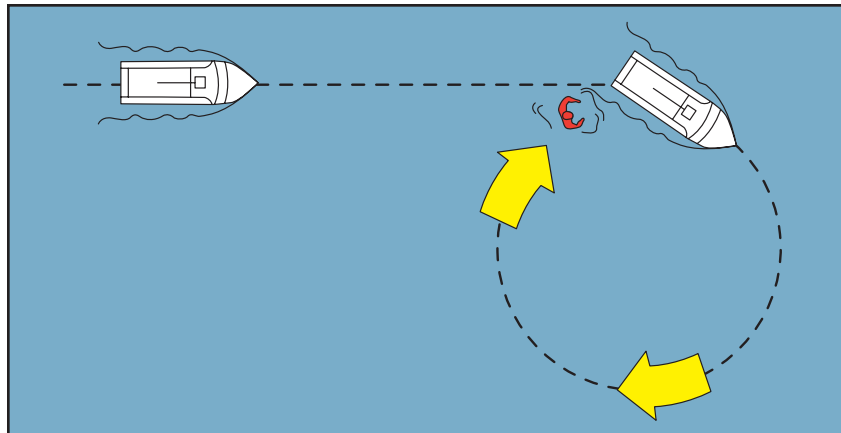

The Williamson Turn

- 1) Put the rudder over full in the same direction as the person (as with the Anderson Turn, #1).
- 2) When clear of the person, go ahead full using full rudder.
- 3) When the heading is about 60 degrees beyond the original course, immediately shift the rudder to full over in the opposite direction. (60 degrees is correct for many vessels, but the exact amount must be determined through trial and error.)
- 4) Continue the turn until the boat is heading 180° from the original course (for example, if the old heading was 90°, the new heading will be 270°) after the turn.
- 5) Bring the vessel upwind of the person, stop the vessel in the water with the person along-side, well forward of the propellers.

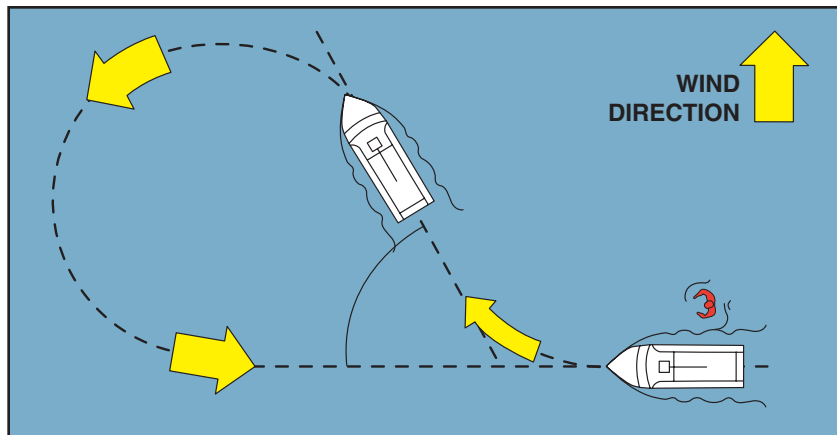

Hypothermia Hypothermia – the loss of body heat – is the greatest danger for anyone in the water. As the body loses its heat, body functions slow down. This can quickly lead to death.

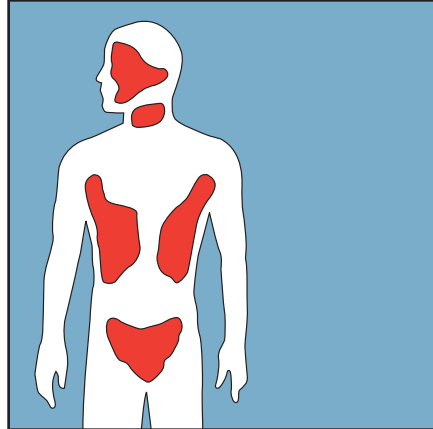

There are three critical areas where the body loses heat most quickly: the head and neck, the sides of the chest, and the groin region.

HELP



The Heat Escape Lessening Position – protects the critical body areas and slows down the loss of heat. Get into this position if you are alone in the water.

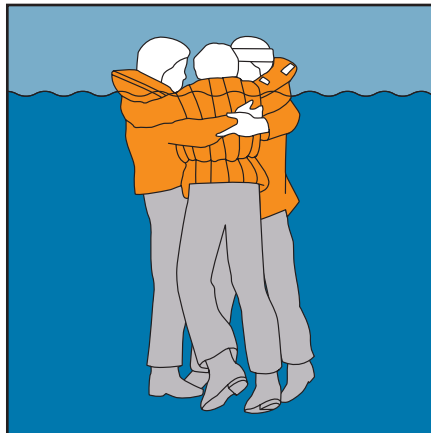

If two or more people are in the water together, form a huddle so that the sides of your bodies are close together.

Treating Hypothermia Victims

Handle hypothermia victims gently, avoiding jolts that could damage the heart.

- Get the victim out of the water to a dry, sheltered place.
- Remove wet clothing *only* if dry clothing is available or if the environment is warm.
- Prevent further heat loss by covering the head and neck. Wrap the victim in blankets.
- Do not rub the surface of the body.
- Use Rescue Breathing if the casualty's breathing has stopped.
- Do not lift the casualty by arms or legs. Elevating the limbs could cause a heart attack.
- Apply heat (40 degrees Celsius) slowly and gently to increase the victim's body temperature. Use things like warm towels, water bottles, or hand warmers applied to the head, neck and trunk. ***Be careful to avoid burns.***
- In severe cases, rescuers could remove their upper clothing and huddle with the victim in blankets or a sleeping bag.
- Give warm drinks such as coffee, tea or cocoa – not alcohol – ***only if the victim is conscious and alert.***
- The condition is *critical* if the victim is getting stiff, is unconscious, or is showing signs of clouded consciousness such as slurred speech – even though the victim may not be shivering. Get medical assistance immediately.

Radio Distress Calls

The Canadian Coast Guard provides 24-hour monitoring on VHF Channel 16 (156.8 MHz) and on MF 2182 kHz. These channels are used for **DISTRESS AND CALLING ONLY**.

In a life-threatening distress situation, select VHF Channel 16 or MF 2182 kHz. Repeat “MAYDAY” three times, then state:

- the name of your vessel
- your position
- the nature of your distress
- your radio call sign
- the number of persons on board
- the assistance you need.
- If equipped with DSC equipment, you should precede the “MAYDAY” call with a DSC distress alert
- Activate your 406 MHz EPIRB

Listen for a response, and repeat the message until you receive an answer.

If there is no immediate danger to life or property, repeat “PAN PAN” three times instead of “Mayday.” Information on marine radio procedure is available from Transport Canada or the Canadian Coast Guard.

Search and Rescue Signals

You should be prepared to respond to the distress signals of other vessels. A Search and Rescue aircraft may also ask you to provide assistance after it has located a vessel in distress.

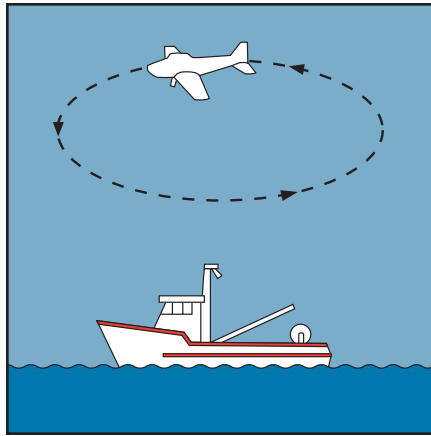

The aircraft will first try to get your attention by circling your vessel at least once.

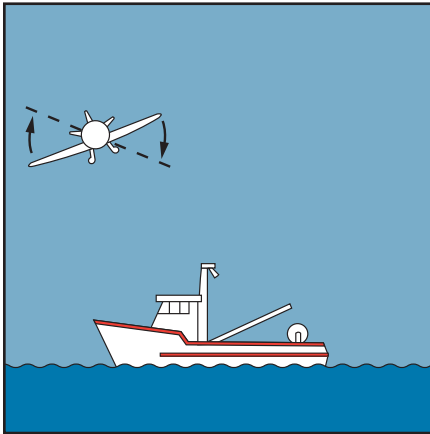

The aircraft will then fly across your course directly ahead of the vessel at low altitude, rocking its wings or opening and closing its throttle. This is the signal that it wants you to follow.

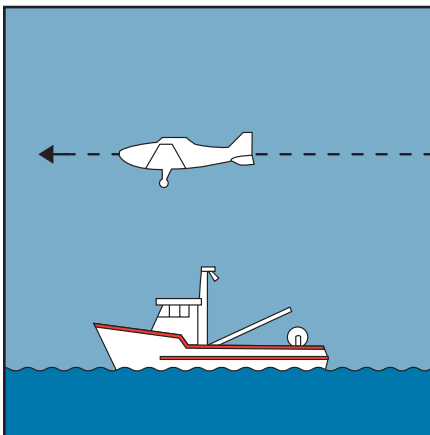

The aircraft will then fly off in the direction it wants you to follow. Proceed in that direction as quickly as possible.

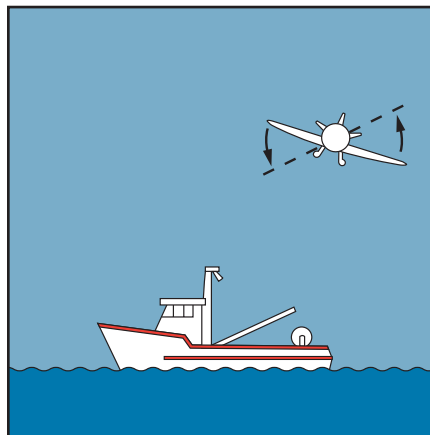

If the aircraft finds that your assistance is no longer needed, it will return and cross your wake close astern at low altitude, rocking its wings or opening and closing its throttle. You may return to your original course.

Standard Marine Distress Signals

Search and Rescue/Canadian Coast Guard

Radio

Radiotelephone
 Call: "Mayday!"
 Give: name and position
 Use: 156.8 MHz-Ch16
 2182 kHz;
 or use alarm signal.
 VHF-DSC

406 MHz
 Emergency position
 indicating radiobeacon
 EPIRB

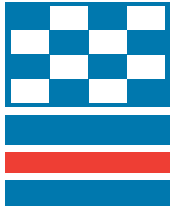

Code Flags

N
 over
 C

Distress Cloth



Ball

over or
 under

Square

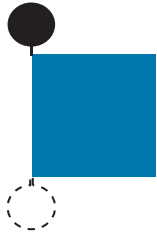

Sound Signals

Continuous:
 Foghorn, bell,
 whistle.
 1-minute intervals:
 Gun or any
 explosive



Flares

Type A:
 Parachute
 rocket



Type B:
 Multi-star
 rocket



Type C:
 Hand-held



Type D:
 Buoyant or
 hand-held
 orange smoke

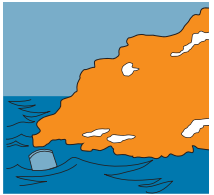

Flashlight



Arm Signal

Do not use near
 helicopter
 (different meaning)

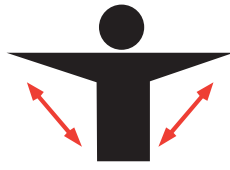

Flame on Vessel

as from burning tar,
 oil in barrel, etc.



Dye Marker

