



Maritime Engineering Journal

CNTHA News

CANDIB TO CONDUCT ORAL
HISTORY INTERVIEWS

CANADA'S NAVAL TECHNICAL FORUM

Summer 2004

Canadian Naval R&D:

Engineering Challenges in the Towed
Integrated Active-Passive Sonar Project

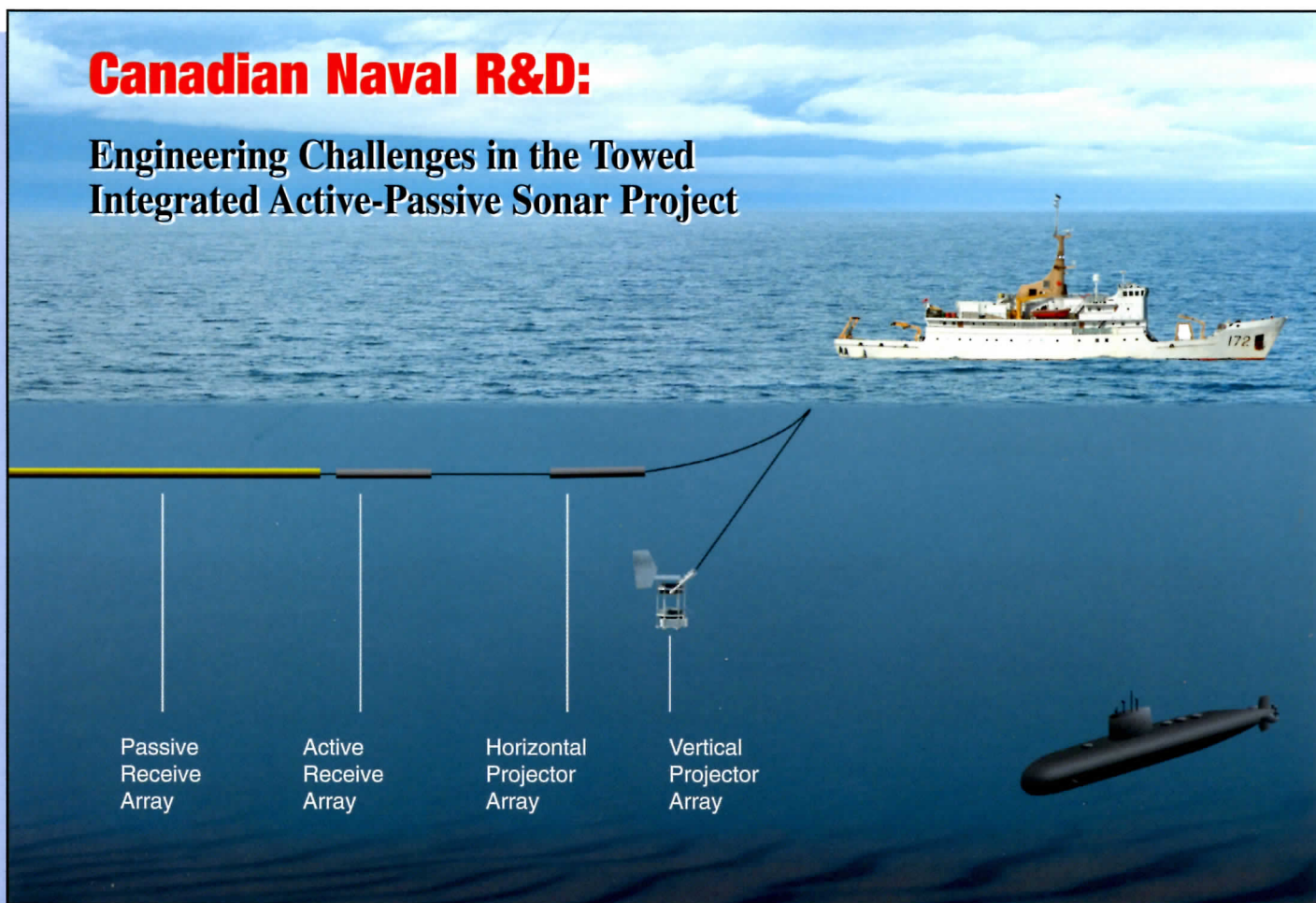

Also in this Issue:

- **MASIS Navy Implementation “Goes Live”**
- *Sixty Years Later:*
Remembering HMCS Athabaskan’s Sacrifice
- **2003 Naval Technical Officer Awards**

Ship Motion Simulation —

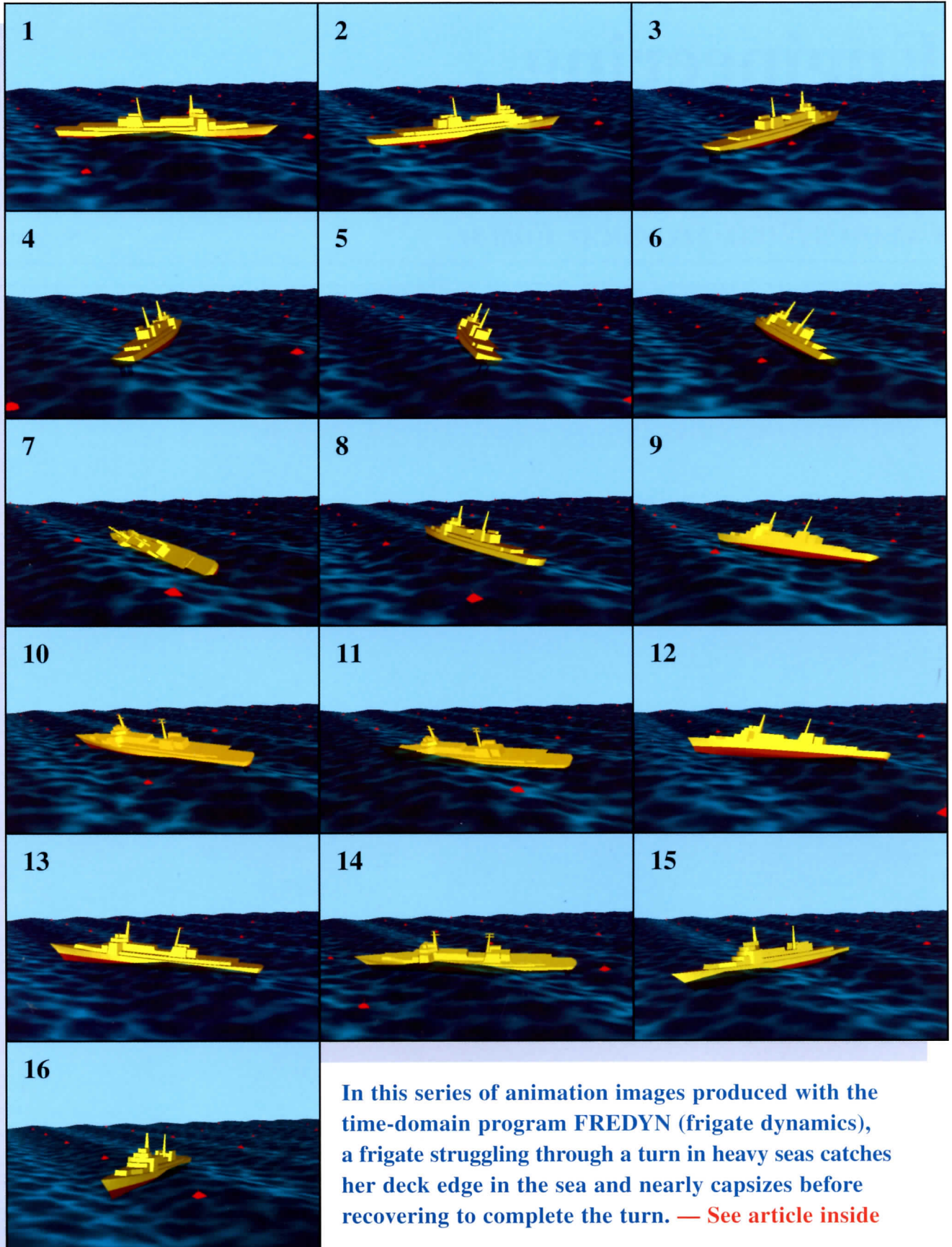

In this series of animation images produced with the time-domain program FREDYN (frigate dynamics), a frigate struggling through a turn in heavy seas catches her deck edge in the sea and nearly capsizes before recovering to complete the turn. — See [article inside](#)



Maritime Engineering Journal

SUMMER 2004

Vol. 23, No. 1 (Established 1982)



Director General
Maritime Equipment Program Management
Commodore Roger Westwood, CD

Editor
Captain(N) Peter Hoes, CD
Director of Maritime Ship Support (DMSS)

Editorial Adviser
Cdr S.R. Richardson-Prager
DGMEPM Chief of Staff

Production Editor / Enquiries
Brian McCullough
Tel. (819) 997-9355 / Fax (819) 994-8709

Editorial Committee Advisers
LCdr Patrick Deschênes (Marine Systems)
LCdr Dave Monahan (Combat Systems)
Jean-François Gagné (Civilian Member)
CPOI Dave Gordanier (NCM Member)

Production Editing Services by
Brightstar Communications,
Kanata, Ontario

Print Management Services by
Director General Public Affairs – Creative
Services

Translation Services by
Public Works and Government Services
Translation Bureau
Mme. Josette Pelletier, Director

ADM(Mat) Translation Co-ordinator
M. Clément Lachance

The Journal is available on the DGMEPM website located on the DND DIN intranet at <http://admmat.dwan.dnd.ca/dgmepm/dgmepm/publications>

DEPARTMENTS

Guest Commentary:
Exciting Times to be in the Defence and Security Business
by RAdm Ian Mack 2

Branch Adviser:
Sixty Years Later: The memory of HMCS Athabaskan's sacrifice is an inspiration to us all
by Capt(N) Pat Finn 5

Forum:
Letter to the Editor
by Capt(N) (ret.) John Mason 6

FEATURES

Research & Development:
Engineering Challenges in the Towed Integrated Active-Passive Sonar Project
by LCdr Mario Boutin 8

Ship Motion Simulation:
Manoeuvring and Controllability in Heavy Seas
by Michael Dervin 12

MASIS Navy Implementation "Goes Live"
by LCdr Wade Knorr 17

Greenspace: Project Update
The Big Picture on Oil Pollution Abatement
by Dan Vachon 20

2003 Naval Technical Officer Awards
by Lt(N) Ryan Kennedy 23

Book Review: Operation Apollo — The Golden Age of the Canadian Navy in the War Against Terrorism
reviewed by Bridget Madill 25

NEWS BRIEFS 26

CNTHA NEWS

Newsletter of the Canadian Naval Technical
History Association *Insert*

Cover Photo: TIAPS — the Towed Integrated Active-Passive Sonar system developed by Defence Research & Development Canada Atlantic represents a major step forward in towed array technology. Story begins on page 8. (Image courtesy DRDC Atlantic)

The *Maritime Engineering Journal* (ISSN 0713-0058) is an unofficial publication of the Maritime Engineers of the Canadian Forces, produced three times a year by the Director General Maritime Equipment Program Management. Views expressed are those of the writers and do not necessarily reflect official opinion or policy. Mail can be sent to: **The Editor, Maritime Engineering Journal, DMSS (6 LSTL), NDHQ, 101 Colonel By Drive, Ottawa, Ontario Canada K1A 0K2.** The editor reserves the right to reject or edit any editorial material. While every effort is made to return artwork and photos in good condition, the *Journal* assumes no responsibility for this. Unless otherwise stated, *Journal* articles may be reprinted with proper credit. A courtesy copy of the reprinted article would be appreciated.

Guest Commentary:

Exciting times to be in the defence and security business

RAdm Ian Mack, Commander of the Canadian Defence Liaison Staff in Washington, D.C., was the guest speaker for the 2004 NTO Mess Dinner held at the CFB Shearwater Officers Mess on April 29, 2004. This is an abridged and edited text of his remarks.

Let me start by saying how thrilled I am to be here among Naval Technical Officers and Executive Officers — and at a traditional mess dinner, something I have missed since leaving Canada for Washington.

I have been out of the maritime engineering business now for 15 years, but as I listened today and chatted with a few of you I was struck by how some things have remained the same — the cyclical review of marine systems training repatriation from the U.K., the backlog of critical preventive maintenance, the palpable excitement of a new shipbuilding program like the joint support ship, and concern for our ability to cope. Other things, however, are very different.

So what to say to such a group?

I am tempted to take you all into the strategic political/military world I live in today — a world of missile defence discussions, of whether to “marinize” NORAD, of how we engage in the Proliferation Security Initiative and the NATO Reaction Force. My domain is focused on influencing the U.S. as they address Afghanistan and Haiti, and on how the current Canadian government affects our bilateral security and defence relationship with the United States. I could regale you with insider stories, but I am reminded of the truism of a not-so-well-known wise man, the Dutch legal scholar Hugo Grotius (1583-1645), who said: “Not to know certain things is a great part of wisdom.” In terms of the intricacies and machinations of

the most complex bilateral relationship Canada has with any nation, it may be better to leave you all “wise.”

Instead, let me say a few words on naval matters. All of you know that we enjoy outstanding interoperability with the USN, having the ability to almost seamlessly integrate with their carrier battle groups. We hold a level of trust that was apparent during Operation Enduring Freedom, where, for example, Commodore Girouard served as commander of Task Force 151 when the Iraq campaign was launched — a command role offered to no other nation.

Many would argue that these are indeed golden years for our navy, but we are also aware that funding is tight. As we grapple with the challenges of modernizing the navy, I would hope that you understand the extent of the funding that is still needed domestically to respond to the threat of terrorism in Canada.

South of the border, the U.S. defence budget is approaching \$400B USD, or 3.6 percent of the U.S. gross domestic product (growing by seven percent of the GDP in the coming year). The USN’s share of this is \$120B, with \$31B earmarked for naval capital procurement, and a “mere” \$15B slated for naval R&D (wouldn’t *that* be nice). To be blunt, the U.S. administration sees all things through a defence security lens now, and that means establishing “defence in depth” as the best way of stopping terrorists far from U.S. borders. This is seen to be the job of U.S. military forces as they “export security” all over the world,

planning for the element of surprise by adopting a pre-emptive, offensive deterrence posture. This is fully consistent with the U.S. National Security Strategy which insists that U.S. forces maintain a technological lead over all other nations’ militaries.

Without a doubt the global war on terrorism has caused a turnaround in defence spending from the reductions of the Clinton years, and has accelerated the transformation of U.S. military forces. For example, looking for improvements to fleet readiness, the United States Navy is now moving away from the standard carrier battle group operational cycle of six months’ operations in every 28 months. As this allows only four of the 12 battle groups to be at sea at any one time, the Chief of Naval Operations is calling for a “surge” capability of six or more available carrier battle groups and greater forward presence, which means overcoming the obvious issue of maintenance. The USN has also introduced a Sea Swap program for changing crews close to a theatre of operations instead of having ships make the long trip back and forth. This has now been tested in four ships, and is next being targeted for an entire expeditionary strike force.

Other U.S. military developments are equally transformational. The littoral combat ship is the CNO’s top acquisition priority, with first ship delivery due in 30 months using R&D funding. The \$15B USD program calls for 60 ships capable of 45 knots in a deep-draft configuration, possibly using water-jet propulsion and, perhaps, a multi-hull design.

Built-in modularity should allow 50 percent of lower-deck space to be used to “re-role” these vessels within 24 hours. Crewed by 50-75 people, the littoral combat ship is intended to be heavily reliant on unmanned aerial and underwater vehicles, making full use of off-board sensors and on-board missile batteries in a truly networked sensor/shooter grid.

In the 2012 time frame, the USN will begin introducing its first all-electric warship to replace ships of the DDG-51 *Arleigh Burke*-class. The DD(X) is also targeting a small crew, just half that carried in the DDG-51, and will depend on its all-electric design to support such novelties as electro-magnetic rail gun weapons and lasers.

I also would highlight that U.S. forces recognize that success in the field has much to do with enhanced joint operations as a true force multiplier and with rapid technology insertion. They still have a long way to go, but they are making solid strides in that direction, starting at the concept development and exploration level in Joint Forces Command, and working right across the R&D world. Such changes, and many more to come, will challenge you in the years ahead as the government directs the Canadian Forces to keep up with the U.S.

Dramatic changes on the horizon will demand an innovative response from us — true thinking outside the box, leaps of logic, even, all carry-

ing significant risks. Ideas we have discarded in the past as “off the wall” may need a fresh and rigorous look. At the risk of provoking dismay, let me challenge you with seven questions:

1. How can we modify our fleet to address both domestic and expeditionary demands in a few years, not a decade?

2. Is the right answer to insufficient maintenance resources inside the FMFs and industry to reduce the number of warships we have at sea, yet retain our current number of sailors so that we can assign one-and-a-half to two crews per ship (ostensibly, a form of “Sea Swap” in home

(Cont'd next page)

Mess Dinner Naval Technical Officer Awards



Journal photo by Brian McCullough

The Naval Technical Officer Awards are presented annually to recognize the achievements of our best junior Naval Technical Officers in their pursuit of leadership and engineering excellence. The 2003 NTO Awards were presented at the Annual Eastern Region Naval Technical Officer Mess Dinner on April 29.

Participants and honourees at the awards presentation included (left to right) RAdm Ian Mack, NCdt Daniel Wilmott (Naval Officers Association of Canada Award), Lt(N) William Wensel (Mexican Navy Award), SLt Lenny MacArthur (CAE Award), Lt(N) Tim Gibel (Lockheed Martin Canada Award), RAdm Glenn Davidson, Cmdre Roger Westwood, SLt Anthea Chang (Northrop Grumman Award), Lt(N) Tom Sheehan (Peacock Award), and Lt(N) Denis Pellichero (MacDonald Dettwiler Award). *(See also pages 23-24)*

port), or to insist upon prefacilitated contracts with Halifax Shipyard Ltd. to keep up with the technical support workload?

3. Should we “marinize” NORAD by posting many more sailors there and by placing ships on four hours’ notice under this “Son of NORAD” scenario?

4. Can we put Standard III missiles in our ships as Canada’s contribution to missile defence participation, with the realization that such ships will occasionally draw picket duty in the Middle East or off North Korea for months on end?

5. Are we prepared to turn Halifax, Greenwood and Land Force Atlantic Area into a joint command, operating and exercising daily under a joint forces construct to fully capitalize on the joint support ship once delivered?

6. Are we ready to accept that international development projects such as the Evolved Sea Sparrow Missile are unlikely to work in the future as the U.S. becomes more unilateral in its efforts to stay well ahead of all other navies?

7. Should we rely on Naval Technical Officers at sea to provide all deployed maintenance support to the new maritime helicopters when they enter service?

I raise these questions more to tease and demonstrate, rather than to recommend any of these courses of action. In fact, I would emphasize that I am not advocating for any of them. But I also encourage you to tackle such strange and unconventional “way out” ideas, and not be deterred by your desire for a 100% solution. As a Buddhist monk said so long ago: “If you shut the door to all errors, truth will be shut out.” We are in the business of risk management, and we must embrace it.

As I sum up, I wish to leave you with two messages. The first is that these are exciting times to be in the security and defence business. The launch of the Joint Support Ship Project and the Frigate Life Exten-

Grace for the Mess Dinner

Written and offered by Padre Lt(N) Joseph F. Johns,
Chaplain, Canadian Forces Naval Engineering School

**God of stars, wind,
and blue waters of ocean and sea**

**watch over these graduates
who will soon embark on their OJTs**

**May they lead by example as officers
And be proficient technical managers**

**May logical approach and structural design
Be imbedded in their business case analysis minds**

**Send them calm days and many peaceful nights
and help them remember that starboard is to their right**

**Always point their bows at whatever they are seeking
And keep their feet dry if their ship starts leaking.**

**Lord, give them fair weather and sunsets of pink
and please don’t let their vessels sink.**

**God bless this wine and meat dressed with gravy
but above all, bless these men and women of the Canadian Navy.**

Amen

sion Project, and times that are not soon going to become stable security-wise — these guarantee that you will all have challenging and rewarding careers ahead.

My second message is to highlight the respect we enjoy as Canadians, as members of the Canadian Forces, and as a navy. I get this from everyone I meet, wherever I go. My duties have me engaged with the U.S., most assuredly, where the contribution of each and every member of our navy over the past two years is known and lauded. But I also work on the Inter-American Defence Board with our colleagues in the Caribbean, Central America and South America, where the level of respect for “things Canadian” is amazingly high in most countries, as are their expectations of us.

I regularly meet sailors of other nations who speak of your professionalism, your common sense, your world view, your compassion and caring. What this tells me, is that it is YOU and your crewmates who are

so highly respected — not your equipment. You should be very proud of what you do and of what you have accomplished. This gives me great confidence, as it should you, that today’s and tomorrow’s naval leaders will ask the tough questions and take the necessary action to remain on top of our game.

Respect characterizes our international legacy. True transformation to respond to the exciting times ahead — that is our collective challenge. May God grant us the wisdom to meet that challenge.



Branch Adviser Commentary



Sixty Years Later: **The memory of HMCS *Athabaskan's* sacrifice is an inspiration to us all**

By Captain(N) Pat Finn

As Branch Adviser I am typically asked to provide an update on personnel-related issues for the *Journal*. This time, I thought I would stray from the standard approach and offer you a perspective on a recent experience.

I attended a dinner, last May, hosted by the Society of Naval Architects and Marine Engineers. During that evening, LCdr Jocelyn Turgeon gave a presentation on his involvement with the identification of the first HMCS *Athabaskan*, a tribal-class destroyer sunk by enemy fire off the coast of France on April 29, 1944. *Athabaskan* was on patrol with HMCS *Haida* when they engaged two German warships. *Athabaskan* was hit and lay dead in the water, but afloat. Ten minutes later she was rocked by a second explosion, which sank her with the loss of 128 of the 263 men on board.

LCdr Turgeon, the hull structures officer in DMSS 2, was part of the team assembled by Canadian filmmaker Wayne Abbot to visit the wreck of *Athabaskan* during the summer of 2003. Their efforts were recorded in the documentary, "The Mysterious Sinking of HMCS *Athabaskan*," which aired on television on April 29, 2004, the 60th anniversary of *Athabaskan's* sinking. Jocelyn Turgeon was instrumental in confirming that the wreck was in fact the *Unlucky Lady*, as she was known.

I attended the dinner and presentation simply as a naval officer and diver interested in our history. Yet, what I experienced was something far more powerful than I had expected. One reason for the emotional effect was that I was accompanied that evening by my neighbour and friend, Peter Ward, a man who has a strong personal bond with *Athabaskan*. His father, Lt. Leslie Ward, was lost with the ship and was reported as missing, presumed dead



Lt. Leslie Ward

along with 84 other men and "Ginger," the ship's cat. The bond has continued with the generations in the Ward family, and it was Peter's own son Mark, an expedition diver, who placed a commemorative plaque on the wreck on behalf of the Canadian navy.

As I listened to the story and met several other people who had lost loved ones in *Athabaskan*, I felt a reaffirmation of what we do in the

navy. As members of the Canadian Forces we have a tendency to downplay our efforts. We may be engineers and technicians, but we are first and foremost sailors serving our country. Although, there are days when battling bureaucracy makes it difficult to maintain this understanding. The people I met that evening were extremely proud of their military — proud of the men who were lost in *Athabaskan*, and equally proud of what you are doing to serve Canada today. Whenever I have a bad day at the office, I remember the sacrifice of those Canadian sailors who gave their lives in *Athabaskan* and in other Canadian ships, and I remember that I must do my best to honour their sacrifice. It is a very humbling feeling.

As Branch Adviser, I get to see the hard work and dedication of the people in our branch first hand. The interaction is very motivating to me, especially as the incredible commitment I witness in all of you seems not so very different from the spirit of duty and sacrifice that the sailors of HMCS *Athabaskan* showed so bravely to the rest of the world sixty years ago. May their example continue to inspire those of us who choose the navy for our career.



Forum

On reviewing the Summer 2003 issue of the *Maritime Engineering Journal*, two articles caught my attention with relation to my personal experience.

I know and respect Alan Wyatt, who is a fellow member of the Naval Officers Association of Vancouver Island (NOAVI). With regard to Alan's letter, some time after the RN's creation of the General List officer structure, the same idea was adopted by the RCN. Our General List scheme went much farther in that the seagoing command structure was opened up to all officers, regardless of former branch connections. I was one of the first engineer officers to follow this option.

The first step was to obtain a bridge watchkeeping certificate, which I undertook in HMCS *Chaudiere* in 1959. Instead of the usual granting of this certificate by the commanding officer after six months, I was a test case and underwent an examination in another ship headed by a Cdr (Navigation) and a LCdr (Navigation Direction). I passed to their satisfaction and went on to become senior watchkeeper in *Chaudiere*. I was fortunate in that the engineering duties were largely undertaken by a Sub-Lt (E) who had a masters degree in engineering (and went on to become a professor at RMC).

Over the next several years I took brief courses ashore and passed all of the written command examina-

tions in gunnery, celestial navigation, action information, underwater warfare, supply, and so on. Of course, I did not have to write engineering. The final hurdle was a command board in 1962, headed by the commanding officer of HMCS *Bonaventure*, Captain "Scruffy" O'Brien, and three commanders. As I rambled on about a "What would you do if?" situation, my board ended abruptly with, "Okay, Mason, that's enough." I thought I had flunked, but after they debated my fate I was called in and, to my delight and surprise was congratulated on becoming the first engineer to qualify for command.

Unfortunately, command did not immediately follow. I learned later that I had been the subject of much argument at senior levels, and was instead sent off to a shore job in the rank of commander. Then to my delight, on July 18, 1964, I was appointed in command of HMCS *Algonquin*. LCdr J.Y. Clark was appointed in command of HMCS *Athabaskan* a month later, and thus two ships out of five in the Fifth Destroyer Squadron were commanded by engineers.

My next appointment was as the executive officer of the naval barracks at HMCS *Stadacona* in Halifax, making me the first engineer officer to hold this job. Subsequent jobs as Senior Maritime Liaison Officer at CDLS, London, and Defence Attaché in Norway had never before been held by an engineer officer.

Several former engineers went on to flag rank, including Chuck Thomas and Jock Allen. But what happened to our General List scheme?

* * * * *

I noted in the CNTHA newsletter insert about the Naval Technical Apprentice Training Plan that, "It has been more than 50 years since the first entry of naval technical apprentices enrolled in the Royal Canadian Navy." This is true if one goes back to 1941.

In late 1941 the wartime Engine Room Artificer (ERA) Apprentice Program began in Galt (now Cambridge), Ontario. Before the end of WW II, nine divisions of about 45 men each were trained in Galt, and later three in Calgary and one in Windsor. We joined as stokers 2nd class. The first three divisions were enlisted into the RCN, while those who followed were enlisted in the RCNVR. I was a member of Division #7 in Galt, which began training in February 1943. We were trained in machine and fitting shop practice, welding, electricity, mathematics and marine engineering. We were billeted in private homes and, except for compulsory divisions and church parade every Saturday morning, we had the weekends off. We had a rude awakening when we arrived in Halifax just before Christmas, 1943, and were billeted in old "A" block where the snow sifted in through the windows and the toilets froze!

Maritime Engineering Journal Objectives

- To promote professionalism among maritime engineers and technicians.
- To provide an open forum where topics of interest to the maritime engineering community can be presented and dis-

cussed, even if they might be controversial.

- To present practical maritime engineering articles.
- To present historical perspectives on current programs, situations and events.

- To provide announcements of programs concerning maritime engineering personnel.
- To provide personnel news not covered by official publications.

At the Mechanical Training Establishment we underwent further machine shop practice, sheet metal shop, moulding shop and marine engineering. Finally, there were written examinations and a trade test requiring machining and hand-fitting of a strange object called “nut, block, gib and cotter,” for which we were allowed 60 hours. [*Editor’s Note: Captain Mason tells us this object served no purpose other than to test an apprentice’s skill at machining and fitting.*]

We then went off to sea for six months as stokers 1st class to obtain our auxiliary watchkeeping certificates, and do all those good things that stokers do. But what a waste of all that training. Finally, the great

day came when we were awarded our auxiliary watchkeeping certificates and were subsequently promoted to acting ERA 4th class and moved to the ERA’s mess. What a difference — it was like being elevated to the peerage!

I estimate that before war’s end about 600 men had been trained under this program. Without them, the many new ships could not have been manned with adequate numbers of trained engine-room personnel. About 60 stayed in the postwar navy, and most of these became chief ERAs. About a dozen-and-a-half were commissioned.

I was pleased to learn about the Naval Technical Apprentice Pro-

gram, which was certainly longer and more extensive than our urgent and accelerated wartime ERA Apprentice Program. But whatever happened to the NTA Program after 1970?

— **John Mason**
Captain RCN (ret.)

— **former Stoker 2nd Class**

<http://www.islandnet.com/~jwmason/>

click on “about the author” or
“Wartime ERA Apprentices”



Submissions to the *Journal*

The *Journal* welcomes **unclassified** submissions, in English or French. To avoid duplication of effort and to ensure suitability of subject matter, contributors are strongly advised to first contact **The Editor, Maritime Engineering Journal, DMMS, National Defence H.Q., Ottawa, Ont., K1A 0K2, Tel. (819) 997-9355**. Final selection of articles for publication is made by the *Journal*’s editorial committee. Letters of any length are always welcome, but only signed correspondence will be considered for publication.



Call for Papers — 7th MARCOM Conference

Maritime Command, along with the Directorate of History and Heritage, is holding a two-day conference on Canadian naval history at the new Canadian War Museum in Ottawa on Thursday, September 22 and Friday, September 23, 2005.

Papers on all aspects of Canadian naval history are welcome, but special consideration will be given to those that focus on technological

aspects of the navy’s weapons, platforms and tactics during the Cold War period.

Those interested in presenting are required to submit a proposal to the following address by 01 March 2005:

Lieutenant (N) Richard Mayne,
Directorate of History and Heritage,
101 Colonel By Dr. Ottawa, ON,
K1A 0K2. Tel: (613) 998-7048. E-mail: Mayne.RO@forces.gc.ca.

Proposals should not exceed one page in length and must contain the author’s phone number and e-mail so that the reviewing committee can contact them with their decision.



Research & Development:

Engineering Challenges in the Towed Integrated Active-Passive Sonar Project

Article by LCdr Mario Boutin

The Towed Integrated Active-Passive Sonar (TIAPS) Project is a major Canadian defence R&D effort to evaluate the combination of a state-of-the-art passive towed array sonar with a low-frequency active sonar. The project aims to satisfy an operational requirement to improve the navy's ability to detect modern, quiet submarines operating in littoral waters (both deep and shallow) and in the open ocean.

The TIAPS Project was initiated in 1997 at Defence Research & Development Canada Atlantic (DRDC Atlantic) in Dartmouth, Nova Scotia. There, a team of scientists and engineers is investigating the most promising methods for improving the

performance of tactical underwater detection systems. Several scientific development efforts were amalgamated under the project, including a significant scientific effort devoted toward advanced information management designed to present a sonar-based tactical picture to a ship's command team.

As with any other R&D enterprise the TIAPS Project has presented some fascinating engineering challenges, three of the most interesting of which are the subject of this article. The first involves a sensitivity problem with the Multi-Aperture Networked Towed Array (MANTArray), the second deals with an ambiguity resolution sensitivity problem in the Directional Acoustic Sensor Module

(DASM), and the third centres on the challenges of reusable software in the System Test Bed processing subsystem.

Challenge 1: Multi-Aperture Networked Towed Array Sensitivity Problem

The MANTArray, the passive receive array of TIAPS (Figs. 1 and 2), consists of two high-frequency and six medium-frequency acoustic modules, as well as a number of non-acoustic sensor modules and vibration isolation modules. The MANTArray receives power from and sends telemetry data to the ship via the TIAPS tow cable. Raw digital data from the array is transmitted across a redundant pair of multimode optical fibres.

During TIAPS sea trials, significant fluctuations in the order of 10 dB or more were observed in the channel noise levels in data from across the MANTArray. The problem appeared as a slow modulation of the gain evidenced by shifts in the ambient noise level and the energy received from distant tonal targets. It was also noted that there were unusually high side lobes evident from the beam forming process.

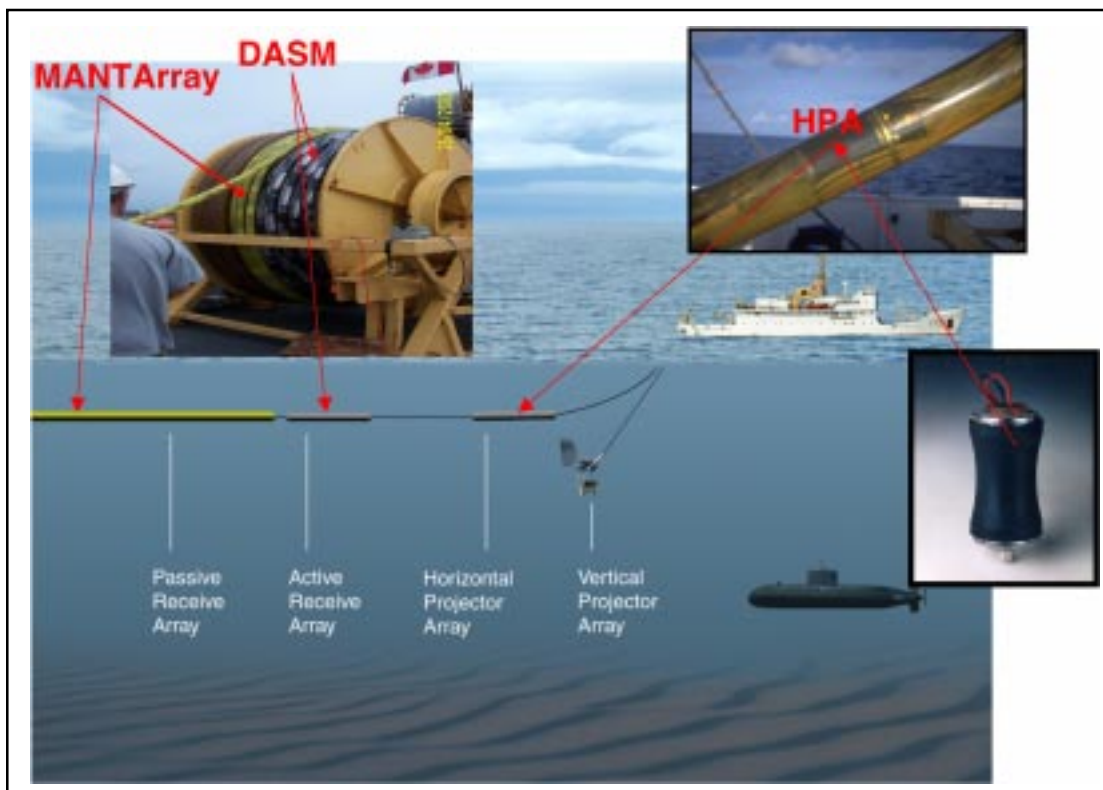

Fig. 1. The Towed Integrated Active-Passive Sonar System

Data from a single channel indicated the presence of a strong infrasonic signal and a harmonic of somewhat lower intensity. The first assumption was that the preamplifiers were being overdriven by the infrasonic signal which can originate from any number of ambient noise sources. These might include ship traffic, seismic activity, subsurface ocean waves, and even “bulge” waves caused by the stretching and compression of the array as it is towed through the water induced by the ship’s movement. In reviewing the problem, however, the following possible avenues were investigated:

- **hydrophone wetting** — Hydrophones in the MANTArray are mounted in foam-filled supports, and there was concern that air might be trapped in the foam, preventing the hydrophones from being properly wetted and thus affecting their sensitivity. An array module was disassembled and the hydrophones were removed and compared with unused spare units. The degassing (air-removal) process was reviewed and applied to some of the spare hydrophones. The physical masses of the hydrophones from the array were compared with the masses of spares in their supports and with those of other units subjected to a revised degassing process, but the differences were negligible. A subset of hydrophones and pre-amplifiers was tested at the calibration barge to determine if there were any variations in sensitivity due to directional effects, but none was found. It was concluded that the degassing process is sufficient to ensure the hydrophones are properly wetted.

- **preamplifier and analogue-to-digital (A/D) stability** — The

preamplifier, A/D converter and power supply circuits were reviewed to examine the possibility of an electronic source to the time-varying gain. Hydrophones were replaced with electronic signal inject circuitry and the system was run for an extended period. The basic data acquisition circuitry appeared to be stable.

- **power supply stability** — Since a 100-Hz high-pass filter present in the system should help suppress low-frequency signals from the preamplifier output, DRDC Atlantic staff performed a test by driving a high-level, low-frequency signal, and a low-level higher frequency signal into the preamplifier to see if any overloading or clipping occurred. In the course of bench testing the system, it was noted that by squeezing the towed array hose to pressurize a module at low frequencies (under 1 Hz), it was possible to get effects that were similar to those observed in the sea trials data.

Upon review of the experimental set-up it was noted that the application of a Hanning window to the incoming data stream (a procedure for

calculating discrete frequency components from sampled time data) seemed to reduce the level of fluctuation. The Hanning window does not have the amplitude accuracy of a similar flat-top window procedure, but provides better frequency resolution. It was hypothesized that there was some low-to-high-frequency leakage (i.e. harmonic distortion, aliasing) occurring in the signal processing and adding a high-pass filter to the pre-amplifier would likely reduce this leakage.

- **signal processing algorithms** — The signal processing chain was reviewed and scrutinized. It was noted that while the addition of a Hanning window reduced the amount of infrasonic contamination of the data, the windowing produced infrasonic artifacts of its own which would likely affect the data processing. Tests were done using simulated signals to attempt to replicate the problem, while computer modeling of the hydrophone/preamplifier circuit was done in parallel. The result of the testing determined that a single-pole high-pass filter was insufficient to suppress the infrasonic sig-

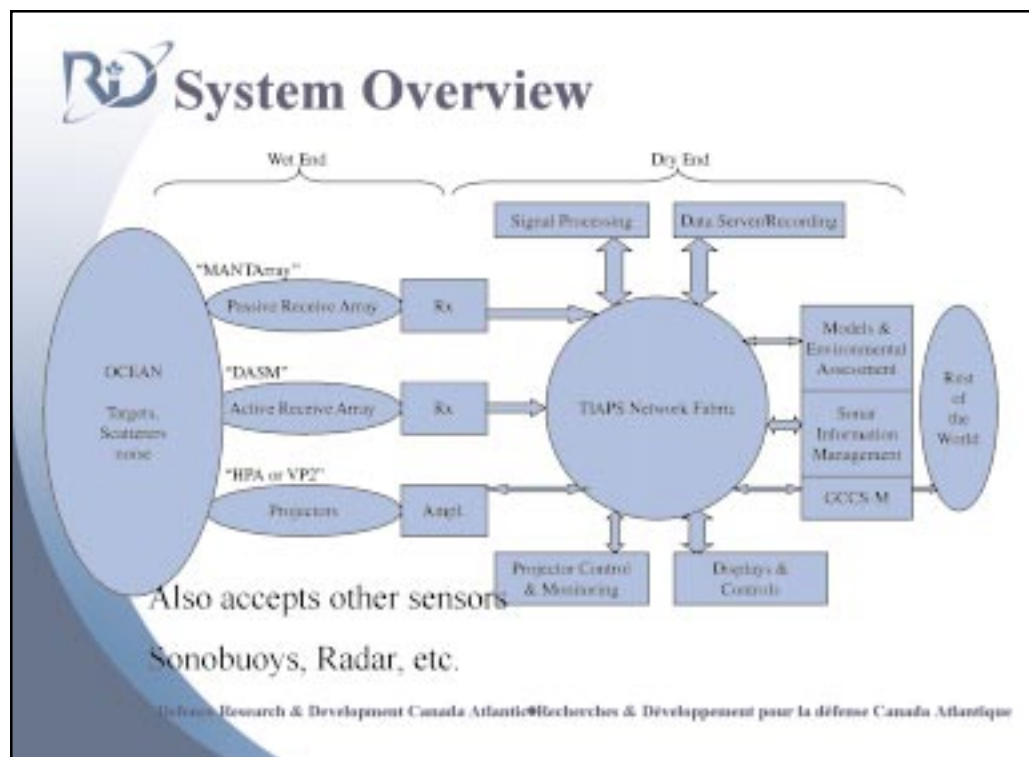

Fig. 2. TIAPS System Overview

nal. It was noted that past arrays had additional high-pass filters at 10 Hz and 1 Hz. Filters have been added to one of the high-frequency modules and additional testing will be done during the next sea trial to determine if adding these filters solves the problem.

**Challenge 2:
Directional Acoustic Sensor
Module Ambiguity Resolution
Sensitivity Problem**

A second challenge occurred with the DASM (the active receive array of TIAPS), which is comprised of 96 combined omni-resolved dipole sensor (CORDS) units. CORDS sensors (Fig. 3) contain an omni-directional pressure sensor (hydrophone) and a transverse dipole sensor. Transverse dipole sensors are an attractive addition to towed array modules because the dipole signals when combined with signals from omni-directional hydrophones produce cardioid-like directivity patterns which can resolve left/right ambiguity in the towed array sonar without any ship manoeuvring.

The performance of the CORDS units has degraded over time such that their ability to resolve left/right ambiguity has diminished significantly. Investigation has shown that this is largely due to a loss of isopropyl alcohol (IPA) “wetting agent” within the mercury-filled resolvers. The loss of IPA was affecting the resolver’s variable capacitance, which is the critical factor in its operation. Although the wetting agent was replenished, it may only be a temporary solution to the problem because the reason for the loss of the agent is still not known. The lack of consistency in deterioration was also puzzling as it suggested some variation in the factors influencing it. The only things that would vary significantly within the construction of the resolver are the amount of epoxy adhesive that may have been used in

sealing the pin connectors, the epoxy mix ratio, or the amount of O-ring lubricant. All other materials are common.

Another theory suggested that oxygen contamination was causing the capacitance to degrade. When oxygen contamination occurs, increased mercuric oxide is observed on the surface of the mercury and can be seen deposited on the ceramic. It is believed this interferes with the conductive interface between the mercury and the end-cap electrode.

A possible solution lies in the development of a solid state CORDS unit, which uses an accelerometer-based roll resolver. This will enable the units to be built without mercury

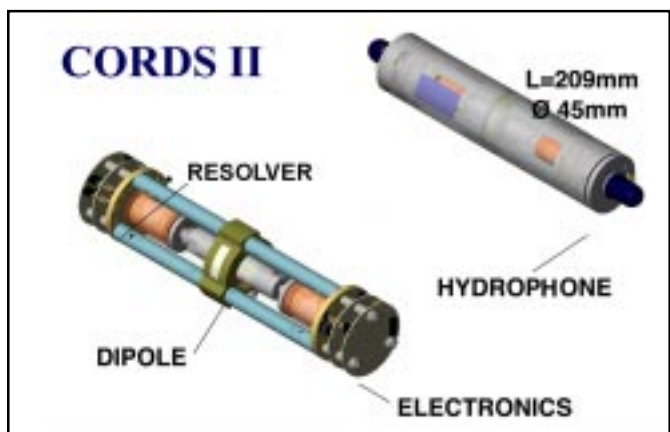

Fig. 3. The TIAPS Directional Acoustic Sensor Module contains 96 combined omni-resolved dipole sensor (CORDS) units as pictured here. The combination of hydrophones and dipole sensors enables resolution of left/right ambiguity in the towed array sonar without any ship manoeuvring.

filled resolvers. Prototype units will be tested at sea this summer.

**Challenge 3:
System Test Bed Subsystem
Reusable Software Issues**

The initial work in developing the System Test Bed (STB) was a continuation of the Next Generation Signal Processing (NGSP) application development based on the Experimental Towed Array Sonar System (ETASS) software used to develop the original prototype system for CANTASS. The STB is the basis of the signal processing and display suite (Fig. 4), which is a collection

of hardware and common object-oriented programming software components that provide active and passive sonar processing and display functionality for sensor, feature, contact, track and environmental data. Written primarily in C++ and Java, the STB was designed to provide flexible, portable, reusable, scalable functionality for a wide variety of sonar applications. The choice of languages allows the specific functionality of an executable file to be determined at run time using dynamic instantiation of the objects involved. In addition, the availability of threads in these languages makes the task of “parallelizing” the processing much easier.

Based on earlier experience, the STB was designed as a collection of reusable functional components using a producer/consumer model. The design also mandated that components only communicate with one another through a common data server. This design provides an additional level of abstraction in which changing the interaction of one component with the data server does not, in general, require changes to other components. Building fully reusable software requires that a number of conditions be met:

- A toolset, which includes such things as class browsers, debuggers, compilers, etc., must be available. The toolset must also be adapted to the development of complex object-oriented software, and be accepted by the potential developers of the system;
- A source code control, or revision control system must be available to allow review of the code as it is added to the system. The revision control system has to fit the development methodologies that were used, and be accepted by potential system developers;



Fig. 4. TIAPS Signal Processing and Display Suite

- A documentation system must be in place to allow new users of a class (of which an object is a specific instance in object-oriented programming) to determine the class's applicability and limitations quickly. The documentation itself must also be under source code control;

- A testing, verification and validation standard must be established and adhered to to allow component testing on both an individual and group basis; and

- A problem reporting system must be available to track bugs or problems with the code and to provide documented feedback on the resolution of problems.

The System Test Bed began development as a tool to implement the Towed Integrated Active Passive Sonar (TIAPS) system. A requirement existed to reuse as much of the software developed for ETASS on the NGSP as possible. A requirement also existed for both rapid prototyping of the system and for maximum flexibility to accommodate changes to the underlying processing as the project proceeded. In its current state of development the STB system has demonstrated successful reuse. It does not, however, have all elements in place. Future growth and reuse will depend on

developing and introducing additional components into the code base.

The next challenge will be to deploy this technology in a naval platform. To that end there are initiatives to take STB-based sonar signal processing and display systems such as TIAPS and SHARPSHIN to sea for advanced experimentation in a naval platform. TIAPS and SHARPSHIN are DRDC projects that resulted in, among other things, the development of sonar signal processing and display tools in a common object-oriented, network-enabled environment running on collections of commercial off-the-shelf processors. SHARPSHIN initially was programmed to process and display AN/SQS-510 data, and was designed to investigate improved processing and display of this data for mine avoidance and torpedo detection. The system has been used to develop a number of improved processing and display algorithms, including a high update rate passive display for detailed analysis of transients, a bearing sector-time-range intensity display (the z-scan) for both FM and CW operations, and a broadband display option allowing selection of upper and lower bands together, or separately, to enhance the tracking of

active contacts. SHARPSHIN also features improved beamforming for better side-lobe reduction.

The TIAPS technology has been demonstrated in the research vessel CFAV *QUEST* using both the AN/SQR-19 array and two new, high-dynamic-range digital towed arrays (MANTArray and DASM) and a processing and display suite using the STB. A TIAPS partial operational demonstration with a subsurface target has already been conducted.

By nature, research and development activities provide for significant technical challenges which are frequent and often require technology to catch up before a solution can be implemented. As a Naval Combat Systems Engineer, my experience at DRDC, both as a project manager and as a program management group leader, has been very interesting, challenging and rewarding.

Acknowledgement

Thanks to David Hazen, Gavin Hemphill, John Bottomley, Art Collier, Rob Campbell, Lyle Bristo and Bob Trider for their input to this article.



LCdr Boutin is a Naval Combat Systems Engineer, and the TIAPS Project Manager at the Defence Research & Development Canada (Atlantic) agency in Dartmouth, Nova Scotia.

Ship Motion Simulation:

Manoeuvring and Controllability in Heavy Seas

Article by Michael Dervin

The ability to manoeuvre a ship safely and control its heading in a variety of environmental conditions is a fundamental requirement. While even the most basic manoeuvres can be challenging at slow speed in relatively calm conditions, simply maintaining heading in severe weather can be difficult. Turning a ship in the most severe conditions can be impossible, and can result in capsizing the ship in the attempt. Slow-speed harbour controllability, particularly in windy conditions, presents a high risk of collision and thus damage, but tug assistance is usually available to large ships during tricky in-harbour manoeuvring situations. Not so for ships in littoral waters or on the open ocean where, given severe enough conditions and inappropriate manoeuvring actions, capsize is possible. Ironically, there is little guidance available for ship manoeuvring and control in heavy seas. On-board guidance is typically limited to turning circle data for calm water, no-wind conditions as illustrated in Fig. 1. Unfortunately, such ideal conditions rarely exist at sea.

Guidance on heavy weather shiphandling can be found in such books as the *Admiralty Manual of Navigation*, *Admiralty Manual of Seamanship*, P.F. Willerton's *Basic Shiphandling for Masters, Mates and Pilots*, and the 1955 classic, *Naval Shiphandling*, by Cdr (USN) J.S. Crenshaw Jr. — all good references, drawing upon the experience of years of operating ships at sea. However, such guidance is generic and does not link the capability of a given ship to a specific seaway for various manoeuvres. Through advances in computer simulation we now have

the ability to model a ship manoeuvring in any sea condition. Application of this technology was described in "A Dynamic Approach to Assessing Ship Stability," (Michael F. Dervin and Dr. Kevin A. McTaggart, *Maritime Engineering Journal*, February 1997), although manoeuvring was not addressed.

In 1999 the NATO Naval Armament Group gave its approval for a specialist team to study naval ship manoeuvrability. The overall objective was to develop a common understanding of naval ship manoeuvrability criteria. A two-volume Allied Naval Engineering Publication (ANEP-70) was subsequently produced to offer guidance on naval ship manoeuvring.¹ As part of Canada's contribution to this NATO work, Mr. Dervin drafted the section on "Manoeuvring and Controllability in Heavy Seas," making use of FREDYN, a time-domain computer program able to simulate a ship ma-

noevring in severe wave and wind conditions.

The current state-of-the-art in computer simulation is to use such time-domain analysis tools. This technique continuously recalculates all parameters of the simulation for each moment in time as the simulation progresses. However, for assessing ship-manoeuvring performance in heavy seas, such programs are for the most part unvalidated. Part of the problem is the lack of validation data for ships attempting to execute various manoeuvres in extreme conditions. Physical model test data is scarce and real-world experiences are mostly anecdotal. Furthermore, because of the highly non-linear nature of ship responses in such an environment and the randomness of the sea itself, hundreds and perhaps thousands of simulations become necessary to generate a statistically significant data set that can adequately identify trends. Any con-

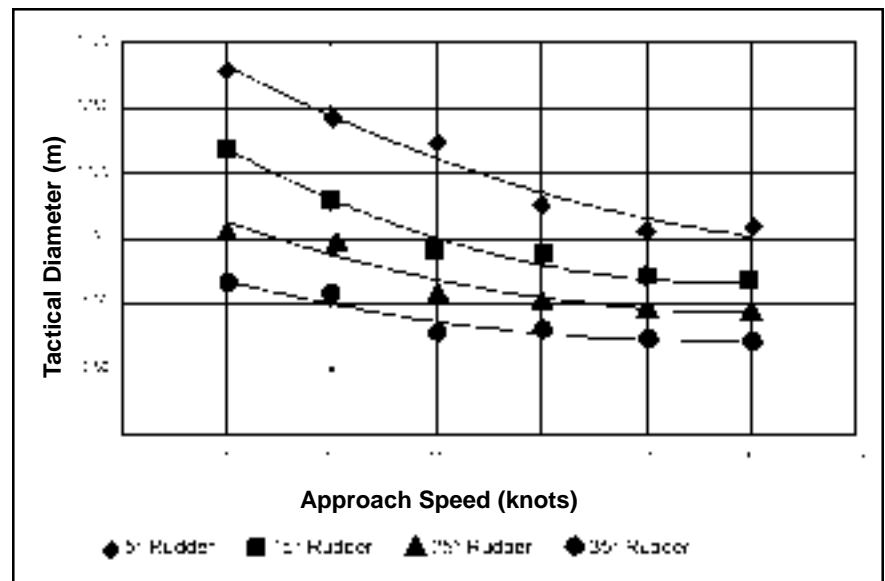

Fig. 1. Tactical Diameter versus Approach Speed



The frigate HMCS *Fredericton* in heavy seas. (DND photo)

clusions must be tempered with an understanding of these limitations.

Computer simulation of a frigate manoeuvring in severe sea conditions

The intent here is to illustrate the application of this simulation technology and provide some technical insight into the challenges and risks associated with manoeuvring in heavy seas. In such conditions, the line between seakeeping, manoeuvrability and controllability is blurred. Yet, as any seasoned sailor will attest, it all comes down to seaworthiness and the confidence a good ship will inspire in its crew.

The example here is that of a frigate executing a 360° turn with 35° of port rudder at 12 knots and 16 knots in a seaway with a significant wave height of nine metres and no wind. As Fig. 2 shows, at 12 knots the ship is obviously challenged, but apart from experiencing large rolls in the 20° to 30° range and rather abrupt changes in heading corresponding to

encounters with the largest waves of as much as 17 metres from crest to trough — arguably a broach in one instance— it is still successful in completing the turn. However, when the ship's speed is increased to 16 knots, the turn is completed without incident in two-thirds the time. On the other hand, when the simulation was run at a slower speed the ship was not able to complete the turn.

In a more general sense, data from these and hundreds of similar runs suggests that the maximum roll/heel angle is due to encountering larger waves of the irregular seaway rather than due to the turn-induced heel added to somewhat average roll angles for that same seaway. In calm to mild conditions, turn-induced heel is more likely to be the dominant contributor to the total roll/heel angle of a ship in a turn.

What appears to occur in heavy seas is that during the turn there are times when the ship is exposed to “worst headings” with respect to

motion. If an exceptionally large wave or group of large waves is encountered while the ship is on one of these headings, roll possibly coupled with an uncontrolled rapid and large heading change can be enough to result in capsizing. If the ship cannot turn effectively due to heavy sea conditions, it may become trapped on a worst heading (typically a beam or stern-quartering sea) for a prolonged period while trying to come around. Naturally, the longer a ship remains on a worst heading, the greater the odds are of encountering large waves which can result in resonant rolling, loss of stability on a wave crest, or loss of directional stability that can lead to a broach, or in the extreme, risk of capsizing.

For the portion of the turn when the ship is in following or stern-quartering seas, there is inherently more danger present than when the ship is simply trying to maintain course with the helmsman or autopilot actively working the rudders to compensate for yaw. Given our scenario

Simulated Frigate Turning Circle Manoeuvre

12 Knots

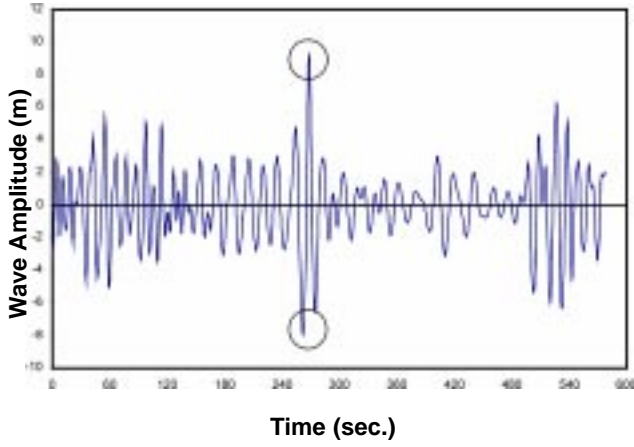

16 Knots

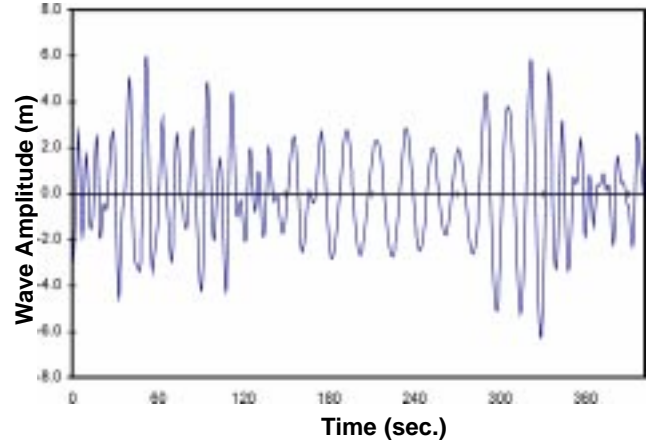

Wave Amplitude vs. Time

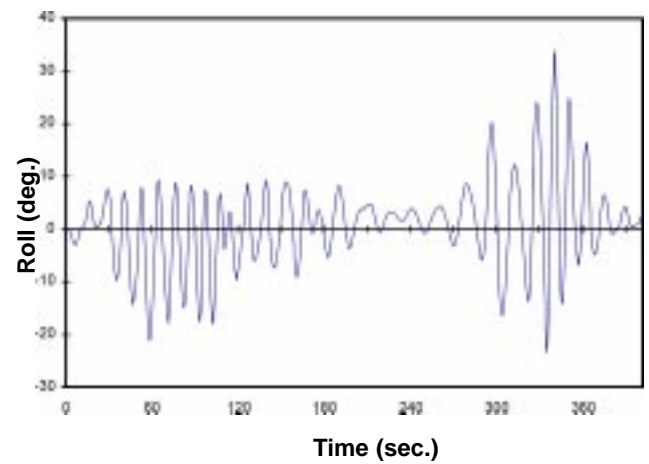
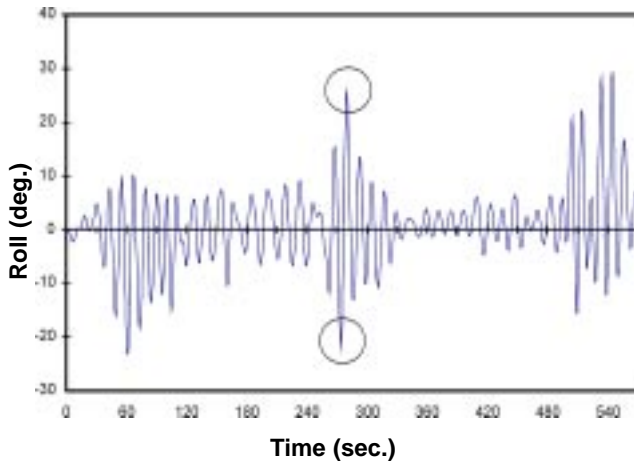

Roll vs. Time

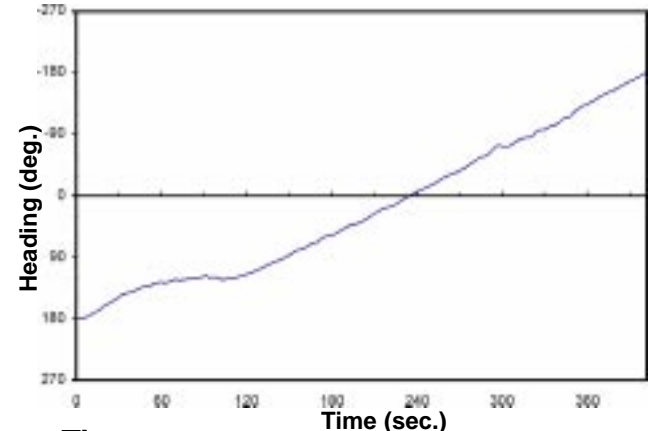
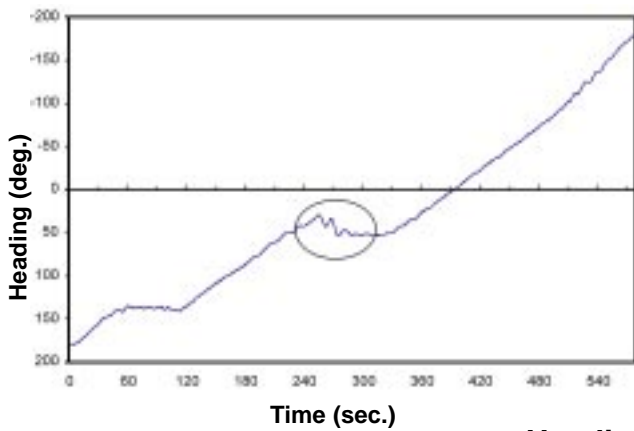

Heading vs. Time

Simulated Frigate Turning Circle Manoeuvre

Significant Wave Height = 9 metres
No Wind
35° Port Rudder

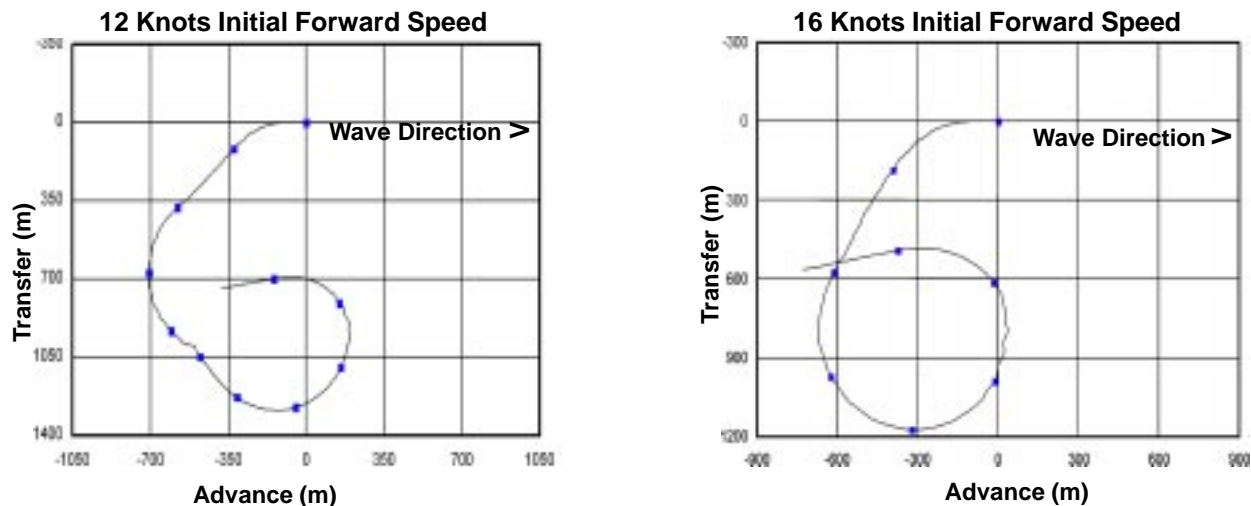

Fig. 2. As explained in the text, these two simulations of a frigate attempting a 360° turn, first at 12 knots and then at 16 knots in identical seaway conditions have produced much different outcomes. As shown above and at left, at 12 knots the frigate nearly broaches while encountering a 17-metre wave in stern-quartering seas. The ship rolls 25° and clearly has difficulty completing the manoeuvre. When the speed is increased to 16 knots, the ship completes the circle much more effectively in about two-thirds the time. Conversely, when the simulation was run with the ship travelling at much slower speed (*not shown*), the ship was unable to complete the turn.

for a turning ship, the rudders would typically be held at some constant large angle to try to turn the ship. If the rudders were in a wave trough or partially out of the water due to the ship pitching, the effectiveness of the rudders and propellers would be reduced (a situation which in itself impairs ship controllability). However, this situation can become even more dangerous as the wave crest moves to the stern of the ship and the rudders and propellers suddenly become much more effective as they dig in. With the ship now accelerating down the face of the wave (a classic recipe for a broach), the turned rudders could initiate or exacerbate a broach. The suggestion here would be to not stubbornly maintain rudder angle to try to complete the turn, but to work with the wave system to mitigate the situation.

Obviously, choosing the right moment to initiate or correct a course

change is an important consideration in heavy seas, and aggressive action is often required. Once on the desired course, a combination of large and anticipatory subtle helm corrections applied at the correct time is most effective.

On any heading there can be instances where the rudders and propellers completely lose their effectiveness as the stern comes out of the water. Maintaining heading control when this occurs could become impossible. If the encountered wave is sufficient to cause the ship to surf or to be carried in an exaggerated sway (sideways) fashion, the ship is pretty much at the mercy of the wave (i.e. total loss of directional control). In this scenario, possibly combined with a very large roll, having the deck edge dig into the water can trip the ship and lead to a capsize (*see the illustration on the inside front cover of this journal where this*

situation nearly results in the ship capsizing).

Going with the waves (i.e. following seas) is sometimes used as a tactic to reduce roll or heavy slamming, but this scenario is a recipe for broaching that can possibly lead to capsize. Avoiding high speed in following or stern-quartering seas is generally accepted as the best strategy for minimizing surf-riding and the possibility of broaching when, for tactical reasons, these headings cannot be avoided. In the worst of conditions, heaving-to by using minimal speed to maintain steerage in head and bow-quartering seas is prescribed as a survival tactic.

Presentation of turning difficulty in a seaway

Plotting a ship's track can effectively illustrate the difficulty of manoeuvring in a given seaway, although many plots will be required to cover a range of scenarios. *Fig-*

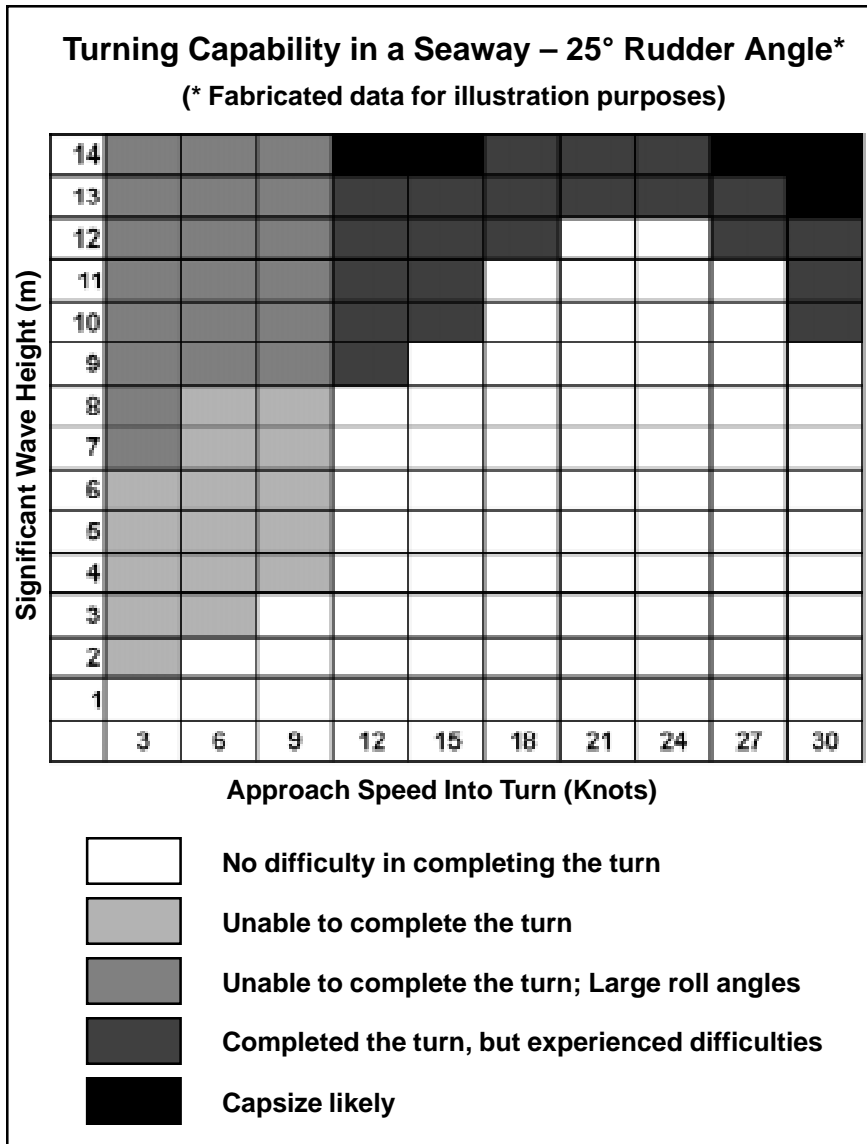

Fig. 3. Ship manoeuvrability data presented in a simple matrix format such as this can offer bridge watchkeepers an effective summary of general cautionary guidance for manoeuvring in various sea states.

ure 3 indicates in a matrix format the various degrees of turning difficulty for one specific ship using a given constant rudder angle for combinations of ship speed and wave height. Detail about the ship's behaviour is lost, but it is readily apparent where turning ability is diminished due to the seaway and where there is greater likelihood of capsizing.

Levels of degradation can be more finely defined in the matrix by indicating such factors as the likelihood of broach, the occurrence of periods of zero or negative turning rate, and the turning diameter, or time to complete the turn, as multiples of the calm-water values. If two

or more measures of difficulty occur simultaneously, they can be indicated with different or multiple colours within a box, or by adding symbols accompanied by footnotes. Additional plots would be required to cover turn difficulty for different rudder angles.

Conclusion

Manoeuvring characteristics based on such simulations cannot be taken as absolute. There are just too many variables with respect to all the possible seaways and to what was considered in the simulations to generate the data. For example, the variables being referred to here include: wave characteristics; wind; initial

heading relative to the waves; initially turning into or with the waves; applying more or less power to one shaft of a twin-shaft ship to help turn the ship; and different ship-loading conditions.

Although the data can be tailored to a specific ship, it must be remembered that such data and guidance can only be taken as an indicator of potential danger, subject to the quality of the simulation and the rigour taken in producing the data. Furthermore, the corrective actions of an experienced helmsman are not factored into these simulations. Nevertheless, the availability of simulation data in the form of matrix plots can be very useful as an onboard risk mitigation tool, augmenting seaman-ship doctrine regarding manoeuvring decision-making. In a training environment, the PC-based FREDYN program will allow seagoing personnel to run countless what-if situations, either scripted or of their own design, from the relative safety of the classroom.

Reference

1. Allied Naval Engineering Publication 70, Vol. 1, *Guidance for Naval Surface Ships Mission Oriented Manoeuvring Requirements*; and, Vol. 2, *Guidance for the Preparation of Onboard Manoeuvring Information*.



Michael Dervin is a hydrodynamics engineer in the Directorate of Maritime Ship Support in Ottawa, and is Canada's member with the NATO Naval Armament Group specialist team studying naval ship manoeuvrability. This article is derived from the section he wrote on this subject for ANEP 70.

MASIS Navy Implementation “Goes Live”

Article by LCdr Wade Knorr

December 15, 2003 marked the most important milestone to date for the Materiel Acquisition and Support Information System (MASIS) Project. On that day, following on the heels of previous rollouts, members of the naval community on the East Coast joined their colleagues on the West Coast and in the Maritime Equipment Program Management division (DGMEPM) in Ottawa as they began to log on to MASIS for the first time. With one turn of the key, the navy was able for the first time in its history to work within a fully integrated system that allows engineering, maintenance and financial information to be shared between DGMEPM at the centre, and HMC ships, the formations and fleet maintenance facilities (FMFs) on both coasts.

The navy is the first of the three services to receive MASIS, and the milestone represents the first truly coast-to-coast implementation of the system. The implementation was truly a team effort, as members from both the MASIS Project and the Maritime MASIS Acceptance Project logged some long, difficult and sometimes frustrating days to realize this achievement. In addition, the talents and dedication of people from many other organizations within the department were crucial to ensuring that the necessary processes and procedures were in place to make this rollout a reality.

Background

The MASIS Project was initiated during the mid-1990s to provide an integrated engineering and maintenance information system which would replace the myriad legacy systems that were in use throughout the Department of National Defence.

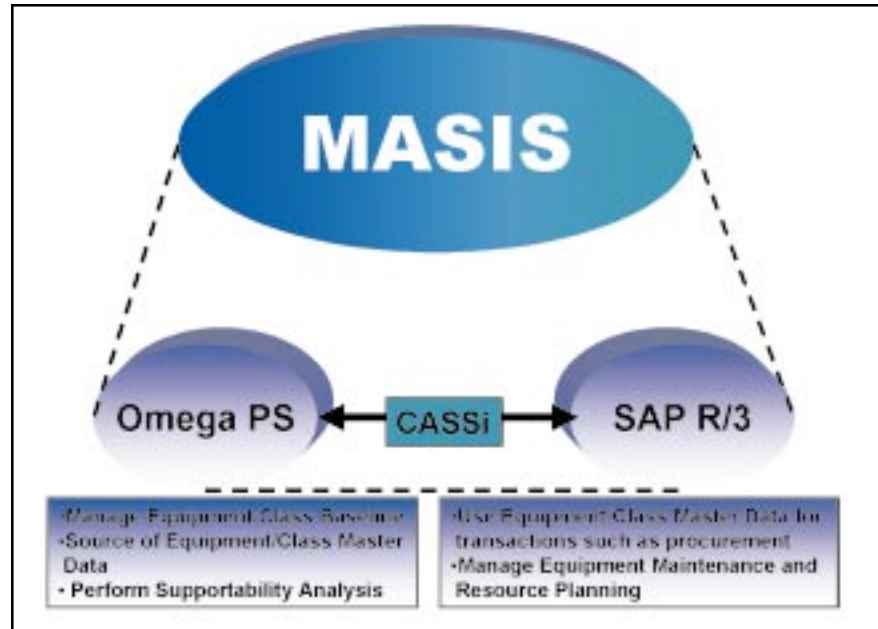

Fig. 1. Functional lines of demarcation between the two major application programs that lie at the core of MASIS.

MASIS would form the fourth cornerstone of department-wide support applications for DND, joining the existing triumvirate of the Financial and Managerial Accounting System (FMAS), the Canadian Forces Supply System (CFSS), and the Human Resources Management System (HRMS).

The primary mandate of MASIS is to provide support to operations by enabling:

- improved asset visibility;
 - procurement and maintenance process efficiencies;
 - more timely and comprehensive information for decision-making; and
 - improved operational support planning,
- all of which lead to improved operational results.

To fulfill this mandate, MASIS is intended to address materiel acquisition and support requirements at all

levels in the following key business areas:

- engineering and maintenance;
- financial (linked to FMAS);
- procurement (linked to CFSS);
- project management;
- business planning;
- workforce management to support operations;
- document linking; and
- reporting.

MASIS has adopted a phased approach to implementation based on departmental priorities and anticipated benefits determined through an evolving business case. The functionality developed during each phase builds upon that developed during previous phases, resulting in an ever-expanding solution set to benefit all MASIS users. MASIS is currently taking a “strategic pause” to focus on consolidating and enhancing the existing solution and to prepare for the next development phase which begins in April 2006.

The software architecture concept for MASIS relies on commercial off-the-shelf software products. At the core of MASIS lie two key application programs — Omega PS and SAP R/3 — with a Complex Asset Supportability System Interface (CASSi) linking the two. *Figure 1* details the functional lines of demarcation between the two applications.

The engineering-oriented Omega PS provides a tool for conducting logistic support analysis, configuration management of equipment and class baselines, and maintaining equipment/class master data such as the Naval Equipment Index, Equipment Registration Numbers and Equipment Support Lists. The maintenance-oriented SAP R/3, using master data provided by Omega PS through the CASSi interface, and by using interfaces to CFSS and FMAS, provides an integrated tool for planning, executing and tracking maintenance work. SAP R/3 also enables the transaction of support functions such as materiel procurement, project management, financial management of both dollars and delegated maintenance budgets, and workforce management.

Naval Implementation

In early 2001 the Chief of the Maritime Staff and DGMEPM, having jointly determined that MASIS would fulfill vital naval engineering and maintenance support requirements, agreed to have the navy undertake the first “end-to-end” environmental rollout. Following a detailed planning and scoping exercise, the MASIS navy implementation was defined to encompass materiel acquisition and support functions within DGMEPM, CMS, Maritime Forces Atlantic, Maritime Forces Pacific, the navy’s two fleet maintenance facilities and HMC ships. This was to include harmonization with other functional areas and units (such as Base Supply and Formation Logistics) to provide more efficient and effective materiel acquisition and support delivery to the fleet. This in turn would provide

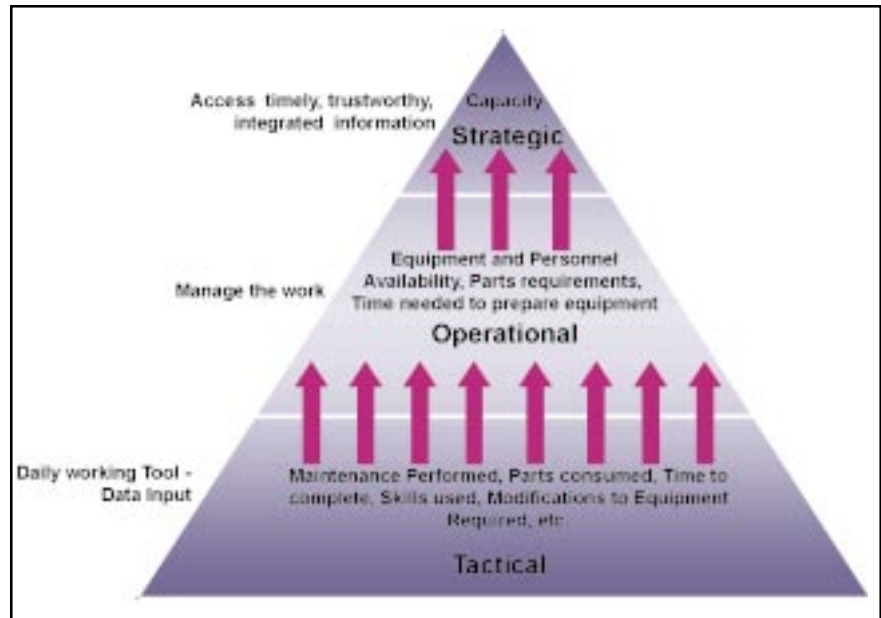

Fig. 2. The single most important benefit resulting from MASIS is an integrated data environment offering multi-level usage of the same accurate and timely source data.

increased operational support and improved operational capability.

The MASIS navy implementation has replaced the following legacy naval engineering and maintenance systems: YORVIK (FMF *Cape Scott's* maintenance management information system), OASIS (FMF *Cape Breton's* maintenance management information system), and WORKMAN (the DGMEPM project work management system). The shore- and ship-based elements of the Configuration Management Information System (CMIS MK II and CMIS/S) were to be replaced as well, but the lack of a robust SAP mobile engine at the time of solution design and the decision to implement a corporate deployed solution vice a navy-specific one meant that the rollout of MASIS to HMC ships would have to be postponed until the next development phase in 2006. Until then, CMIS MK II and CMIS/S will have to remain in service, with two newly developed interfaces providing the end-to-end MASIS functionality. (The new maintenance interface is designed to relay Maintenance Action Form data between CMIS/S-equipped ships, WebMAF users and MASIS. The new configuration management interface syn-

chronizes master data among Omega PS, SAP R/3, CMIS MK II and CMIS/S.)

Benefits of MASIS

MASIS will provide significant benefit to the navy across the full spectrum of naval engineering and maintenance activities. Benefits include:

- improved maintenance management capability;
- improved information sharing between the formations, fleet maintenance facilities and DGMEPM;
- capability to perform realistic trend analysis;
- capability to perform both baseline and “instance” configuration management of equipment and systems;
- visibility into all aspects of lifecycle and configuration management at the serialized item level — a quantum leap forward in traceability and maintenance history tracking of individual equipment items;
- integration of project management aspects in one tool;
- automated workflow;
- ability to determine maintenance status of ships for various deployment scenarios; and
- ability for formations to conduct capacity evaluations.

All of these benefits are underpinned by the single most important benefit resulting from MASIS — an integrated data environment that provides multi-level usage of the same accurate and timely source data (see Fig. 2). The data created in the course of transacting ordinary, everyday naval E&M support functions at the tactical level is now consistent across the navy and can be rolled up to create the accurate, timely information needed to manage work at the operational level. This in turn provides the consolidated engineering and maintenance information necessary to make strategic-level decisions. The ability to collate, sort and combine the source data to generate key reports to support decision-making at all levels is almost unlimited, and can be used to help the navy answer key questions such as:

- Which equipment is ready to deploy on operations?
- How much will it cost to get ready to deploy?
- Are the maintenance costs of naval equipment increasing, decreasing, or staying constant?

The table at Fig. 3 compares and contrasts some key, specific naval engineering and maintenance functional capabilities prior to and after the MASIS navy implementation.

What's Next?

Although the benefits MASIS brings to the navy are significant, tangible and currently available, considerable work remains to consolidate the gains to date. It remains to complete the navy's transition to full MASIS usage and to enhance the solution to achieve the full potential of the system. Completing this work and preparing for the next development phase will be the primary tasks for the MASIS and MMAP projects over the next two years.

It is of interest to note that the USN, which is integrating its own four SAP-based applications into an optimized single tool, has already demonstrated "vastly better than expected benefits" from the enhanced information their MASIS-like systems are providing. These include significant reductions in maintenance time and financial reconciliation time, and in improved accuracy

of maintenance transactions. All of this points the way to equally significant improvement potential for the Canadian navy.

The engineering and maintenance solution that has been implemented within the navy is now the baseline for future rollouts of MASIS to the army and air force. So while this is an important point in the life of the MASIS Project, and DND as a whole, there is still much left to do to provide the department with a single integrated tool for materiel acquisition and support.

For More Information

To learn more about MASIS or the Maritime MASIS Acceptance Project (MMAP), please visit the following websites:

MASIS – <http://cosmat.ottawa-hull.mil.ca/masis/masis.htm>

MMAP – <http://navy.dwan.dnd.ca/english/dgmfd/dmscr/MMAP/intro.asp>

You may also direct your specific enquiries to:

- Capt(N) Mark Eldridge, MASIS Project Manager, (613) 992-7538
- LCdr Wade Knorr, MASIS Naval Implementation Team Lead, (613) 996-1996
- Mike Veinot, MASIS Communications Officer (613) 992-1614
- Cdr Francis Pelletier, MMAP Project Manager, (819) 994-8866
- LCdr Brian Corse, MMAP Deputy Project Manager, (819) 944-5699



LCdr Knorr is the MASIS Naval Implementation Team Lead in PMO MASIS in Ottawa.

Previously	Currently
CMS, Formation and DGMEPM staffs repeatedly expended much effort to determine ship readiness.	Real-time ship status available. Effort to prepare systems/ship immediately available on-line to all staffs at same time.
Cost recovery for DMBs (center and coasts) very labour intensive.	Fully automated process that is transparent to the end user.
Ship structures peculiar to each coast and centre.	Single ship structure regardless of location (both for baseline and instance configuration management). Common technical language.
Cost planning/business planning conducted as a separate exercise. Attempts to reconcile with actual work very labour intensive.	Cost planning/business planning in MASIS. Reconciliation reinforced by system.
Complex maintenance planning conducted in various tools separate from the maintenance system.	Complex maintenance planning and execution conducted in MASIS.

Fig. 3. Before and After MASIS Comparison

Greenspace: Maritime Environmental Protection

Project Update:

The Big Picture on Oil Pollution Abatement

Article by Dan Vachon

The Canadian navy's Maritime Environmental Protection Project (MEPP) is charged with ensuring HMC ships are compliant with national and international environmental protection regulations. The work mainly involves augmenting existing pollution control systems with appropriate new technology and procedures, much of it directed toward compliance in the area of oil pollution abatement.

Shipboard bilge management usually centres on some sort of oily water separation and treatment system designed to provide ships with the ability to manage bilge levels generated during normal operations. Important as they are, oil/water separators (OWS) are not intended to eliminate the need for, nor the cost of, port services associated with bilge fluid offload. In accordance with the Canadian Forces *Naval Engineering Manual*, strict attention must be paid to avoiding an accumulation of fluids in the bilges by minimizing the amount of fuel, oils and other deleterious substances that enter the bilge. Every attempt must also be made to ensure bulk oil accumulation in bilges or sullage tanks does not get processed through the OWS. Since high fluid levels in the bilge pose a direct risk to machinery, personnel and the natural environment, and also contribute significantly to long-term corrosion of hull and machinery, bilges are to be kept clean and dry. Oil from machinery sumps must never be drained directly to the bilge.

Regardless of the system configuration or equipment fitted, the quality of overboard discharge must meet or exceed government and interna-

tional limits and regulations. Maritime Command Order (MARCORD) G-18 is quite specific in that oily water discharge must contain less than zero parts per million of oil in water in special operating areas such as Arctic waters, less than five parts per million in inland waters, and less than 15 ppm in other areas. The MARCORD further stipulates that oil/water separators must be equipped with a Transport Canada approved oil content monitor that can monitor effluent quality on the discharge side of the OWS and reroute discharge to the bilge when limits are exceeded.

To adhere to these stringent rules, the Maritime Environmental Protection Project is conducting work in the following areas to address and rectify ongoing concerns. A new Hydromem™ OWS that was to be purchased and fitted in *Halifax-* and *Iroquois-* class ships with minor modifications (*Maritime Engineering Journal*, June 1998) has presented technical challenges and installation delays. To resolve this, studies and tests relating to the problems associated with the Hydromem have been conducted with the ongoing support of the Naval Engineering Test Establishment (NETE) in Montreal. MEPP staff have also focused on such other aspects of bilge management as configuration issues on the *Halifax*, *Iroquois* and *Victo-*



This working Hydromem unit is installed at the Canadian Forces Naval Engineering School in Halifax to support QL5 Mar Eng Tech training.

ria classes, training for marine systems engineering staff, and rectifying problems with the Hydromem OWS itself.

Configuration Issues

On *Halifax-* class vessels the configuration of the oily water collection tank (OWCT) does not permit proper separation of the oil and water due to its internal construction. Stiffeners and ribs in the tank act like a Mixmaster™ when the ship is rolling and pitching at sea. As a result, slugs of pure oil are being drawn into the oil/water separator and through the membranes. To rectify this problem, an engineering change is under development to install a 900-litre batch tank between the OWCT and the OWS to allow proper separation of oil and water. The tank will be fitted with a sight glass to see the oil/water interface, an oil/water interface sensor to send signals to the Hydromem controller, maximum

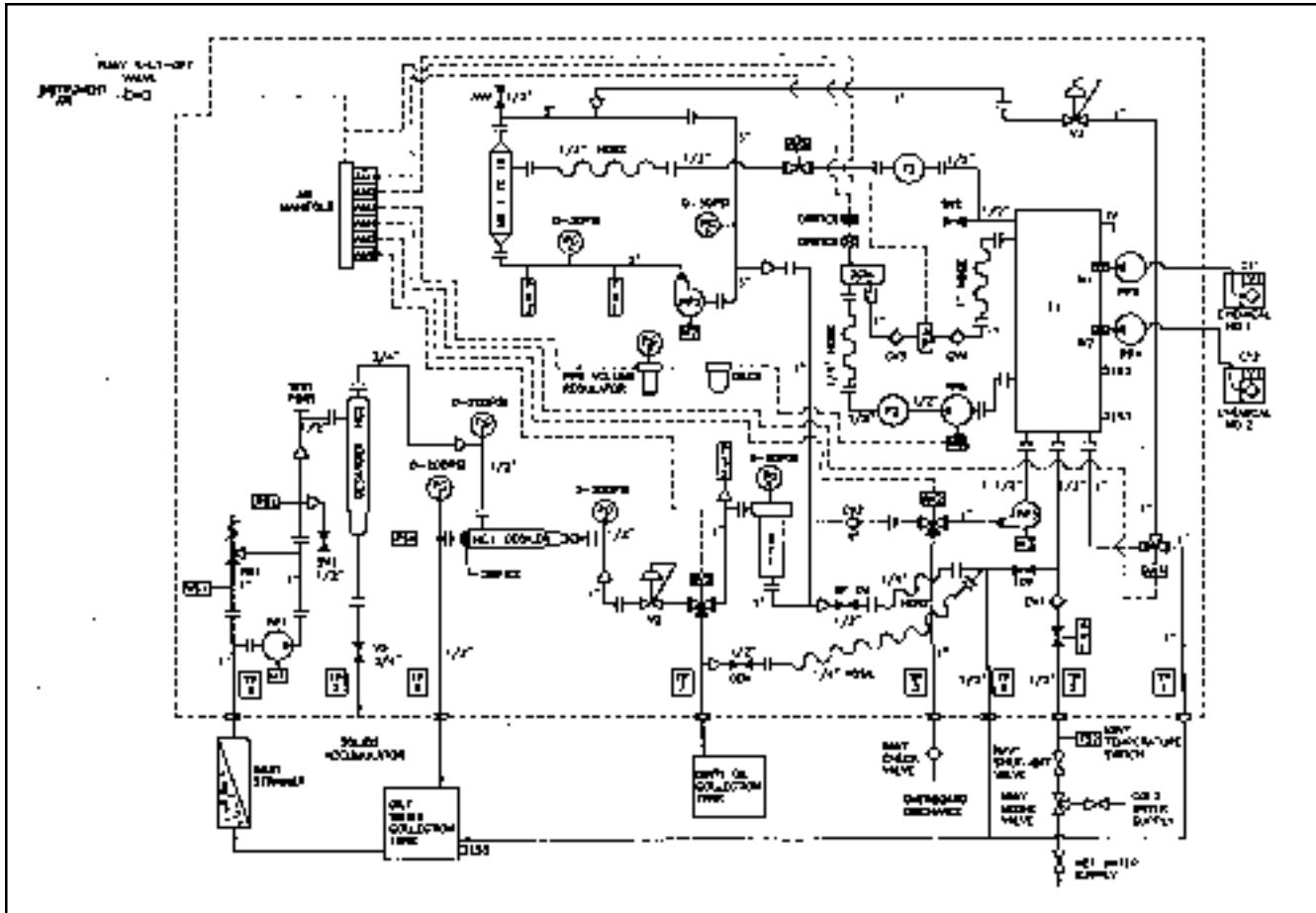

Fig. 1. A schematic of the Hydromem oil/water separator system test rig at the Naval Engineering Test Establishment in Montreal.

and minimum float switches, and a funnel-type skimmer that will draw raw oil from the top of the OWCT and send it to the recovered oil tank. A separate pump will be fitted between the OWCT and the batch tank to process oily water in batches.

Another engineering change being implemented is the rerouting of the diesel enclosure drains directly to the recovered oil tank to minimize the amount of oil being dumped into the bilge. Bilge pumps will also be converted to Wilden air-driven pumps to overcome difficulties in pumping to deck discharge fittings, to reduce mechanical emulsification, and to prevent loss of suction.

Iroquois-class ships are currently fitted with a 900-litre tank which is being used as both a batch tank and an oily water collection tank. This

severely limits storage space for oily water. Engineering changes are being implemented to convert a void space to an OWCT, thereby increasing storage capacity and providing better separation of oil and water. The current OWCT will be converted to a batch tank to enable positive separation of oil and water prior to drawing the water phase from the bottom of the tank and processing it through the oil/water separator.

Another *Iroquois*-class engineering change is under way to rectify small problems. The engineering change includes: increasing the funnel skimmer drain line to increase flow to the dirty oil tank; doubling the holding capacity of the dirty oil tank; adding a three-way valve to discharge Hydromem effluent to the OWCT in harbour; changing the

float switches on the OWCT; adding a gauge glass to the cleaning/permeate tank on the Hydromem; and, as mentioned, fitting a Wilden air-driven bilge pump to increase upper-deck discharge capability.

To comply with the Canada Shipping Act and MARPOL standards, *Protecteur*-class ships have been fitted with an approved Deckma oil content monitor between the 227-litre-per-minute Sarex oil/water separator and the overboard discharge.

For the *Victoria*-class submarines, bilge management and oily water production sources and rates are a major area of concern because of their direct impact on trim and ballast, on operational costs (pumping costs in ports), and even on the possible length of a mission due to the



Iroquois-class ships are currently fitted with a 900-litre tank which is being used as both a batch tank and an oily water collection tank. This severely limits storage space for oily water. (CF Combat Camera photo by MCpl Brian Walsh)

minimal storage capacity for oily bilge water. The MEPP and Naval Engineering Test Establishment are currently conducting a study of the standard operating procedures, bilgewater production sources and the bilge system configuration to improve shortfalls in the current system in the near and long term.

Training

Effective training and awareness are key to overcoming recurring problems and pitfalls in managing bilge water and reducing operational costs. For the QL5 Mar Eng Tech training, a new qualification and standards plan has been developed which details the standard for bilge management training. Given the short period of time for hands-on training and the low volume of course delivery *vis-à-vis* the turnover of maintainers on board ships, there is need to deliver training to the maintainers between course serials and also to train the trainers.

To this end, the Maritime Environmental Protection Project tasked NETE to develop and deliver a short course on bilge management and on

the operation of the Hydromem OWS unit. On the basis of the two-day pilot course, the Directorate of Maritime Training and Education has approved delivery of four standalone courses by fleet school staff over the next three fiscal years. Hydromem training has also officially been incorporated in the QL5 course. An operational Hydromem unit has already been installed at the CF Naval Engineering School in Halifax (Fig. 1), and installation of a similar unit at the Canadian Forces Fleet School in Esquimalt is now under way. Requirements for Marine Systems Engineering Officer training are also being investigated.

Hydromem in the Fleet

Hydromem systems are currently fitted on board HMC ships *Iroquois*, *Athabaskan*, *Algonquin*, *Halifax*, *Ville de Québec*, *Montréal*, *Calgary*, *Winnipeg* and *Vancouver*, and three more units will be installed during fiscal year 2004/05. Some ships have reported operational problems with the Hydromem, such as premature fouling of the membranes, but these problems should be resolved through

bilge system reconfiguration and more effective training.

The Hydromem unit (Fig. 2) consists of a few basic pieces of equipment: a de-sander and de-oiler for pretreatment, a bag filter to protect the membranes, the membranes, a number of pumps and air-controlled valves, and an oil content monitor fitted to the discharge. The membranes, like those in all membrane-based oil/water separators, are critical to the operational effectiveness of the unit. Turbulent flow and predetermined operating pressures of oily water passing through the membranes are essential for ensuring the permeate has an oil content of less than 15 ppm at a minimum output rate of 3.78 litres per minute.

The current version of the Hydromem uses hollow-fibre polymer membranes. A prototype membrane from a different supplier proved to be much more resistant to fouling, but produced a permeate discharge with unacceptably high oil content. A second prototype tested at NETE and evaluated at sea was also unsuccessful due to poor quality control of the material and the dimensions of the membranes.

Other findings from testing of the Hydromem OWS unit are as follows:

- The de-sander and de-oiler used in the pretreatment phase to separate solids and gross oil located in the feed to the recirculating pump have had a spotty record. Because their effectiveness has always been questionable, NETE will conduct tests of these important components.
- The detergent and acid cleaning cycle used to restore the flux in the membranes happens too frequently and produces too much waste water (i.e. approximately 150 litres per cleaning cycle). This waste water has to be processed by the Hydromem, which is counterproductive to the goal of eliminating as much water

from the bilge as possible. NETE has been tasked to maximize the efficiency of the cleaning cycle. Results are expected to be published this fall.

Conclusion

The membrane-based Hydromem oil/water separator unit may have its challenges, but for the moment it represents the state of the art in OWS technology. This will likely change over the next five to ten years as maritime engineers strive to meet new, more stringent anti-pollution standards that will almost certainly be introduced by the International

Maritime Organization and other regulating agencies. For this reason, Maritime Environmental Protection Project staff will continue to investigate new oil pollution abatement technologies that show good potential for Canadian naval shipboard application.

Comments and feedback from the readers would be greatly appreciated. You can reach Mr. Daniel Vachon at vachon.da@forces.gc.ca or by phone at (819) 994-8846.

References:

1. Stephenson, Lt. Cdr (RN) D., "The Royal Navy — Meeting the environmental challenge of the 21st Century," *Journal of Naval Engineering*, 40(1) 2001.
2. Canadian Forces *Naval Engineering Manual*.



Dan Vachon is a project engineer for oil pollution abatement systems with DMSS 4-8 in Ottawa.

2003 Naval Technical Officer Awards

*Text by Lt(N) Ryan Kennedy,
CFNES Officer Training Division*

Photos by Brian McCullough

The Naval Technical Officer Awards are presented annually to recognize the achievements of our best junior Naval Technical Officers in their pursuit of leadership and engineering excellence. The 2003 NTO Awards were presented at the annual Eastern Region naval technical officer mess dinner on April 29, 2004 at the CFB Shearwater officer's mess.

CAE Award



The CAE Award is presented annually to the candidate with the best academic performance on the MS Eng Applications Course. Ms. Wendy Allerton, CAE Inc., presented the award to **SLt Lenny MacArthur**.

Lockheed Martin Canada Award



The Lockheed Martin Award is presented annually to the best overall candidate achieving the NCS Eng qualification. LCdr (ret.) Stan Jacobson of Lockheed Martin Canada presented the award to **Lt(N) Tim Gibel**. Runners-up were Lt(N) Brekke Beyer, Lt(N) Melanie Espina and Lt(N) Jay Thor Turner.

MacDonald Dettwiler Award



The MacDonald Dettwiler Award is presented annually to the best overall Naval Technical Officer who has achieved Head of Department qualification. Mr. Lee Carson of MacDonald Dettwiler presented the award to **Lt(N) Denis Pellichero**. Runners-up were Lt(N) Robyn Locke, Lt(N) Chad Kabatoff and Lt(N) Luke Schauerte.

(Awards cont'd next page)

Naval Technical Officer Awards

Naval Officer's Association of Canada (NOAC) Award



The NOAC Award is presented annually to the candidate with the best academic performance on the Naval Engineering Indoctrination Course. Cdr (ret.) Rowland Marshall, NOAC, presented the award to **NCdt Daniel Wilmott**.

Mexican Navy Award



The Mexican Navy Award is presented annually to the MS Eng candidate who, in the opinion of his peers and instructors, best exemplifies the qualities of a Naval Technical Officer. Mexican Navy Captain Francisco Ortiz, accompanied by his wife Elsa, presented the award to **Lt(N) William Wensel**.

Special Retirement Award



RAdm Glenn Davidson, former Commander of Maritime Forces Atlantic, presented a special retirement award to **LCdr (ret.) Bill Greenlaw** who was retiring after more than 43 years of service to the fleet. The award recognized Bill's 28 years of naval service, followed by 16 years as a General Electric gas turbine field service specialist. *Bravo Zulu, Bill!*

Northrop Grumman Award



The Northrop Grumman Award is presented annually to the candidate with the best academic performance on the NCS Eng Applications Course. Cdr Don Flemming presented the award to **SLt Anthea Chang**.

Peacock Award



The Peacock Award is presented annually to the best overall candidate achieving MS Eng qualification. Cdr (ret.) Michel Bouchard, Peacock Inc., presented the award to **Lt(N) Tom Sheehan**. Runners-up were Lt(N) Jack MacDonald, SLt Sean Williams and SLt Andrew Willis.

Mack Lynch Memorial Award

The Mack Lynch Memorial Award is presented annually to the NCS Eng candidate who, in the opinion of his peers and instructors, best exemplifies the qualities of a Naval Technical Officer. The award winner was **SLt Kevin MacDougall**, who was unable to attend the presentation ceremony.



Bravo Zulu!

Book Review

Operation Apollo: The Golden Age of the Canadian Navy in the War Against Terrorism

Reviewed by Bridget Madill

**Operation Apollo:
The Golden Age of the
Canadian Navy in the War
Against Terrorism**

by Richard Gimblett

Magic Light Publishing in co-
operation with DND and
PWGSC, 2004

ISBN 1-894673-16-6

Sometimes you can tell the flavour of a book by its cover. In the case of Richard Gimblett's recently published, *Operation Apollo: The Golden Age of the Canadian Navy in the War Against Terrorism*, artist John Horton's striking cover painting of an Iroquois-class destroyer shadowing a merchant vessel on a moonlit sea is just a taste of the book's content.

Chock full of full-colour photographs, paintings and charts, this volume is a visual delight. But it is much more than a picture book. In *Operation Apollo*, retired naval combat officer and naval historian Richard Gimblett, a research fellow with Dalhousie University's Centre for Foreign Policy Studies, has produced a definitive report on the role played by Canada's navy in the post-September 11, 2001 War on Terrorism. The book is an excellent companion volume to Gimblett's earlier publication, *Operation Friction: The Canadian Forces in the Persian Gulf, 1990-1991*, co-authored with Maj Jean Morin.

With its foreword by VAdm Ron Buck, *Operation Apollo* is an authorized, unofficial account of Canada's naval contribution to the campaign against terrorism. But it is no propa-

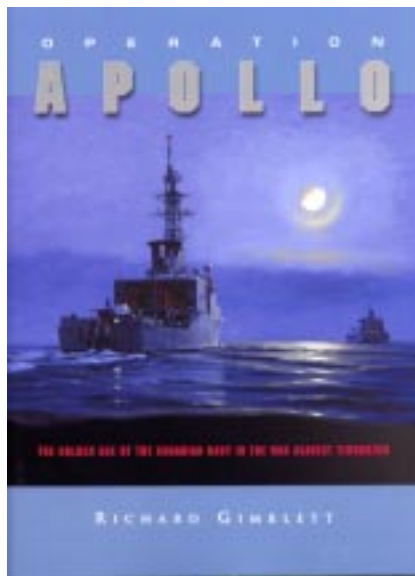

ganda piece. Gimblett bluntly points out the difficulties the navy had to overcome after years of budget uncertainties, personnel reductions and delays in equipment renewal to prepare for these operations. Dedicated to "the men and women of Canada's navy and to their families," *Operation Apollo* ultimately commends the navy's success in the face of those challenges.

The measure of that success is astounding: Ninety-five percent of seagoing personnel were deployed for six months or more; 16 of the navy's 18 major warships served overseas in support of Op Apollo; the navy conducted 20,000 hailings of merchant vessels, 600 boardings (fully half the coalition's total), 11,000 hours of maritime air support, and 500 escort missions through the Straits of Hormuz. *Operation Apollo* puts a human face on this monumental achievement. Accompanying the book on DVD is an engaging half-

hour movie (viewable in English or French) that incorporates news footage with other video and short interviews to tell the story of Operation Apollo. The book and DVD complement each other well.

What really sets this package apart is Richard Gimblett's determined attempt to acknowledge the contributions of individuals. Wherever possible he identifies people in photos, and attributes the photographs and paintings to the individual photographer or artist. In this sense, *Operation Apollo: The Golden Age of the Canadian Navy in the War Against Terrorism* will be a very personal book for the many Canadians who participated in, and supported, Op Apollo in so many capacities.



Bridget Madill is an associate editor with Brightstar Communications in Ottawa.

News Briefs

RCNC Class of '46 Scholarship



LCdr Marc Lapierre, Combat Systems Manager for PMO FELEX, has won the Royal Canadian Naval College Class of '46 Scholarship. The award is made annually to a regular force member of the naval environment who graduates the Royal Military College of Canada with the highest academic average in a postgraduate program. LCdr Lapierre completed

his master of applied science degree in electrical engineering last June. His thesis, "An Ultrawide-band Monopole/Dielectric Resonator Antenna," presented a new type of wideband antenna design for wireless communication devices which exceeds the impedance bandwidth response of most antennas currently available

for the cell phone market.

The scholarship award consists of a prize valued up to \$500 selected by the recipient. (Marc chose a digital camera.) The award was made by RMC Comandant and Vice-chancellor **BGen Jean Leclerc** on May 21.

Félicitations, Marc !



(MOSART Cont'd)

Technicians. Unlike traditional CF occupational analyses that examine one occupation at a time, this study examined all of the Combat Systems Tech occupations at the same time.

Overall, 74 percent of CS Techs responded to the survey. After several weeks of analysis, the study team identified some 120 core CS Tech jobs. Over the next several months the team will develop job descriptions that will eventually form the basis of a new "job-based" specification. This will define both occupational and generic jobs applicable to these personnel, and will highlight possible career paths individuals might follow. Not only will this superior level of detail help provide a better trained, more focused work force, it will enable members to understand the paths they must follow to achieve their own particular career goals.

A similar study by the Marine Systems Tech study team incorporates the Marine Engineering Mechanic, Marine Engineering Technician, Marine Engineering Artificer, Marine Engineering System Operator, Hull Technician, Electrical Technician, and Marine Electrician occupations into one "career field" analysis. This team carried out its survey in two sessions over the May/June time frame. Once all the data has been collected and processed, the team will begin the analysis process that will identify the core MS Tech jobs. Survey return rates and estimates of the number of jobs are not yet known. — **LCdr Garry Pettipas, Directorate of Military Human Resources, Ottawa** 🇺🇸

Joint Support Ship

On April 16, 2004 the Minister announced the government's intention to procure three joint support ships for the Canadian Forces. The Minister stated that the competition for the design and development of JSS will be conducted in several phases: prequalification, project definition and project implementation. Prequalification will begin with Treasury Board granting preliminary project approval, and end with the selection of two qualified consortia. The consortia will be awarded a contract to produce and deliver a proposal consisting of a preliminary ship design, a project implementation plan and a service support plan. A winning bidder will be selected at the end of the definition phase. The successful consortium will be awarded two separate, but related, contracts — one for the design and construction of the joint support ships; the other for the life-

time in-service support of the vessels. Delivery of the first ship is scheduled for fall 2011, with final ship delivery in fall 2014. — **PMO Joint Support Ship** 🇺🇸

MOSART Update

In the last issue of the *Journal* the Branch Adviser mentioned that the Military Occupational Structure Analysis Redesign & Tailoring Project would be conducting analyses of naval occupations. In fact, within MOSART, four distinct "career field" study teams are examining the work and occupational structure of Naval Officers, Naval Combat Operators, Marine Systems Technicians and Combat Systems Technicians.

In mid-March of this year an occupational analysis survey was administered to Naval Electronics Technicians and Naval Weapons

Steiner Regatta — Ottawa's "Can-UK" Fun Day on the Water

Story and photos by Brian McCullough



The Nepean Sailing Club was the scene of the annual Steiner Regatta sailing fun match between the Canadian and British naval communities in Ottawa on September 19. Although Canada's Simon Igici and Brenda Givins (*left*) won the most dinghy races, team scoring placed the U.K. boats highest overall for the third year in a row. Photos: Group Captain Tim Brewer, Naval & Air Adviser with the British High Commission, presents the Steiner "Cup" to RAF exchange officer Squadron Leader Richard Grainger (*inset, top*); Sqn Ldr Richard Grainger gets ready to set out with 15-year-old Claire Webster (*below*); LCdr Peter Egener under sail with nine-year-old son Matthew (*below, left*).





News

CANADIAN NAVAL TECHNICAL HISTORY ASSOCIATION

New domain name for CNTHA website

Further to what we reported in the Fall 2003/Winter 2004 issue of *CNTHA News*, the website for the Canadian Naval Technical History association can now be accessed at: <http://www.cntha.ca>



CNTHA News

Est. 1997

CNTHA Chairman
RAdm (ret.) M.T. Saker

Secretary
Gabrielle Nishiguchi

**Directorate of History and Heritage
Liaison**
Michael Whitby

DGMEPM Liaison
Capt(N) P. Hoes

**Maritime Engineering Journal
Liaison**
Brian McCullough

**Newsletter Production Editing
Services by**
Brightstar Communications
Kanata, Ontario

CNTHA News is the unofficial newsletter of the Canadian Naval Technical History Association. Please address all correspondence to the publisher, attention Michael Whitby, Chief of the Naval Team, Directorate of History and Heritage, NDHQ Ottawa, K1A 0K2. Tel. (613) 998-7045, fax 990-8579. Views expressed are those of the writers and do not necessarily reflect official DND opinion or policy. The editor reserves the right to edit or reject any editorial material.

Canadian Naval Defence Industrial Base Project to conduct oral history interviews

The CANDIB committee's mission under the Canadian Naval Technical History Association is to gather and document as much historical information as possible on naval construction programs and the effect they have had on Canadian industry. We hope to identify how Canadian industry has responded to the challenge of naval requirements over the years, and how the national industrial base has been affected by these naval programs, identifying any direct spin-off benefits that arose. We also hope to trace the legacy of this developmental activity, calling on the experience and recollections of as many people as possible who were involved in any way in these important events in Canada's history.

As it is proving difficult to get people to write down their experiences, one of the initiatives of the committee is to conduct and record oral interviews. The Directorate of History & Heritage has generously offered its financial support for this endeavour, and the committee will shortly be acquiring suitable audio recording equipment. To get started on the right course, two representatives from the CANDIB committee attended an oral history seminar held at the Canadian War Museum in early June. We anticipate conducting interviews on the two coasts and in the Ottawa area starting this fall. The committee is currently assembling a list of potential persons to interview.

To improve our communication with the naval and industrial community, we are also working on a website to showcase our efforts. Anyone who would like to learn more about CANDIB is invited to contact Tony Thatcher by phone at (613) 567-7004 ext 227, or by e-mail: tony.thatcher@snclavalin.com



Oral History Interviews

The CANDIB Project is looking for people to interview...and to conduct interviews. If you have personal experience with the industrial aspects of Canadian naval shipbuilding or naval equipment

procurement programs, please contact Tony Thatcher to see how you can contribute to this major effort to capture an important part of Canada's naval technical history.

