

119 Modification and Testing  
of a Portable Reciprocating  
Kiln for Cleaning Oiled  
Sand and Gravel

The Environmental Studies Research Funds are financed from special levies on the oil and gas industry and are administered by the National Energy Board for the Minister of Energy, Mines and Resources, and for the Minister of Indian Affairs and Northern Development.

The Environmental Studies Research Funds and any person acting on their behalf assume no liability arising from the use of the information contained in this document. The opinions expressed are those of the authors and do not necessarily reflect those of the Environmental Studies Research Funds agencies. The use of trade names or identification of specific products does not constitute an endorsement or recommendation for use.

**ENVIRONMENTAL STUDIES RESEARCH FUNDS**

**Report No. 119**

**March 1992**

**MODIFICATION AND TESTING OF A PORTABLE RECIPROCATING KILN  
FOR CLEANING OILED SAND AND GRAVEL**

**S.L. ROSS ENVIRONMENTAL RESEARCH LIMITED**

**OTTAWA, ONTARIO**

**Scientific Authorities: Mr. Gary Sergy  
Ms. Monique Punt  
Ms. Caroline Ladanowski**

The correct citation for this report is:

C. Guénette. 1992. Modification and testing of a reciprocating kiln for cleaning oiled sand and gravel. Environmental Studies Research Funds Report No. 119. Calgary. 46p.

Published under the auspices of the  
Environmental Studies Research Funds  
ISBN 0-921652-20-8  
©1992 S.L. Ross Environmental Research Limited

## ABSTRACT

*A full-scale prototype reciprocating kiln, designed for removing oil from oiled beach material (cobble sized and smaller) by incineration was for oil removal efficiency and stack emissions using several representative types of beach sediment and oil.*

*Beach sediment used in the testing included gravel, sand and a 1:1 mixture of sand and gravel. Each was oiled with fresh, weathered and emulsified crude and Bunker "A", at oil loadings ranging from 0.05% to 3.4% by weight. The percent oil removed from the sediment ranged from 30% for two-year old oiled sediment to 100% for freshly oiled sediment. The evaluation of the kiln was focused on oil removal efficiency and stack emissions rather than throughput rate. The feed rates used in this study do not reflect the maximum capacity of this device.*

## RÉSUMÉ

Un prototype en vraie grandeur d'un four à chambres alternantes, conçu pour éliminer par incinération les hydrocarbures de matériaux de plage (de la taille des graviers en descendant) a fait l'objet d'essais d'efficacité d'élimination et d'émissions de cheminée à l'aide de plusieurs types représentatifs de sédiments de plage et d'hydrocarbures.

Les sédiments de plage utilisés pour les tests comprenaient du gravier, du sable et un mélangeur 1:1 de sable et de gravier. Chaque échantillon est souillé à l'aide de pétrole brut et de Bunker "A" à l'état frais, altéré et émulsifié, à des charges d'hydrocarbures comprises en 0,05 et 3,4 % en poids. Le pourcentage d'hydrocarbures éliminé des sédiments était compris entre 30 % pour les sédiments souillés depuis 2 ans à 100 % pour les sédiments fraîchement souillés. L'évaluation du four portait principalement sur l'efficacité d'élimination et les émissions de cheminée plutôt que sur le débit traité. Les charges d'alimentation utilisées pour cette étude ne reflètent pas la capacité maximum de cet appareil.

## ACKNOWLEDGEMENTS

The author of this report was Ms. Chantal Gu nette. This project was performed under contract (Serial No. KE144-4-2141) to the Emergencies Engineering Division (EED) of Environment Canada by S.L. Ross Environmental Research Limited. Mr. Gary Sergy of the Emergencies Sciences Division (ESD), Ms. Monique Punt and Ms. Caroline Ladanowski of EED were the Scientific Authorities for this study. The Pollution Measurement Division of Environment Canada measured the concentration of the stack gas emissions and the Chemistry Division of Environment Canada performed the organic analysis of the particulate samples.

The work was funded by the Emergencies Engineering Division, the Technology Development Branch of Environment Canada, the Environmental Studies Research Fund, the Canadian Coast Guard and the Marine Spill Response Corporation (MSRC). The author would like to extend thanks to the following for their invaluable assistance during this study: Coast Guard Emergencies, Dartmouth, Nova Scotia and the Emergencies Engineering, Pollution Measurement, and Chemistry Divisions of Environment Canada, Ottawa.

## TABLE OF CONTENTS

|  | <u>PAGE</u> |
|--|-------------|
| 1.0 INTRODUCTION   | 1           |
| 1.1 Objectives   | 1           |
| 1.2 Goals  | 1           |
| 1.3 Report Contents                                      | 2           |
| <br>   |             |
| 2.0 BACKGROUND   | 3           |
| 2.1 Throughput Criteria                                  | 3           |
| 2.1.1 Basis  | 3           |
| 2.1.2 Rationale  | 3           |
| 2.2 Other Operational, Logistical and Safety Criteria    | 4           |
| 2.3 State-of-the-Art Review                              | 5           |
| 2.3.1 TRECAN Rotary Kiln                                 | 5           |
| 2.3.2 ROTRIN Incinerator                                 | 5           |
| 2.3.3 TRECAN Reciprocating Kiln and Modifications        | 9           |
| 2.3.4 Burn Barrel  | 14          |
| 2.3.5 Beach Burner                                       | 14          |
| 2.4 Comparison of Existing Concepts with Design Criteria | 16          |
| <br>   |             |
| 3.0 RECIPROCATING KILN PROTOTYPE DESIGN                  | 18          |
| 3.1 Design Objective                                     | 18          |
| 3.2 Design Improvements to Existing Kiln                 | 18          |
| 3.2.1 Combustion Air Flow                                | 19          |
| 3.2.2 Overall System Design and Drive Train              | 21          |
| 3.2.3 Fuel   | 21          |
| 3.2.4 Kiln Design  | 23          |
| 3.2.5 Kiln Construction                                  | 23          |



|   |  |    |
|---|--|----|
| 4.0   | TEST SITE, MATERIALS AND EQUIPMENT         | 24 |
| 4.1   | Test Site Location, Layout and Preparation | 24 |
| 4.2   | Test Materials                             | 26 |
| 4.2.1   | Test Oils                                  | 26 |
| 4.2.2   | Sediment and Preparation                   | 27 |
| 4.3   | Test Matrix                                | 28 |
| 4.4   | Test Methodology                           | 29 |
| 4.5   | Sample and Data Collection Methodology     | 29 |
| 4.5.1   | Sampling and Analysis                      | 29 |
| 4.5.2   | Data Collection                            | 30 |
| 5.0   | RESULTS AND DISCUSSION                     | 31 |
| 5.1   | On-site Modifications                      | 31 |
| 5.2   | General Observations                       | 31 |
| 5.3   | Operating Conditions                       | 36 |
| 5.4   | Oil Removal Efficiency                     | 38 |
| 5.5   | Stack Emissions                            | 41 |
| 6.0   | CONCLUSIONS AND RECOMMENDATIONS            | 43 |
| 6.1   | Conclusions                                | 43 |
| 6.2   | Recommendations                            | 44 |
| 7.0   | REFERENCES                                 | 45 |
| APPENDIX A: RECIPROCATING KILN USER'S GUIDE                   |  |    |
| APPENDIX B: BLUEPRINTS, EQUIPMENT LIST AND DRAFT CALCULATIONS |  |    |
| APPENDIX C: STACK EMISSIONS DATA                              |  |    |

## LIST OF FIGURES

| <u>FIGURE</u> |  | <u>PAGE</u> |
|---------------|--|-------------|
| 1             | Proposed TRECAN mobile incinerator for cleaning oiled sand     | 7           |
| 2             | ROTRIN road transportable incinerator                          | 8           |
| 3             | Original design of TRECAN reciprocating kiln                   | 10          |
| 4             | CCG modified reciprocating kiln (note use of culvert)          | 10          |
| 5             | Stainless steel reciprocating kiln                             | 12          |
| 6             | Heliportable reciprocating kiln built for the Nestucca cleanup | 13          |
| 7             | Beach burner general arrangement                               | 15          |
| 8             | Comparison of original combustion gas flow with the revision   | 20          |
| 9             | Revised reciprocating kiln general arrangement                 | 22          |
| 10            | Reciprocating kiln test site layout                            | 25          |
| 11            | Doors on culvert ends  | 32          |
| 12            | Kiln feed and discharge ends                                   | 33          |
| 13            | Reciprocating kiln in operation                                | 35          |
| 13            | Kiln firebox   | 37          |

## LIST OF TABLES

| <u>TABLE</u> |  | <u>PAGE</u> |
|--------------|--|-------------|
| 1            | Characteristics of kilns for cleaning oiled beach material | 6           |
| 2            | Comparison for oiled sediment                              | 17          |
| 3            | Initial properties of test oils                            | 26          |
| 4            | Reciprocating kiln test matrix                             | 28          |
| 5            | Summary of results from reciprocating kiln tests           | 40          |
| 6            | Summary of particulate emissions                           | 42          |

## **1.0 INTRODUCTION**

Over the last decade, several studies have investigated the use of combustion for cleaning oil contaminated beach material. However, few concepts have been studied in detail under controlled experimental conditions.

Spills such as those which occurred in Prince William Sound in 1989 and from the Nestucca on Canada's West coast have emphasized the importance of, and the problems associated with, shoreline clean-up. It was thus concluded that the concept of burning oil from contaminated beach material merited further research.

### **1.1 OBJECTIVES**

The objective of this study was to evaluate the concept of a shoreline burner, review existing technology and redesign the reciprocating kiln. The objective of the test program was to evaluate the efficiency of, and emissions from, a prototype reciprocating kiln for the removal of oil from contaminated beach sediment.

### **1.2 GOALS**

More specifically, the goals of the test program were:

- 1) to determine the steady-state throughput and oil removal efficiency of the reciprocating kiln as a function of sediment size, oil loading and oil type;
- 2) to determine the stack emissions emanating from the kiln during steady-state operations as a function of oil loading;
- 3) to determine PAH concentrations in the feed and stack emissions.

### 1.3 REPORT CONTENTS

Section 2 of this report describes the basis for sizing a reciprocating kiln and other design criteria; reviews the state-of-the-art in beach sediment combustion as a cleanup tool; and, compared the existing technology to the selected design criteria. Section 3 delineates the rationale and objectives of the kiln redesign process and describes the design improvements undertaken.

Section 4 discusses the site and methodology used to test the operation of the kiln and measure its emissions. Section 5 presents and discusses the results of the test program; general observations, measurements of oil removal efficiencies and smoke emissions data are presented. Section 6 contains the conclusions and recommendations arising from the study.

## 2.0 BACKGROUND

In order to produce a design for a device to burn oil from beach sediment it was necessary to define some criteria for its use.

### 2.1 THROUGHPUT CRITERIA

#### 2.1.1 Basis

One man can bag about 1 m<sup>3</sup>/day of oiled sediment or box about 2 m<sup>3</sup>/day (Pasquet 1981), thus a 10 man crew can generate between 10 and 20 m<sup>3</sup> of oiled sediment per day. Mechanized removal from sand beaches will generate up to 180 m<sup>3</sup> of oiled sand per machine on a daily basis. The oil content of manually removed sediment (5-10%) is generally much higher than that of mechanically removed sediment (1-2%) (Pasquet 1981).

#### 2.1.2 Rationale

A system to efficiently clean oiled beach sediment must be capable of being operated on or very near to the cleanup site since most of the oily material delivered to the combustor will not burn and is best returned to the shore of its origin, once cleaned. For manual beach cleaning operations this implies that the throughput of the device is constrained by the rate at which the material can be delivered. For a lightly or sporadically oiled beach of 2 km length 10-20 persons are required generating 10-20 m<sup>3</sup> of sediment daily. For the same beach heavily oiled 50-100 persons are required generating 50-100 m<sup>3</sup> of sediment daily. One combustion unit with a capacity of 2-4 tonnes per hour operating 10 hrs per day would be capable of supporting the cleanup in the former instance; two units of similar capacity operating 24 hours per day could support the latter. In the case of mechanized cleanup the generation rates of oiled sediment are so high (180 m<sup>3</sup>/day per earthmover) that it is unlikely that devices could be designed to burn the sediment clean and also be sufficiently portable. In this instance, it is recommended

that the oily sediment be stockpiled at a central location and cleaning be conducted there. It should be noted that a system to remove cleaned sediment from the area would also be required. A combustion unit with a capacity of 2-4 tonnes per hour could deal with 180 m<sup>3</sup> of oiled sediment in 3-7 days.

Thus, an oiled sediment burner/cleaner should have a capacity of 2-4 tonnes per hour. The unit should be capable of being manually loaded by shovel or with plastic bags of sediment and be capable of accepting sand, gravel and small (15 cm) cobbles. If external heat is required to clean the sediment, the unit should be able to accommodate a wide variety of field-available fuels (i.e., driftwood, fuel oils, etc.). The unit should also be heli-portable so that it can be moved to the sediment as well as vice-versa.

## **2.2 OTHER OPERATIONAL, LOGISTICAL AND SAFETY CRITERIA**

The following criteria apply to a combustion system for the disposal of oily material from spill cleanups:

- the unit must have a high turn-down ratio (i.e., large range of material flowrates over which the unit operates);
- any flame must be contained or controlled to reduce radiated heat levels to acceptable levels at operating positions ( $5 \text{ kJ/s m}^2 = 1500 \text{ BTU/hr ft}^2$ ) and to prevent ignition of surrounding structures/terrain;
- noise levels must be such that all that may be required is the use of simple hearing protection devices (i.e., ear plugs);
- smoke emissions should be minimal (maximum 40% opacity or Ringlemann #2);
- all components or ancillary support equipment should be heli-portable by a Bell 212 or equivalent (1000 kg) and capable of assembly in the field with simple tools by 2-3 personnel;
- any electric requirements should be 110/220 VAC to be supplied by common portable generators;
- all piping/hosing connections should be of the quick connect/disconnect type (i.e., Camlock) or adaptable to such;
- all prime movers, except small electrical generators, to be diesel powered;
- integral pumps, motors etc. to be of common manufacture for ease of repair and spare parts supply.

## **2.3 STATE-OF-THE-ART REVIEW**

Only one approach to the removal of oil from beach sediments by combustion has been commercially developed: the rotary kiln and its cousin, the reciprocating kiln. Table 1 lists the characteristics of the various kilns that have been proposed or developed. In addition, one interesting concept that has been taken to the prototype development stage (the beach burner) was included.

### **2.3.1 TRECAN Rotary Kiln**

The first system is the proposed TRECAN road transportable rotary kiln (Figure 1). The design of this device was based on extensive pilot-scale testing in a rotary kiln which revealed that the minimum oil content of sand for self sustaining combustion was 4.5% by weight and that a minimum 20 minutes residence time was required for complete oil removal (Meikle and Ewing 1980). A detailed design of the kiln was developed encompassing a unit measuring 14 m x 2.9 m x 3.5 m on a semi-trailer weighing 54,000 kg in total. The original design throughput was 8 tonnes/hr, however this was subsequently increased to 27 tonnes/hr based on sand with less than 11% oil, and 19 tonnes/hr for sand with 15% oil.

Economic and technical assessment of such a device was undertaken; the device was considered too expensive and not considered feasible and thus never built.

### **2.3.2 ROTRIN Incinerator**

The next device, the ROTRIN road transportable incinerator (Figure 2), was developed by Bennet Environmental Consultants to meet the needs identified by the TRECAN kiln studies (S.L. Ross 1985). This incinerator is designed to dispose of oily waste and hazardous materials. The device has a nominal capacity of 10 tonnes/hr of oiled sand or gravel containing 5-10% oil by weight and is mounted on two semi-trailers. Test results are not available for this device, although it is believed that several units have been sold internationally.

**TABLE 1**  
**Characteristics of kilns for cleaning oiled beach material**

| TYPE                                   | NOMINAL THROUGHPUT (tonnes/hr)  | SIZE (LxWxH) (m x m x m)   | WEIGHT (kg)                                      | TRANSPORT          | MATERIALS BURNED   | FUEL REQUIREMENTS   |
|--|---|--|--|--------------------|--|---|
| PROPOSED TRECAN MOBILE ROTARY KILN     | 19 with 15% oil, 27 with sediment with less than 11% oil                    | 14 x 2.9 x 3.5   | 54,000   | 1 semi-trailer     | oiled sand   | 75 hp diesel and up to 450 L/h burner fuel to bring oil content to 4.5% by weight |
| ROTRIN                                 | 10 (5 to 10% oil in sand or gravel)   | not available (2 semi-trailers)  | not available                                    | 2 semi-trailers    | oiled sand and gravel  | 75 L/h propane and 19 L/h diesel  |
| RECIPROCATING KILN (latest SS version) | 1.8 (5 to 20% oil)  | Kiln & stack 5.8x0.8x1.4 housing 1.5 x 1 x 3.4 engine                      | 427 (culvert model weighs 927 1364)<br>460<br>40 | heli-portable      | oiled sand, used drill mud and oiled gravel                          | prime mover (tractor or small diesel) plus underfire oil etc. (if required)       |
| BURN BARREL                            | 0.05  | 45 gallon drum   | 10   | n/a                | oiled gravel   | 75 kg/hr of propane   |
| BEACH BURNER PROPOSED PROTOTYPE        | 250 m <sup>2</sup> of beach/hr (equivalent to 12 tonnes/hr manual clean-up) | prime mover 3.3x0.98x2.1 firebox 3 x 1.2 x 1.6 support trailer 1.8x1.8x1.4 | 1350<br>250<br>unknown                           | 2 helicopter lifts | oiled sand, gravel in-situ to depth of 1 to 2 cm with 75% efficiency | 150 L/hr diesel   |



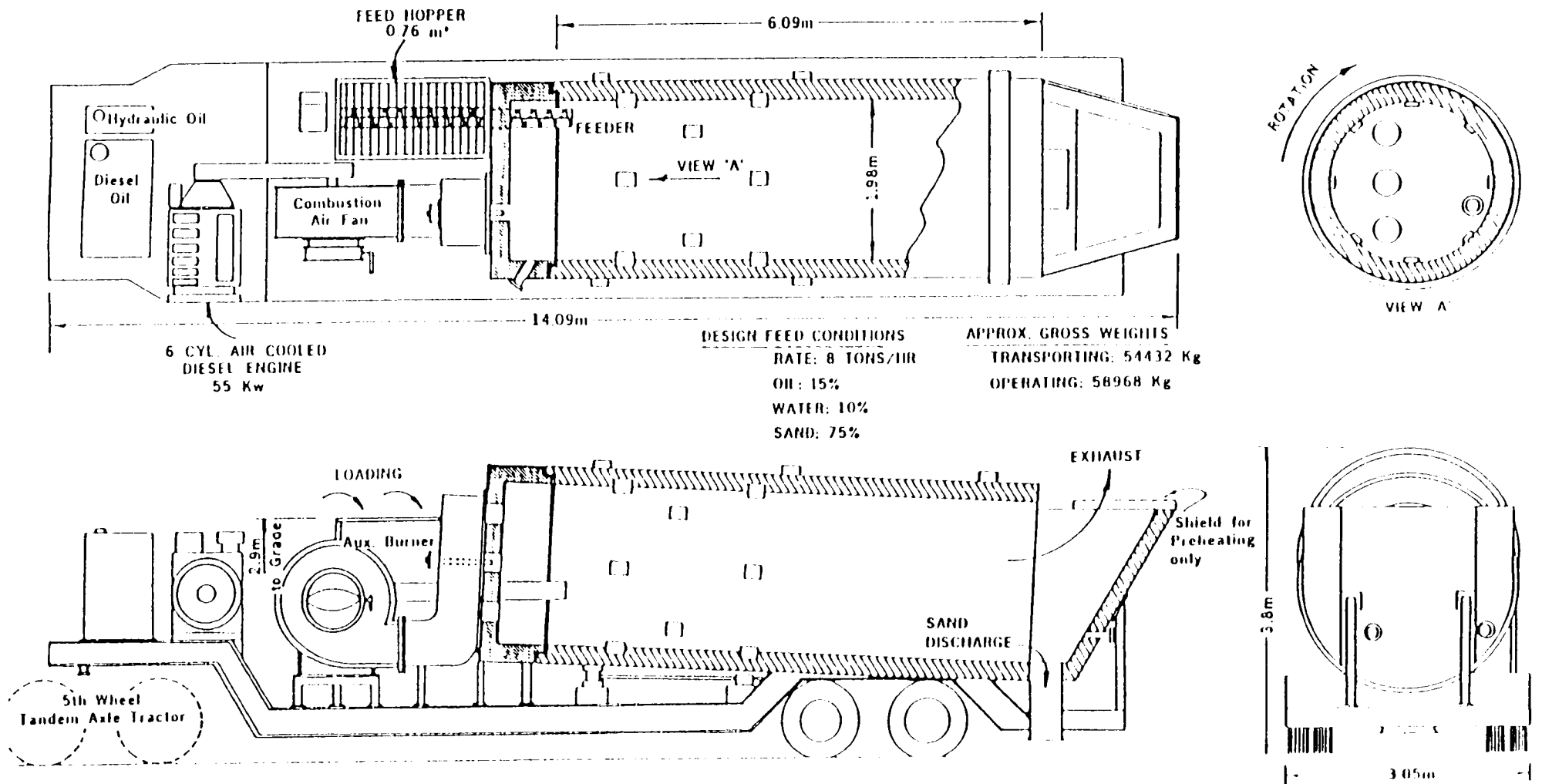

FIGURE 1 Proposed TRECAN mobile Incinerator for cleaning oiled sand

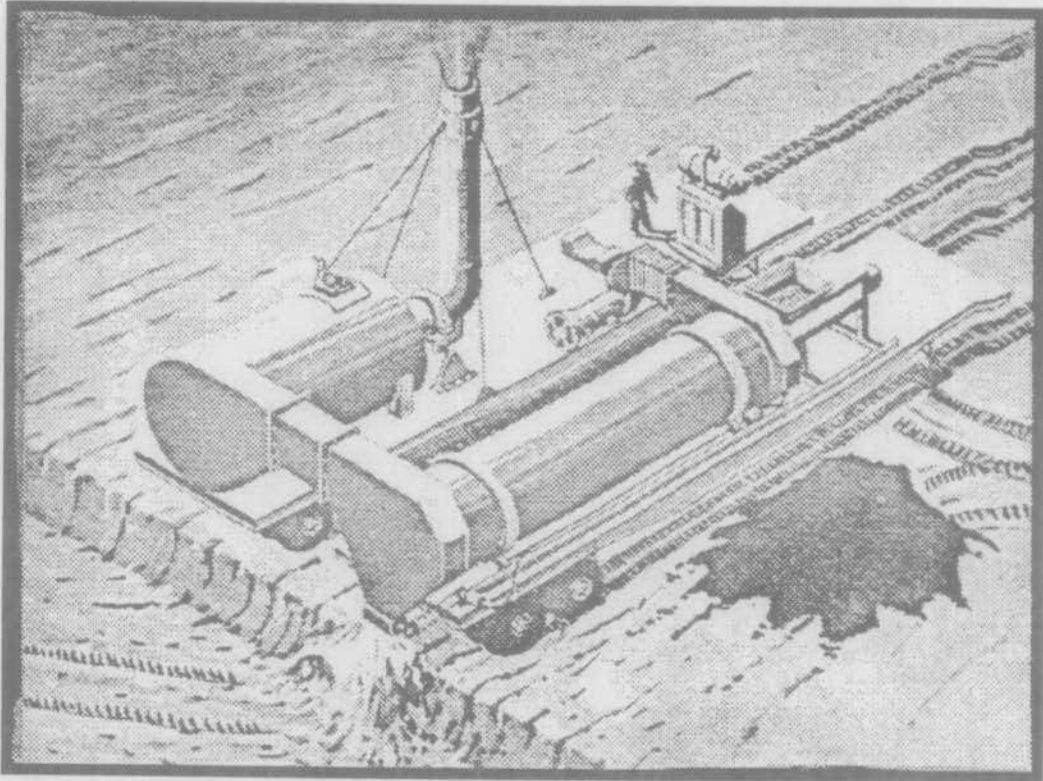

Figure 2: ROTRIN road transportable reciprocating kiln

### 2.3.3 TRECAN Reciprocating Kiln and Modifications

The reciprocating kiln, devised by TRECAN for the Petroleum Association for the Conservation of the Environment (PACE) and Environment Canada, is a simple kiln for processing 1-2 tonnes/hr of oiled sand or gravel (Meikle and Ewing 1979). The original design (Figure 3) called for the use of 45 gallon drums, used auto parts and a small farm tractor as prime mover. This design was field tested and successfully cleaned 1.8 tonnes/hr of oiled sand with an oil content of 5%; 0.8 tonnes per hour with an oil content of 10%; and, 0.6 tonnes per hour with an oil content of 20%. Residence times ranged from 3.5 to 5 minutes. The device included a simple firebox in which wood was burned to provide heat for warmup and to aid in the cleaning of sediment with less than 5% oil. Heavy smoke was emitted in puffs during the unit's operation and the average stack gas temperatures were 425° to 650°C (800° to 1200°F) with the maximum being 1100°C (2000°F).

Over the last decade, several modifications have been made to the original reciprocating kiln design. These are described below.

a) Canadian Coast Guard modifications:

The first modification to the device was undertaken by the Coast Guard (Gill and Stevens 1980) during the Kurdistan cleanup (Figure 4). Steel culvert was used in place of the drums for the kiln (the drums lasted only 40 hours and the thin metal cooled too quickly), the position of the stacks was moved to the top of the firebox (to improve kiln heating) and the internal baffle system was modified. Over an extended period of operation the fuel consumption was found to be 1/3 of a cord of driftwood per hour (equivalent to about 250 L/h of diesel) for lightly oiled cobble. The fuel consumption dropped when the oil content of the material increased. At the operation's peak, about 350 garbage bags of oiled gravel were processed per hour (6 tonnes per hour).

b) Environment Canada:

The next modification was undertaken by Environment Canada (Meikle and Ewing 1980) to make the unit heli-portable. This involved utilizing a small diesel engine to replace the tractor as prime mover and packaging the various sub-assemblies for heli-transport (two lifts totalling 1364 kg).

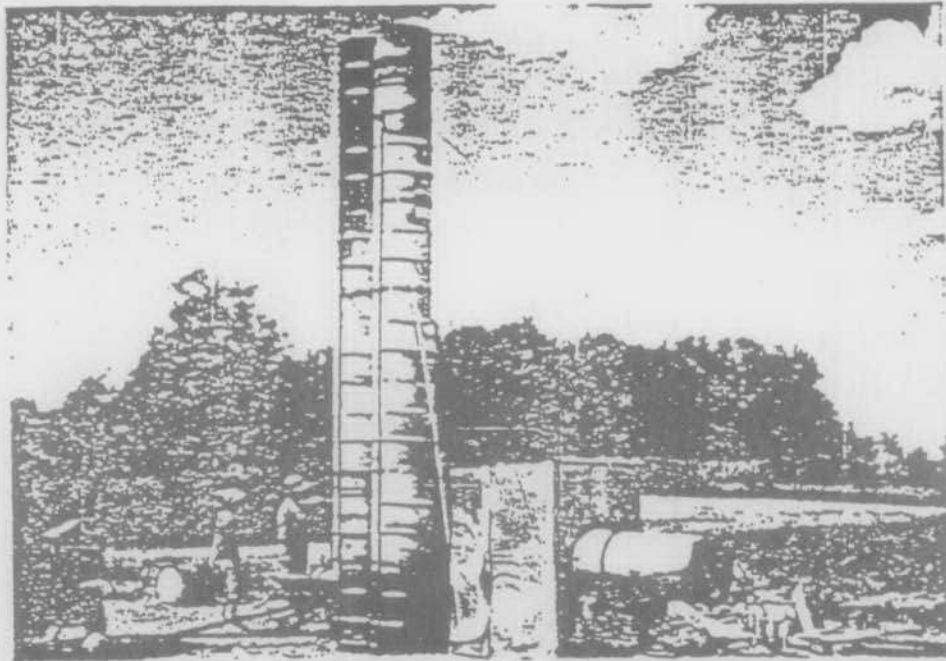

FIGURE 3 Original design of TRECAN reciprocating kiln

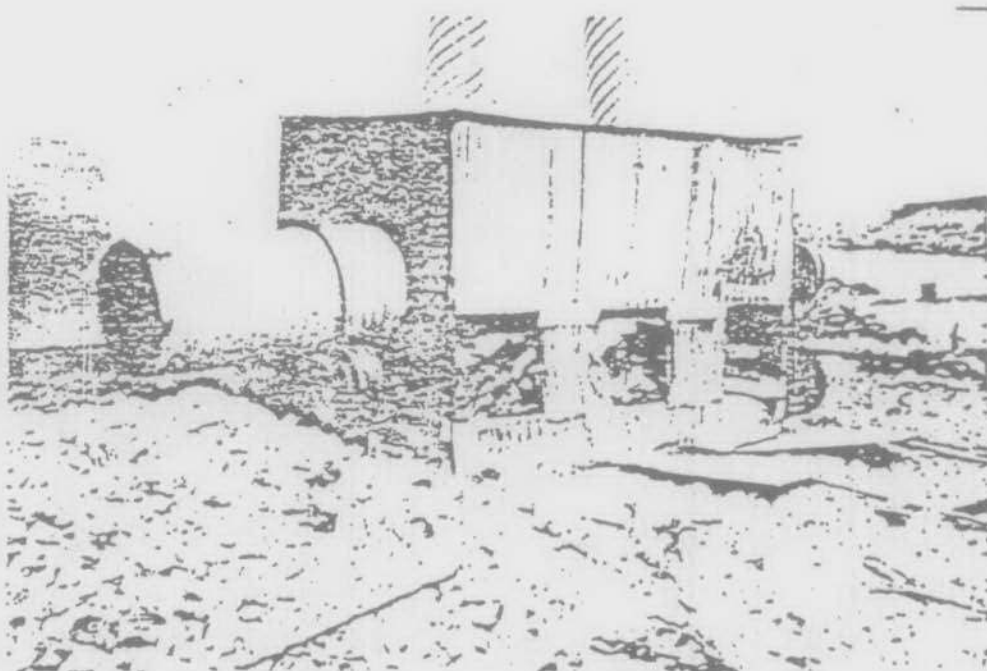

FIGURE 4 CCG modified reciprocating kiln (note use of culvert)

c) Energetex Engineering:

The most recent modification is a stainless steel version (Swiss et al. 1985) produced by Energetex Engineering for the Beaufort Sea Co-op (Figure 5). The use of stainless steel considerably reduced the weight of the unit (to 927 kg) and considerably extended its design operational life. The prime mover is a small diesel engine and pans were included for the burning of liquid fuels in the firebox to expand the types of fuel that could be used to fire the unit. Rates of 0.9 tonnes/hr of oiled soil have been achieved during tests with this kiln version. The baffling in the firebox warped during these tests, permitting combustion gases to escape directly up the stack rather than circulating around the kiln first. This reduced the unit's throughput measured during the tests.

Most recently, an early version of the reciprocating kiln (the heli-portable design discussed above), powered hydraulically, was constructed for cleaning oiled pebbles and cobbles at a beach oiled by the Nestucca spill in January 1989 (Figure 6). The kiln, fired by locally collected driftwood and slash, was set up near Bajo Point; however, it proved inefficient in removing oil from the gravel and cobble (CCG 1989). The reasons for this include:

- very low percentage of oil on the beach material (the beach had been cleaned once prior to the set-up of the kiln and was reportedly continuing to self-clean under the influence of wave-action);
- excessively high draft through the stacks (the port from the firebox to the kiln was too large as built and had to be field modified to reduce excessive draught) reducing heat transfer from the underfire to the kiln;
- heavily weathered oil residue on the beach material (i.e., very high flash/fire point).

It should be noted that some cobble was successfully cleaned using a 10 minute static preheat followed by a 5 minute rotational burning period. The estimated throughput was 50-100 kg/hr. It should be further noted that a static preheat is not recommended as warping and subsequent binding can occur with the kiln.

Suggested improvements to this design included: thicker steel plate for the fire box doors and internal baffles to reduce heat-induced warping; the provision of sliding doors above and below the baffle at the entrance port to the stack for better draft control; and, modification to the entrance and exit to the kiln to permit sealing during heat-up.

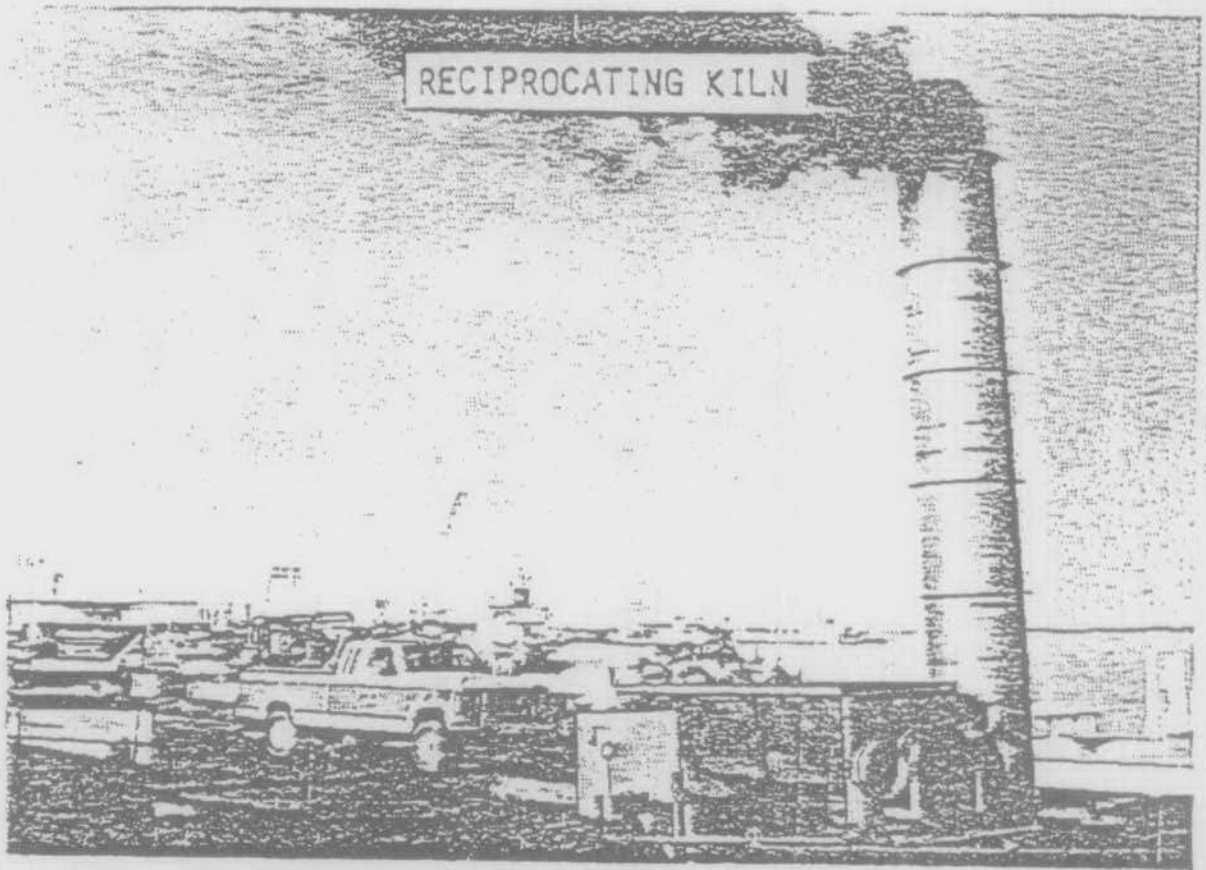

Figure 5 - Stainless steel reciprocating kiln

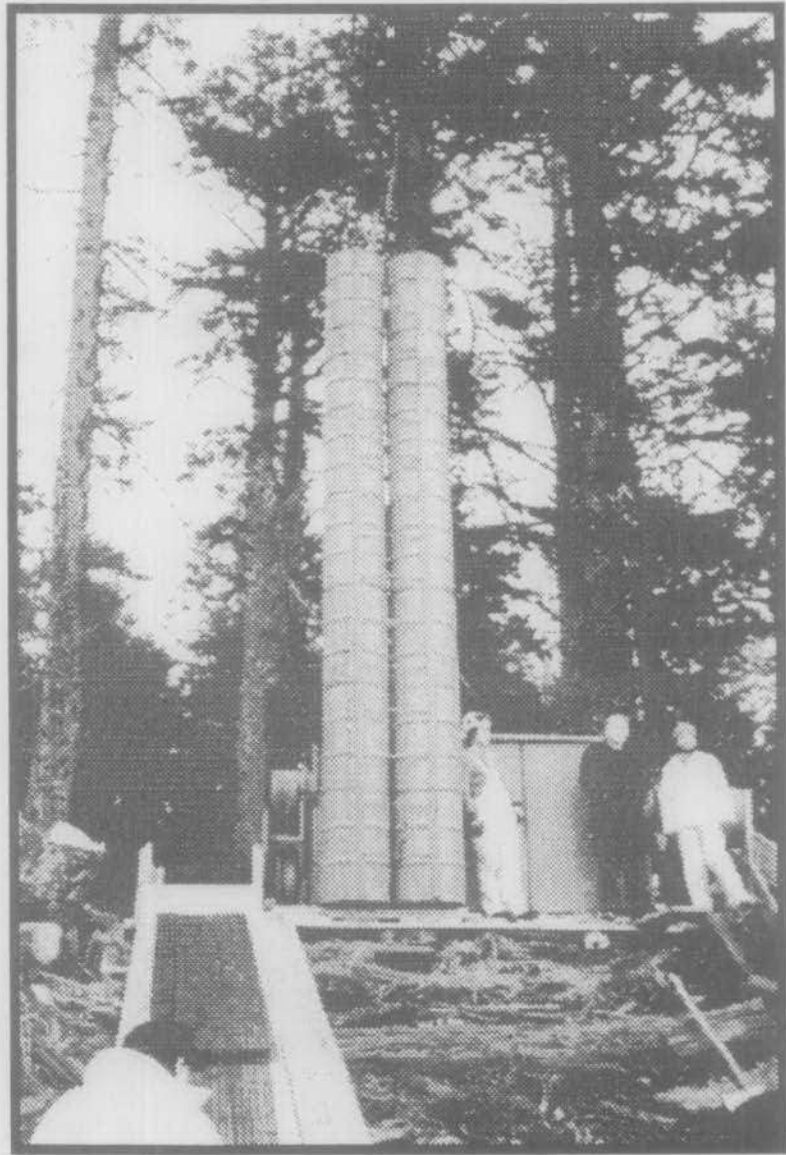

Figure 6: Heliportable Reciprocating Kiln built for the Nestucca cleanup

#### 2.3.4 Burn barrel

The final proven system for cleaning oiled beach sediment is the use of a 45 gallon drum holed in the bottom and with a grate installed about 2/3 of the way down the barrel (Bayliss and Spoltman 1981). A propane weed burner is played over the drum to burn off oil and debris. Throughput of 0.05 tonnes/hr (50 kg/hr) of 5% oiled gravel and debris have been achieved with a 7 kg/hr consumption of propane. To achieve a 1 tonne per hour capacity 20 drums would be required and propane consumption would be 140 kg/hr (equivalent to about 125 L of diesel).

#### 2.3.5 Beach burner

The proposed Beach burner (Figure 7) is included because, though unproven, it offers the possibility of cleaning oil from beaches in-situ thus eliminating costly and time consuming pick-up, transportation and replacement costs (Bennett et al. 1987). The system, as envisioned, would be composed of a prime mover (small excavator), holding a diesel-fired, open-bottomed firebox beside it and towing a trailer carrying a blower, fuel and generator. Small-scale tests showed that the concept works best with a wide range of oils or emulsion on hard-packed, wet sand or sandy gravel (95% removal); removal efficiencies were optimum at advance rates of 82 m/hr or less under these conditions. Removal efficiencies decreased rapidly for larger sediments with removal efficiencies of 50% or less for drained gravel sediments with less than 50% sand. Heat penetration into sediments was minimal.

The proposed unit would be heli-portable in two lifts (exclusive of fuel), cover 250 m<sup>2</sup>/hr (based on a 1 mm oil layer thickness) at a forward velocity of 82 m/h and operate at a rate equivalent to 11 tonne/hr manual removal operations. Diesel fuel consumption for the burners would be on the order of 150 L/hr. With further developments and testing, this type of equipment could prove cost effective for cleaning recreational or amenity sand or sand/gravel beaches. The system does not seem feasible for the cleaning of pebble, gravel or cobble beaches.



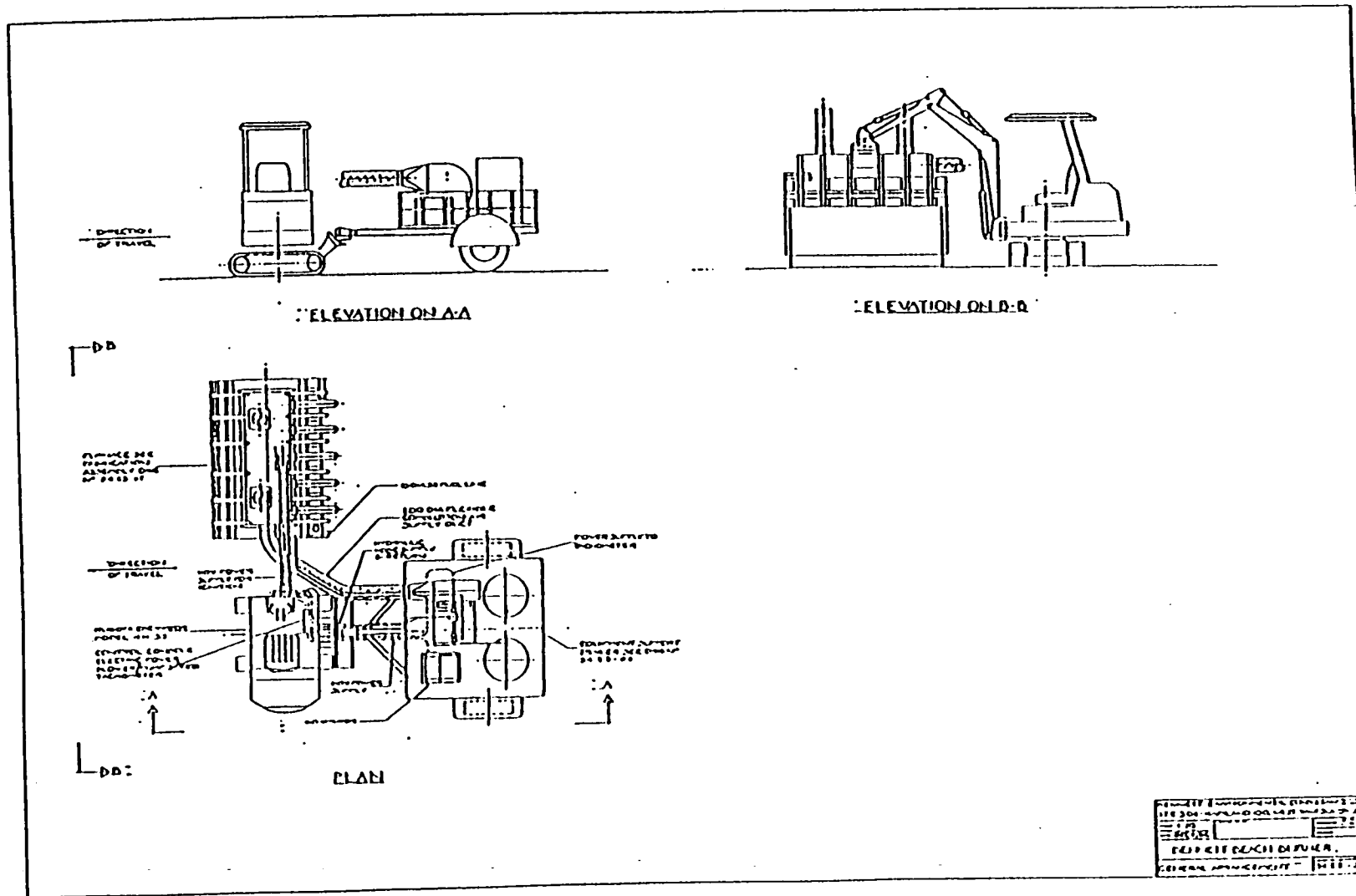

Figure 7 Beach Burner general arrangement.

## **2.4 COMPARISON OF EXISTING CONCEPTS WITH DESIGN CRITERIA**

Table 2 compares the design criteria with the capabilities of existing/proposed sediment combustion systems. The TRECAN reciprocating kiln is recommended as the most suitable oiled sediment cleaning system. Although somewhat low in capacity (1-2 tonnes per hour) compared to the criteria of 2-4 tonnes per hour the device is considered more suited to its role than larger capacity units which have severely restricted access to many beaches. The reciprocating kiln has also proven capable of cleaning a wide range of sediments (sand to 15 cm cobbles) with varying oil content (low-20%) and can be relatively quickly constructed of widely-available materials-of-opportunity.

**TABLE 2**  
**Comparison for oiled sediment**

| KEY CHARACTERISTICS            | CRITERIA                   | TRECAN MOBILE KILN | ROTRIN              | RECIPROCATING KILN  | BURN BARREL | BEACH BURNER                               |
|--------------------------------|----------------------------|--------------------|---------------------|---------------------|-------------|--|
| Throughput                     | 2 to 4 tonnes/hr           | 19                 | 10                  | 1.8                 | 0.05        | 12   |
| Weight                         | units of 1000 kg           | no                 | no                  | yes, in three units | yes         | close (one of three units exceeds 1000 kg) |
| Size                           | loadable by hand           | no                 | no                  | yes                 | yes         | unnecessary                                |
| Transport                      | medium duty helicopter     | no                 | no                  | yes                 | yes         | yes  |
| Combustion Material Properties | sediment with 1 to 20% OIL | yes                | unknown, but likely | yes                 | yes         | yes, for sand beaches only                 |

### **3.0 PROTOTYPE RECIPROCATING KILN DESIGN**

This section describes the design process undertaken to revise the reciprocating kiln to meet the specific criteria.

#### **3.1 DESIGN OBJECTIVE**

The objective of the design was to produce a device capable of cleaning 1 to 4 tonnes per hour of oil-contaminated sand and/or gravel. The unit was to be heliportable, operable in a stationary mode and of minimum cost. The design also called for rapid construction of units at local facilities.

#### **3.2 DESIGN IMPROVEMENTS TO EXISTING KILN**

Rather than start from scratch, the approach taken was to improve the existing heli-portable kiln design (Meikle & Ewing 1980). In order to improve the capability of the existing kiln design in handling oiled gravel material, improve its operational life, increase its oil removal efficiency and reduce its weight and complexity, a preliminary analysis of the combustion process in the kiln was undertaken. The redesign goal was to optimize the existing design to maximize throughput and heat transfer to oiled sediment from combustion gases fuel while maintaining simplicity of design, operation and construction within the heli-portability constraint.

Since a modification of the original reciprocating kiln had operated successfully at the Kurdistan spill (Gillart & Stevens 1980) on the target sediments at reasonable throughput the first question to be answered was why did it not work on the Nestucca spill. In comparing the successful use at the Kurdistan spill with the unsuccessful tests at the Nestucca spill several differences were apparent:

- 1) the weight percent of oil in the sediment (unknown but probably considerably higher at the Kurdistan site);
- 2) the airflow through the kiln (low at Kurdistan; high at Nestucca);

- 3) materials of kiln construction (thick steel culvert at Kurdistan; used drums at Nestucca);
- 4) stack location and combustion gas flow path.

### 3.2.1 Combustion Air Flow

By optimizing the combustion gas flowrates, gas temperatures are increased and heat transfer in the kiln optimized. Two options for providing the combustion air flow were considered: induced draft and natural draft.

The advantages of induced draft are: better control of air and gas flows and the ability to add emissions control devices; the disadvantages are increased weight, power, complexity, maintenance and cost (the fan must be built to withstand up to 1100°C temperatures). The advantages of natural draft are that it is simple, low weight and low cost; the disadvantages are less control and the inability to add emissions control equipment (other than an afterburner).

Draft requirement calculations were performed and can be found in Appendix A. In light of these calculations, and the simplicity of natural draft vs. the complexity and cost of induced draft, a redesigned natural-draft stack was selected. The single stack design chosen would induce only one half the air flow of the original TRECAN design (which reportedly drew too much air) and about twice that of the design used at the Kurdistan (which was too little for the combustion rates required to clean the oiled cobbles).

Figure 8 compares the original combustion gas flow path with the proposed revision. In the revised design, the combustion gases from the kiln travel around more of the circumference of the kiln before exiting (better heat transfer). The redesigned baffle, hanging against the side of the kiln rather than butting up against it should offer a better seal; this baffle is hinged to allow improved gas flow around the kiln during preheating or the cleaning of very low oil content sediment. A damper was included in the revised stack design for better control of gas flow during preheating and operating periods.

As well, in order to improve the supply of preheated combustion air to the kiln, the slot in the kiln itself was shortened to cover only the first 2/3 of the kiln, allowing air to be drawn in from the outlet end of the kiln.

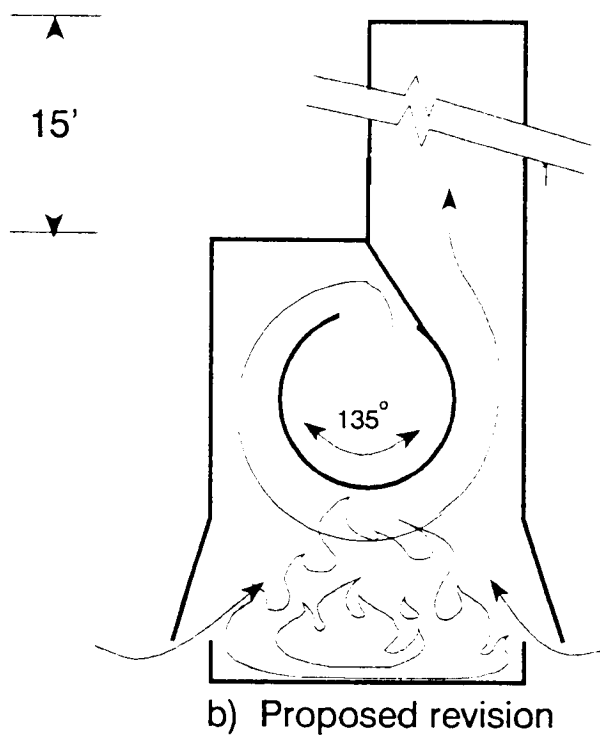
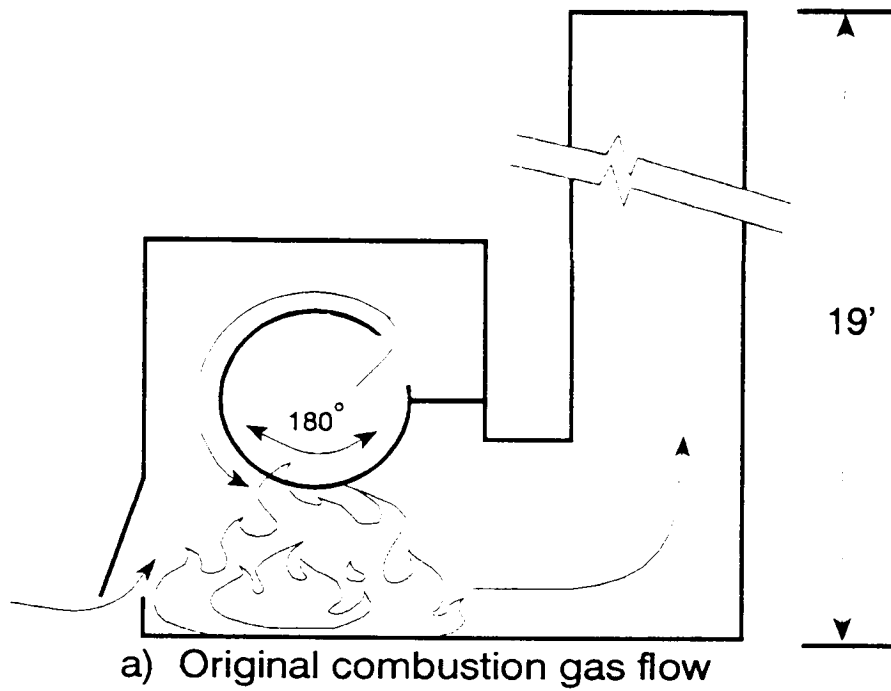

Figure 8: Comparison of original combustion gas flow with the revision

### 3.2.2 Overall System Design and Drive Train

It was proposed that the overall size, layout and drive system for the kiln be left as is, since it had proved capable of cleaning the target sediments at the desired rates. The exception was the location of the stack which was proposed to be mounted on top of the firebox (Figure 9) to reduce weight and improve gas flow; this also allowed unimpeded access to the underfire area from both sides of the kiln.

The kiln itself was redesigned with heavier gauge steel than drums to improve heat capacity and impact resistance; culvert and custom-rolled sheet were investigated. Standard thickness culvert was chosen due to its ready availability and low price. In addition, thicker metal was to be used for warp-sensitive portions of the kiln (firebox doors, baffle, draft door, etc.).

### 3.2.3 Fuel

The design and layout of the original kiln was based on using wood (driftwood, cordwood, etc.) as the underfire fuel for preheating or during the processing of low-oil-content sediments. The original design also called for wicking trays for the underfire if sufficient wood was not available for underfire fuel. About 250 L/hr of diesel or #2 fuel oil would have to be burned to equal the estimated 1/3 cord of wood per hour used to clean the gravel/cobble sediment at the Kurdistan spill. Consideration was given to propane as an auxiliary fuel but this was rejected because it has only 65% of the heating value of liquid fuels per unit volume, involves a pressurized gas and may not be readily available in the Arctic.

An auxiliary fuel addition was also proposed, primarily for low oil content sediment. Several options were investigated, including auxiliary burners; however, it seems easiest to simply spray #2 fuel oil or diesel directly onto the sediment in the inlet section of the kiln; the fuel will burn and its presence prior to ignition may soften or loosen weathered oil, particularly under the influence of the rocking action of the kiln.

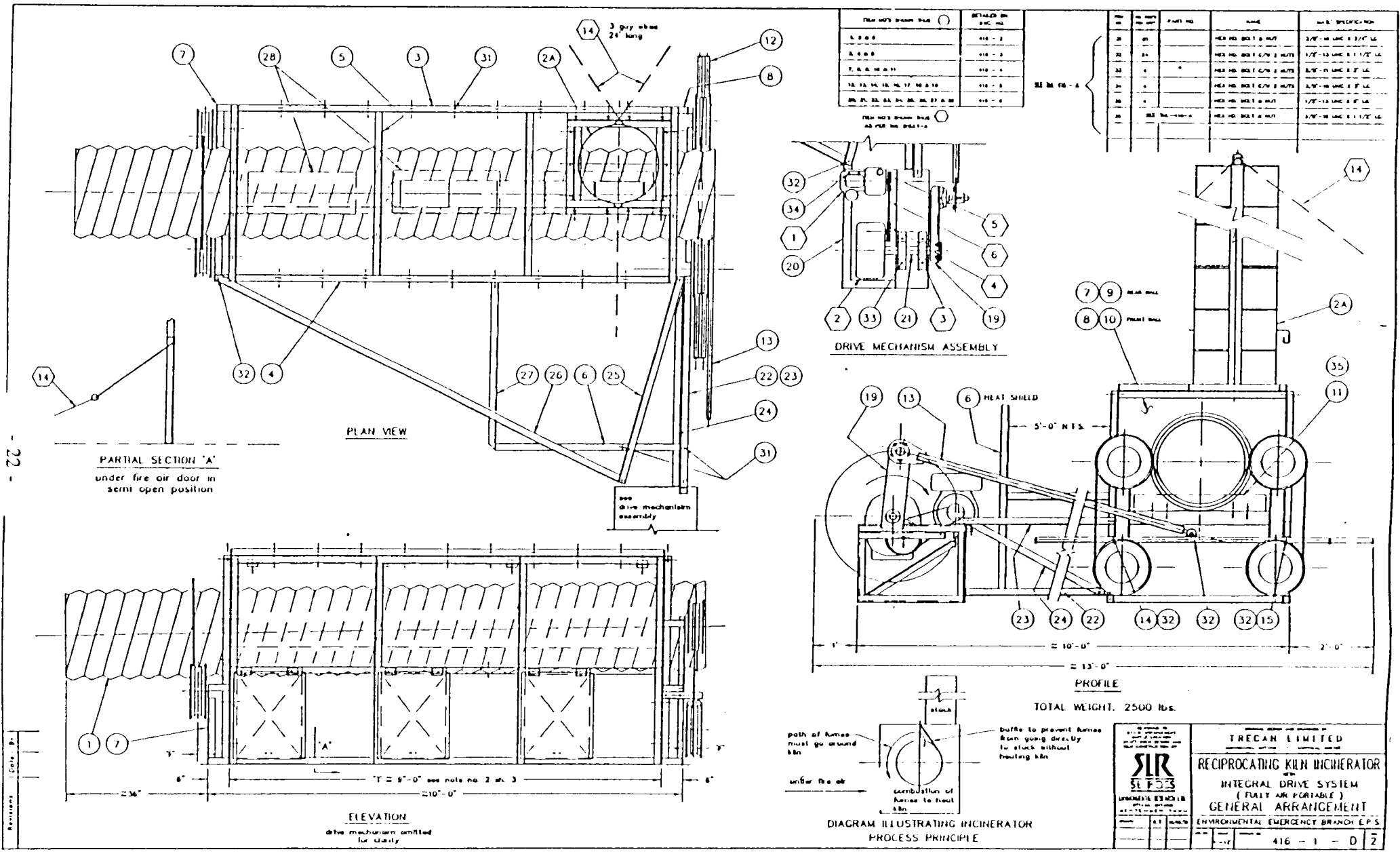

Figure 9: Revised reciprocating kiln general arrangement



#### 3.2.4 Kiln Design

Figure 9 shows the general layout of the revised kiln design. Letter-sized reproductions of the full blueprints may be found in Appendix A; full-size blueprints and/or AUTOCAD 386 version 10 diskettes are available from the Emergencies Engineering Division of Environment Canada.

#### 3.2.5 Kiln Construction

The kiln was constructed in 1991 at a machine shop near Ottawa. From order placement to delivery of the kiln required about 2 to 3 weeks. It is believed that construction time for subsequent units would be much less than this. The cost of this kiln was approximately \$27,000 of which \$7,000 was for the diesel and speed reducer and approximately \$5,000 was for overtime charges due to a rush order.

## 4.0 TEST SITE, MATERIALS AND EQUIPMENT

### 4.1 TEST SITE LOCATION, LAYOUT AND PREPARATION

The trials were conducted at the Chebucto Head Lighthouse near Halifax, Nova Scotia. Figure 10 shows the test site layout. This test site had the following required characteristics (primarily for emissions sampling equipment):

- accessible by step van with trailer
- electric power - one 220V/50A circuit
- a level, cement pad

The kiln was erected on a pad of sand measuring 4 m x 2 m x 20 cm deep. This pad served several purposes, including:

- protecting the underlying cement foundation from the underfire heat,
- reducing vibration of the kiln and drive system components,
- preventing any unwanted drips from the kiln reaching the underlying cement foundation,
- providing an air seal around the bottom of the kiln box,
- providing a means of leveling the kiln and engine module

The week prior to the tests, the kiln was erected on the pad and dry run. Scaffolding and heat shielding for the emissions sampling were erected. A box was constructed to hold the oiled sediment at the feed end of the kiln. A chute at the discharge end of the kiln was constructed to collect the cleaned sediment.

In order to eliminate the risk of accidental spills onto the ground, all oil storage was placed inside plastic-lined berms capable of containing 110% of the aggregate volume of the oil stored. The sand pad upon which the kiln sat was underlain with a plastic tarp to prevent any spillage from entering the soil. As well, the sediment stockpiles and mixer were placed on plastic tarps.

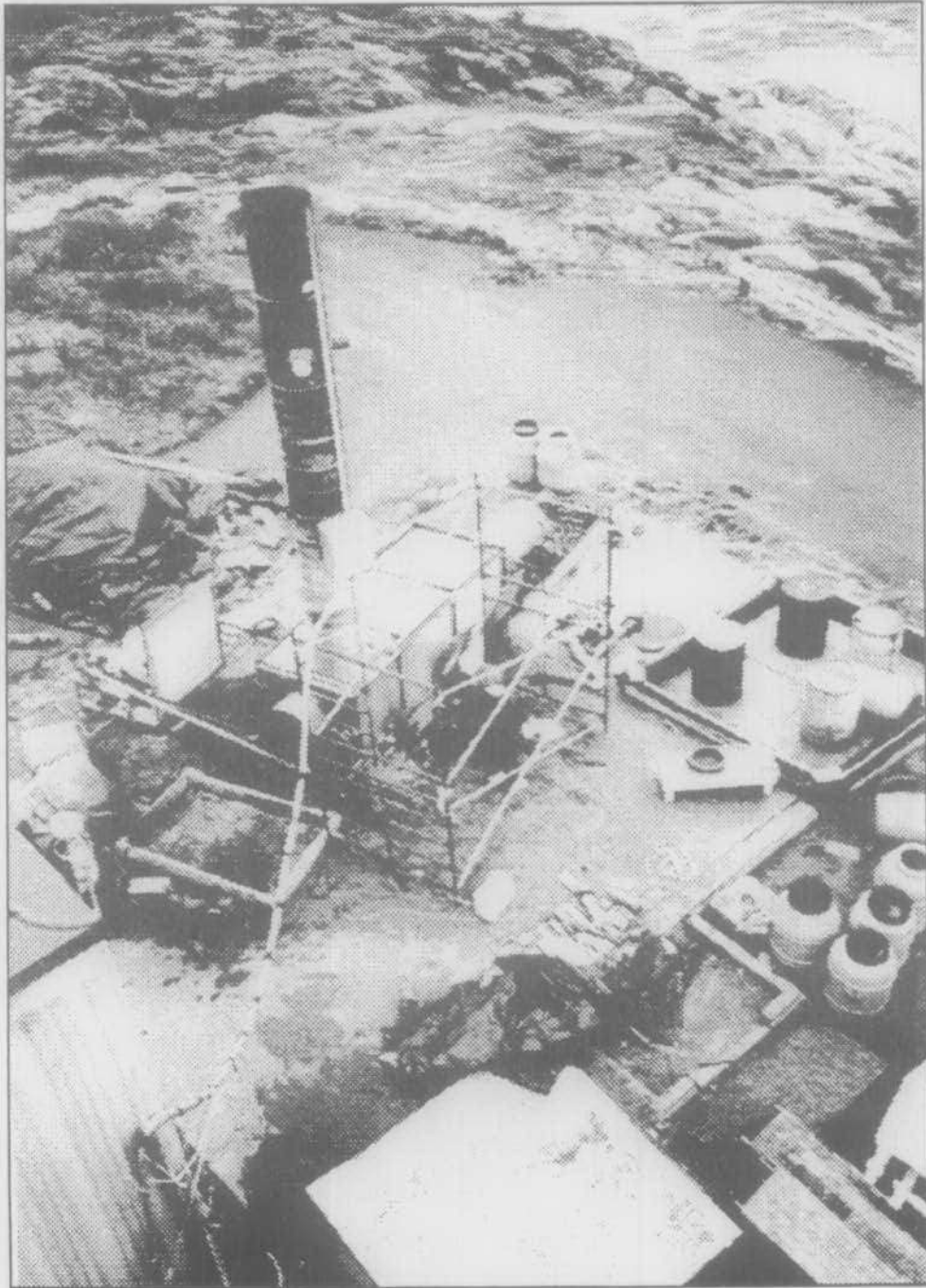

Figure 10: Test site layout

A fire extinguisher was available on site to extinguish accidental fires. Neighbouring homeowners were advised of the test program prior to its commencement; the local fire department was advised on a daily basis of planned burns.

## 4.2 TEST MATERIALS

### 4.2.1 Test Oils

Two test oils were used in this study, an Ontario light crude oil and Bunker "A". Crude oil termed "fresh crude" in the test matrix, was lightly weathered by air sparging, to approximately 10% evaporative loss. The "weathered" oil was prepared by spraying fresh crude on the test sediment and allowing it to weather, outdoors for a period of six weeks in 1991. This sediment was subsequently placed in plastic, 200 L drums and stored outdoors until the 1992 tests. The "emulsified" oil was created by mixing 25% crude oil with 75% water (by weight) in a bucket using a paint mixer.

The following table lists the properties of the oils used in this study.

**TABLE 2**  
**Initial Properties of Test Oils**

| Test Oil            | Viscosity (m.Pas) @ 23.4°C | Density (kg/m <sup>3</sup> ) @ 21.8°C |
|---------------------|----------------------------|---------------------------------------|
| "fresh" crude       | 10 *                       | 834 *                                 |
| emulsified crude #1 | N.A.                       | N.A.                                  |
| Bunker A            | 96 *                       | 920 *                                 |

N.A. = not analysed

\* S.L. Ross 1990

#### 4.2.2 Sediment

Two types of sediment were used to test the kiln: a medium sand (approximately 0.5 mm grain size) and a coarse gravel (approximately 50 mm stone size). A 1:1 mixture of the two sediment was also used for certain tests. The test sediment was obtained from a quarry located near Ottawa.

The test sediment was prepared as follows:

- sediment oiled with Bunker A, fresh and emulsified crude. This was prepared by mixing known weights of sediment and oil in a 6 ft<sup>3</sup> portable cement mixer until all the sediment was thoroughly coated with oil.
- sediment oiled with weathered crude. Six weeks prior to the initially scheduled testing (summer of 1990), six test plots had been prepared for weathering oiled sediment. Each plot consisted of a 2 m<sup>2</sup> enclosure constructed of 2" x 6" lumber (on side) lined with 6 mil plastic sheeting into which ½ m<sup>3</sup> of sediment was evenly spread (two with sand, two with gravel and two with a 50% mixture of sand and gravel); appropriate amounts of "fresh" crude oil was sprayed onto each plot using a "backpack" sprayer. Because of delays in testing due to difficulties in obtaining permission for the 1990 program, this sediment was stored in barrels for approximately one year then transported to the test site, near Halifax.

### 4.3 TEST MATRIX

The following was the test matrix for the program.

**TABLE 4**  
**Reciprocating Kiln Test Matrix**

| Rock Size<br>(mm)                      | Oil Type         | Oil Loading<br>(wt %) |
|--|------------------|-----------------------|
| 0.5                                    | "fresh" crude    | 2.5                   |
|  | weathered crude  | 5.0<br>2.5            |
|  | emulsified crude | 2.5                   |
|  | Bunker "C"       | 2.5                   |
| 50                                     | "fresh" crude    | 2.0                   |
|  | weathered crude  | 0.5                   |
| mixture (50 wt%<br>each of 0.5 and 50) | "fresh" crude    | 2.5                   |
|  | weathered crude  | 1.0                   |
|  | Bunker "C"       | 2.5                   |

Although originally 24 runs had been planned, due to time and weather-induced constraints only ten runs were attempted, nine of which successfully. It should be noted that the oil loadings indicated in the above Table 3 were targets. The actual oil loadings are given in the results section.

#### 4.4 TEST METHODOLOGY

1. Approximately ½ tonne of the first sediment/oil combination was prepared in the 6 ft<sup>3</sup> portable concrete mixer and placed in the lined box at the feed end of the kiln.
2. The kiln was started and heated up using underfire fuel.
3. Once the kiln was preheated sufficiently (a dry stick began to smoke and char immediately after being thrown into the kiln) the sediment was manually shovelled into the kiln. Over the first 10-15 minutes of each test the kiln was adjusted (i.e., rate of reciprocation, damper position, additional fuel, etc.) to provide maximum oil removal and then run for the remaining time at the selected conditions.
4. Once steady-state was reached, sediment samples were taken.
5. During the test, the cleaned sediment was removed from the discharge end of the kiln using a BOBCAT front end loader and returned to the back of the appropriate stockpile for cooling and reuse on subsequent days.
6. The next sediment/oil combination was prepared and placed at the feed end of the kiln.
7. Steps 3 through 6 were repeated for the next sediment/oil combinations.
8. On completion of the day's test the kiln was allowed to cool while running for approximately half an hour and then shut down. The draft doors were opened at this time to accelerate the cooldown of the kiln.
9. On the final two days of testing 3 x four hour runs were conducted in order to obtain longer test times for particulate and PAH emissions sampling.

#### 4.5 SAMPLE AND DATA COLLECTION METHODOLOGY

##### 4.5.1 Sampling and Analysis

For each test, the following samples were taken:

##### Prior to Test

- 1) sample of oil used on the sediment, for viscosity and density analysis

- 2) sample of feed sediment for oil concentration analysis by solvent extraction

#### During Steady-State Operation

- 3) sample of output sediment for oil concentration analysis by solvent extraction
- 4) particulate emissions (long term sampling)
- 5) polycyclic aromatic hydrocarbons (PAHs) emissions (long term sampling)

The collected samples were returned to the appropriate Environment Canada laboratories for analysis. The oil and sediment samples were collected and analysed by EED. The emission samples were collected by PMD and analysed by CD.

#### **4.5.2 Data Collection**

For each test, during steady-state operations, the following was measured and recorded:

- weight of sediment used (20 L bucketfulls weighed on a scale)
- weight of oil added to the sediment
- underfire feed rate (recorded number of 18"x6" diameter logs put on the underfire during a run)
- rate of kiln reciprocation (timed with a stopwatch)
- sediment feed rate (recorded length of time to feed all sediment into kiln)
- sediment residence time (time for a coin to travel through kiln)
- draft door settings
- stack gas temperature (PMD equipment).
- stack gas emissions (continuous monitoring by PMD)
- stack emission opacity (visually estimated using the Ringlemann Scale and a Smoke Density Chart as provided by the Air Pollution Control Service of the Ontario Department of Health. These visual observations were not, however made by a certified observer).



## **5.0 RESULTS AND DISCUSSION**

### **5.1 ON-SITE MODIFICATIONS**

In order to secure the stack, it was necessary to cut holes in the firebox roof support angle iron for the stack to allow access for a wrench to hold the nuts.

It was found that the fire was difficult to start when the firewood was placed directly on the sand inside the firebox, particularly if the sand was wet. Therefore, a metal grill, supported by a dozen cinder blocks, was placed inside the firebox in order to provide better air circulation beneath the fire. This proved effective, greatly reducing the time required for start-up.

A blower, attached to a 10 cm diameter steel pipe was placed inside the firebox near the output end of the kiln. The pipe, attached to the blower was then placed beneath the grill to enhance the airflow to the fire. This proved to be quite effective, although the only means of control was to either turn the blower on or off. A diffuser of some sort may have provided a better distribution of air flow to the underfire. The blower was used primarily to "fan" the fire after a load of wood had been added to the underfire; once the wood was burning vigorously the blower was turned off.

Metal doors were added to the ends of the kiln after the first day of testing to prevent the smoke from escaping out the culvert ends. These are shown in Figure 11. The door at the entrance of the kiln was hinged so that it could be pushed open with a shovel as the kiln was being loaded, and close on its own when the shovel was removed. The door at the discharge end of the culvert, consisted of a flap which opened outwards to allow sediment to drop out of the kiln.

### **5.2 GENERAL OBSERVATIONS**

The feed and discharge ends of the kiln (prior to the addition of the doors) are shown in Figure 12. The sediment could be easily shovelled into the feed end of the kiln, even after the doors had been installed. The cleaned sediment was collected in a trough at the discharge end.

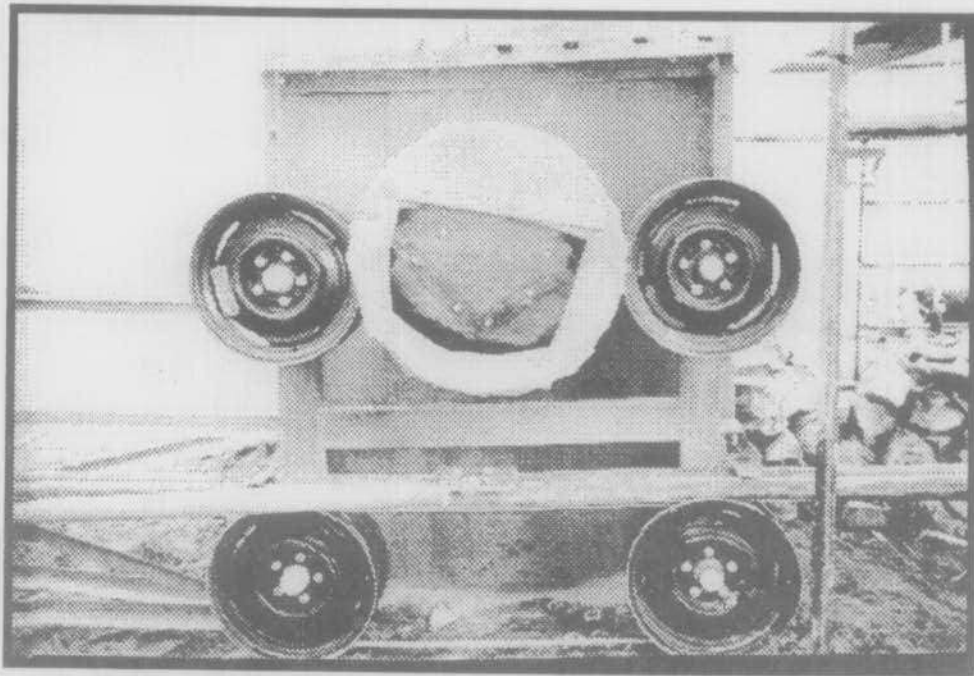

a) feed end

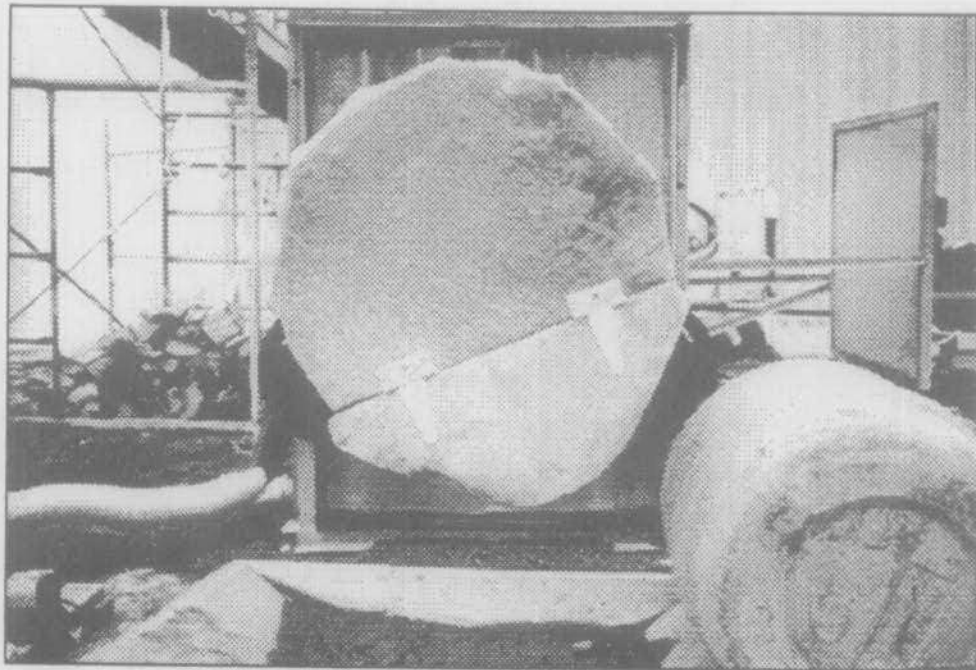

b) discharge end

Figure 11: Doors on ends of kiln

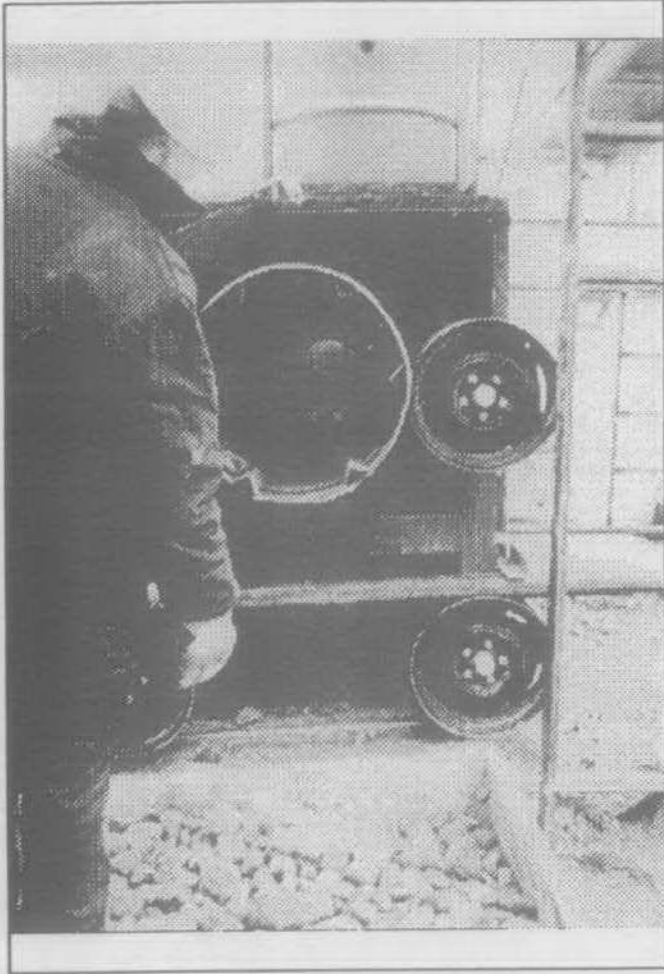

a) feed end

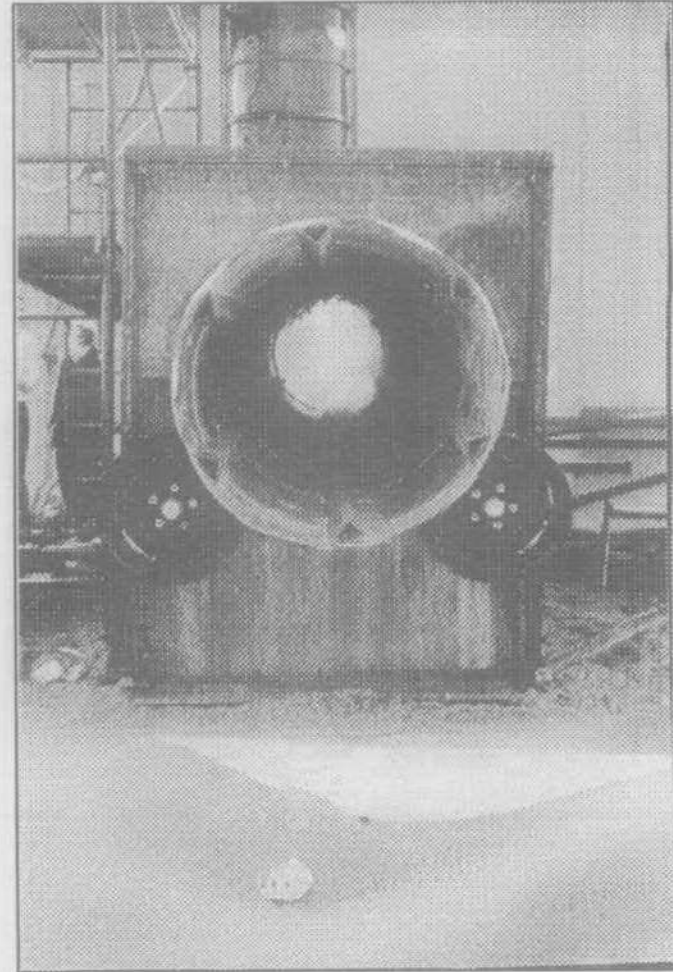

b) discharge end

Figure 12: Kiln feed and discharge ends

During runs with sediment and fresh crude or Bunker "A" combinations, the oil ignited almost immediately upon entering the kiln. The smoke generated from this combustion would either go up the stack or come out the entrance of the kiln. Sediment with weathered oil and emulsified crude tended to take longer to ignite and therefore travelled some distance (two to five feet) along the culvert before ignition. Figures 13a and 13b show the kiln in operation. Note some smoke coming out the front end of the kiln as well as from the stack.

The location of the smoke emissions (out the stack or either end of the kiln) was dependant on the wind direction, the damper position and whether or not the undertire blower was on. On calm days, the smoke generally went up the smoke stack, while on windy days, the smoke came out the downwind end of the culvert. While the addition of the doors at the ends of the culvert helped reduce this effect, the natural draft was not sufficiently strong to bring the smoke up the chimney in windy conditions. As expected, with the damper in the closed position, the kiln temperature increased but little, if any, smoke went up the stack. It was also noted that when the blower was on, less smoke went up the stack than when it was off. However, a noticeable drop in temperature occurred when the blower was turned off. It was therefore necessary find a balance between optimum temperature and acceptable emission control. Smoke density ranged from 1 to 5 on the Ringleman scale, depending on the type of oil burned. White/grey smoke in the density range of 1 to 3 was observed during the weathered oil runs. Light to dark brown smoke with densities of 3 to 4 was observed during the fresh oil runs. During the Bunker "A" runs very dark smoke was observed in the 4 to 5 range on the Ringleman scale.

In general, the sediment appeared clean after passing through the kiln, with few exceptions. Sediment with very low oil concentrations or sediment which was very wet, did not ignite and therefore was not thoroughly cleaned. When the sediment was passed through the kiln a second time, it appeared somewhat less oily, but was blackened with soot. Some of the sediment which was reused several times for testing also became charred.

It should be noted that the goal of measuring the kiln's throughput rate was not truly met. During the field tests the overriding criteria controlling throughput were visual smoke emissions and visual cleanliness of the exiting sediment. The maximum achievable kiln throughput was not tested. The feed rate varied with sediment type. The rate of reciprocation therefore had to be adjusted in order to obtain an optimum residence time. Sand, particularly wet sand, did not tumble well and therefore required the

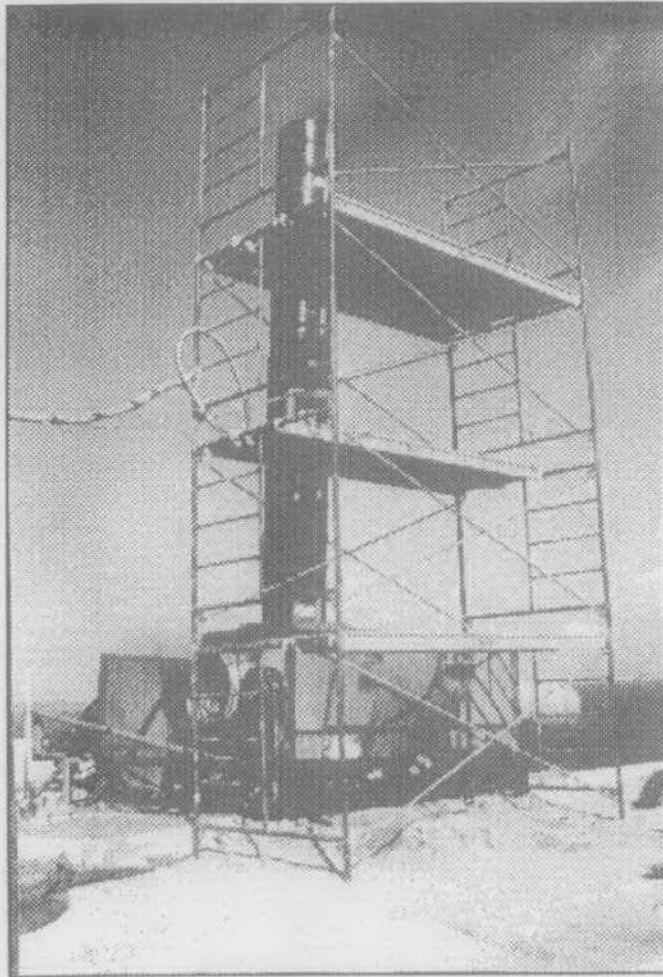

a) smoke emissions from kiln

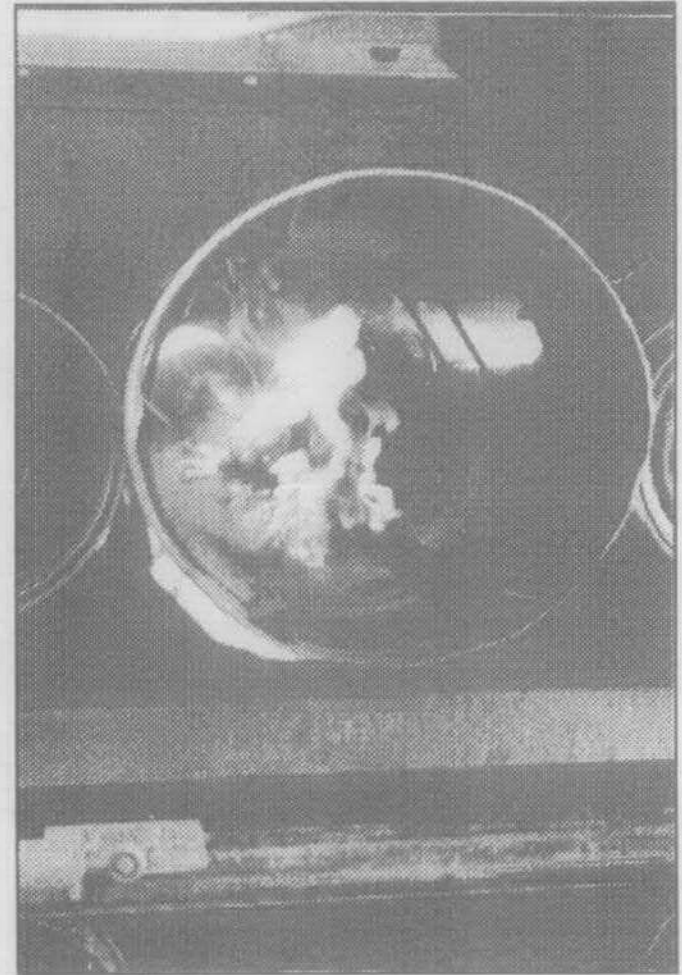

b) ignition of inside kiln

Figure 13: Reciprocating kiln in operation

highest residence time in the kiln. The tumbling of wet sand seemed to be hindered by the angle iron running along the length of the kiln. Future modifications of this kiln design might consider the possibility of increasing the angle of reciprocation or omitting some of these angle irons when using the kiln for wet sand. Gravel tumbled well and passed more rapidly through the kiln. With the mixed sediment, the gravel travelled through the kiln at a faster rate than the sand; however the presence of the gravel also improved the tumbling of the sand.

After one day of testing, the grill used to support the firewood had severely warped, particularly at the feed end of the kiln where the temperature was highest (see Figure 14). While it was still functional, a better support system could have been used. Another alternative would be to use a heavier gauge grill, although this would add weight to the system.

The damper located inside the stack warped after several runs, but this did not greatly affect the control of stack emissions.

After the first two days of testing the baffle fell (two hinges had disconnected). This resulted in the combustion smoke going directly up the stack instead of being forced around the culvert as designed. This was repaired. A future design should include more hinges or perhaps a better hinge/attachment system. As well, when the kiln was taken down, it was noted that several of the spot welds holding the baffle support "L" to the firebox roof, and holding the sheet metal to its frame had broken. These should be replaced with bolts.

### 5.3 OPERATING CONDITIONS

Operating stack temperatures (measured at the bottom of the stack for runs 1 to 6, and roughly 2 m up the stack from the firebox roof for the remaining runs) in the range of 250°C to 400°C were achieved during steady state operating of the kiln. The time required for start-up was roughly 45 to 60 minutes. During steady state operation the fire was fed at a rate of 30 to 40 pieces of wood (40 cm length x 15 cm diameter) every 50 minutes. This translates into 0.3 to 0.5 m<sup>3</sup>/hr or 0.08 to 0.13 cords per hour. This is roughly equivalent to 30 to 50 kW or 1 x 10<sup>6</sup> to 1.7 x 10<sup>6</sup> BTU/hr (assuming white pine, 50% green @ 12.9 x 10<sup>6</sup> BTU/cord and 50% air dry @ 14.2 x 10<sup>6</sup> BTU/cord).



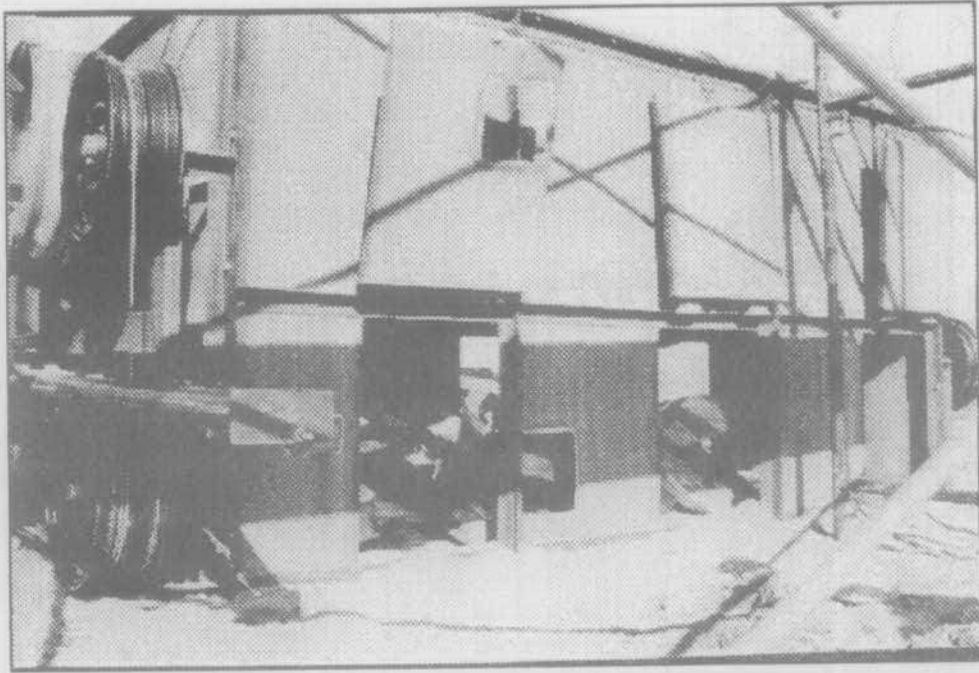

a) Firebox prior to the addition of the grill

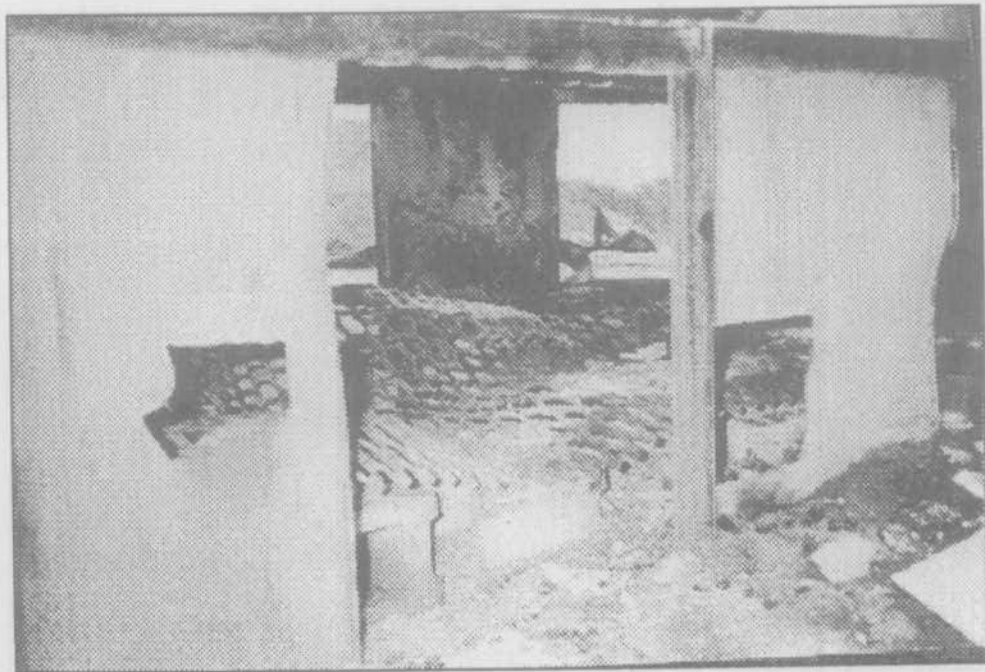

b) Warped underfire grill

Figure 14: Kiln firebox

An optimum rate of kiln reciprocation (in terms of visual sediment cleanliness) was found for each sediment type and oil combination. Sand, which travelled slowly through the kiln was processed at a rate of 8 or 10 RPM, which resulted in a residence time of 15 to 25 minutes. Gravel tumbled much more rapidly, passing through the kiln in less than 10 minutes at 10 RPM. It was therefore necessary to reduce the rate to 6 RPM. The mixed sediment was processed best at 8 RPM.

The optimum feed rate (in terms of visual sediment cleanliness) also varied with the sediment and oil type. For a given oil type, the optimum feed rate for sand was lower than gravel because of the higher surface to volume area ratio of sand. The wet sediment or sediment with emulsified oil had to be fed at a slower rate (< 200 kg/hr) than relatively dry sediment (240 to 500 kg/hr), and finally sediment oiled with fresh oil could be fed at a higher rate, up to 640 kg/hr than sediment with weathered oil.

It had been initially planned to use the firebox draft doors to adjust the flow of air to the underfire; however, the highest temperatures were obtained when all of the doors were kept closed and sealed with sand. The blower, placed at the discharge end of the kiln, was used when extra air was needed to fan the fire. The blower was turned on for initial start-up and after the addition of firewood for a period of approximately 10 minutes. Occasionally, the blower was left on for the entire run.

#### **5.4 OIL REMOVAL EFFICIENCY**

The intended objective of this test program was to study the reciprocating kiln's oil removal efficiency by determining its steady-state throughput, oil removal efficiency and stack emissions. During these trials however, priority was given to emission testing and to producing a visually clean sediment. It should therefore be noted that the feed rates obtained during testing do not reflect the maximum achievable throughput rate of the reciprocating kiln.

The results obtained during the testing are presented in Table 5. One run (No. 9 - not included in Table 5) was with very wet sand and weathered crude oil obtained from a drum which had taken on a considerable amount of water while in storage. When placed inside the kiln, this sand did not travel well along the length of the kiln but stuck to the culvert walls (as observed with other runs where the



sand was wet). Some smoking occurred but the oil did not ignite. This run was aborted after 30 minutes.

The kiln successfully cleaned most of the sediment types in the tests, with the exception of very wet sediment and sediment oiled with emulsified crude. It is not certain however whether complete combustion of the oil to  $\text{CO}_2$  and  $\text{H}_2\text{O}$  occurred. Runs 6 to 10 were conducted for long-term emissions sampling and were thus of longer duration than the runs 1 to 5. As it was necessary to prepared several batches of sediment for runs 6 to 10, they were therefore sub-divided into a), b), and c) in Table 5 providing an opportunity to sampled several several times at slightly different feed rates.

Most runs with sediment oiled with fresh and weathered crude achieved 95% oil removal or better. The exceptions were sand with 0.87% weathered oil and sand with 2.5% fresh oil, which had oil removals of 30% and 88% respectively. This difference may be attributed to sampling errors. For all runs, the samples taken were relatively small in comparison to the amount of sediment passed through the kiln and may therefore not always have been representative. The test runs with sediment oiled with Bunker "A" were also successful, achieving an oil removal efficiency of 90% or better. Sediment oiled with emulsified oil was not cleaned as thoroughly. The oil removal efficiency was less than 50% of the oil fraction in the emulsion (composed of 25 % oil and 75 % water by weight).

**TABLE 5**  
**Summary of Reciprocating Kiln Test results**

| SEDIMENT TYPE (Run No.) | OIL TYPE & LOADING (wt. %) | OIL IN OUTPUT (wt. %) | OIL REMOVED (wt. %) | STACK TEMP (°C) | KILN RPM | RESIDENCE TIME (min) | THROUGHPUT RATE (kg/hr) | IGNITION COMMENTS    | SMOKE (Ringleman Number)      |
|-------------------------|----------------------------|-----------------------|---------------------|-----------------|----------|----------------------|-------------------------|----------------------|-------------------------------|
| Sand (1)                | Weathered, 0.9             | 0.61                  | 32.2                | 250             | 10       | 8 to 12              | 300                     | after 2 to 4 minutes | 1 to 3, usually 2 white/grey  |
|                         |                            | 0.23                  | 74.4                | 358             | 10       |                      |                         |                      |                               |
| Gravel (2)              | Weathered, 0.3             | 0.00                  | 99.9                | 250             | 10       | N.M.                 | 300                     | sporadic             | N.M.                          |
|                         |                            | 0.00                  | 99.9                | 333             | 10       |                      |                         |                      |                               |
| Mixture (4)             | Weathered, 0.4             | 0.02                  | 95.9                | 384             | 6        | 22                   | 300                     | after 4 minutes      | 1 to 3, mainly 2, light brown |
| Sand (6) (Part 1)*      | a)Fresh, 2.5               | 0.05                  | 97.5                | 375             | 8        | 24                   | 360                     | immediate            | N.M.                          |
|                         |                            | 0.01                  | 99.2                |                 | 8        | 24                   | 360                     | immediate            |                               |
|                         |                            | N.M.                  |                     |                 | 8        | 24                   | 525                     | immediate            |                               |
|                         |                            | 0.3                   | 88.0                |                 | 8        | 24                   | 384                     | immediate            |                               |
| Gravel (3)              | Fresh, 1.4                 | 0.00                  | 99.9                | 308             | 10       |                      | 340                     | immediate            | N.M.                          |
|                         |                            | 0.00                  | 99.9                | 391             | 6        | 20                   |                         | immediate            |                               |
|                         |                            | 0.00                  | 99.9                |                 | 6        | 20                   |                         | immediate            |                               |
| Mixture (5)             | Fresh, 2.3                 | 0.00                  | 99.9                | 390 - 460       | 6        | 22                   | 640                     | immediate            | 3 to 4, at times 5            |
|                         |                            | 0.02                  | 99.4                | 320 - 260       | 6        | 22                   | 640                     | immediate            |                               |
| Sand (7) (Part 2)†      | a)Bunker "A", 2.5          | 0.01                  | 99.6                | 300             | 8        | 15                   | 240                     | immediate            | 4 to 5, very dark             |
|                         |                            | 0.12                  | 96.0                | 350             | 8        | 15                   | 400                     | immediate            | 4 to 5, very dark             |
|                         |                            | 0.04                  | 98.6                | 280             | 8        | 15                   | 345                     | immediate            | 4 to 5, very dark             |
| Mixture (8) (Org 1&2)†  | a)Bunker "A", 2.4          | 0.01                  | 99.4                | 250             | 6        | 22                   | 310                     | immediate            | 4 to 5, very dark             |
|                         |                            | 0.04                  | 98.4                | 280             | 6        | 22                   | 320                     | immediate            | 4 to 5, very dark             |
|                         |                            | 0.27                  | 89.2                | 300             | 6        | 22                   | 385                     | immediate            | 4 to 5, very dark             |
| Sand (10) (Org 3)†      | a)Emulsified, 2.5‡         | 0.41                  | 34.4                | 300             | 10       | 24                   | 185                     | very little          | N.M.                          |
|                         |                            | 0.39                  | 37.6                | 270             | 10       | 24                   | 185                     | very little          |                               |
|                         |                            | 0.32                  | 48.8                | 270             | 10       | 24                   | 185                     | very little          |                               |

N.M. = not measured, † run designators used by PMD (refer to Appendix C), ‡ emulsion consists of 25% oil, 75% water by wt.

## 5.5 STACK EMISSIONS

The emissions data from the kiln testing were generated from samples collected and analysed by the Pollution Measurement Division of Environment Canada. A summary of the emissions monitoring and sampling results can be found in Table 6. The complete data set generated from the emissions sampling is located in Appendix C.

Data for the continuous emission monitoring (CEM) is given in graphical form for runs 6 to 10. The data is also summarized in a table showing the raw CEM concentration data and the corrected CEM data (corrected to 11% oxygen). The continuous monitoring program recorded concentrations of SO<sub>2</sub>, NO<sub>x</sub>, CO, THC(h) (Total Hydrocarbons), O<sub>2</sub>, and CO<sub>2</sub>. The emission concentrations, corrected to 11% oxygen ranged from 25 to 52 ppm for SO<sub>2</sub>, from 55 to 84 ppm for NO<sub>x</sub>, from 2513 to 3835 ppm for CO and from 660 to 1536 ppm for THC(h).

The particulate emissions testing consisted of two runs of 96 minutes each, and was performed during run 6 (sand and 2.5% fresh crude) and run 7 (sand and 2.8% Bunker "A"). SO<sub>2</sub> concentrations averaged 25 ppm and 26 ppm during runs 6 and 7 respectively. While the stack gas characteristics - actual velocity, flowrate, temperature, moisture oxygen and carbon dioxide - were similar during both runs, the particulate emission rate was higher during the fresh crude run (18.24 kg/day with an average concentration of 768.7 mg/m<sup>3</sup>) than during the Bunker "C" run (12.25 kg/day with an average concentration of 452.5 mg/m<sup>3</sup>). The difference can likely be attributed to the higher sediment feed rate during run 6. The average feed rate for the fresh crude run was 423 kg/hr compared to 328 kg/hr for the Bunker "C" run. A list of the volatile organic compounds (VOCs) with levels above 1000 µg/m<sup>3</sup> found in the stack gases for these runs is also given in Appendix C.

The polycyclic aromatic hydrocarbons (PAH) emission testing was conducted during runs 8 (mixed sediment with 2.5% Bunker "A") and 10 (sand and 2.5% emulsion). SO<sub>2</sub> concentrations averaged 52 ppm and 45 ppm for run 8 and 10 respectively - somewhat higher than the concentrations observed in runs 6 and 7. Again, the stack gas characteristics were similar to those of runs 6 and 7. The PAH's emissions however differed significantly. During run 8, the PAH concentrations were 6385 µg/m<sup>3</sup> with an emission rate of 143 g/day, whereas during run 10, the PAH concentration were 2373 µg/m<sup>3</sup> with an emission rate of 50 g/day. Higher levels of PAHs were expected during run 8 given the higher feed

rate and oil loading in run 8 - 2.5% Bunker "A" at 310 to 385 kg/hr vs. 2.5% emulsion (25% oil/75% water) at 185 kg/hr in run 10. It is also likely that Bunker "A" contained more PAHs than the Ontario light crude used to make the emulsion.

It should be noted here that the results from the emissions sampling represent particulate and PAH emissions from the combustion of oil on the sediment and as well as from the wood used as underfire. As a baseline run with the reciprocating kiln burning wood only was not conducted, it is not possible to determine the relative contributions between oil and wood. As well, these results represent emissions from the stack only, and do not account for the considerable amount of smoke lost from either end of the kiln.

TABLE 6  
Summary of stack emissions

| RUN NO.                                 | 6      | 7      | 8    | 10   |
|---|--------|--------|------|------|
| SO <sub>2</sub> (ppm)                   | 25     | 26     | 52   | 45   |
| NO <sub>X</sub> (ppm)                   | 55     | 64     | 70   | 84   |
| CO (ppm)                                | 2684   | 2513   | 3835 | 3624 |
| THC(h) (ppm)                            | 875    | 660    | 1159 | 1536 |
| Particulate conc'n (mg/m <sup>3</sup> ) | 768.7  | 452.5  |      |      |
| Particulate emission rate (kg/day)      | 18.24  | 12.25  |      |      |
| VOC emission (ug/m <sup>3</sup> )       | 138749 | 171896 |      |      |
| PAH concentration (ug/m <sup>3</sup> )  |        |        | 6385 | 2373 |
| PAH emission rate (g/day)               |        |        | 143  | 50   |

## 6.0 CONCLUSIONS AND RECOMMENDATIONS

### 6.1 CONCLUSIONS

In general the kiln performed adequately and was capable of effectively removing oil from a variety of beach sediment types. The following conclusions arose from this full scale trial of the redesigned reciprocating kiln.

1. Freshly oiled sediment readily ignited when placed inside the kiln. Sediment containing 2-year old weathered oil required approximately 5 minutes of preheating before ignition occurred. Sediment containing emulsified oil (with 75 wt% water) ignited only briefly while very wet sediment did not ignite at all. Oil removal efficiencies of at least 90% were achieved with sediment oiled with fresh crude, weathered crude and Bunker "A". Less than 50% oil removal efficiency was achieved with sediment oiled with emulsified crude oil. Oil present on very wet sediment did not ignite, and was not be successfully removed from the sediment.
2. Higher residence times are required for oiled sand than for oiled gravel or mixed sediment, perhaps because sand, particularly when wet, has less of a tendency to tumble in the kiln than the other sediment types.
3. As constructed, the kiln is durable and has proven capable of withstanding extreme environmental conditions (a hurricane storm) and two weeks (roughly 60 hours) of continuous use without serious deterioration.
4. The maximum achievable throughput of the redesigned kiln was not determined.

## 6.2 RECOMMENDATIONS

As a results of these tests, the following improvements to the prototype are recommended:

1. Improved tumbling of sand should be considered. This could possibly be achieved by making changes to the location of the angle iron inside the kiln or by periodically omitting sections of angle iron down the length of the kiln. As well increasing the degree of rotation may improve tumbling.
2. Permanent, hinged doors, similar to those built on-site, should be added to the inlet and outlet of the kiln.
3. The length of angle iron ("L") to which the baffle is hinged, should itself be bolted through the firebox roof to the structural cross-members ("L"'s) on the firebox roof. This would overcome the problem of the weight of baffle breaking the spot welds holding the support "L" to the firebox roof sheet metal.
4. The diameter of the damper in the stack should be reduced by 1 to 2 cm to prevent binding; this may necessitate the addition of some type of catch on the outside of the stack to hold the baffle open/closed.
5. Wrench access holes need to be incorporated into the design to allow the stack to be attached to its support frame ("L"'s) on the kiln roof.
6. The hinge pins supporting the internal baffle should be replaced with double-nutted bolts to prevent their falling out due to vibration during kiln operation.
7. A system should be set up to facilitate underfire refuelling, possibly a chute. As well the use of smaller pieces of wood would improve burning efficiency. If it were feasible to use wood chips, a blower could perhaps be used to feed the fire.

8. A grill for providing air space between the ground and the wood used for underfire should be included in the firebox design. The use of an underfire blower or air diffuser should also be considered.
9. Minimal instrumentation to indicate stack temperature and draft should be added to facilitate control of operating conditions.
10. The addition of an afterburner to improve combustion and reduce smoke emissions should be investigated, while maintaining to the initial the criteria of portability and simplicity.

## 7.0 REFERENCES

- Bayliss, R. and R. Spoltman. 1981. The wreck of the Lee Wang Zin. Proc. 1981 Oil Spill Conf. API. Washington.
- Bennett, J.A., I.R. McAllister, L. Pertile and Dan McQillan. 1987. Removal of stranded oil from remote beaches by in-situ combustion. ESRF report 074. Ottawa.
- Gill, S.D. and Stevens, G., Use of the TRECAN-PACE oil drum incinerator during the kurdistan clean-up operation, Canadian Coast Guard Emergencies, Ottawa, Ontario, Spill Technology Newsletter, January-February 1980.
- Meikle, K.M. and H.B. Ewing. 1980. Oil spill incinerator development: and update. Proc. AMOP Technical Seminar. Edmonton.
- S.L. Ross Environmental Research Limited. 1990. Development and testing of a prototype rockwasher for cleaning oiled beach cobble. Report to Environment Canada, EED. Ottawa.
- TRECAN LIMITED, Determination of the Combustion Characteristics of an Oil-sand Mixture, Mississauga, Ontario, March 1977.
- TRECAN LIMITED, Study the possibilities of burning a melange of sand and petroleum products in a mobile apparatus, Mississauga, Ontario, June 1976.
- Swiss, James J., Smrke, Donald J., and Pistruzak, William M., Unique disposal techniques for arctic oil spill response, Dome Petroleum, Calgary, Alberta, 1985 Oil Spill Conference Proceedings.



**APPENDIX A**  
**RECIPROCATING KILN USER'S GUIDE**

The Reciprocating Kiln is a heliportable unit, designed for the clean-up of remote shorelines which would otherwise be difficult to reach using conventional methods and equipment. The following is intended as a User's Guide.

### 1. Set-up

- The reciprocating kiln should be set up on a flat, non-flammable surface. It is advisable to set the unit up on a sand pad in order to: prevent further oiling of the ground below, reduce vibration of the kiln and drive components, provide a seal around the bottom of the kiln box and to provide a means of leveling the kiln and engine module.
- Guy wires should be attached to the stack and securely anchored using appropriately sized weights, placed around the base of the kiln.

### 2. Start-up:

- When using wood as the underfire, roughly 40 to 60 minutes is required to reach operating temperature (approximately 400°C). The diesel should be started and the kiln kept in motion once the underfire has started to avoid overheating and damage to the culvert. The kiln is sufficiently pre-heated when a dry stick begins to smoke and char immediately on being thrown into the kiln.
- The kiln can be manually loaded using shovels.
- Operating conditions can be adjusted to suit the sediment type and oil. Sediment tumbling can be adjusted by changing the rate of reciprocation by adjusting the speed at which the diesel engine is run. Air flow can be controlled by adjusting the damper and the firebox doors, as well as by turning the blower on or off.

### 3. Shut-down:

- When shutting down the reciprocating kiln it is important to ensure that proper cooling takes place so as to avoid overheating and damage to the unit, in particular the culvert. The kiln must be allowed to cool for approximately one half hour prior to shutting down the diesel engine. During this time, the draft doors can be opened to accelerate cooldown. The fire may also be extinguished if that is deemed necessary.

#### 4. Maintenance:

- To avoid rusting and seizing of moving parts (door hinges, damper, drive system, etc.) the kiln should be kept indoors and all moving parts kept well lubricated.
- The diesel engine and blower should be maintained as recommended in their service manuals.

#### 5. Safety

The reciprocating kiln has several moving parts and generates a large amount of heat, as well as smoke, particulates and noise. Caution must therefore be used when working in the vicinity of the unit.

- Flammables should be kept at least 5 meters away from the kiln.
- A firefighter's suit is recommended for refueling the underfire.
- Breathing apparatus is recommended when burning heavier oils (i.e. Bunker "A"), if inefficient burning occurs (smoke is dark), or if the smoke is not going directly up the stack.
- Eye protection is recommended as the larger sediment occasionally bursts when heated inside the kiln and the particles can be projected out of the kiln ends. This is particularly important at the feed end of the kiln.
- Ear protection is also recommended.

**APPENDIX B**  
**BLUEPRINTS, EQUIPMENT LIST**  
**AND DRAFT CALCULATIONS**

## DRAFT CALCULATIONS

The draft calculations indicated that a single 0.6 m (2 foot) diameter, 6 m (20 foot) high stack would draw enough air (assuming a 425°C stack gas temperature) to combust either 1/3 of a cord of wood per hour or 200 kg of oil per hour (i.e., 2 tonnes per hour of sediment with 10% oil or 4 tonnes per hour with 5% oil) with 25-50% excess air. The net heat release rate would be approximately  $2.5 \times 10^6$  kCal/hr ( $1 \times 10^7$  BTU/hr). To heat 2 tonnes/hr of sand or stone from, 0°C to 400°C (the auto ignition temperature for Bunker "C") would theoretically require  $1.6 \times 10^5$  kCal/hr, without considering heat transfer losses and inefficiencies.

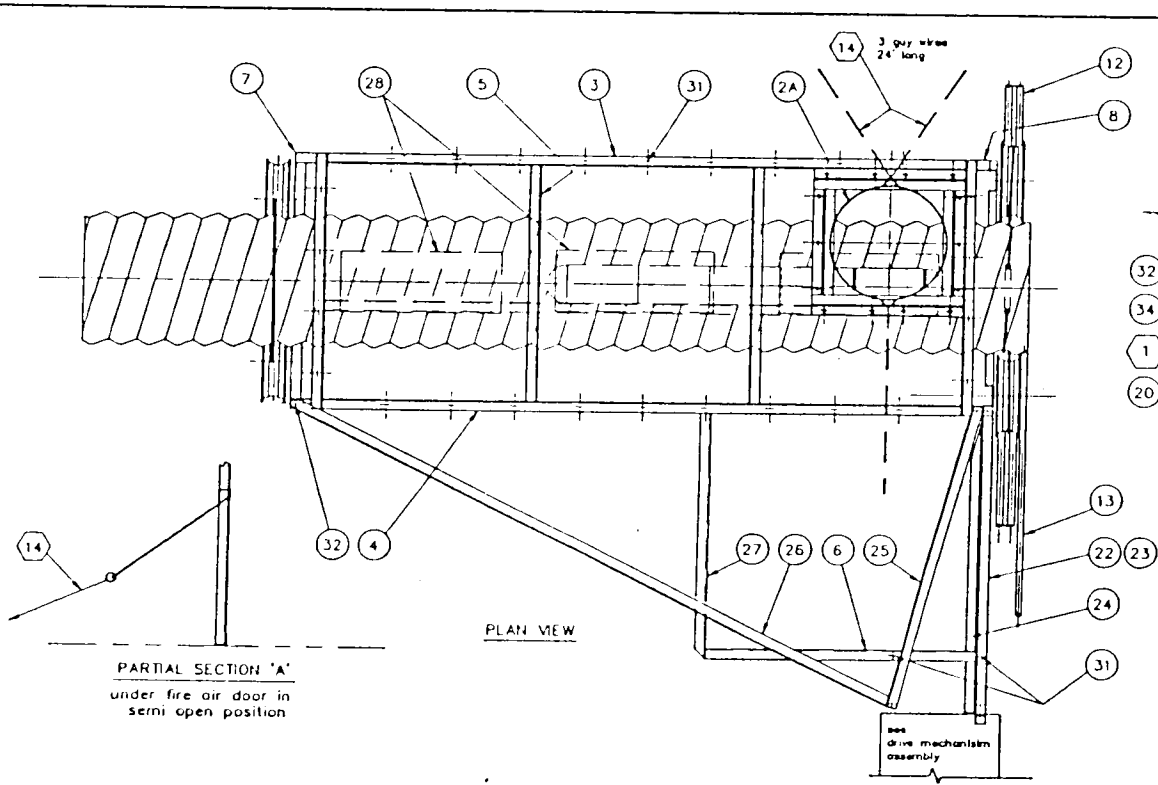

PLAN VIEW

PARTIAL SECTION 'A'  
under fire air door in  
semi open position

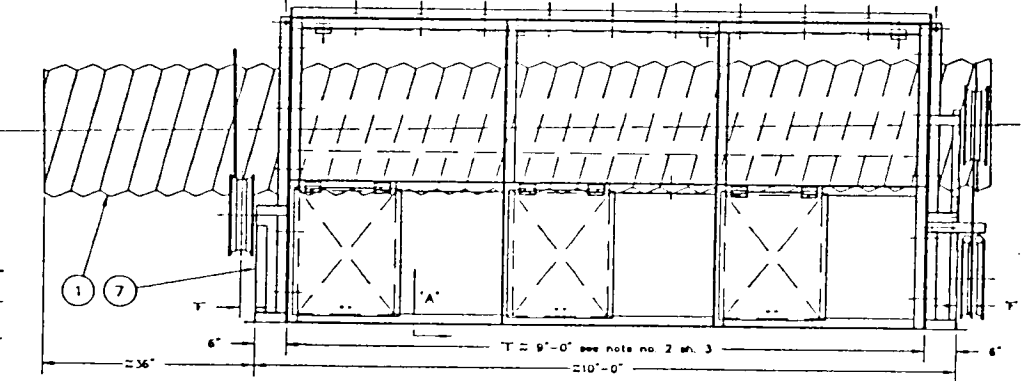

ELEVATION

drive mechanism omitted  
for clarity

| ITEM NO'S SHOWN IN DRAWING             | DETAILS ON SHEET NO. |
|--|----------------------|
| 1, 2, 3, 4                             | 418 - 2              |
| 5, 6, 7                                | 418 - 2              |
| 7, 8, 9, 10, 11                        | 418 - 4              |
| 12, 13, 14, 15, 16, 17, 18, 19         | 418 - 8              |
| 20, 21, 22, 23, 24, 25, 26, 27, 28, 29 | 418 - 8              |

ITEM NO'S SHOWN IN DRAWING AS PER SHEET NO. 4

| ITEM NO. | ITEM NAME                | PART NO. | QTY. | UNIT | REMARKS |
|----------|--------------------------|----------|------|------|---------|
| 20       | HEAVY HO. BOLT 6/8 X 3/4 |          | 2    | EA   |         |
| 21       | HEAVY HO. BOLT 6/8 X 3/4 |          | 2    | EA   |         |
| 22       | HEAVY HO. BOLT 6/8 X 3/4 |          | 2    | EA   |         |
| 23       | HEAVY HO. BOLT 6/8 X 3/4 |          | 2    | EA   |         |
| 24       | HEAVY HO. BOLT 6/8 X 3/4 |          | 2    | EA   |         |
| 25       | HEAVY HO. BOLT 6/8 X 3/4 |          | 2    | EA   |         |
| 26       | HEAVY HO. BOLT 6/8 X 3/4 |          | 2    | EA   |         |
| 27       | HEAVY HO. BOLT 6/8 X 3/4 |          | 2    | EA   |         |
| 28       | HEAVY HO. BOLT 6/8 X 3/4 |          | 2    | EA   |         |
| 29       | HEAVY HO. BOLT 6/8 X 3/4 |          | 2    | EA   |         |

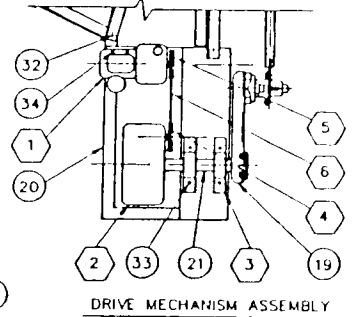

DRIVE MECHANISM ASSEMBLY

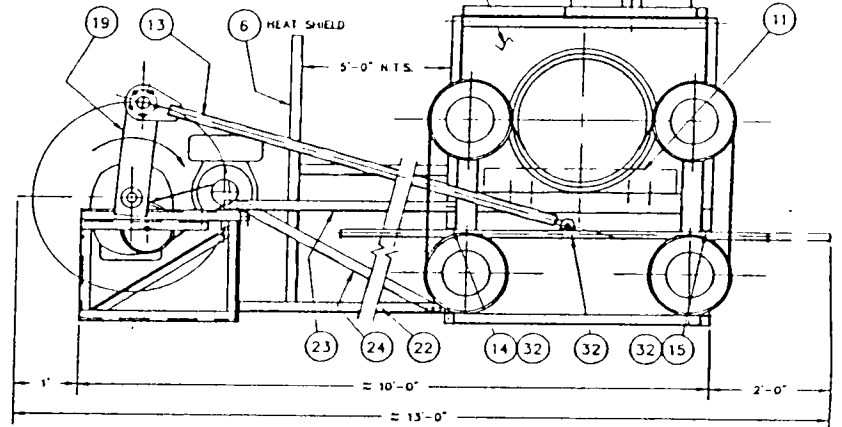

PROFILE

TOTAL WEIGHT: 2500 lbs.

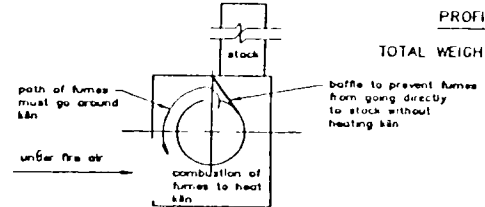
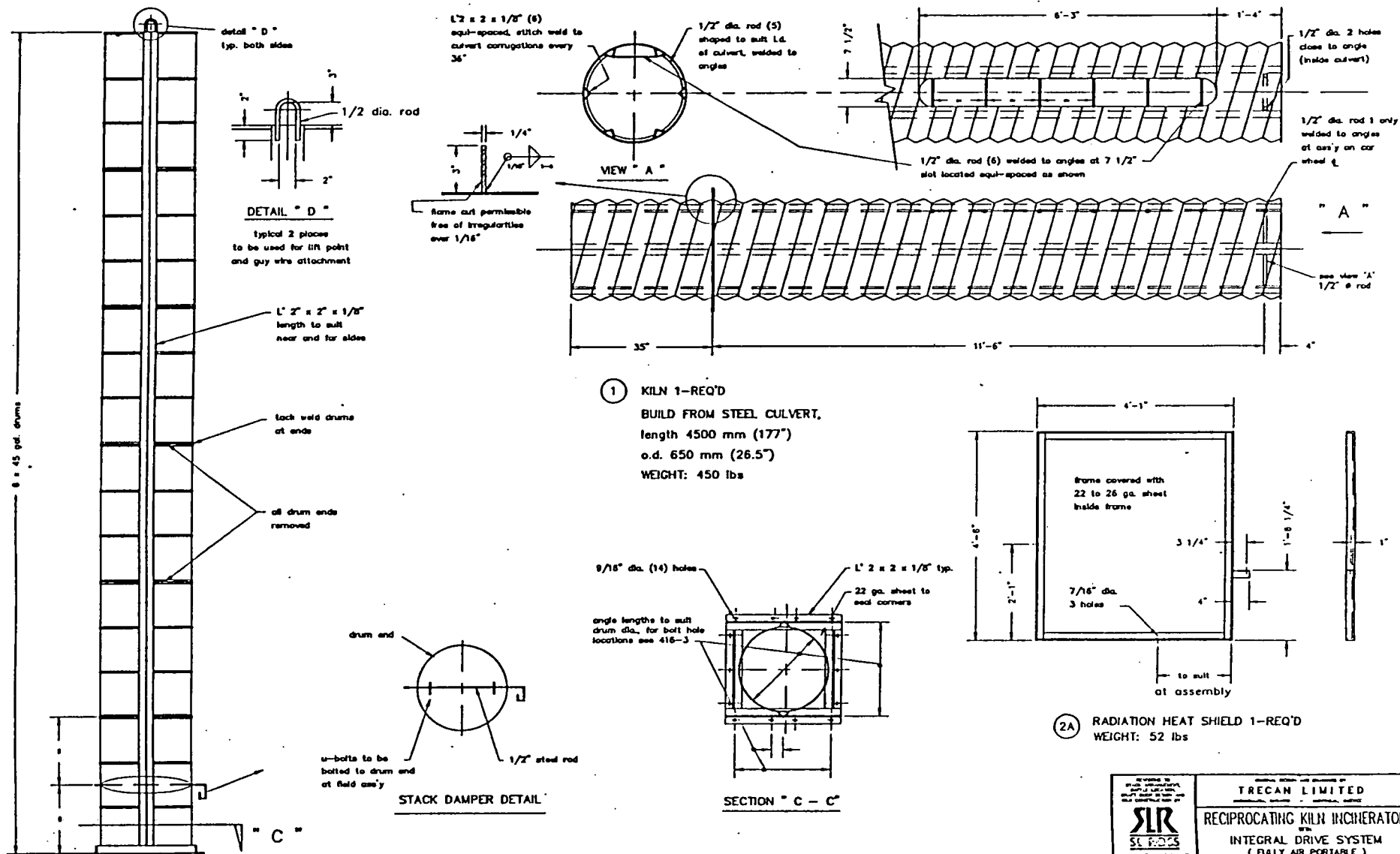

DIAGRAM ILLUSTRATING INCINERATOR  
PROCESS PRINCIPLE

|  |   |
|--|---|
| <br>SPECIAL SERVICES<br>ENVIRONMENTAL BRANCH<br>RECIPROCATING KILN<br>RECIPROCATING KILN | <b>TRECAN LIMITED</b><br>RECIPROCATING KILN INCINERATOR<br>WITH<br>INTEGRAL DRIVE SYSTEM<br>( FULLY AIR PORTABLE )<br>GENERAL ARRANGEMENT |
|  | ENVIRONMENTAL EMERGENCY BRANCH E.P.S.   |
|  | 418 - 1 - D 2   |
|  | 11-17   |

Revisions Date By



2A STACK 1-REQ'D BUILD FROM 45 gal. DRUMS (6)  
WEIGHT: 250 lbs

|  |  |
|--|--|
| <small>DESIGNED BY<br/>D. J. HARRIS<br/>CHECKED BY<br/>D. J. HARRIS<br/>DATE 11/15/83</small><br><b>SIR</b><br><small>STEEL INDUSTRIES<br/>RESEARCH</small><br><small>DRUMMIA EXHIBITOR<br/>1000 WEST 10TH AVENUE<br/>DENVER, CO 80202</small> | <small>MANUFACTURED BY</small><br><b>TRECAN LIMITED</b><br><small>1000 WEST 10TH AVENUE<br/>DENVER, CO 80202</small>   |
|  | <b>RECIPROCATING KILN INCINERATOR</b><br><small>WITH</small><br><b>INTEGRAL DRIVE SYSTEM</b><br><small>( FULLY AIR PORTABLE )</small><br><b>KILN AND STACK DETAILS</b> |
|  | <small>ENVIRONMENTAL EMERGENCY BRANCH E.P.S.</small>   |
|  | <b>416 - 2 - D</b>   |

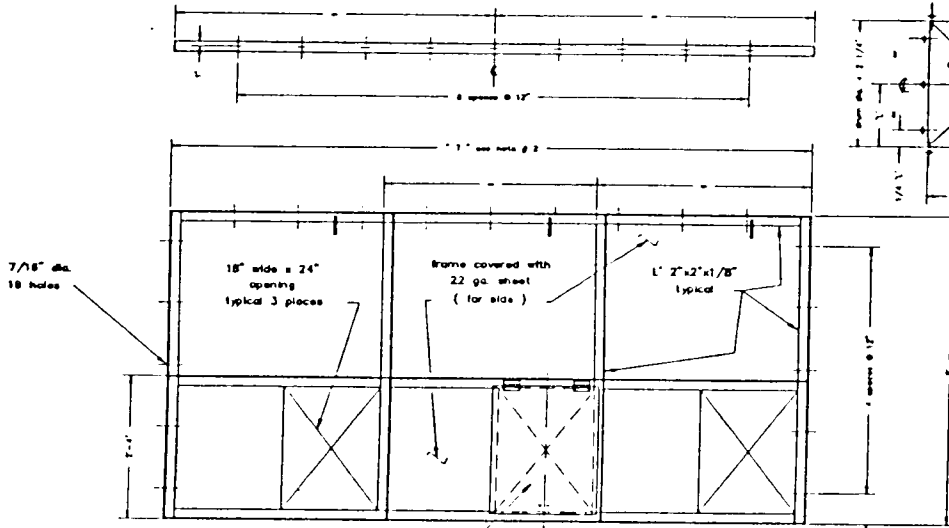

see door detail "G 2"  
**3** SIDE PANEL 1- REQ'D  
 WEIGHT: 185 lbs

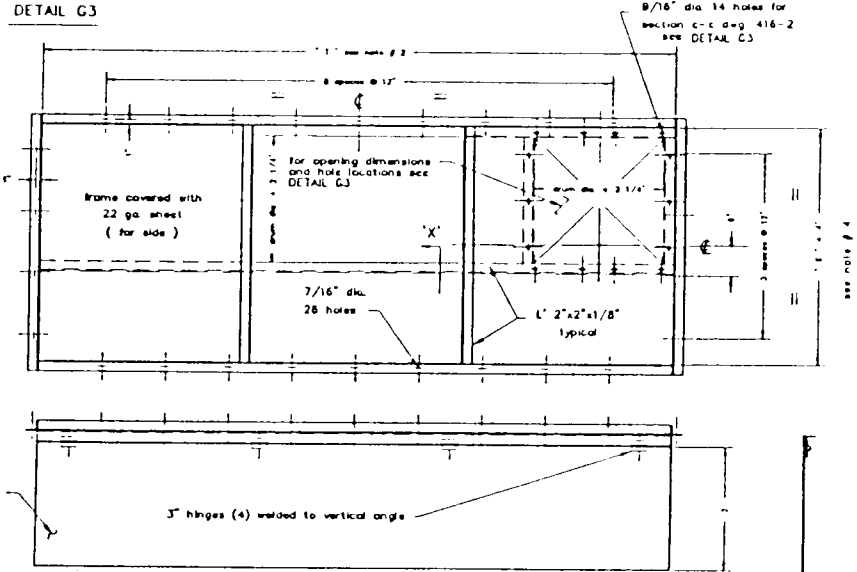
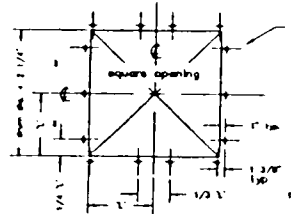

**5** CEILING and BAFFLE  
 WEIGHT: 235 lbs

SECTION 'X'

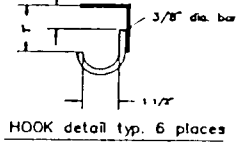

HOOK detail typ. 6 places

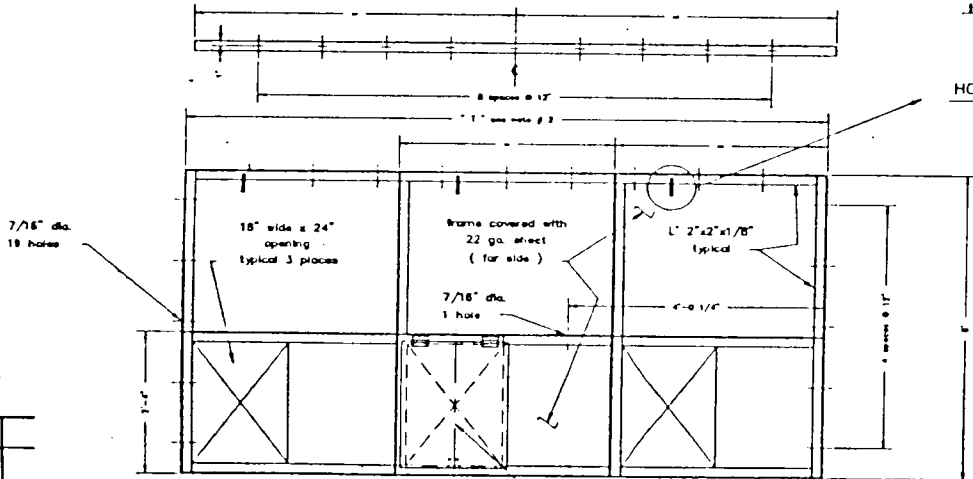

see door detail "G"  
**4** SIDE PANEL 1- REQ'D  
 WEIGHT: 152 lbs

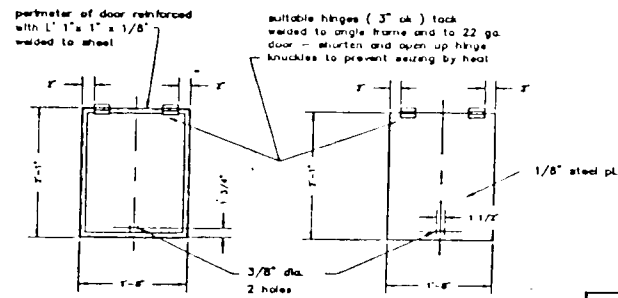

DETAIL "G"  
 showing under fire air door  
 for side panel # 4  
 typical 3 places

DETAIL "G2"  
 showing under fire air door  
 for side panel # 3  
 typical 3 places

- NOTES:
1. Lock or spotweld sheets to frames at every 6"
  2. "T" = L-28-12"  
 L from deg 416-2  
 F from deg 416-4
  3. "U" =  $S + 4 - \frac{50n \text{ dia.}}{2}$
  4. "S" from deg 416-4

Revisions  
 Date  
 By

|   |  |
|---|--|
| <br><b>SLR</b><br>SERRAVALLO<br>LINGUISTI & ASSOCIATES<br>2500 W. 10th Street<br>Denver, CO 80202<br>303-733-1111 | <b>TRECAN LIMITED</b><br>RECIPROCATING KILN INCINERATOR<br>INTEGRAL DRIVE SYSTEM<br>(FULLY AIR PORTABLE)<br>DETAILS OF SECONDARY CHAMBER |
|   | ENVIRONMENTAL EMERGENCY BRANCH E.P. 5  |
|   | 416 - 3 - D 2  |
|   | 11/17  |



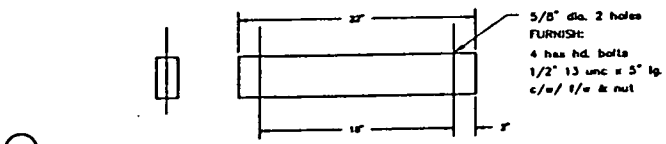

11 KILN TEMPORARY SUPPORT 1-REQ'D  
MAT'L: 2 x 4 x 22" lg. lumber

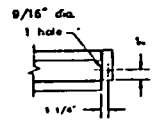

SECTION G - G

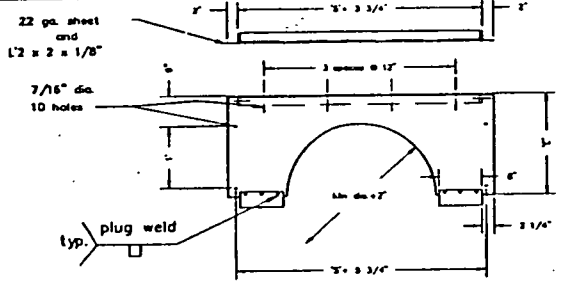

9 REAR END COVER 1-REQ'D 'E'=22 3/4"  
10 FRONT END COVER 1-REQ'D 'E'=19 3/4"

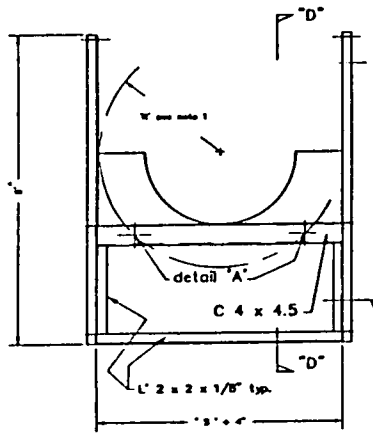
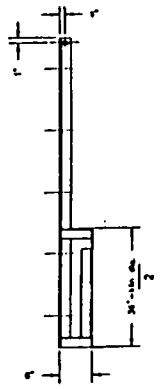
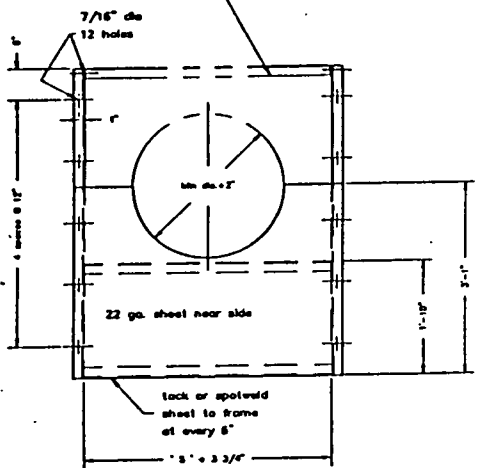
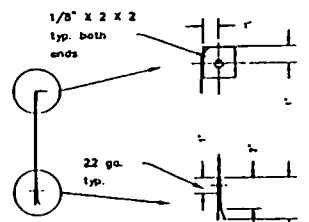

SECTION D - D

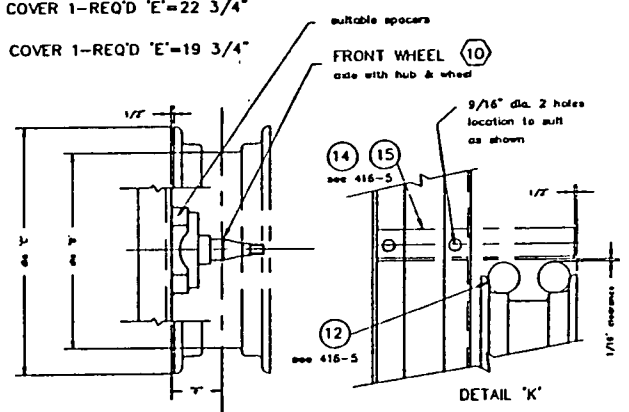

DETAIL 'A' typ. 6 places showing wheel side welded to frame

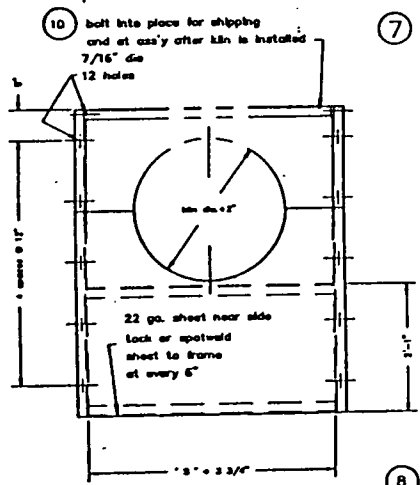

7 REAR END FRAME 1-REQ'D  
WEIGHT: 140 lbs

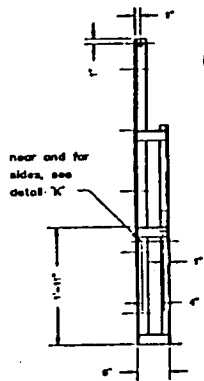

11 to support kiln at assembly

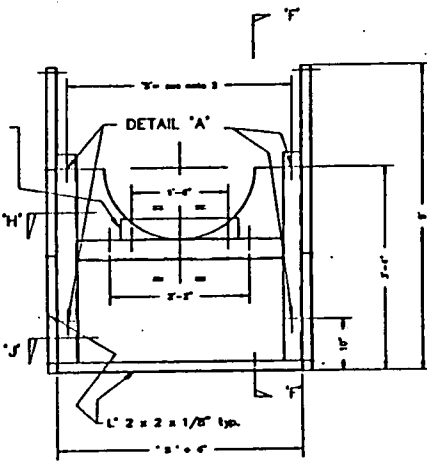

SECTION F - F

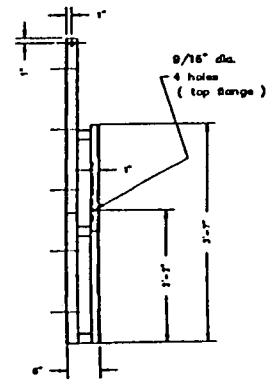

- NOTES:
1.  $R = \text{kiln dia.} + \text{dia. 'B'} + 3"$
  2.  $S = \text{kiln dia.} + \text{dia. 'C'} + 1/4"$
  3. 'B', 'C' shown in detail 'A'
  4. kiln dia. = 650mm o.d. (25.6")

SECTION H - H

SECTION J - J

Revisions Date By

|  |  |   |  |
|--|--|---|--|
|  |  | TRECAM LIMITED  |  |
|  |  | RECIPROCATING KILN INCINERATOR  |  |
| DRUMMOND ENGINEERING<br>1000 W. 10th St.<br>Denver, CO 80202 |  | INTEGRAL DRIVE SYSTEM<br>(FULLY AIR PORTABLE)<br>KILN SUPPORT FRAME DETAILS |  |
| ENVIRONMENTAL EMERGENCY BRANCH E.P.S.                        |  | 416 - 4 - D 1   |  |

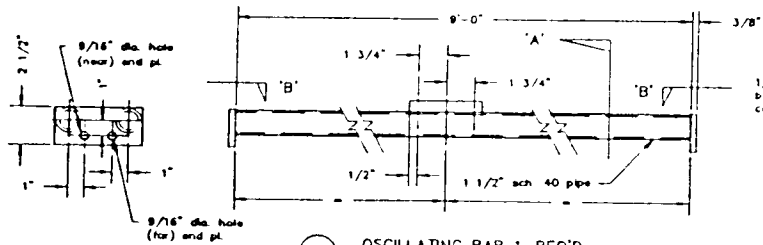

12 OSCILLATING BAR 1-REQ'D  
WEIGHT: 55 lbs

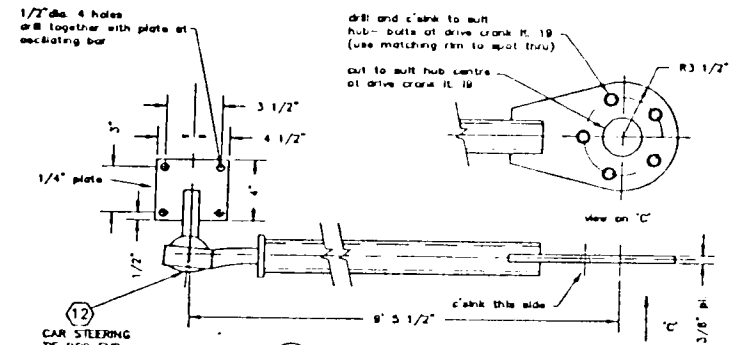

13 CONNECTING ROD 1-REQ'D  
WEIGHT: 40 lbs

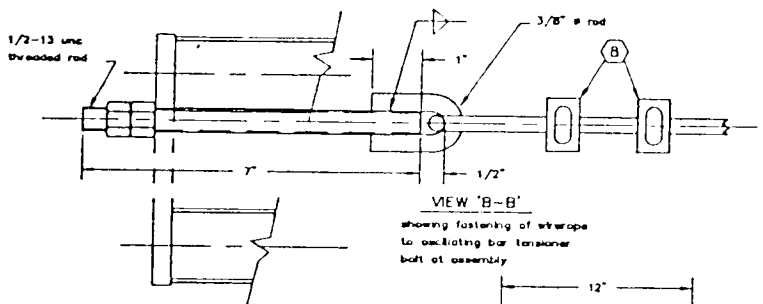

14 OSCILLATING BAR RETAINER 1-REQ'D (AS SHOWN)

15 OSCILLATING BAR RETAINER 1-REQ'D (OPPOSITE HAND)  
WEIGHT: 1.5 lbs. ea.

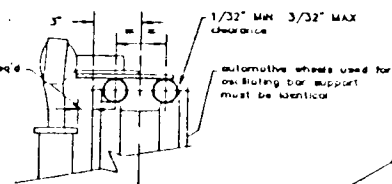

SECTION 'A-A'

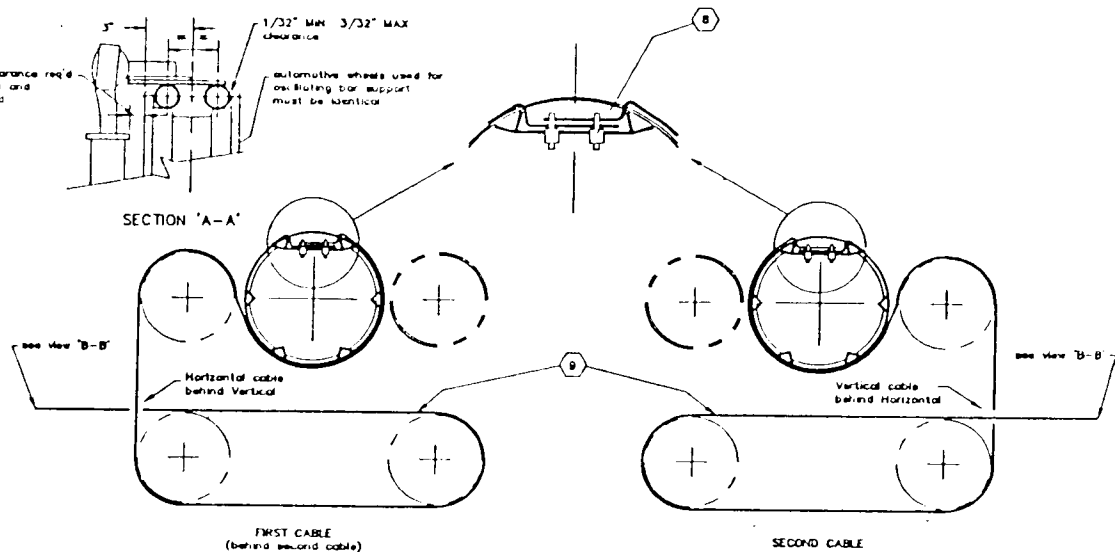

ARRANGEMENT OF DRIVE CABLES

2 CABLES REQUIRED 5/16" MIN. DIA.  
APPROXIMATE 44 FT. TOTAL LENGTH  
WEIGHT: 10 lbs

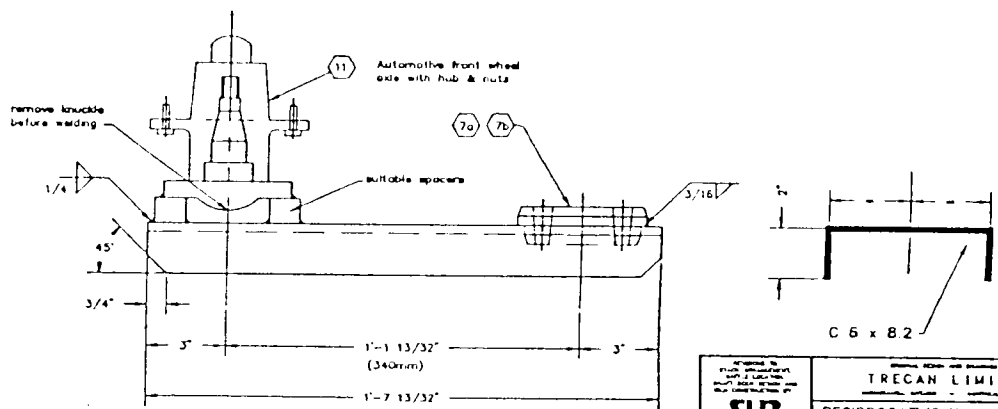

19 DRIVE CRANK 1-REQ'D  
WEIGHT: 32 lbs

|  |  |
|--|--|
| <p>RECIPROCATING KILN INCINERATOR<br/>INTEGRAL DRIVE SYSTEM<br/>(FULLY AIR PORTABLE)<br/>ARRANGEMENT OF DRIVE CABLES AND DETAILS</p> |  |
| <p>ENVIRONMENTAL EMERGENCY BRANCH E.P.E.</p>   |  |
| <p>416 - 5 - D 2</p>   |  |

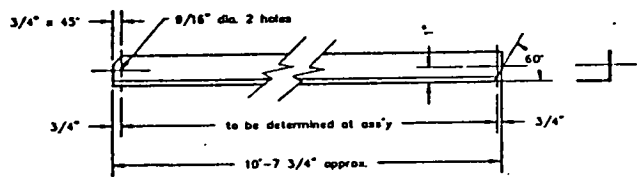

26 BRACE 1-REQ'D MAT'L: L' 2 X 2 X 1/8"  
WEIGHT: 17.5 lbs see note at 22

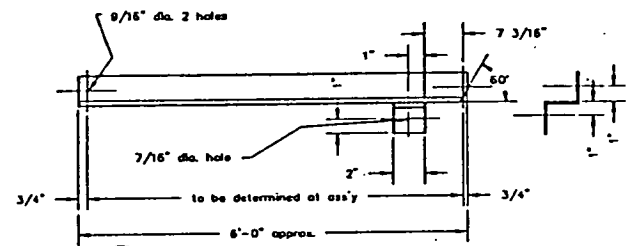

25 BRACE 1-REQ'D MAT'L 2 X 2 X 1/8"  
WEIGHT: 10 lbs see note at 22

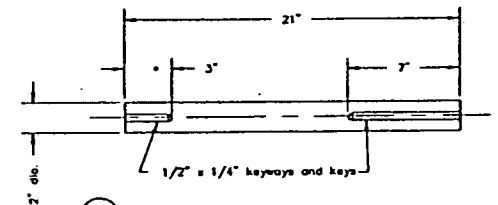

21 SHAFT 1-REQ'D, MAT'L: ground steel bar  
WEIGHT: 19 lbs

NOTE:  
1/2\"/>

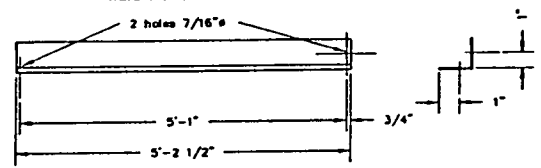

27 BRACE 1- REQ'D MAT'L: L' 2 X 2 X 1/8"  
WEIGHT: 8.5 lbs see note at 22

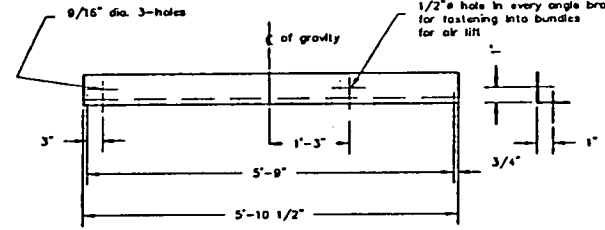

22 BRACE 1-REQ'D MAT'L L'2 x 2 x 1/8"  
WEIGHT: 9.7 lbs

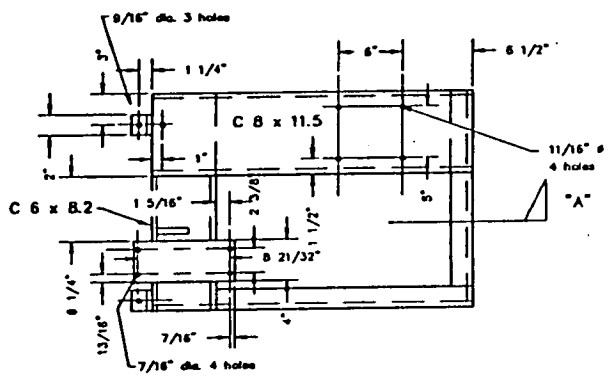

20 DRIVE FRAME 1-REQ'D MAT'L: MILD STEEL  
WEIGHT: 86 lbs  
2\"/>

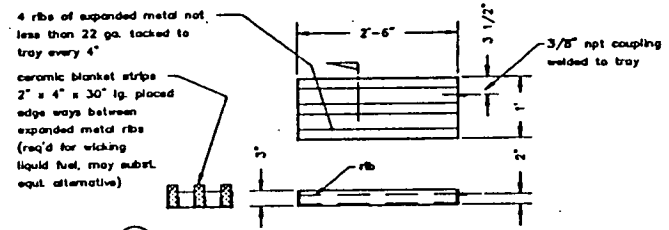

28 TRAY 3-REQ'D MAT'L: 22 ga. sheet  
WEIGHT: 10 lbs. ea.

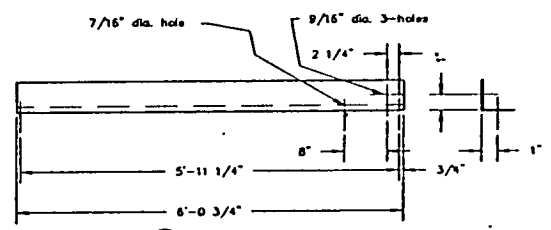

23 BRACE 1-REQ'D MAT'L: 2 x 2 x 1/8"  
WEIGHT: 10 lbs see note at 22

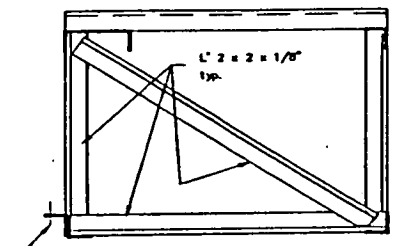
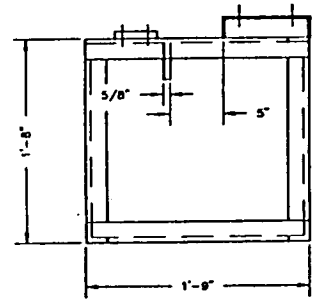
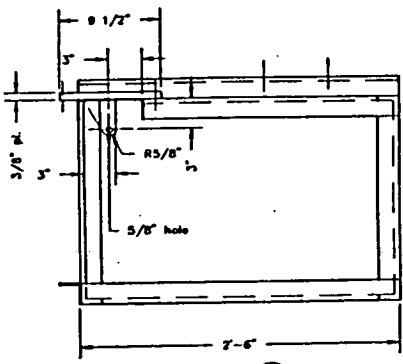

L' 2 x 2 x 1/8\"/>

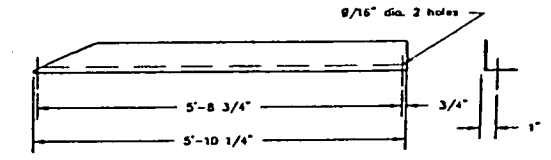

24 BRACE 1-REQ'D MAT'L L' 2 X 2 X 1/8"  
WEIGHT: 10 lbs see note at 22

|  |  |
|--|--|
|  | RECIPROCATING KILN INCINERATOR<br>INTEGRAL DRIVE SYSTEM<br>( FULLY AIR PORTABLE )<br>DRIVE SUPPORT FRAME DETAILS |
|  | ENVIRONMENTAL EMERGENCY BRANCH E.P.S.  |
|  | 416 - 6 - D 2  |
|  | TRECAN LIMITED<br>10000 100th Ave. S.E.<br>Bellevue, WA 98006  |

Revisions Date By

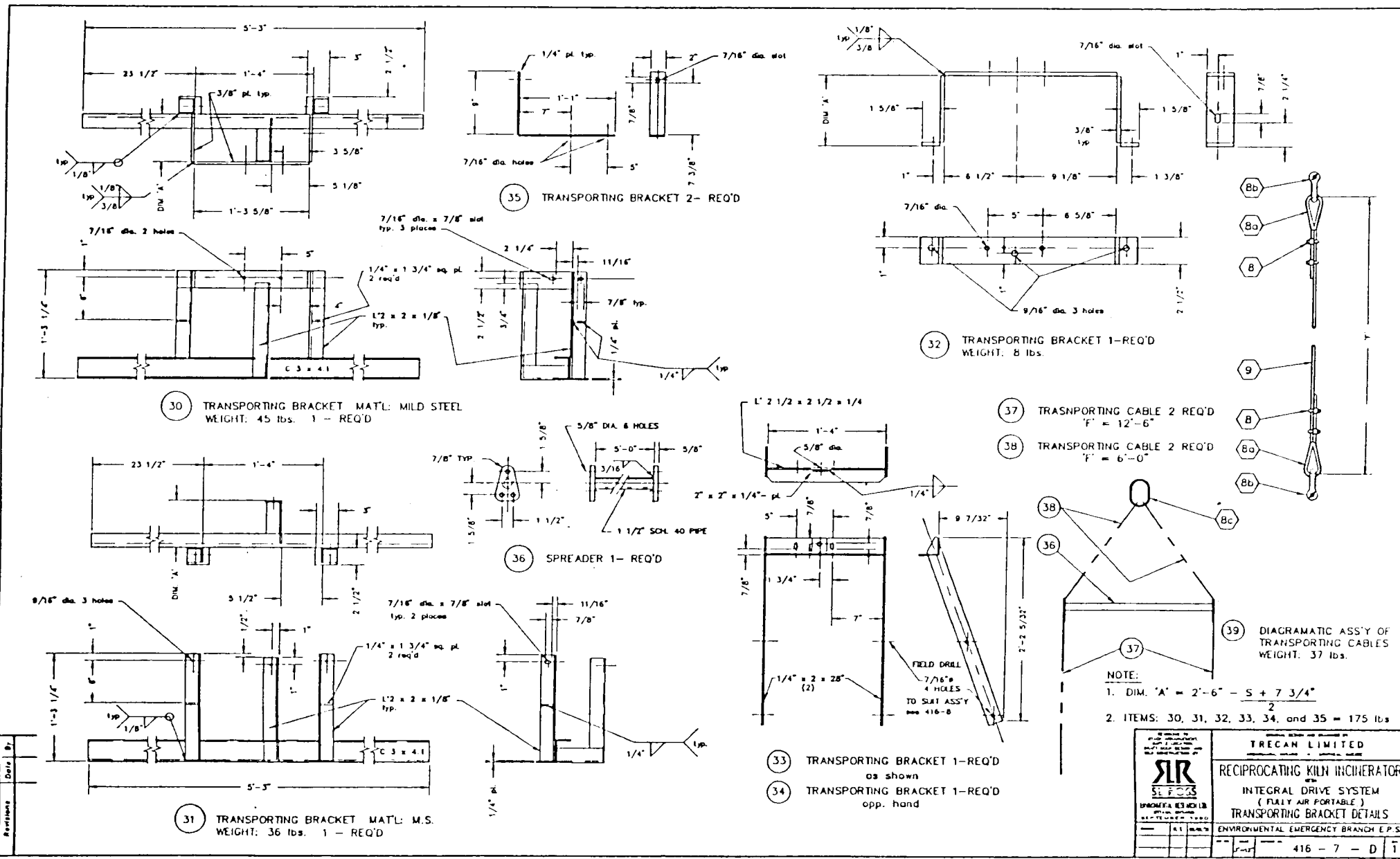

Revisions  
Date

|                                       |  |   |  |
|---------------------------------------|--|---|--|
|                                       |  | TRECAN LIMITED  |  |
|                                       |  | RECIPROCATING KILN INCINERATOR<br>INTEGRAL DRIVE SYSTEM<br>( FULLY AIR PORTABLE )<br>TRANSPORTING BRACKET DETAILS |  |
| ENVIRONMENTAL EMERGENCY BRANCH E.P.S. |  | 416 - 7 - D 1   |  |

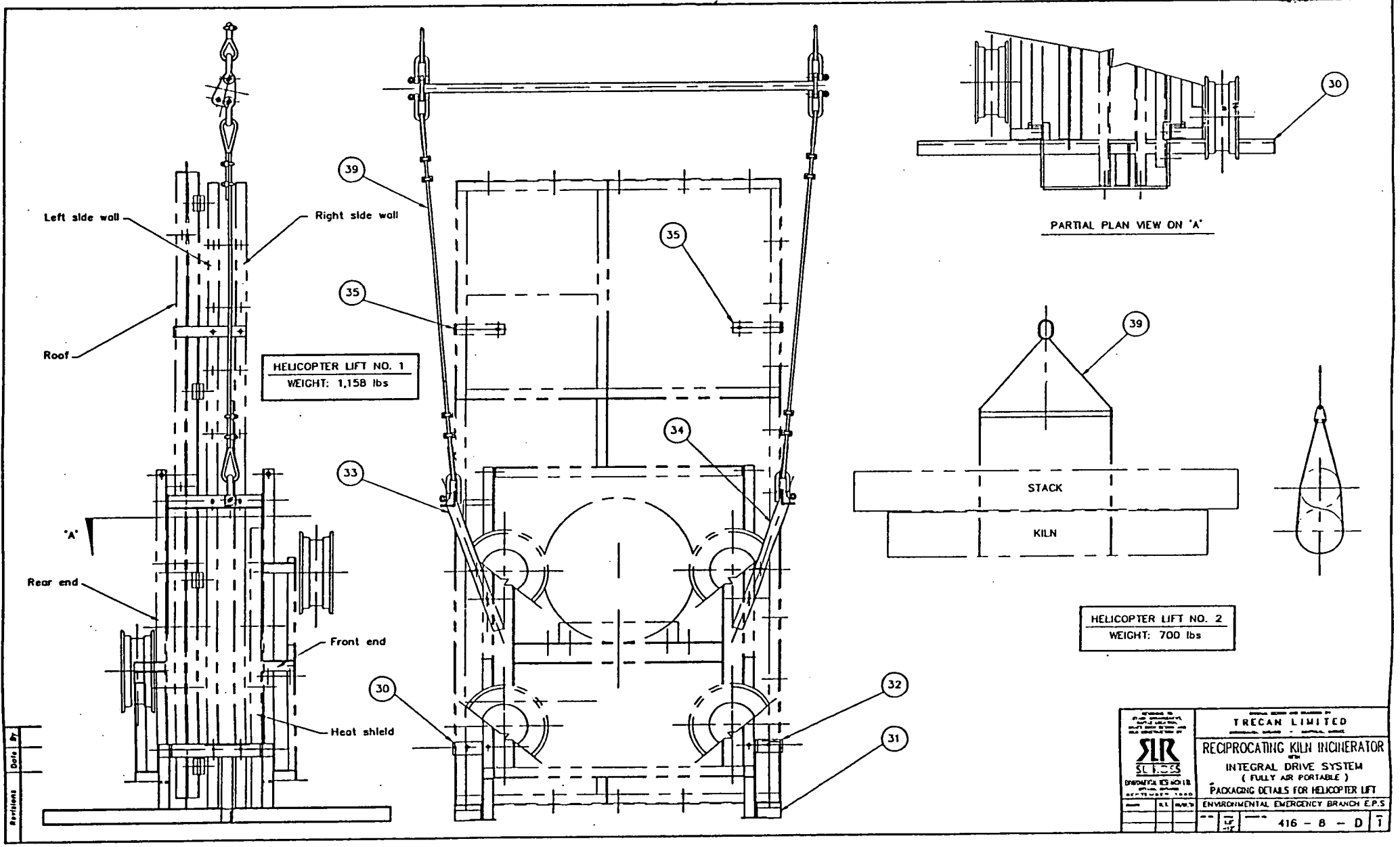

HELICOPTER LIFT NO. 1  
WEIGHT: 1,158 lbs

HELICOPTER LIFT NO. 2  
WEIGHT: 700 lbs

|  |  |                            |
|--|--|----------------------------|
| <small>DESIGNED BY</small><br><small>ENGINEER</small><br><small>DATE</small><br><small>SCALE</small><br><small>PROJECT NO.</small><br><small>REVISED BY</small><br><small>DATE</small><br><small>REVISIONS</small> | <b>TRECAN LIMITED</b><br>RECIPROCATING KILN INCINERATOR<br>with<br>INTEGRAL DRIVE SYSTEM<br>( FULLY AIR PORTABLE )<br>PACKAGING DETAILS FOR HELICOPTER LIFT<br>ENVIRONMENTAL EMERGENCY BRANCH E.P.S. |                            |
|  |  | 416 - 8 - D 1              |
|  | <small>ENVIRONMENTAL EMERGENCY BRANCH E.P.S.</small>   | <small>DATE</small>        |
|  | <small>SCALE</small>   | <small>PROJECT NO.</small> |

MATERIAL LIST  
RECIPROCATING KILN

| Item No. | Qty.  | DESCRIPTION   |
|----------|-------|---|
|          |       | <u>Drawing Ref. TDL-416-A</u>   |
| 1        | 1     | Lister Petter Diesel Engine   |
| 2        | 1     | Shaft mounted speed reducer with torque-arm and 2" I.D. bushing for shaft mounting, with 1/2" x 1/4" Keyway.<br>Sala TV53C (65.65:1 Ratio) (David Brown Gear Industries.) |
| 3        | 2     | Pillow blocks, SKF SY-200   |
| 4        | 1     | V-Belt Sheave, SKF 1B94SDS c/w taper bushing with 3/4" Bore and 3/16" x 3/32" Keyway.   |
| 5        | 1     | V-Belt Sheave, SKF 1B40SH c/w taper bushing with 1 11/16" dia. Bore.  |
| 6        | 1     | V-Belt A51.   |
| 7a       | 1     | Taper lock weld-on hub, Dodge W25.  |
| 7b       | 1     | Taper lock bushing, Dodge No. 2517 with 2" Bore and 1/2" x 1/4" Keyway.   |
| 8        | 22    | U-Bolt wire rope clips to suit item 9 - only 2 included.  |
| 8a       | 8     | Wire rope thimbles to suit item 9 - not included.   |
| 8b       | 8     | Wire rope shackle 1 1/2 ton capacity (Crosby G210) - not included.  |
| 8c       | 1     | Weldless Alloy Master Link, 5/8" Rod Dia. (Crosby A342) - not included.   |
| 9        | 28.6m | Wire rope 5/16" Dia. (Min.) - 2 cable @ 44' ea. (13.4m), weight 10 lbs.   |
| 10       | 6     | Second hand automotive front wheel axles complete with bearings, hub and wheel. Wheels not less than 15" O.D.<br>NOTE: Wheels have to be identical pairs.                 |
| 11       | 1     | As Item 10 but without wheel (with hub and nuts).   |
| 12       | 1     | Automotive steering tie rod end. (Not from A Minigar.)  |
| 13       | 9     | Fibreglass batting 2" x 4" x 30" or equivalent.   |
| 14       | 61m   | Wire, 9 Ga  |

| Item No. | Qty. | DESCRIPTION   |
|----------|------|---|
|          |      | <p><u>LIST OF BOLTS AN SHOWN ON DRAWING 416-1-D</u></p> <p>31      81      Hexagon HD bolt and nut, 3/8 - 16 UNC x 3/4" Long.</p> <p>32      24      Hexagon HD bolt c/w two nuts, 1/2 - 13 UNC x 1 1/2" Long.<br/>(Items 31 and 32: 50% allowed for loss at assembly).</p> <p>33      4      Hexagon HD bolt c/w two nuts, 5/8 - 11 UNC x 2" Long.</p> <p>34      4      Hexagon HD bolt c/w two nuts, 3/8 - 16 UNC x 3" Long.</p> <p>35      4      Hexagon HD bolt and nut, 1/2 - 13 UNC x 5" Long.<br/>(2 allowed for loss at assembly).</p> <p>36      25      Spare hexagon HD bolt and nut, 3/8 - 16 UNC x 1 1/2" Long.<br/>To be used at assembly if necessary after secondary chamber is fired and by relocation some distortion renders item 31 too short to start nut.</p> |
|          |      |   |

**APPENDIX C**  
**STACK EMISSIONS DATA**



**Summary of CEM Data  
for the  
Shoreline Incinerator Tests  
- November 1991 -**

### Raw CEM Concentration Data

| Test   | Concentrations |              |             |                 |           |            |
|--------|----------------|--------------|-------------|-----------------|-----------|------------|
|        | SO2<br>(ppm)   | NOx<br>(ppm) | CO<br>(ppm) | THC(h)<br>(ppm) | O2<br>(%) | CO2<br>(%) |
| Part 1 | 9              | 20           | 976         | 318             | 17.3      | 2.88       |
| Part 2 | 11             | 27           | 1066        | 280             | 16.7      | 3.44       |
| Org 1  | 18             | 25           | 1194        | 352             | 17.4      | 2.95       |
| Org 2  | 17             | 24           | 1317        | 398             | 17.5      | 2.88       |
| Org 3  | 15             | 28           | 1208        | 512             | 17.6      | 2.90       |

### Corrected Concentration Data

| Test   | Concentrations at 11% oxygen |              |             |                 |
|--------|------------------------------|--------------|-------------|-----------------|
|        | SO2<br>(ppm)                 | NOx<br>(ppm) | CO<br>(ppm) | THC(h)<br>(ppm) |
| Part 1 | 25                           | 55           | 2684        | 875             |
| Part 2 | 26                           | 64           | 2513        | 660             |
| Org 1  | 51                           | 71           | 3377        | 996             |
| Org 2  | 52                           | 70           | 3835        | 1159            |
| Org 3  | 45                           | 84           | 3624        | 1536            |

**Summary of CEM Data**  
**- Raw and Corrected to 11% O<sub>2</sub> -**

Stack Gas Data  
- Graphical -

**Particulate Runs 1 & 2  
Continuous Emission Monitor Data**

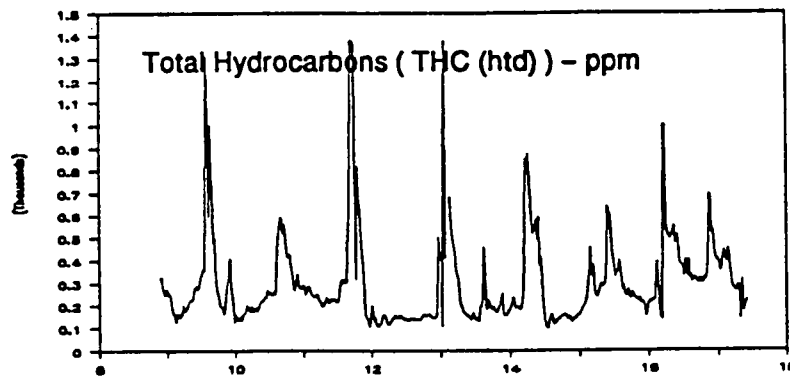
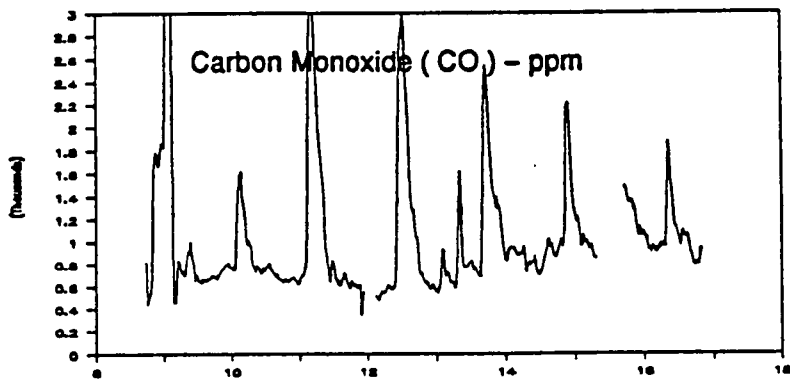
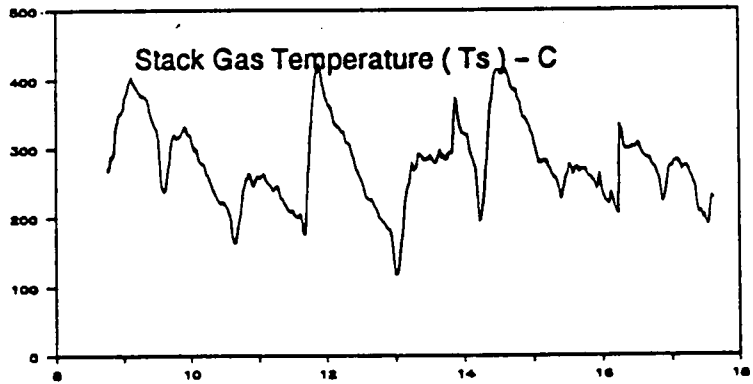

Clock time ( 24 hr )



# Particulate Runs 1 & 2 Continuous Emission Monitor Data

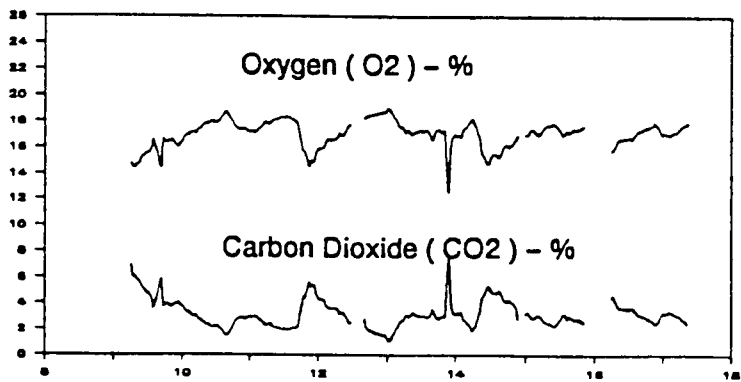
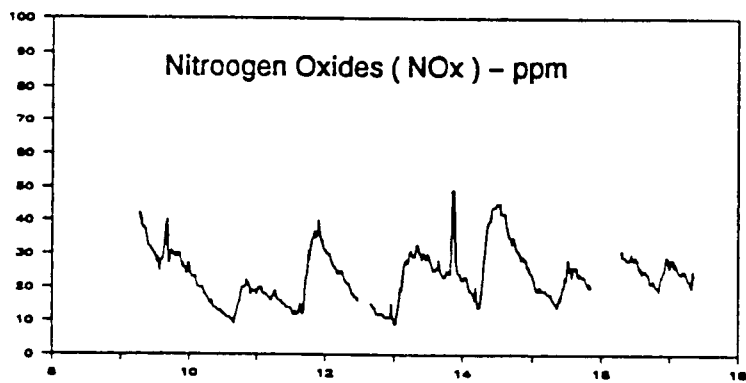
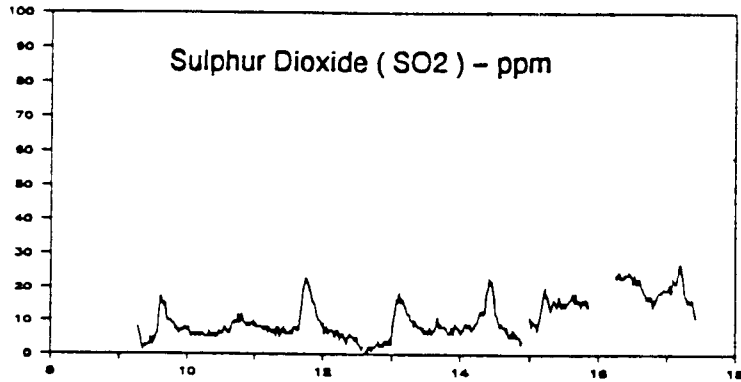

Clock time ( 24 hr )

# Organic Runs 1 & 2 Continuous Emission Monitor Data

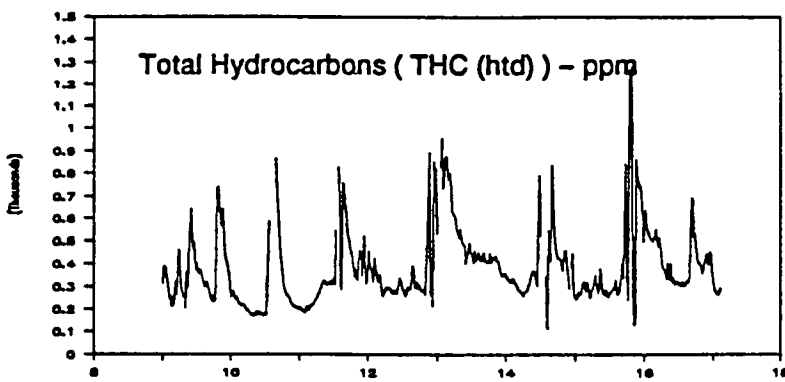
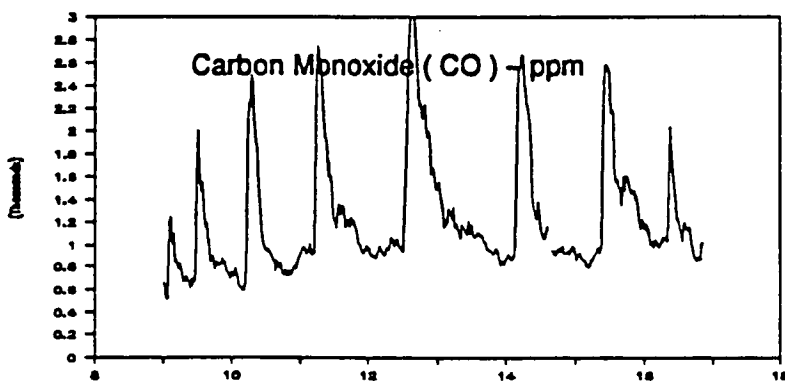
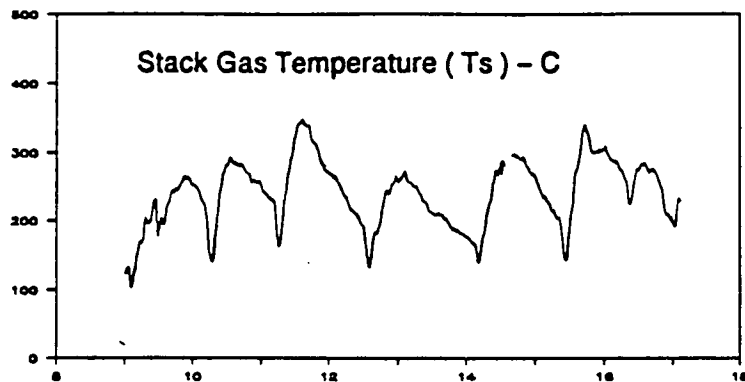

Clock time ( 24 hr )

# Organic Runs 1 & 2 Continuous Emission Monitor Data

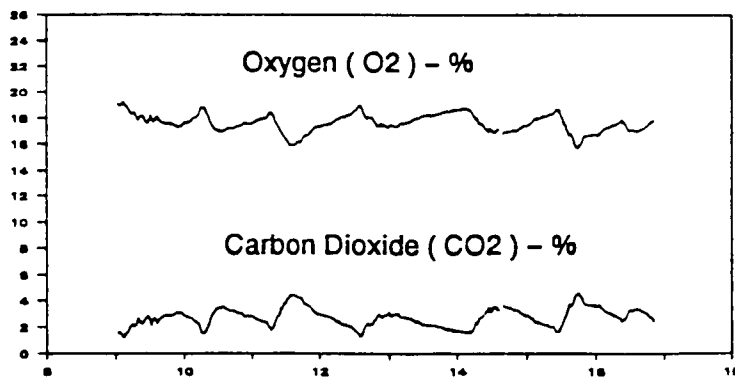
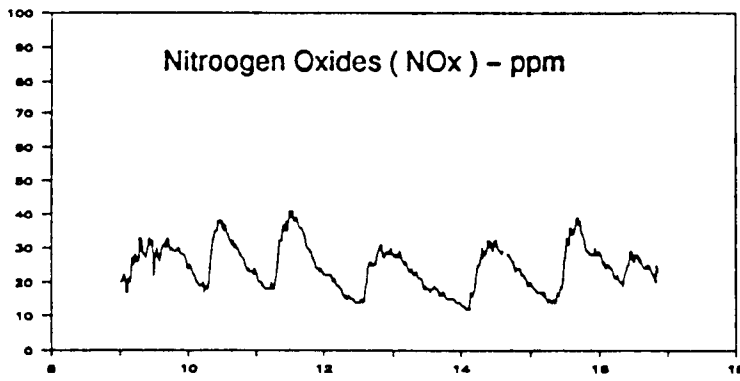
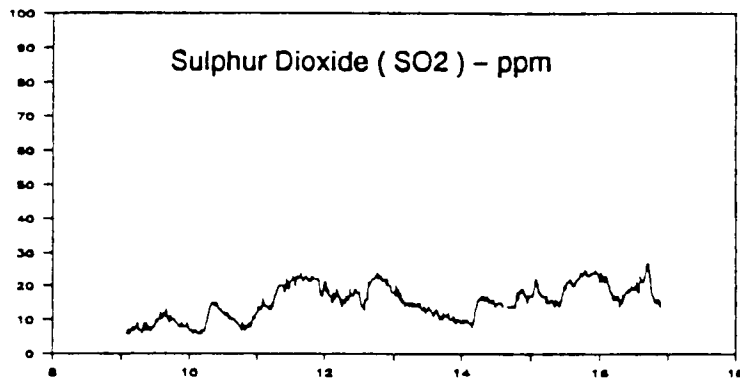

Clock time ( 24 hr )



# Organic Run 3 Continuous Emission Monitor Data

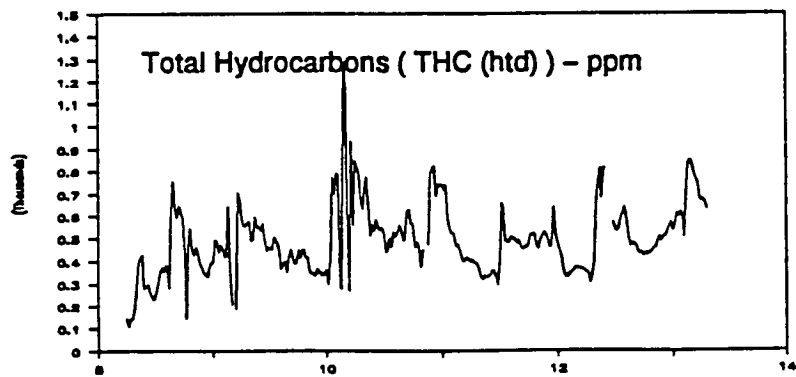
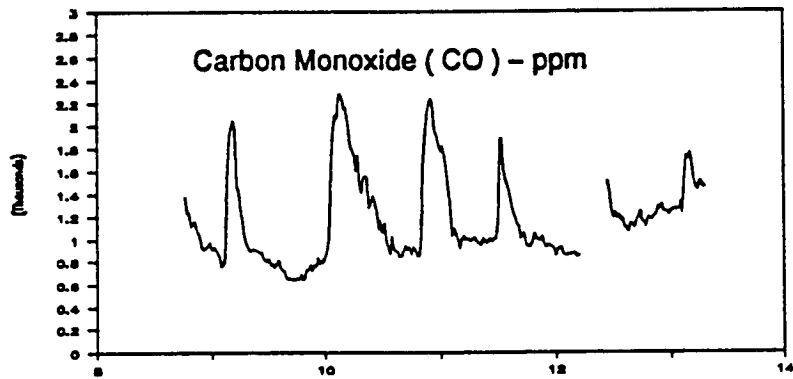
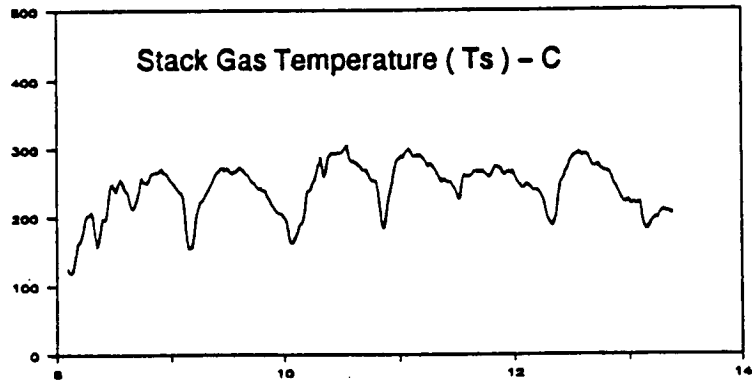

Clock time ( 24 hr )

# Organic Run 3 Continuous Emission Monitor Data

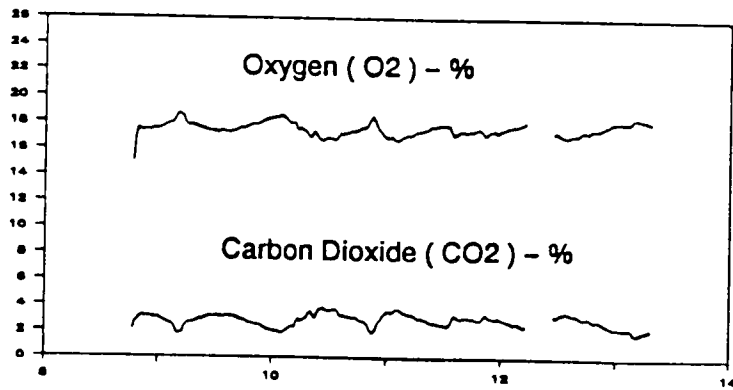
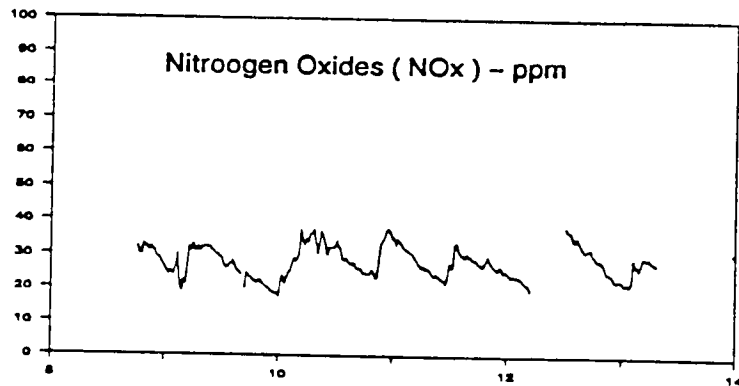
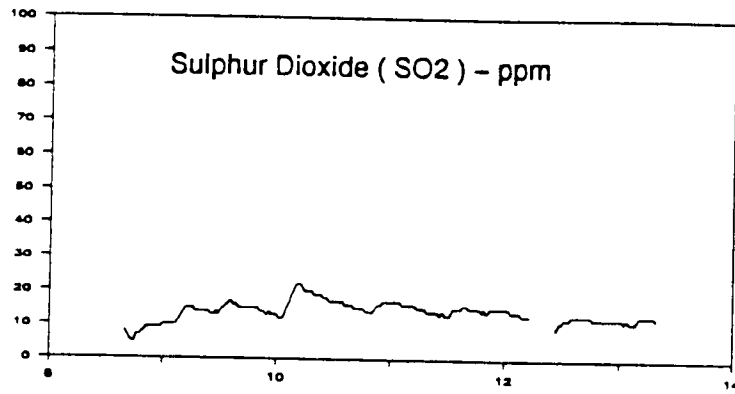

Clock time ( 24 hr )

**TABLE 1 - SUMMARY of PARTICULATE EMISSIONS**

| Run Number                         | PART #1      | PART #2      |
|------------------------------------|--------------|--------------|
| <b>GENERAL INFORMATION</b>         |              |              |
| Date                               | Nov 13, 1991 | Nov 13, 1991 |
| Test Duration (min)                | 96           | 96           |
| Sample Volume (m <sup>3</sup> )    | 2.062        | 2.052        |
| Isokineticity (%)                  | 96.1         | 98.2         |
| <b>STACK GAS CHARACTERISTICS</b>   |              |              |
| Actual Velocity (m/s)              | 5.67         | 5.84         |
| Flowrate (m <sup>3</sup> /min)     | 45.2         | 44.4         |
| Temperature (°C)                   | 263.9        | 290.1        |
| Moisture (%)                       | 6.07         | 5.89         |
| Oxygen (%)                         | 17.29        | 16.71        |
| Carbon Dioxide (%)                 | 2.88         | 3.44         |
| <b>EMISSION RESULTS</b>            |              |              |
| Concentration (mg/m <sup>3</sup> ) |              |              |
| Uncorrected                        | 280.3        | 191.5        |
| Corrected (@11 %O <sub>2</sub> )   | 768.7        | 452.5        |
| Emission Rate (kg/day)             | 18.24        | 12.25        |

Gas volumes are reported on a dry basis referenced to 25 °C and 101.3 kPa

**TABLE 2 - SUMMARY of VOC EMISSIONS ( $\mu\text{g}/\text{m}^3$  @11%  $\text{O}_2$ )**

| COMPOUND                      | VOC #1         | VOC #2         |
|-------------------------------|----------------|----------------|
| 1-Propene                     | 58204          | 55017          |
| Propane                       | 5050           | 5640           |
| Propyne                       | 11023          | 8587           |
| 1-Butene                      | 3853           | 4982           |
| 1,3-Butadiene                 | 47             | 1846           |
| 1-Pentene                     | 490            | 1054           |
| 2-Methyl-2-butene             | 531            | 1202           |
| 2-Methylpentane               | 314            | 1653           |
| 1-Hexene                      | 611            | 1233           |
| n-Hexane                      | 1138           | 2204           |
| Methylcyclopentane            | 146            | 1104           |
| Benzene                       | 36359          | 25305          |
| Cyclohexane                   | 16             | 1014           |
| 2-Methylhexane                | 26             | 1164           |
| 3-Methylhexane                | 19             | 1283           |
| 1-Heptene                     | 380            | 1637           |
| Heptane                       | 77             | 3489           |
| Methylcyclohexane             | 87             | 5503           |
| Toluene                       | 13634          | 10513          |
| 2-Methylheptane               | 52             | 1477           |
| cis-1,3-Dimethylcyclohexane   | 77             | 2043           |
| trans-1,4-Dimethylcyclohexane | 225            | 5519           |
| Octane                        | 187            | 5170           |
| trans-1,2-Dimethylcyclohexane | 105            | 1866           |
| Ethylbenzene                  | 1366           | 1788           |
| m,p-Xylene                    | 1672           | 3426           |
| Styrene                       | 165            | 1501           |
| o-Xylene                      | 664            | 1244           |
| n-Nonane                      | 140            | 5743           |
| 1,2,4-Trimethylbenzene        | 263            | 1403           |
| Decane                        | 234            | 4636           |
| Dodecane                      | 1594           | 1650           |
| <b>TOTAL</b>                  | <b>138,749</b> | <b>171,896</b> |

**TABLE 1 - SUMMARY of PAH EMISSIONS**

| Run Number                         | PAH #1       | PAH #2       |
|------------------------------------|--------------|--------------|
| <b>GENERAL INFORMATION</b>         |              |              |
| Date                               | Nov 14, 1991 | Nov 15, 1991 |
| Test Duration (min)                | 140          | 192          |
| Sample Volume (m <sup>3</sup> )    | 3.076        | 3.076        |
| Isokineticity (%)                  | 97.2         | 98.1         |
| <b>STACK GAS CHARACTERISTICS</b>   |              |              |
| Actual Velocity (m/s)              | 5.88         | 5.19         |
| Flowrate (m <sup>3</sup> /min)     | 45.8         | 43.4         |
| Temperature (°C)                   | 274.8        | 243.8        |
| Moisture (%)                       | 5.83         | 5.88         |
| Oxygen (%)                         | 17.53        | 17.56        |
| Carbon Dioxide (%)                 | 2.88         | 2.90         |
| <b>EMISSION RESULTS</b>            |              |              |
| Concentration (ug/m <sup>3</sup> ) |              |              |
| Uncorrected                        | 2173         | 801          |
| Corrected (@11 %O <sub>2</sub> )   | 6385         | 2373         |
| Emission Rate (g/day)              | 143          | 50           |

Gas volumes are reported on a dry basis referenced to 25 °C and 101.3 kPa

**TABLE 2 - SUMMARY of PAH EMISSIONS ( $\mu\text{g}/\text{m}^3$  @11% O<sub>2</sub>)**

|   | PAH #1  | PAH #2  |
|---|---------|---------|
| Acenaphthylene  | 1134.72 | 353.72  |
| Acenaphthene  | 61.89   | 29.68   |
| Fluorene  | 327.63  | 144.56  |
| 2-Methyl-Fluorene   | ND      | ND      |
| Phenanthrene  | 1806.99 | 821.46  |
| Anthracene  | 205.63  | 71.93   |
| Fluoranthene  | 769.94  | 271.55  |
| Pyrene  | 657.80  | 234.11  |
| Benzo(a)Fluorene  | 151.34  | 49.51   |
| Benzo(b)Fluorene  | 89.48   | 25.10   |
| 1-Methyl-Pyrene   | 93.06   | 28.95   |
| Benzo(g,h,i)Fluoranthene  | 31.38   | 46.62   |
| Benzo(a)Anthracene  | 192.85  | 53.83   |
| Chrysene & Triphenylene   | 200.54  | 65.39   |
| 7-Methyl-Benzo(a)Anthracene                                       | ND      | ND      |
| Benzo(b&k)Fluoranthene  | 205.74  | 66.65   |
| Benzo(e)Pyrene  | 78.45   | 25.79   |
| Benzo(a)Pyrene  | 114.86  | 31.84   |
| Perylene  | 20.04   | 6.72    |
| 3-Methyl-Cholanthrene   | ND      | ND      |
| Indeno(1,2,3-cd)Pyrene  | 73.93   | 24.74   |
| Dibenzo(a,c)&(a,h)Anthracene                                      | ND      | ND      |
| Benzo(b)Chrysene  | ND      | 0.31    |
| Benzo(g,h,i)Perylene  | 56.26   | 18.69   |
| Anthanthrene  | 12.31   | 1.71    |
| Total Corrected ( $\mu\text{g}/\text{m}^3$ @ 11% O <sub>2</sub> ) | 6384.83 | 2372.85 |

ND denotes values below the detection limit of approximately  $1.5 \mu\text{g}/\text{m}^3$  @ 11% O<sub>2</sub>

## PAH ANALYTICAL REPORT

Total ug

Project: Shoreline Incinerator

Sample Type: Train

Date: 02/03/92

| Sample ID     | TS-BL | TS-    | TS-2  | TS-2A | TS-3  | TS-3A |
|---------------|-------|--------|-------|-------|-------|-------|
| Sample type   | XAD   | Method | Front | Back  | Front | Back  |
|               | Blank | Blank  | Half  | Half  | Half  | Half  |
| AL            | -     | -      | 0.02  | 1188  | 0.09  | 367   |
| AE            | -     | -      | -     | 64.8  | -     | 30.8  |
| FL            | 0.02  | -      | 0.02  | 343   | 0.02  | 150   |
| MFL           | 0.13  | -      | -     | -     | -     | -     |
| PHE           | 0.13  | -      | 1.87  | 1890  | 0.50  | 852   |
| AN            | -     | -      | 0.29  | 215   | 0.05  | 74.6  |
| FLT           | 0.10  | -      | 12.1  | 794   | 2.81  | 279   |
| PY            | 0.08  | -      | 12.7  | 676   | 2.96  | 240   |
| B(a)FL        | 0.02  | -      | 4.45  | 154   | 0.88  | 50.5  |
| B(b)FL        | -     | -      | 2.58  | 91.1  | 0.45  | 25.6  |
| MPY           | -     | -      | 2.73  | 94.7  | 0.54  | 29.5  |
| B(ghi)F       | 0.03  | -      | 5.55  | 132   | 1.18  | 47.2  |
| B(a)A         | 0.04  | -      | 9.91  | 192   | 1.86  | 54.0  |
| C&T           | 0.06  | -      | 9.96  | 200   | 2.36  | 65.5  |
| MB(a)A        | -     | -      | -     | -     | -     | -     |
| B(b)F & B(k)F | 0.07  | -      | 14.4  | 201   | 3.17  | 66.0  |
| B(e)P         | 0.03  | -      | 6.43  | 75.7  | 1.56  | 25.2  |
| B(a)P         | 0.03  | -      | 8.25  | 112   | 1.74  | 31.3  |
| PER           | -     | -      | 1.68  | 19.3  | 0.37  | 6.60  |
| MCH           | -     | -      | -     | -     | -     | -     |
| IP            | 0.02  | -      | 14.0  | 63.4  | 4.18  | 21.5  |
| D(ah)A        | -     | -      | -     | -     | -     | -     |
| B(b)C         | -     | -      | -     | -     | 0.32  | -     |
| B(ghi)P       | 0.02  | -      | 11.8  | 47.1  | 4.00  | 15.4  |
| ANT           | -     | -      | 2.79  | 10.1  | 0.54  | 1.27  |
| Total PAH     | 0.78  |        | 122   | 6563  | 29.6  | 2433  |

## Recovery %

|             |     |    |    |      |    |      |
|-------------|-----|----|----|------|----|------|
| d10-AE      | 38  | 13 | 33 | 166* | 20 | 140* |
| d10-AN      | 40  | 29 | 52 | 39   | 25 | 83   |
| d10-PY      | 84  | 36 | 71 | 145* | 37 | 79   |
| d12-B(a)A   | 93  | 40 | 84 | 85   | 40 | 85   |
| d12-B(a)P   | 51  | 41 | 72 | 16   | 36 | 66   |
| d14-D(ah)A  | 110 | 48 | 98 | 84   | 46 | 110  |
| d12-B(ghi)P | 101 | 45 | 61 | -    | 31 | 49   |

Note: (1) "-" denotes values below detection limit of  
0.01-0.02 ug/sample/analyte peak for TS-BL, TS-Meth Bl, TS-2,  
TS-3; 0.5-1.0 for TS-3A; 1.0-2.0 for TS-2A.

(2) \* High results due to interferences.



*This publication is printed on paper containing recovered waste.*