Environmental
Studies
Research
Funds

- 120 Development and Testing
of a Prototype Rock Washer
for Cleaning Oiled Beach Cobble

The Environmental Studies Research Funds are financed from special levies on the oil and gas industry and are administered by the National Energy Board for the Minister of Energy, Mines and Resources, and for the Minister of Indian Affairs and Northern Development.

The Environmental Studies Research Funds and any person acting on their behalf assume no liability arising from the use of the information contained in this document. The opinions expressed are those of the authors and do not necessarily reflect those of the Environmental Studies Research Funds agencies. The use of trade names or identification of specific products does not constitute an endorsement or recommendation for use.

ENVIRONMENTAL STUDIES RESEARCH FUNDS

Report No. 120

January 1991

**DEVELOPMENT AND TESTING OF A PROTOTYPE
ROCK WASHER FOR CLEANING
OILED BEACH COBBLE**

**S.L. ROSS ENVIRONMENTAL RESEARCH LIMITED
OTTAWA, ONTARIO**

Scientific Authority: Mr. Gary Sergy

The correct citation for this report is:

C. Guénette. 1991. Development and testing of a prototype rock washer for cleaning oiled beach cobble. Environmental Studies Research Funds Report No. 120. Calgary. 45p.

**Published under the auspices of the
Environmental Studies Research Funds
ISBN 0-921652-21-6
1991 S.L. Ross Environmental Research Limited**

ABSTRACT

A full-scale prototype cobble washer was tested in early September 1990 at a site in Woodlawn, Ontario near Ottawa. This prototype was designed to be used on remote beaches consisting of cobble, boulder and mixed type sediment. Several criteria including feed material size, simplicity, heli-portability, throughput and power requirements had been set and were met by this prototype.

The following beach sediment and oil types were used in this study: mixed sediment, gravel and cobble oiled with fresh, weathered and emulsified crude and Bunker A, at oil loadings of 0.25 to 2.0% by weight. This study demonstrated the capability of the prototype to effectively clean contaminated beach sediment. Cleaned beach sediment contained 0.00 to 0.02% oil. Cold water washing was adequate for most oil/sediment combinations except those with Bunker A. Bunker A/sediment combinations required hot water washing and usually a second pass through the rock washer. Throughput rates of over 16 tonnes/hour were achieved with this prototype.

RÉSUMÉ

Un prototype grandeur réelle de laveuse de cailloux a été mis à l'essai en septembre à Woodland (Ontario), près d'Ottawa. Ce prototype a été conçu en vue d'être utilisé sur des plages éloignées composées de cailloux, de blocs et de sédiments de type mélangé. Plusieurs critères, concernant notamment la taille des matières d'alimentation, la simplicité, l'héliportabilité, le débit et les exigences en matière d'énergie, avaient été établis et ce prototype y a satisfait.

Les types suivants de sédiments de plage et d'huiles ont été utilisés dans cette étude : sédiments mélangés, gravier et cailloux avec de l'huile brute et du fuel de soute de catégorie A frais, altérés et émulsionnés, à des concentrations d'huile en poids de 0,25 à 2,0 %. L'étude a démontré la capacité du prototype de nettoyer efficacement des sédiments de plage contaminés. Les sédiments de plage nettoyés contenaient de 0,00 à 0,02 % d'huile. Le lavage à l'eau froide était efficace pour la plupart des combinaisons huile/sédiment, sauf les combinaisons avec le fuel de soute A. Les combinaisons fuel de soute A/sédiment nécessitaient un lavage à l'eau chaude et généralement un deuxième passage dans la laveuse de roches. Des débits supérieurs à 16 tonnes/heure ont été réalisés avec ce prototype.

ACKNOWLEDGEMENTS

This project, to develop and test a prototype beach cleaner, was performed under contract to the Emergencies Engineering Division (EED) of Environment Canada by S.L. Ross Environmental Research Limited. The author of this report was Ms. Chantal Gu nette of S.L. Ross Environmental Research Limited.

The funding for this project was supplied by the Environmental Studies Research Fund and the River Road Environmental Technology Centre. Mr. Gary Sergy of the Emergencies Sciences Division (ESD) was the scientific authority for this project. Thanks are extended to EED River Road laboratories for performing the laboratory analysis and for supplying the oils used for testing.

TABLE OF CONTENTS

	<u>PAGE</u>
1.0 INTRODUCTION	1
1.1 Objectives	1
1.2 Goals	1
2.0 STATE-OF-THE-ART REVIEW	2
2.1 Mobile Plant Prototype (CEDRE, IFP, and LCPC Developments)	2
2.2 Homer Gravel Washer	9
2.3 Northwest Processing Inc. Beach Cleaning Systems	9
2.4 A.J. Oily Waste Wash Plant	10
2.5 Summary	13
3.0 PROTOTYPE DESIGN	15
3.1 Design Criteria	15
3.2 Bench Scale Test	16
3.2.1 Methodology and Test Matrix	16
3.2.2 Observations	17
3.3 Prototype Design	18
4.0 TEST SITE, MATERIALS & EQUIPMENT	21
4.1 Test Site and Site Layout	21
4.2 Test Materials	21
4.2.1 Test Oils	21
4.2.2 Test Sediment	23
4.3 Test Matrix	24

TABLE OF CONTENTS

	<u>PAGE</u>
5.0 TEST PROCEDURES	25
5.1 Test Methodology	25
5.2 Sampling and Analysis	25
5.3 Data Collection	29
6.0 RESULTS AND DISCUSSION	30
6.1 Output Oil	30
6.1.1 Quantitative Analysis	38
6.1.2 Qualitative Analysis	39
6.2 Separator Efficiency	40
6.3 Operating Conditions	42
7.0 CONCLUSIONS AND RECOMMENDATIONS	43
7.1 Conclusions	43
7.2 Recommendations	44
8.0 REFERENCES	45
APPENDIX A: Database for Cobble Washer and Related Technology	
APPENDIX B: Rock Washer User's Guide	
APPENDIX C: Rock Washer Blueprints and Equipment Specifications	

LIST OF FIGURES

<u>FIGURE</u>	<u>PAGE</u>
1 S.L. Ross bench-scale cobble washer	3
2 Percent removal vs. wash time	4
3 S.L. Ross mobile drum cleaner concept	5
4 Outline flowsheet of the mobile plant	7
5 Proposed secondary treatment flowsheet for Northwest Processing system	11
6 Northwest Processing beach cleaning system	11
7 A.J. Energy oily waste wash plant	12
8 Rock washer - general arrangement and piping schematic	20
9 Test site sketch	22
10 Test site layout	26
11 Rock washer test site	27
12 Test results as a function of rock size and oil type	32
13 Fresh crude with gravel	33
14 Weathered crude with cobble	34
15 Emulsified crude with mixed sediment	35
16 Bunker A with mixed sediment	36
17 API-type separator	41

LIST OF TABLES

<u>TABLE</u>	<u>PAGE</u>
1 Applicability of existing beach cleaners	14
2 Initial properties of test oils	23
3 Summary of Rock washer test results	31
4 Visual observations of washed rocks	37

1.0 INTRODUCTION

Over the last decade much effort has been given to the development of mechanical cleaning systems for contaminated sand beaches. However, an oil spill along Canada's shoreline is more likely to result in the contamination of rocky shorelines.

Few studies have been dedicated to the development of pebble, shingle or rocky shoreline cleanup devices. Recent spill events on Vancouver Island and in Prince William Sound, Alaska, have heightened awareness of the problems associated with cleaning gravel/cobble sediment beaches and resulted in renewed interest in washing techniques.

1.1 OBJECTIVES

The purpose of this study was to research, design, construct, and test a prototype moderate-capacity, heli-portable, stationary gravel/cobble washer. The objective was to develop a system that could wash oil off gravel/cobble that had an oil loading too low for the use of incineration or was inappropriate for placement in an incinerator.

1.2 GOALS

More specifically, the project was aimed at achieving the following goals:

- design and build a prototype with readily available materials (i.e., culvert, angle iron, etc.) to the greatest extent possible to permit easy, inexpensive construction of many units in the event of a spill; and
- design and build a prototype to meet set criteria of: feed material size, simplicity, mechanical reliability, heli-portability, safety, throughput, manual loading, power requirements, washwater/solvent requirements and recycling and oil separation.

2.0 STATE-OF-THE-ART REVIEW

S.L. Ross Environmental Research Limited, in a 1984 study for the oil industry's Canadian Offshore Oilspill Research Association (COOSRA), conducted a detailed survey of the coastline of Canada that identified predominant shoreline types, reviewed available information on shoreline oiling processes, reviewed the state-of-the-art in mechanical shoreline cleanup and identified gravel, cobble and mixed sediment beaches as a key Canadian shoreline type for which no mechanical cleanup systems existed. A gravel washing system was researched, a bench-scale prototype constructed (Figure 1) and tests conducted (Figure 2) with a range of oil types, washwater flows and pressures and sediment sizes (1 cm - 15 cm usually; one test used 25 - 30 cm cobbles). A heli-portable mobile full-scale cleaner (Figure 3) was conceptualized, including loading via small heli-portable 4WD tractors, washing, sediment redistribution, oil/water separation, etc. The system, as proposed, supported by several small 4WD tractors, could theoretically clean 22.5 tonnes per hour of gravel/cobble sediment (roughly equivalent to 100 man hours of manual sediment removal). Research on gravel/cobble beach trafficability, additional bench-scale testing, construction and testing of a full-scale prototype was proposed in 1984, but never funded.

The following is a review of available beach cleaning equipment developed since the 1984 COOSRA study.

2.1 MOBILE PLANT PROTOTYPE (CEDRE, IFP, AND LCPC DEVELOPMENTS)

A research program was undertaken in 1980 with support of the European Economic Community and the French Ministry of the Environment to develop a technique for treating oily beaches. The objective was to define a modular process which could be implemented mainly with available and easily transportable equipment and which would be able to wash polluted sands of variable grain-size distribution at different stages of weathering. As little work had been done in this matter, CEDRE (Centre de Documentation de Recherche et d'Expérimentations sur les Pollutions Accidentelles des Eaux), IFP (Institut Français du Pétrole), and the Laboratoire Central des Ponts et Chaussées were asked by the French authorities to evaluate beach cleanup techniques.

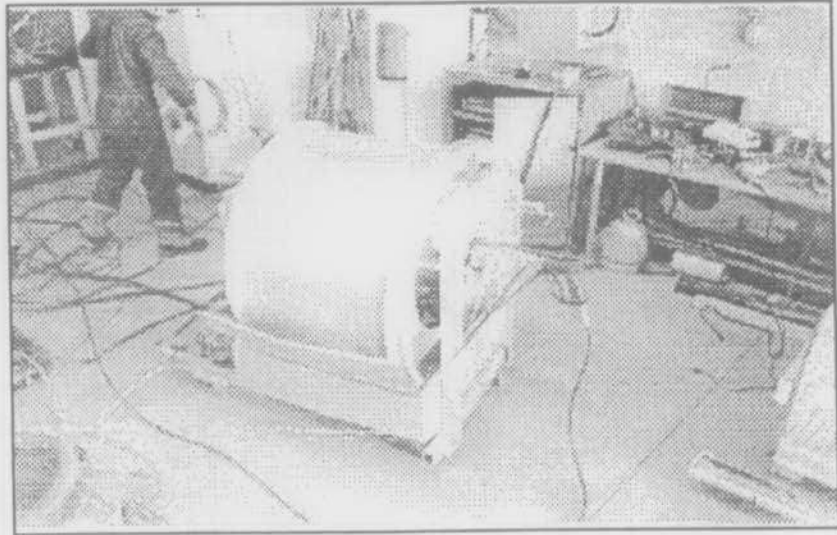

a) Rotary Porous Drum



b) Inside view showing rock and water nozzle

Figure 1: S.L. Ross bench-scale cobble washer

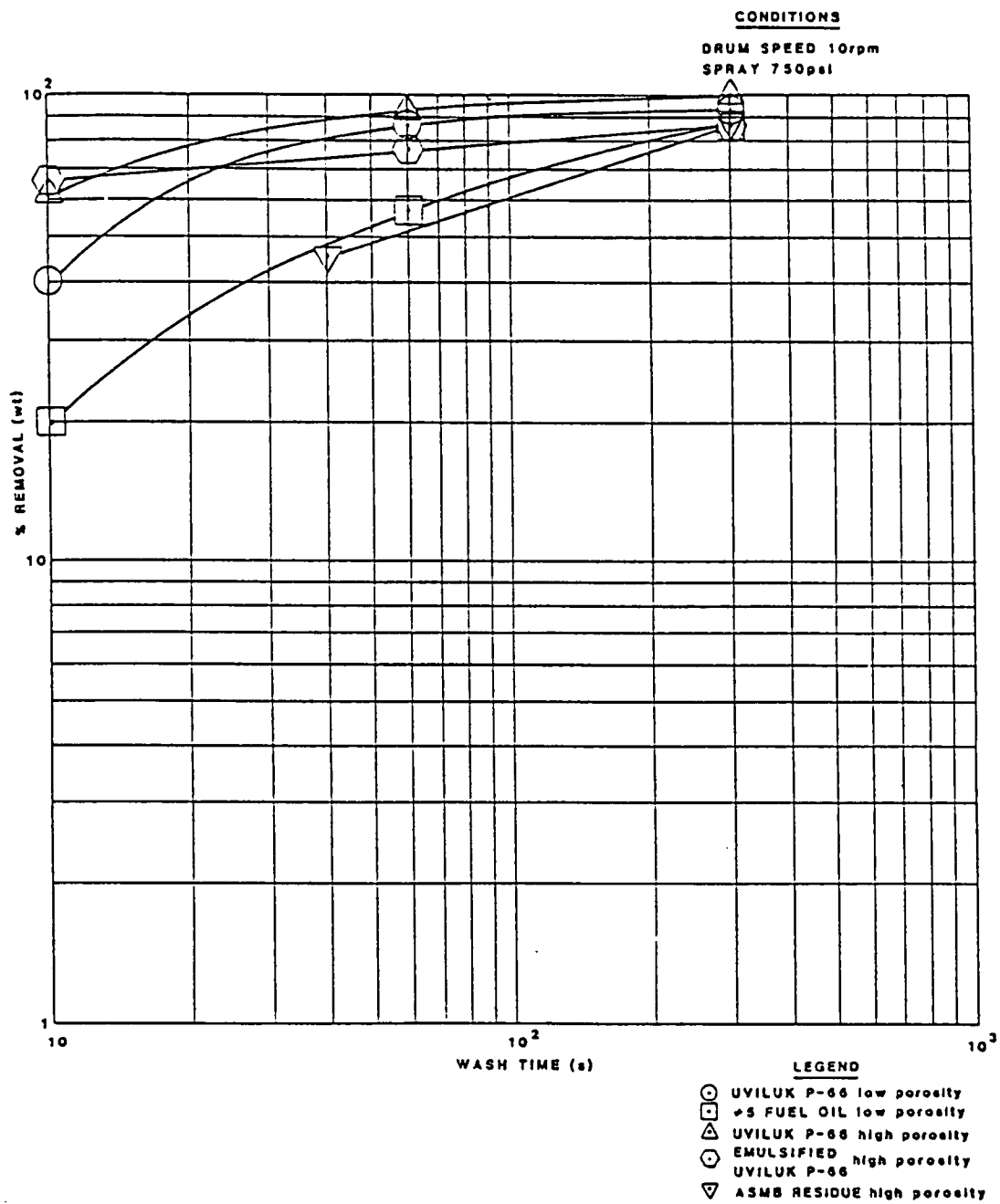
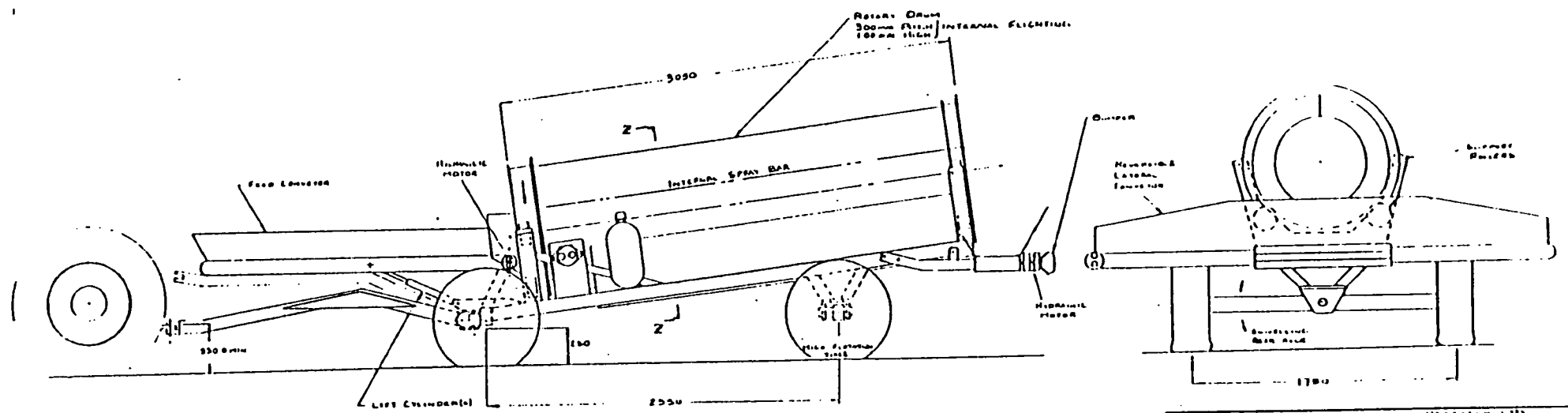
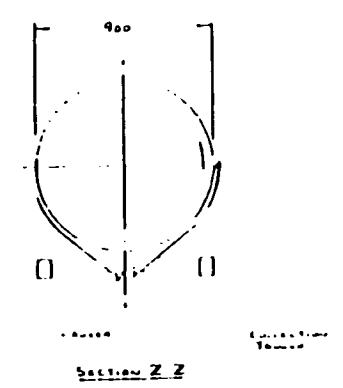
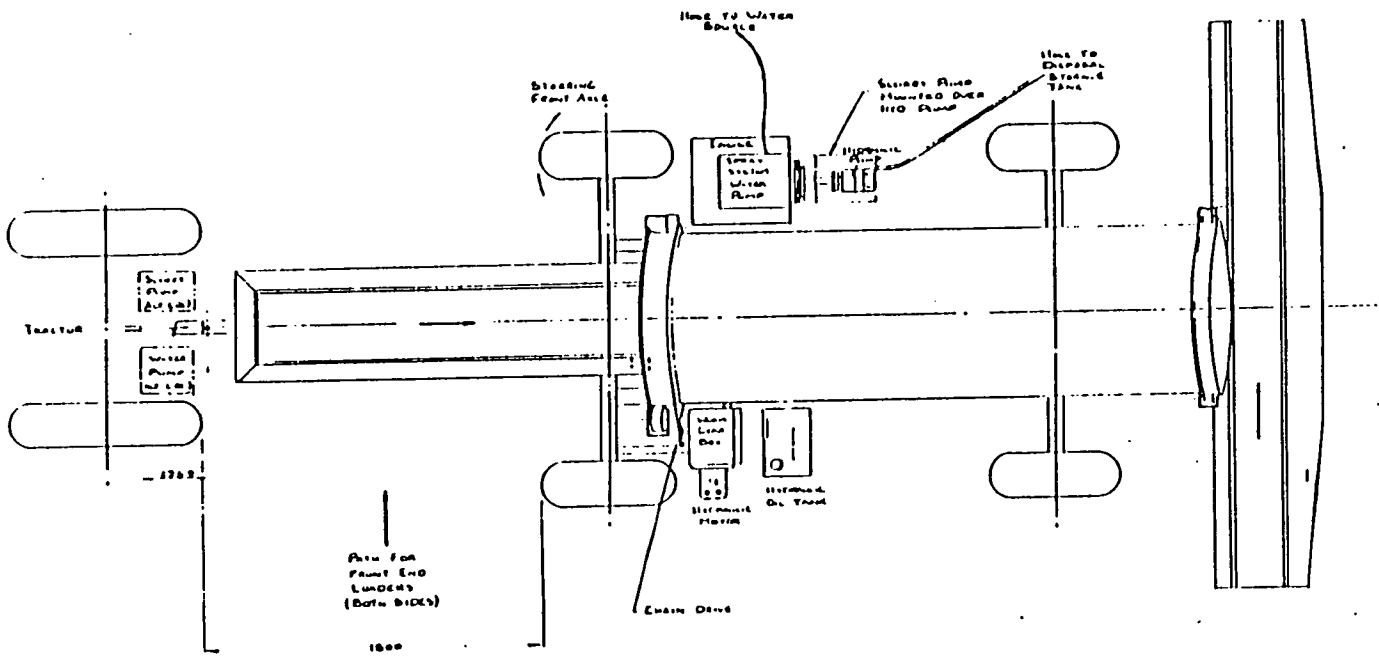

Figure 2: Percent removal vs. wash time



TOLERANCES UNLESS SHOWN	SA RULL ENGINEERING, NEWBURN L116 265 BRANK BECKER DRIVE, NEWBURN		
DESIGN FILED	DATE	DRAWN BY	
1		1/10	11/11/11
APPROVED	TITLE HORSE DRUM CLEANER CONCEPT DRAWING		
APPROVAL	DATE	DRAWING NUMBER	
1	11/11/11		

Figure 3-3-1-D Horse drum cleaner concept

An on-site mobile plant prototype for washing oily sand and pebbles was designed and tested in 1985 by these research groups (Bocard et al. 1986). Composed mainly of a horizontally rotating wash drum with a screen, a hydrocyclone to separate the sand from the wash water phase and a vibrating screen for sand dewatering, this unit was mounted on the bed of a semi-trailer along with two transfer pumps. This project involved laboratory and pilot-scale trials to define the process and washing products and to select the equipment, followed by the construction and trial of a prototype with a throughput of 20 tonnes of oiled sand per hour.

The equipment was tested in terms of the following main functions:

- washing function for the desorption of the pollutant;
- solid/liquid separation functions to transfer the pollutant to the water phase and leave a wet sand with a very low hydrocarbon content;
- liquid/liquid separation function to concentrate the pollutant in fluid form for subsequent treatment and recycling of wash water.

A diagram of the elements making up the CEDRE/IFP prototype is given in Figure 4. Contaminated sand is fed into the hopper by means of a shovel loader then transferred to a drum scrubber by a conveyer belt. Heated wash water (15-20°C to 50-60°C depending on degree of weathering) and cleaning agents are added. The sand/water/cleaning agent mixture is stirred and contacted for approximately 5 to 10 minutes then transferred onto a 5 mm grate to eliminate the bulky products such as gravel, stones and seaweed. The recovered sand is diluted with recycled wash water then pumped to the hydrocyclone. The oil-rich liquid phase leaving the overflow is carried by gravity into the settling tanks. The solid phase (washed sand) leaving in the underflow is transported on a vibrating belt, for maximum elimination of interstitial water, to a storage area. It is then returned to the site from which it was taken.

Two series of tests were carried out: one with 15 day weathered oil on sand (recent pollution) and a second with oil naturally weathered for several months on sand (old pollution). Washing quality was reported excellent in both cases (recent pollution - 90%, old pollution - 80% oil removal). A throughput of 18 metric tons of washed sand was achieved. Three types of cleaning agents were tested containing

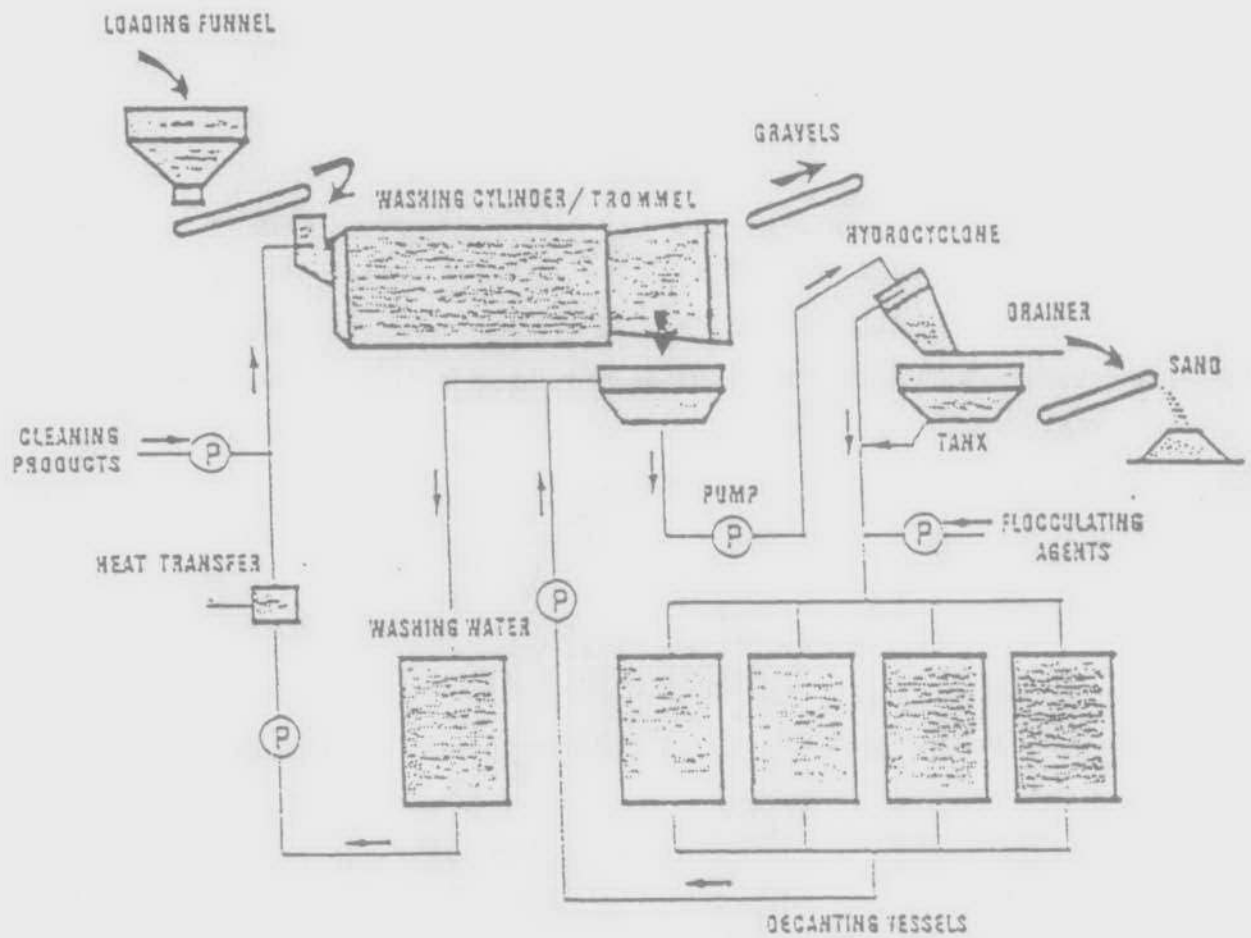

Figure 4: Outline flowsheet of the CEDRE/IFP mobile plant

varying amounts of ionic/non-ionic surfactants in aromatic/non-aromatic petroleum cuts. It was found that in the case of unweathered sand/oil mixture, the addition of a surfactant did not improve washing efficiency. The sand weathered for several months, was more difficult to clean, requiring a washing temperature of 40°C. The unweathered sand was washed at 30°C. A relatively small amount of makeup water was required, of the order of 5 to 6 m³/hr. This system is transportable by highway and is easily assembled by means of flexible couplings.

The mobile plant, designed for washing polluted sands was put to use following the Amazzone spill on January 31, 1988. This incident involved about 1500 tons of a highly paraffinic medium fuel oil along 300 km of the coast of Brittany (Huet et al. 1989). Pebble beaches were polluted, which had been especially difficult to clean during previous spills. An attempt was therefore made to clean the pebbles using the mobile sand-washer plant. The plant prototype was very easily adapted to washing the pebbles. The plant worked smoothly with a load of 20 to 25 m³/hr, using a petroleum solvent as a washing agent. A total of 1400 m³ was cleaned in 10 days. In comparison to other potential oily pebble beach cleaning techniques, the plant prototype proved very effective (good cleaning and high throughput was achieved) and competitive (cheaper than quicklime treatment). This technique also offered the advantage of returning the cleaned pebbles to the beach, thus preserving the pebble bank's anti-erosion function.

Plant prototype modifications for pebble cleaning included:

- installation of a rinsing device at the exit end of the drum scrubber to rinse off the thin film of oil and cleaning products as the pebbles pass through the trommel;
- attachment of three fire hose nozzles to a bank at the output of the trommel

Results from this washing trial suggested that the use of the mobile sand-washing plant prototype for cleaning shingle/pebble beaches was entirely feasible. The prototype effectively cleaned a polluted pebble beach without requiring significant modifications to the existing plant.

There have been no new developments in the area of pebble/cobble washing by the CEDRE, IFP and LCPC (Bocard 1990).

2.2 HOMER GRAVEL WASHER

The "Homer Gravel Washer" was developed privately to wash oil contaminated gravel from the "Exxon Valdez" spill in Prince William Sound. The system consists of a cantilevered trough and oil/water separators and heaters. Oiled gravel is manually loaded into the trough. Hot water is added and the gravel manually agitated for 5 - 7 minutes. Once the agitation is completed, the water/oil is drained out one end of the trough by tipping, then the cleaned gravel is removed at the other end of the trough, again by tipping. The oily water is sent to a separator where the oil is removed and the water recycled and reheated.

Roughly 10 minutes of operational time per batch was required during tests with oiled gravel from Prince William Sound - a batch consisting of a 5 minute wash period plus cycling time for 10 bags of gravel, at an estimated 20 - 30 lbs per bag. During the test period, 60 bags of gravel were processed in 1½ hours. The 60 bags of gravel were estimated to be equivalent to 0.54 yd³, giving a throughput rate of 0.36 yd³/hr or 0.27 m³/hr.

The oil removal effectiveness of this system was not quantitatively determined, however visual observations of the final product indicated very good results. The energy usage is likely to be high due to the large quantities of hot water used. Heli-portability is likely feasible in units. The weight of the gravel washer is unknown but assumed to be quite high due to the number of steel tanks.

2.3 NORTHWEST PROCESSING INC. BEACH CLEANING SYSTEMS

The Northwest Processing Inc. is a hazardous waste recycling facility which converts dangerous waste product into resalable products. Some of the materials that the plant is designed to process include: mineral spirits/oil, gasoline/diesel blends, gasoline/water mixtures, refinery tank bottoms, waste lubricating oils/solids/water, etc. They have also developed cleaning systems applicable to oily beach clean-up capable of:

- removing tar/asphaltic material from large rocks, rock cliffs and shoal areas;
- removing mousse from above and below the water level;
- removing, treating and returning the cleaned saturated sand and gravel mixtures to the beaches.

The systems have optimum throughput rates of 40 to 800 yd³/hr. Assuming a 50% reduction in efficiency and converting the cubic yard measurement to surface measurements 3" in depth, a small system would yield approximately 240 yd²/hr. The largest system would cover roughly 4,800 yd²/hr of oiled beach. These systems can be deployed from barges, skids, excavators or hoes. Heli-portability of such systems is unlikely (Marshbank 1990). A flowsheet and drawing of a Northwest Processing system is shown in Figures 5 and 6.

2.4 OILY WASTE WASH PLANT - A.J. ENERGY INC.

An "Oily Waste Wash Plant" was proposed to the Alaskan government by A.J. Energy Inc. for consideration and possible application to the Exxon Valdez spill. A bench scale prototype of the plant was set-up but mechanical difficulties with one of the pumps prevented any actual testing. Lack of funding has halted further development of this idea and a full scale plant has, to date, not been built (Jorgensen 1990). (The U.S. Department of Energy was to provide the funding initially, however a study revealed the concept to be uneconomical.)

The plant (see Figure 7) is designed to handle a range of sediment sizes, from sand to cobble and large rocks. A basket arrangement with interchangeable screens of variable mesh size would permit the selective washing of debris and sediment. The system would make use of readily available materials (i.e., 35 yd³ dumpsters). The system would be portable and come complete with its own generator and pumping unit.

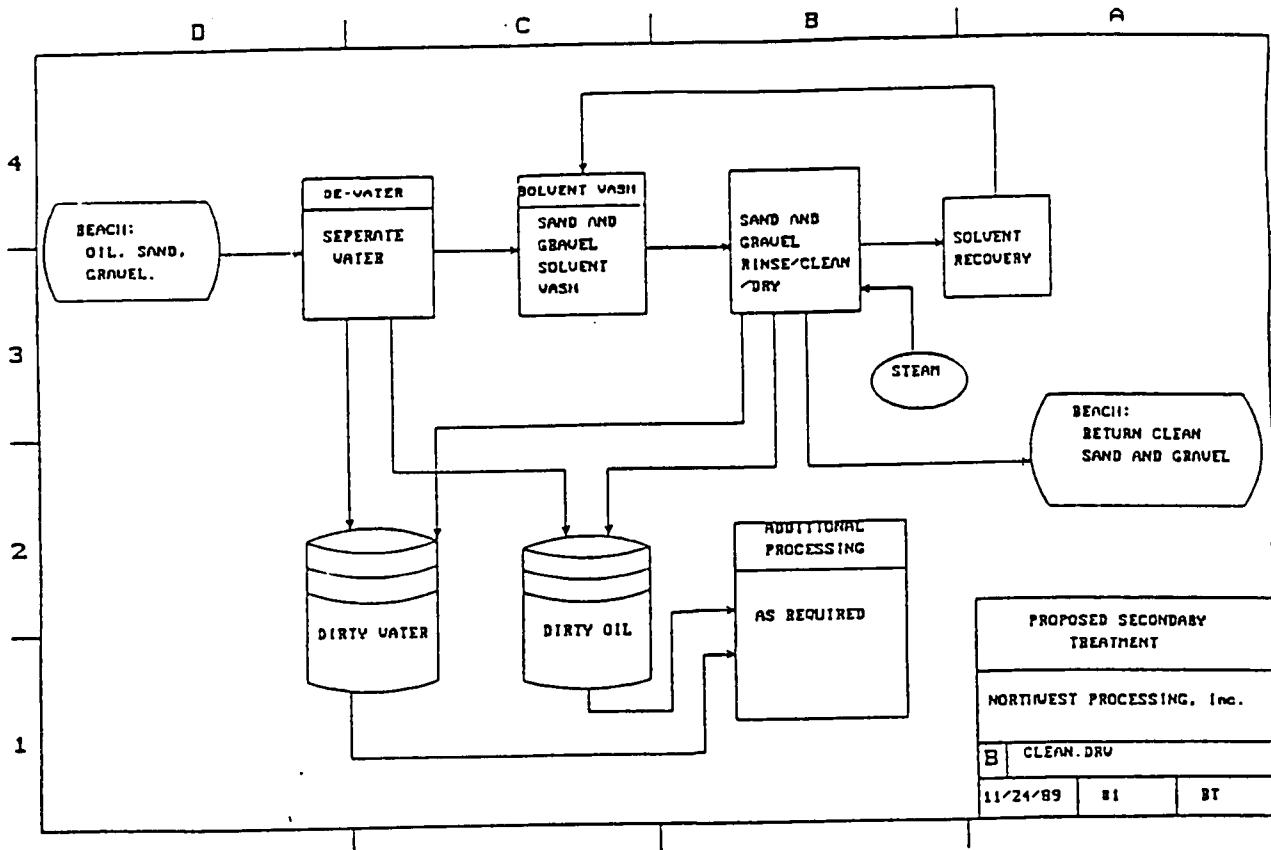

Figure 5: Proposed secondary treatment flowsheet for Northwest Processing System

PROCESSING BARGE

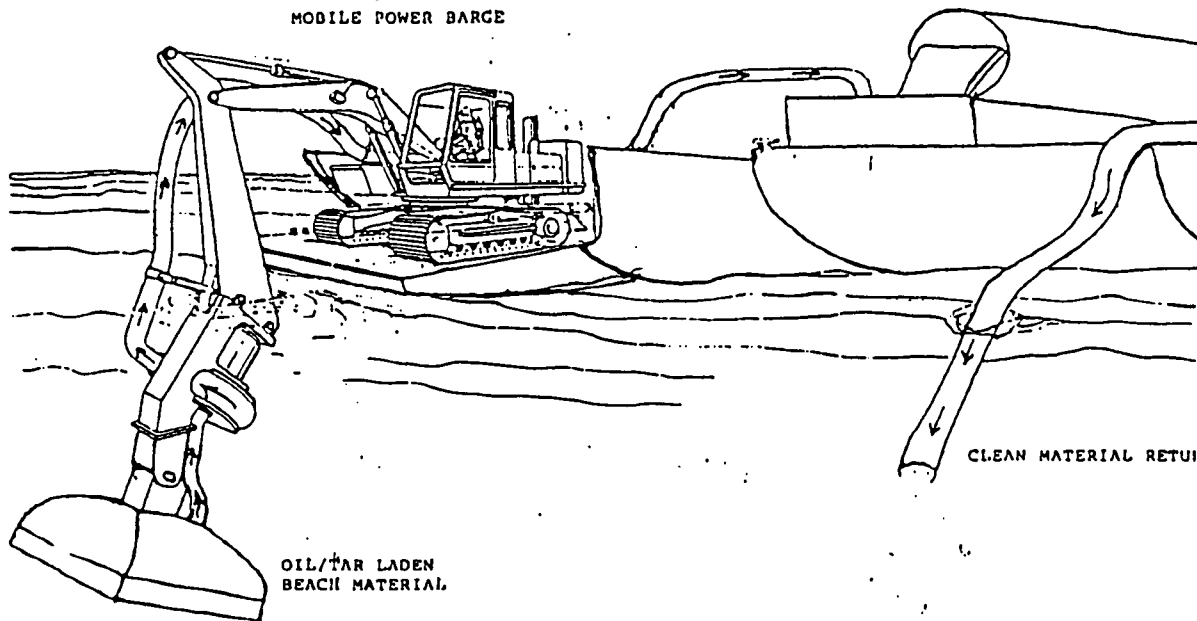

Figure 6: Northwest Processing beach cleaning system

Piping Diagram, Oily Waste Wash Plant, A.J. Energy, Inc.

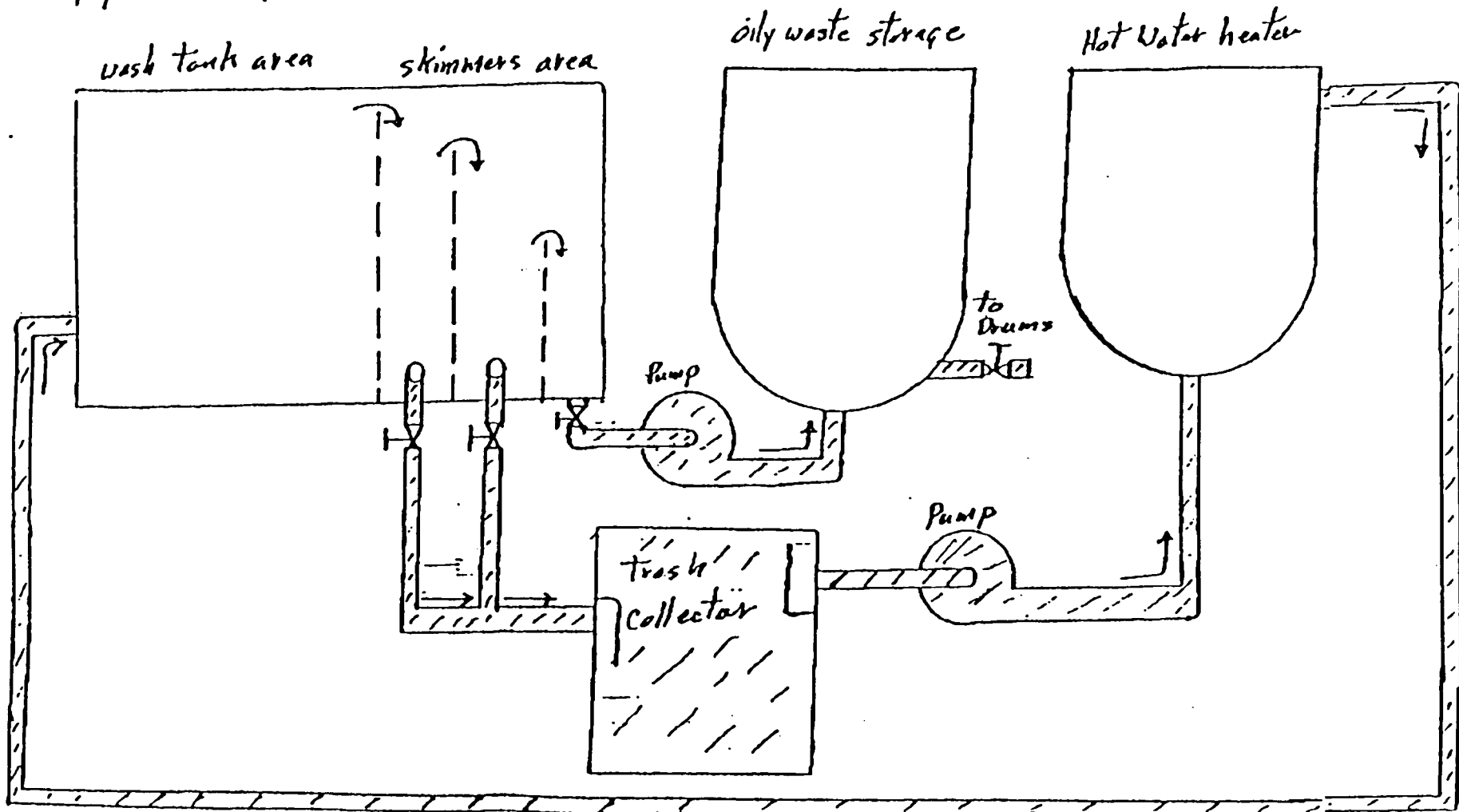

Figure 7: A.J. Energy oily waste wash plant

2.5 SUMMARY

Table 1 is a summary of the applicability of existing beach cleaning equipment surveyed during this study and as well as those investigated in the 1984 COOSRA study. Most research in the area of oily beach cleanup has dealt with the modification of existing beach cleanup equipment, normally used to pick up litter, debris or seaweed. Existing systems for washing recovered oily sand/pebbles/gravel are based mainly on the principle of immersion, whereby the soiled material is immersed in a water/cleaning agent solution, and mixed in a washing cylinder or drum. The oil is then floated to the top and removed while the cleaned material is removed from the bottom of the vessel and further processed. A database for cobble washers and related technology, submitted to the Oil Spill Response Centre, Anchorage, Alaska following the spill in Prince William Sound can be found in Appendix A.

TABLE 1
Applicability of Existing Beach Cleaners †

Machine	Sand	Applicability to Target Shoreline Pebble or Gravel	Cobble	Air Deployment Capability	Propulsion System Requirement	General Remarks
Oily Beach Cleaner	Yes surface clean only	Possibly small size coarse sizes unknown	No	Possibly wt unknown	Large FEL	Roller 8' wide; Bagger system powered by front-end loader (fel) hydraulics
Beach Maintenance Cleaner	Yes surface clean only	Possibly small size coarse sizes unknown	No	Yes	Pulled behind a small truck or tractor	Truck to straddle the line of pollution. Vehicles will mix sediment and oil on wide polluted areas.
Beemer Beach Cleaner	Yes (to 10 cm depths)	No	No	Possibly wt unknown	25 HP tractor (min) recommended	A few 25 HP tractors weighing under 900 kg are available.
Comar - Mobile Surface Cleaner	Yes surface only	Possibly small size surface only	Mfr. claims useable on surface only	Yes in three components	Small 4 WD tractor	Recovery performance on coarse & porous beach sediments is questionable since slurries created in front of the surface cleaner would likely penetrate the surface. Operation on rough terrain is also questionable because of the small dia. solid mount wheels and low ground clearance of the surface cleaner.
Vikovac & Norvac	Yes surface only	Yes surface only	Yes surface only	Yes	N/A	Mobility may be limited on stretches of coarse sediment beach. The Norvac Power Pack could be fitted with larger dia. wheels, easy and timely movement to various locations may be limited because of the component nature of the systems and associated hoses.
Selective Drum (Cedre)	Yes surface only	Possibly small sizes	No	Possibly in sections, wt unknown	Tractor 40 HP min. heli-portability	40 HP tractors are over the limit for heli-portability
Rolba Uma 150 (Cedre Modified)	Yes to depth of 10 cm	No	No	Wt unknown	Tractor Powered HP unknown	May require considerable tractive effort from the tractor because of the soil cutting function. The tractor also powers the mechanical systems so the HP may be over the limit for heli-portability.
Modified Denver Rake Classifier	Yes	Yes	?	No	N/A	Very Complex
Modified Hardy Dadmore Submerged Screw Washer	Yes	Yes	?	No	N/A	Very complex.
Mobile System for Cleaning Oil Contaminated Beach		No	No	No		
Froth-Flotation Beach Cleaner	Yes	No	No	No		
Mobile Plant Prototype (CEDRE)	Yes	Yes with modification	?	Possibly in sections, wt unknown		
Homer Gravel Washer	Yes	Yes	Yes	Likely, in units		
Northwest Processing Mobile System	Yes	Yes	Yes	No	Mobile Power Barge	

† S.L. Ross, 1985

3.0 PROTOTYPE DESIGN

3.1 DESIGN CRITERIA

A thorough investigation of state-of-the-art beach cleaning equipment revealed that a mechanical cleaning system was required for use on the following target shorelines:

- inaccessible mixed sediment beaches;
- cobble beaches; and
- boulder beaches.

In view of the above applications, the following criteria were set for the prototype design:

Feed Material Size:	Small sediment (slightly larger than sand grains) to 25-30 cm cobble.
Simplicity:	Materials of construction should be readily available; the unit can be easily assembled on-site.
Mechanical reliability:	Drive and support systems to be of common manufacture.
Heli-portability:	The system is composed of easily assembled components weighing under 900 kg (for Bell Jet-ranger transport); components have external dimensions of less than 200 cm wide x 270 cm high (for C 130 Hercules transport).
Throughput:	20 tonnes/hr, equivalent to approximately 100 man hours of manual sediment removal.
Manual Loading:	The system is to be manually loaded with shovels, buckets, etc.
Power Requirements:	Small diesel or AC electric motors.
Washwater/Solvent Requirements:	Variable pressure/flowrate/temperature capability.
Recycling/Oil Separation:	Washwater can be recycled or transferred elsewhere as required. Oil separated with an API-type separator.

3.2 BENCH-SCALE TEST

Prior to designing and building the full-scale prototype, the prototype bench-scale rock washer (S.L. Ross 1984) was refurbished in order to qualitatively determine its ability to remove Bunker "C" oil from cobbles. Tests with gravel and a range of oil types (other than bunker C) had already been performed for the COOSRA study in 1984.

3.2.1 Methodology and Test Matrix

The bench-scale rock washer was configured as follows:

drum porosity:	low (as per S.L. Ross 1984)
rotational speed:	3 rpm
spray nozzle:	Spraying Systems "V-jet" 4005
Water pressure/flow:	400 psi = 0.09 L/s 750 psi = 0.11 L/s
Water temperature:	10°C and 40°C
Spray angle:	30° left (as per S.L. Ross 1984)

The cobbles purchased for the tests averaged from 200-250 mm in size and weighed approximately 10 kg each. For these tests 7 cobbles, with a total weight of 75 kg were loaded into the washer and then coated with 0.75 kg of Bunker "C", for an initial oil loading of 1% by weight. The drum was then rotated for 30 seconds to 1 minute until the cobbles were thoroughly covered with oil. At this point the spray was turned on and the test begun.

Post-cleaning samples of the cobbles were not taken because the Bunker "C" removed from the cobbles coated the inside surface of the drum and once the drum was stopped, dripped back onto the rocks. Cleaning efficiency was visually estimated.

The following test matrix was completed:

3 wash times (1, 3 and 5 minutes) x 2 water pressures (400 and 750 psi)
x 2 water temperatures (10°C and 43°C).

3.2.2 Observations

In general, the size of rock tested was the maximum for the device: Two cobbles tended to stack themselves against the side of the rotating drum and were carried high up the side before falling; the impact loads on the drum were high; and three times individual rocks fell out of the prototype.

The washing process for cobbles is one of the spray flushing oil off the rocks, rather than a self-abrading action as noted in previous tests with gravel; as such slower rotational speeds and higher pressure sprays (400 psi) were most effective.

At a spray pressure of 750 psi with 10°C water the rocks were not clean after 1 minute, were noticeably cleaner after a 3 minute wash and most of the oil (except a few coin-sized patches) had been removed after a 5 minute wash time. Similar results were obtained with a 400 psi spray.

With 43°C hot water significant improvements in cleaning were apparent: after a 3 minute wash time the rocks were as clean as they had been after a 5 minute wash with cold water; after a 5 minute wash time with hot water the rocks were virtually spotless.

It was apparent that for the removal of Bunker "C" it would be necessary to use a much larger hole size and greater porosity for the perforated metal than was tested with the bench scale prototype (about 1 mm holes spaced 5 mm apart). The Bunker "C" removed from the cobbles had difficulty passing through the walls of the drum of the prototype.

3.3 PROTOTYPE DESIGN

The prototype design (Figure 8) was based on simplifying the COOSRA design by deleting movability criteria and feed and output material moving systems. The basic components of the proposed system were a 3 m long x 0.9 m diameter drum with internal auger flights and two perforated metal/screening sections for water/oil/fines removal. The general arrangement and piping schematic for the rock washer as tested is shown in Figure 8. Blueprints and equipment specifications can be found in Appendix C.

The drum was constructed of standard (1.6 mm thick) corrugated culvert. Internal auger flights (11 ga. steel) were placed at 45 cm intervals along the length of the drum to increase the sediment residence time. Angle iron (1"x1"x1/8") was tack welded between auger flights for reinforcement and to increase tumbling. One cm holes were drilled every 10 cm over five corrugations in two sections of the drum to allow for water/oil/fines removal.

Five Vee-jet nozzles, mounted along the length of a 3/8" SCH80 pipe inside the drum, were used to spray water onto the sediment. Wash water was pumped with a Hypro piston pump, capable of delivering 7.35 gpm @ 400 psi. Recycled wash water passed through a visual liquid strainer to remove fines before entering the pump.

The drive mechanism for the prototype consisted of a 4.0-7.5 hp Lister Petter diesel engine and a series of gear reducers, chains and pulleys. A 10:1 reduction from the engine, which operates at 1500-3000 rpm, was achieved using a chain drive. From this point a double vee belt pulley powered both the water pump and the mill belt pulley used to rotate the drum. The mill belt was placed around the outside perimeter of the entrance to the drum.

The support structure for the rock washer was built from 3" standard C-shaped channel. The frame consisted of two identical welded sections, bolt connected at two points on the base between the two triangular sections (shown in Figure 8). This enabled the frame to be disassembled into components having dimensions which met the heli-portability criteria.

The drum rotated on and was supported by eight neoprene casters (6" dia.) each with a capacity of 500 lbs (227 kg). Angle iron bent around the outside perimeter of the drum, formed a track in which the casters could ride.

The design rotational speed of the drum was 6 rpm, which, with an auger pitch of 45 cm, gave a residence time of roughly 60 seconds. Wash water (cold) could be sprayed at 35 kPa from 5 internally mounted spray nozzles at a total flowrate of 30 L/min (1.8 m³/hr). For the prototype, provision were made for hot-water spray and for the first nozzle to spray diesel fuel (for softening/loosening of baked-on oil).

The design throughput of the device was 20 tonnes/hr (10 m³/hr) with a holdup of 500 kg of sediment.

The washwater/oil/fines mixture exits the drum at two perforated sections in the drum and collects in a simple separator tray placed beneath the device. The fines settle in the first section of the tray while oil and water move to the centre to separate; oil is skimmed off and the water recycled. Wiper blades could be included against the outside of the drum to assist in removing viscous oils from the drum surface if required.

On-site modifications included the following:

- a plywood trough lined with plastic was built and placed at the entrance of the rock washer in order to facilitate manual loading;
- angled eaves troughing was used to collect water leaving the output end of the rock washer and return it to the separator.

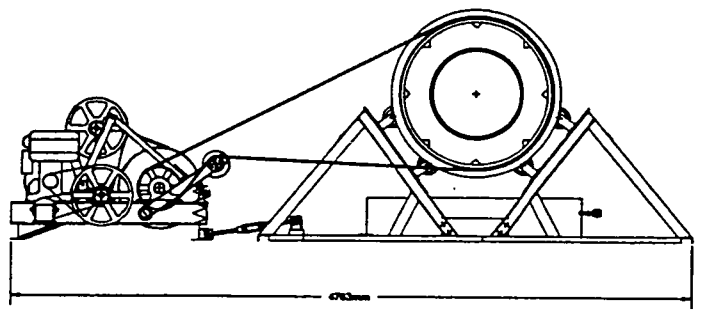
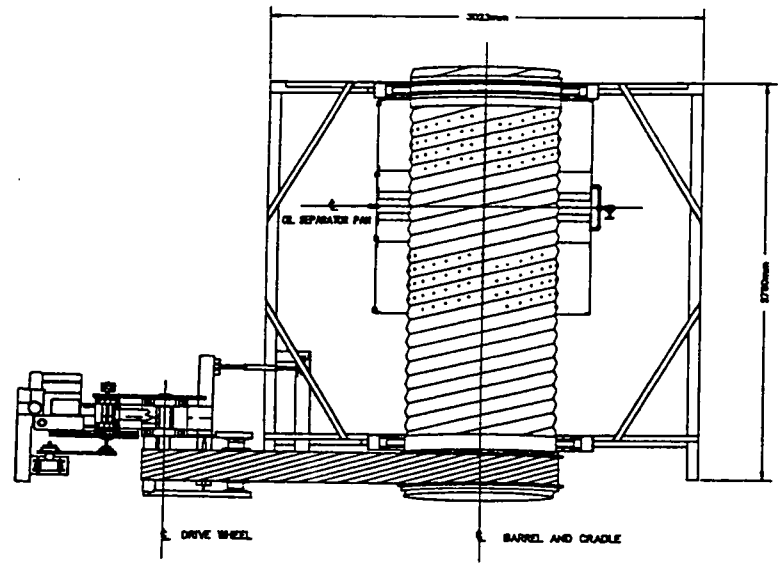

PLAN

ELEVATION

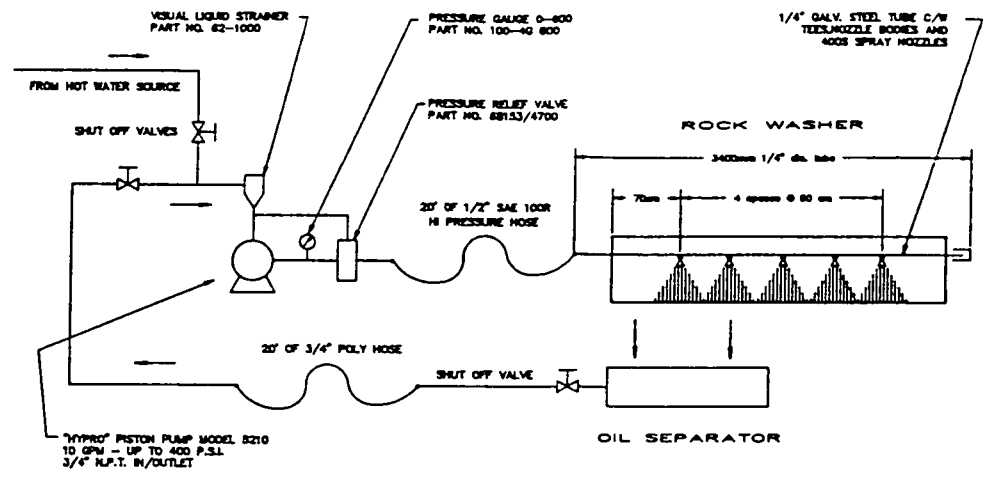

SPRAY HEADER PIPING SCHEMATIC

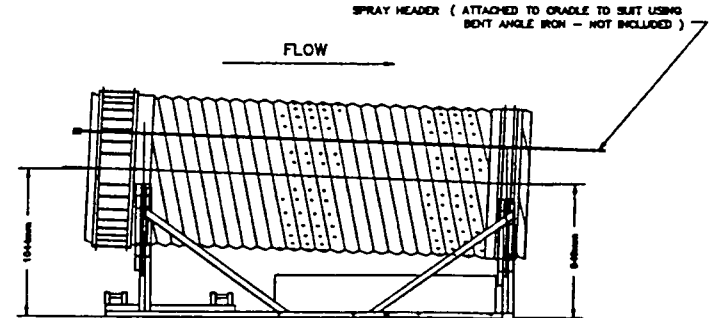

PROFILE

DRIVE AND DRIVE BELT NOT SHOWN

	S. L. Ross Environmental Research Limited	
	ROCK WASHER GENERAL ARRANGEMENT AND PIPING SCHEMATIC	
DATE: 01/19/90 DRAWN BY: [blank] CHECKED BY: [blank]	SHEET-5 - D 0	

Figure 8: Rockwasher - general arrangement and piping schematic

4.0 TEST SITE, MATERIALS AND EQUIPMENT

4.1 TEST SITE AND SITE LAYOUT

The trials were conducted near Woodlawn, Ontario. The test site (Figure 9) had the following facilities:

- water @ 30 L/min minimum (6.6 gal/min) with consumption to a maximum of 2700 L/day
- water @ 40°C from a domestic hot water tank
- accessible by truck
- plastic lined sand/gravel pad 4 m x 2 m x 20 cm (1.6 m³) or level ground

4.2 TEST MATERIALS

The following materials were used in the testing of the rock washer.

4.2.1 Test Oils

Two test oils were used, an Ontario light crude oil and Bunker "A". Crude oil was used in three different states: fresh, weathered and emulsified. Crude oil termed "fresh crude" in the test matrix, was lightly weathered by air sparging, to at least 10% evaporative loss. The weathered oil was prepared by spraying fresh crude on the test sediment and allowing it to weather naturally, outdoors for a period of at least two weeks. The "emulsified" oil was created by mixing 25% crude oil and 75% water in a drum using a paint mixer. As the emulsion obtained was unstable, some Bunker "A" (roughly 10%) was mixed with the crude. This resulted in stabilizing the emulsion.

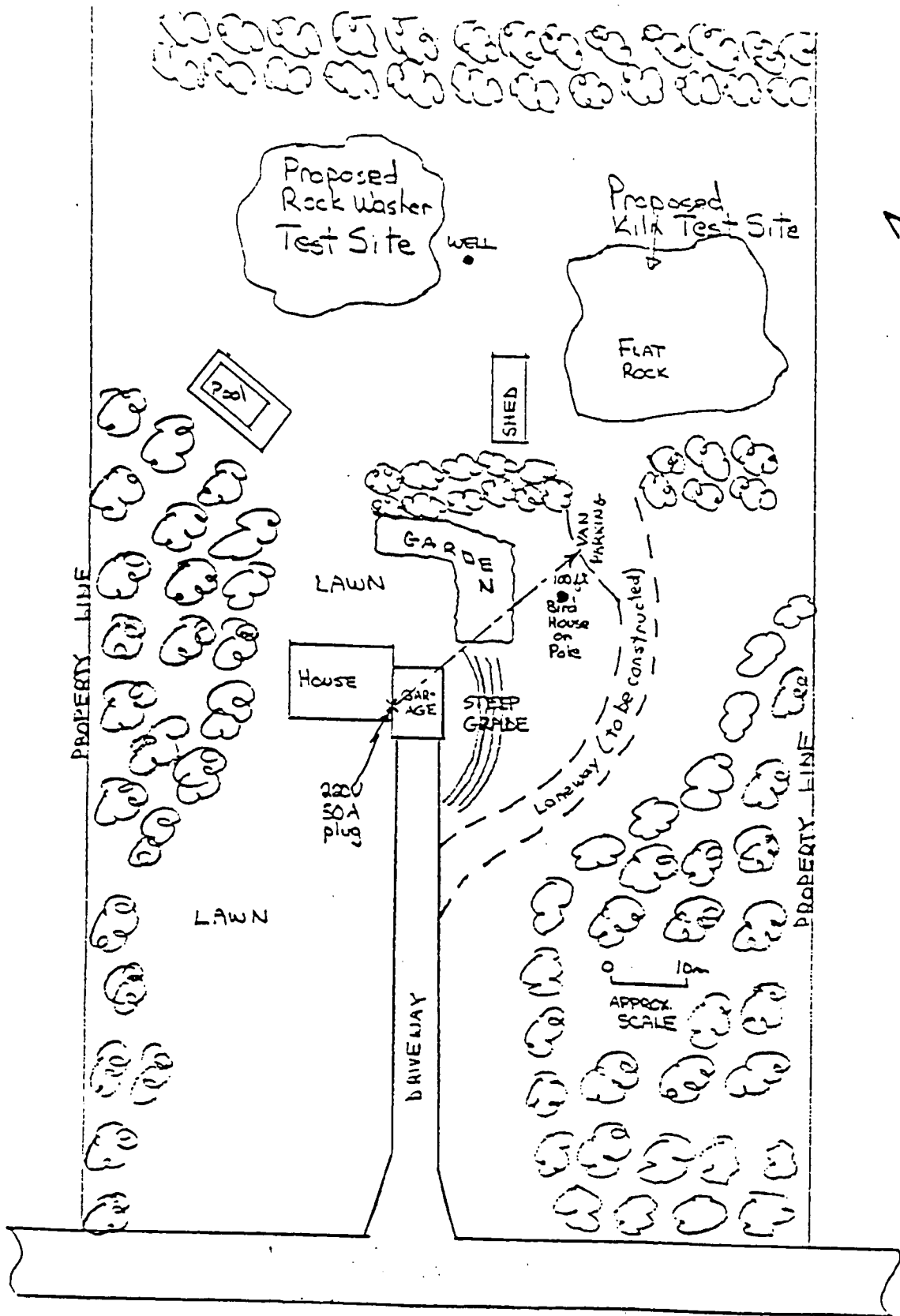

Figure 9: Test site sketch

The following table lists the initial properties of the oils used in this study.

TABLE 2
Initial Properties of Test Oils

Test Oil	Viscosity (m.Pas) @ 23.4°C	Density (kg/m ³) @ 21.8°C
"fresh" crude	10	834
emulsified crude #1	41	895
emulsified crude #2	--	967
Bunker A	96	920

4.2.2 Test Sediment

The rock washer was tested with three types of sediment: a coarse gravel ranging in size from 50 to 100 mm in diameter (denoted as 50 mm), large cobble ranging in size from 150 to 200 mm in diameter (denoted as 200 mm) and a mixture consisting of cobble, gravel and sand in a 45:45:10 ratio by weight. Sand was added to the mixed sediment to test the rock washer's effectiveness in removing fines from the coarser sediment. The test sediment was obtained from a local quarry which provided the above size ranges.

Oil loadings in the 0.25 to 2% by weight range were used (0.5 to 4% by volume). Smaller oil loadings were applied to the larger sediment because of its reduced surface area to volume ratio.

The sediment was prepared for testing as follows:

- runs with Bunker A, fresh and emulsified crude: the sediment was prepared by mixing known weights of sediment and oil in a 6 ft³ portable cement mixer until all the sediment was thoroughly coated with oil;
- runs with weathered crude: three weeks prior to the tests, six plots were prepared for weathering oiled sediment. Each plot consisted of a 2 m² enclosure constructed of 2" x 6" lumber (on side) lined with 6 mil plastic sheet. In two of these, 1 m³ of coarse gravel was placed; in another two, 0.5 m³ of large cobbles was placed and in the last two, a 45:45:10 wt. mixture of cobble, gravel

and sand was placed. Appropriate amounts of "fresh" crude oil were sprayed onto each plot using a "backpack" sprayer.

4.3 TEST MATRIX

The following was the proposed test matrix for the program.

Rock Size Size (mm)	Oil Type	Oil Loading (wt %)
50	"fresh" crude	2
		0.5
	weathered crude	2
		0.5
	emulsified crude	2
		0.5
200	Bunker "A"	1
		0.5
	"fresh" crude	1
		0.25
	weathered crude	1
		0.25
mixture (45 wt% each of 50 and 200 and 10 wt% of 0.5 mm coarse sand)	emulsified crude	1
		0.5
	Bunker "A"	0.5
		0.5
	"fresh" crude	1
		0.25
	weathered crude	2
		0.25
	emulsified crude	1
		1
Bunker "A"	2	
	0.25	

A total of 24 tests were planned for the program.

5.0 TEST PROCEDURES

5.1 TEST METHODOLOGY

Figure 10 shows a preliminary test site layout. Photographs of the set-up are shown in Figure 11. The following were the procedures used for each test.

1. The sediment/oil combination was prepared (using either the 6 ft³ portable concrete mixer for the Bunker A, and emulsified crude runs or spraying/coating the oil for the weathered crude runs) and placed in the lined trough at the feed end of the rock washer.
2. The rock washer was started and sprays turned on.
3. The stone was shovelled or manually pushed into the feed end of the washer at a steady rate. Over the first minute, or longer if necessary, of the test the washer speed and sprays were adjusted to give optimum cleaning; the remainder of the test was run at the selected conditions. If the oil type warranted it (i.e., Bunker "A") hot water was used for the spray.
4. On completion of the test, the processed stone was prepared for the next test.

5.2 SAMPLING AND ANALYSIS

For each test, samples were taken to monitor the following parameters:

Prior to Test

- 1) viscosity and density of oil
- 2) concentration of oil in feed determined by weighing total oil applied to a known weight of sediment

During Steady-State Operation

- 3) oil content in recycled washwater
- 4) concentration of oil in output (1 sample per run)
- 5) emulsion water content in recovered oil.

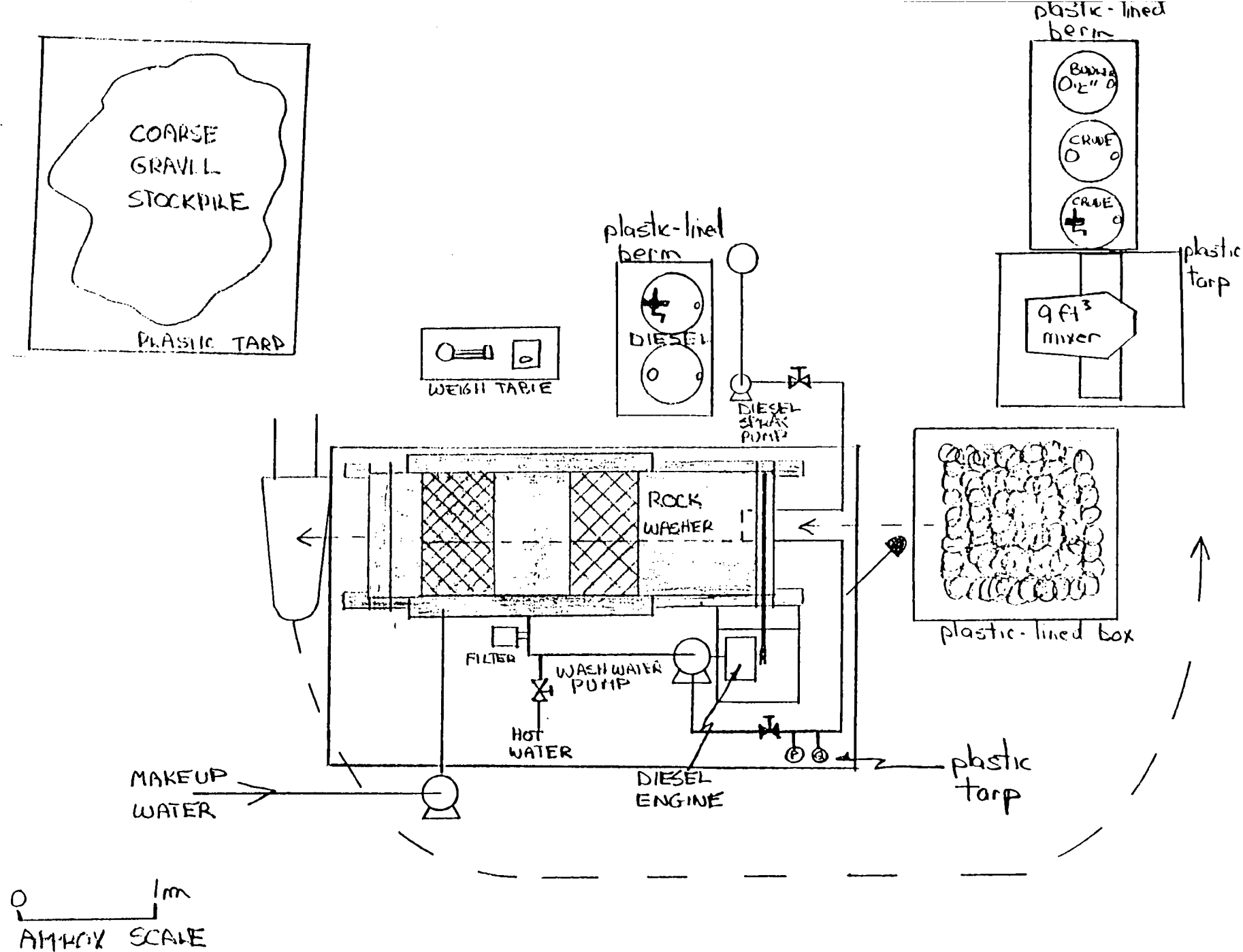

Figure 10: Test site layout



Figure 11: Rockwasher test site

The laboratory analysis of the collected samples was performed by EED at the River Road laboratories using the following methods:

1) Viscosity:

- measurements performed on Bohlin Visco 88 rotational viscometer

2) Density:

- determined using an Anton - Pear DMA45 digital density meter as per ASTM D4052-86

3) Concentration of oil in output:

- three methods were used in this determination.
 - i) Processed sediment samples were weighed, then washed for approximately five minutes in a tared 3000 ml beaker with dichloromethane as the solvent. The cleaned rocks were removed from the wash bath and allowed to dry. The sampling bag was then washed in the solvent bath to remove any remaining oil. The cleaned samples were reweighed and the weight of oil on the sediment determined.
 - ii) Oil remaining on the sediment was also determined by measuring the amount of oil removed from the sediment during the solvent wash in method i). The solvent in the tared beaker was allowed to evaporate and the beaker containing the remaining oil was reweighed and the oil mass determined. This method was used to compensate for any silty material removed during the solvent wash. Weights obtained from both methods were averaged and compared against the sample weight to gain a weight percentage of oil present on the processed sediment.
 - iii) The sediment and sampling bag were weighed and washed with about 250 ml of dichloromethane. The rinsing was collected and filtered using #1 Whatman paper. The filtered rinsing was evaporated to exactly 10 ml, initially with a rotovap, then finished off under a stream of N₂. The amount of oil (μg) in the 10 ml was determined using a U.V. spectrometer and calibration curves of known concentrations of oil in water.

4) Emulsion water content in recovered oil:

- determined using a Metrohm 701 Karl Fisher automated titrator as per ASTM D4377-88.

5) Oil content in recycled washwater

- measurements performed on Horiba OCMA-220 Oil Content Analyzer

5.3 DATA COLLECTION

For each test, during steady-state operations, the following was also measured:

- washer rotational speed (timed with stopwatch)
- washwater and/or diesel spray flowrates and pressures (timed flow and pressure gauge)
- sediment throughput rate
- sediment residence time

6.0 RESULTS AND DISCUSSION

The full-scale prototype rock washer, tested with gravel, cobble and mixed sediment showed promising results. These are given in Table 3. The following parameters were monitored throughout the trials: oil in output, emulsion water in recovered oil, oil in recycled water, throughput rate and residence time. Oil in output, throughput rate and residence time have been plotted as a function of oil type and loading for each rock size tested (see Figures 12a-c). Visual and photographic observations of the test sediment were also made, at the beginning and at the end of each run. Table 4 outlines the visual observations for each run performed and the photographs are found in Figures 13 to 16.

Some changes to the original test program were made once on-site testing began. It was found that an oil loading of 2% exceeded the amount required to completely saturate the test sediment, and resulted in oil collecting in the bottom of the loading trough. An oil loading of 1% was therefore used, except in the case of the weathered oil. This oil was applied 2-3 weeks prior to testing, in two batches on separate days in order to allow the oil to dry onto the sediment. Most of the oil applied in this manner remained on the sediment, even at the higher oil loading. Several of the runs originally planned for testing were omitted. Some of the 0.25% oil loading runs were omitted if the same sediment with a high oil loading was successfully cleaned after one pass through the rock washer. It was assumed that if heavily oiled sediment could be successfully cleaned, lightly oiled sediment would be as well. A total of 19 runs were completed, as well as three reruns for sediment which was not satisfactorily cleaned the first time through the rock washer.

6.1 OUTPUT OIL

The rock washer performance was evaluated quantitatively by determining the amount of oil remaining on the processed sediment and qualitatively by making visual observations of the test sediment before and after each run.

TABLE 3
Summary of rock washer test results

Rock Size (mm)	Oil Type	Oil Loading (%)	Oil in Output (%)	Emulsion Water (%)	Oil in Recycle H ₂ O (ppm)	Water Temperature (°C)	Throughput Rate (kg/sec)	Residence Time (sec)	Visual Observation of Output Cleanliness†
50	fresh crude	1	0.09	27	256	12			1
50	fresh crude	0.5	0.00*	73.61	216	12	3.4	72	0
50	weathered crude	2	0.42	10.0		43	4.5	76	0
50	weathered crude	0.5	0.25			12	3.9	62	0
50	emulsified crude	2	0.01*		388	12	3.7	69	1
50	Bunker A	1	0.02*	70.67		43	3.5	77	3
	2nd wash		0.00*			20	3.4	68	1
50	Bunker A	0.5	0.02*			43	3.5	75	3
	2nd wash		0.00*			20	3.4	68	1
200	fresh crude	1	0.16	79.25	48	12	3.7	60	1
200	weathered crude	1	0.36	0	57	43-12	4.2	75	0
200	weathered crude	0.25	0.52		57	12	4.4	74	0
200	emulsified crude	1	0.57		26	12	3.9	80	2
	2nd wash		0.15			43	4.4	73	0
200	emulsified crude	0.5	0.24			43	4.8	84	0
200	Bunker A	0.5	0.43			43	3.6	72	2
	2nd wash		0.90			43	3.6	66	1
mixture	fresh crude	1	0.35		107	12	3.0	74	1
mixture	fresh crude	0.25	0.26		107	12	3.8	67	0
mixture	weathered crude	2	0.67			12	3.7	70	0
mixture	weathered crude	0.25	0.70			12			0
mixture	emulsified crude	1	0.08			43	4.0	71	0
mixture	Bunker A	1	0.14	44.95		43	2.7	54	2

†0 - sediment completely clean

1 - sediment essentially clean but with a very light sheen of oil remaining

2 - light sheen and the occasional spot of oil remaining on sediment

3 - large spots of oil remaining on sediment - second washing required

* - analysed using method 3iii)

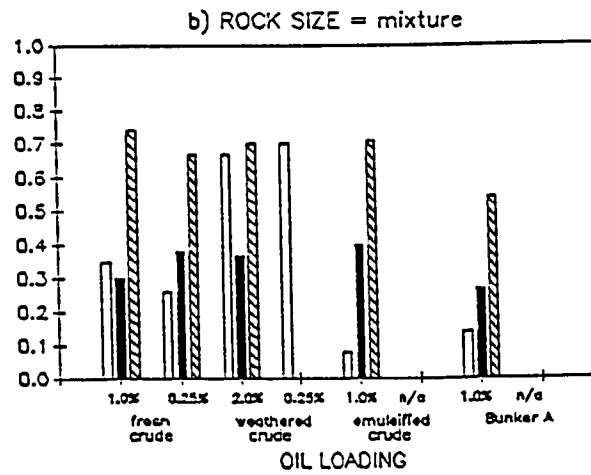
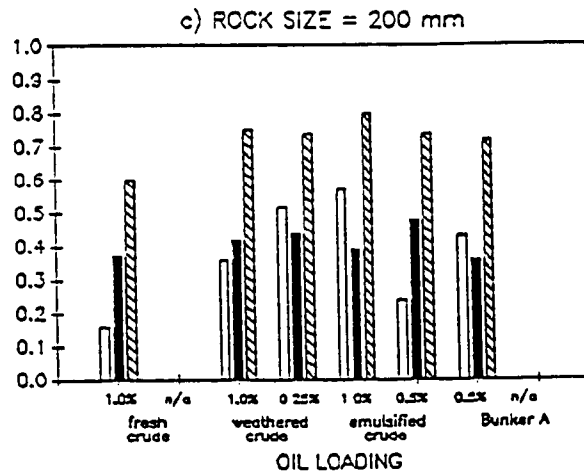
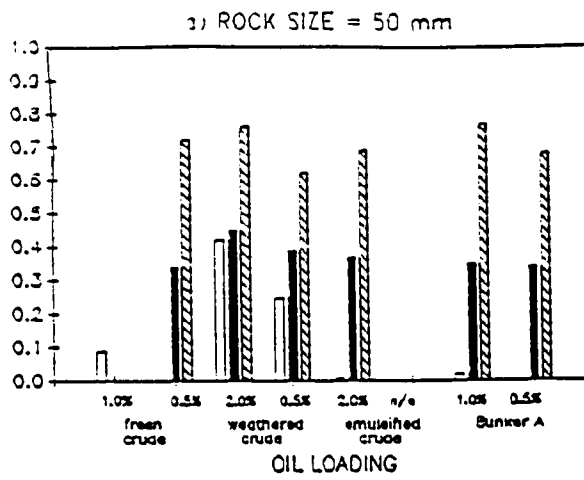

LEGEND:

- oil in output, ppm
- throughput rate, kg/s x 10
- residence time, s x 100

Figure 12: Test results as a function of rock size and oil type



before



after

Figure 13: Fresh crude with gravel

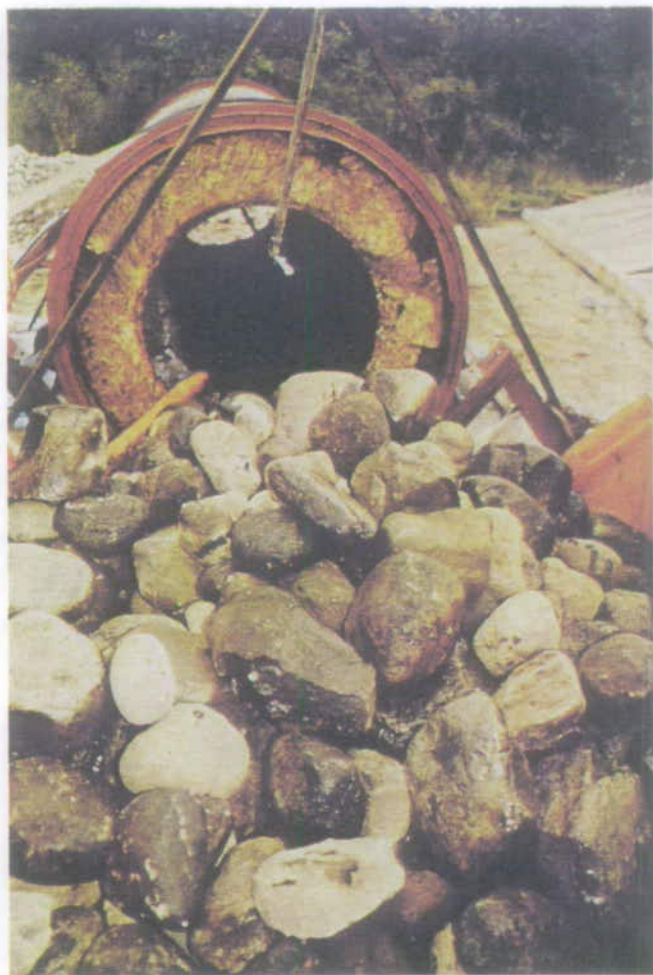

before



after

Figure 14: Weathered crude with cobble



before



after

Figure 15: Emulsified crude with mixed sediment



before

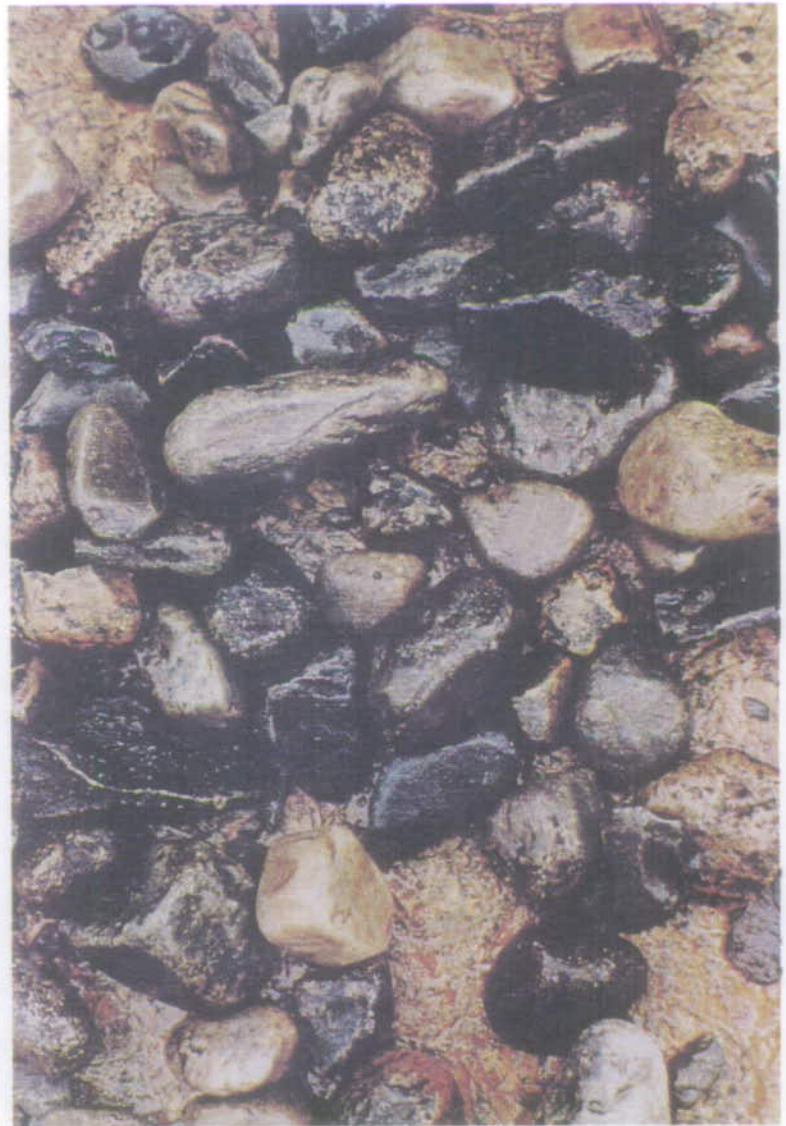

after

Figure 16: Bunker A with mixed sediment

TABLE 4
Summary of Visual Observations of Processed Sediment

Completely Clean	Light Sheen	Light Sheen with Small Spots	Many Large Spots 2nd Wash Required
Fresh crude - 50 mm - 0.5%	Fresh crude - 50 mm - 1%	Emulsified - 200 mm - 1%	Bunker A - 50 mm - 1%*
Fresh crude - mixed - 0.25%	Fresh crude - 200 mm - 1%	Bunker A - 200 mm - 0.5%*	Bunker A - 50 mm - 0.5%*
Weathered - 50 mm - 2%*	Fresh crude - mixed - 1%	Bunker A - mixed - 1%*	
Weathered - 50 mm - 0.5%	Emulsified - 50 mm - 2%		
Weathered - 200 mm - 1%*	Bunker A - 50 mm - 1%†		
Weathered - 200 mm - 0.25%	Bunker A - 50 mm - 0.5%†		
Weathered - mixed - 2%	Bunker A - 200 mm - 0.5%*†		
Weathered - mixed - 0.25%			
Emulsified - 200 mm - 1%*†			
Emulsified - 200 mm - 0.5%*			
Emulsified - mixed - 1%			

* = hot water wash

† = second wash

6.1.1 Quantitative Analysis

The oil content in the output sediment was determined by collecting sediment samples at the end of each run and analysing for remaining oil. Some difficulties were encountered with the laboratory analysis of these samples. Several methods were used (described in Section 5.2) to determine output oil. Two gravimetric methods of analysis were used first which involved removing the oil from the sediment by solvent washing and weighing the samples before and after washing, as well as weighing the removed oil. However, the balance used in these determinations was not reliable, therefore results obtained had a large error (up to $\pm 20\text{g}$). Also, this method did not account for the presence of silt on the sediment, which would have been removed to some unknown degree with the oil during the washing step. Because of the small oil-mass to sediment-mass ratio, even small amounts of silt removed from the sediment would significantly affect the results obtained. Silt removed with the oil would erroneously increase the percentage of oil in the output. These results are therefore not reliable and do not accurately represent the amount of oil remaining on the processed sediment. This is particularly evident in the following runs: i) 200 mm - emulsified crude - 0.25% oil; ii) 200 mm - Bunker A - 0.25% oil; and iii) mixture - weathered crude - 0.25% oil. The percent oil in output for these runs was found to be higher than the initial percent oil loading despite the fact that the visual observations clearly show the rock to be clean after passing through the rock washer.

In general, the numbers obtained for oil in output using the above methods were much higher than expected (0.1 - 0.9 wt %). Unfortunately, most of the samples were analyzed using the above two methods. As these results are not reliable, they will not be further discussed. They have, however, been included in Figures 12a to 12c.

The remaining samples (those marked with an asterisk in Table 3) were analysed for oil using a third method (see Section 5.2). This method involved extracting the oil from the sediment and silt with a known volume of solvent, then determining the percent oil in the solvent by UV spectrometry. Percent oil on the sediment was thus determined independently of any silt removed from the rocks. As expected, these numbers (in the 0.0 - 0.2% range) are much lower than those obtained using the previous methods.

In order to discuss the overall performance of the rock washer as a function of sediment size and oil type, the visual observations will be used.

6.1.2 Qualitative Analysis

A qualitative analysis of the rock washer's performance was carried out, by simple visual observation of the test sediment before and after each run. Photographs of the test beach sediment taken before and after passing through the rock washer are shown in Figures 13 to 16. A scale rating used to describe the degree to which the sediment was cleaned was set up as follows:

- 0 - sediment completely clean
- 1 - sediment essentially clean but with a very light sheen of oil remaining
- 2 - light sheen and the occasional spot of oil remaining on sediment
- 3 - large spots of oil remaining on sediment - second washing required

This scale rating appears in Table 3.

Table 4 is a summary of the visual observations made at the completion of each run. The results indicate that for approximately 50% of the runs, the sediment was completely cleaned, and that for roughly 70% of the runs, the sediment was either completely cleaned or only a light sheen of oil remained after washing. These runs consisted mainly of sediment oiled with fresh or weathered crude. All sediment/weathered crude combinations became completely clean after a single pass through the rock washer. After processing, sediment oiled with fresh crude, at the lower initial oil loadings (0.25-0.5%) was completely cleaned, while a very light sheen of oil remained on the sediment oiled with fresh crude at the higher oil loading of 1%.

These observations indicate that the ease with which the oil types tested are removed from beach sediment is as follows, in order of increasing difficulty: weathered crude, "fresh" crude, emulsified crude and Bunker A. Crude oil, in its various states, was much easier to remove than Bunker A. As expected, Bunker A proved to be the most difficult oil to wash from the beach sediment tested, requiring the use of hot water and/or a second pass through the rock washer.

It is difficult to determine from the visual results if the cleaning efficiency varied with sediment type. Previous tests indicated large cobble was cleaned by the spray flushing oil off the rock, while the washing process for gravel and smaller sediment was enhanced by the self-abrading action of the sediment. Although a great difference in cleaning efficiency was not observed among the sediment types tested, the mixed sediment did seem to be slightly easier to clean than the cobble and gravel.

While the quantitative analysis of oil in the output determined by the gravimetric method was unreliable, the results obtained by UV spectrometry were consistent with the visual observations made of the processed sediment. Oil in the output for gravel and Bunker A (1% and 0.5% loadings) was 0.02%, the highest percentage measured UV spectrometry. Visually, some large oils spots remained on the sediment and a second wash was required (which corresponds to a "3" on the visual rating scale). Processed sediment for runs where the oil in the output was determined to be 0.01% or less by UV spectrometry, were also observed to be either completely cleaned or to be covered with a light sheen of oil (visual rating scale of "0" and "1").

The above comparisons would suggest that, though the visual observations may be somewhat subjective, they do offer a fairly reliable means of evaluating the rock washer's cleaning efficiency.

6.2 SEPARATOR EFFICIENCY

The purpose of the separator tray was to collect the wash water/oil/fines mixture exiting the drum and to separate the components of the mixture in such a way that oil could be skimmed off and water recycled back to the rock washer. Oil content in the recycle water was determined in order to assess the separator efficiency. Separator water was sampled from the spray nozzles as it was recycled back to the rock washer. Samples were taken during several of the fresh, weathered and emulsified crude runs. No samples were taken for the Bunker A runs since fresh hot water was used to wash the sediment and was therefore not recycled. The recycle water data obtained are not accurate measures of the oil concentration in the separator water, but rather of the quality of water recycled and used to spray the oily sediment. The separator was not emptied between runs, therefore oil from previous runs is also likely to be present in the water as well as oil removed during a current run. The data shows that this separator was effective in separating oil from water. Water recycled back to the rock washer contained oil in the 20-400 ppm range. Also, as seen in Figure 17, the separator effectively collected fines and sand washed from the sediment. This observation also indicates that the hole size of 1 cm used in the two perforated sections of the drum was adequate.

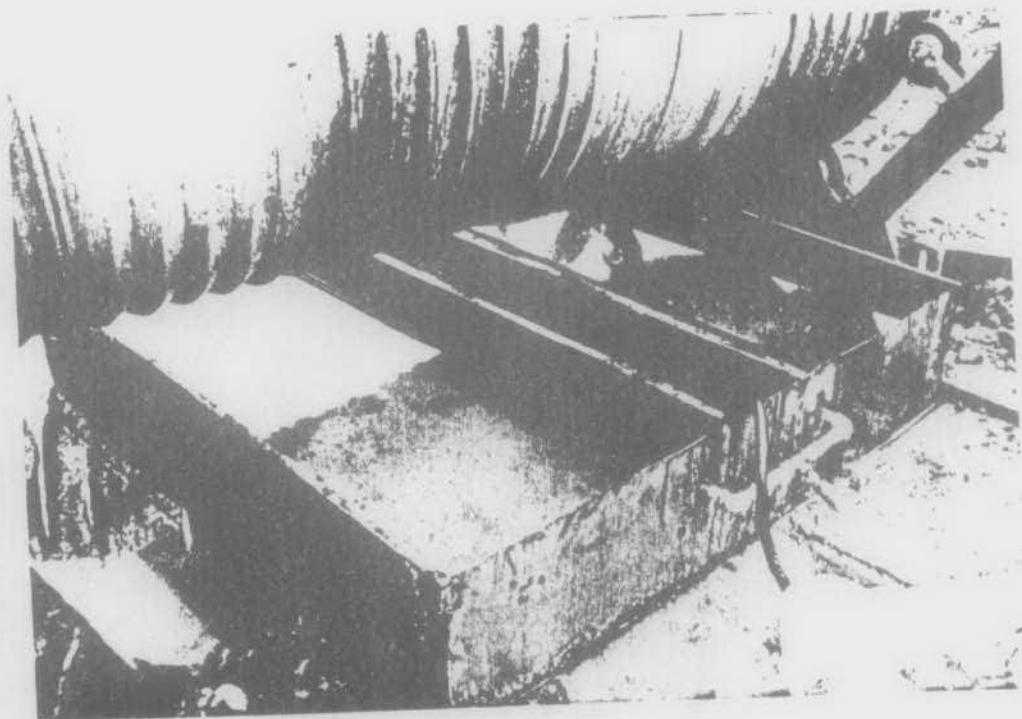

Figure 17: API-type separator

6.3 OPERATING CONDITIONS

It was found that cold water washing with a water pressure of 700 kPa was sufficient for all oil/sediment combinations except those involving Bunker A. Large oil spots remained on the sediment oiled with Bunker A when washed with cold water, after one pass through the rock washer. The rocks were much cleaner after a second pass.

The drum rotation speed was maintained at approximately 5-6 rpm during all runs. It had been planned to vary the rpm, however it was not possible to vary the diesel engine speed in such a way that a change in drum rotation was noticed. A drum rotation speed of 5-6 rpm gave a theoretical residence time of 60-80 seconds, which in fact was the range obtained during the trials (see Table 3). This was sufficient for most runs, with the exception of those involving Bunker A. Longer residence times (lower rpm) combined with higher wash water pressures may have improved the cleaning efficiency in the case of Bunker A contaminated sediment.

The rock washer was manually loaded by two or three people using shovels and rakes. Two people were also required at the output to shovel cleaned sediment away from the end of the drum. Throughput rates varied from 2.7 to 4.8 kg/sec (10 - 17 tonnes/hr). The average throughput rates for cobble, gravel and mixed sediment were 4.0 kg/sec (14.4 tonnes/hr), 3.7 kg/sec (13.3 tonnes/hr) and 3.4 kg/sec (12.2 tonnes/hr) respectively.

7.0 CONCLUSIONS AND RECOMMENDATIONS

7.1 CONCLUSIONS

This rock washer trial was successful in that the prototype tested effectively cleaned oily beach sediment. The following conclusions have been made.

1. Average throughput rates of 4.0 kg/sec (14.4 tonnes/hr) for cobble, 3.7 kg/sec (13.3 tonnes/hr) for gravel and 3.4 kg/sec (12.2 tonnes/hr) for mixed sediment were achieved.
2. The ease with which the oil types tested could be removed from beach sediment was, in order of increasing difficulty: weathered crude, "fresh" crude, emulsified crude and Bunker A.
3. Cold water spray at a pressure of 700 kPa was sufficient to wash all oil types, with the exception of Bunker A, from the test beach sediment. Hot water was required for the Bunker A, as well as a second wash in most cases.
4. The hole size of 1 cm in the two perforated sections of the drum was adequate for the removal of washwater/oil/fines mixture. Wiper blades against the outside of the drum (not included in this prototype) to assist in removing viscous oils from the drum surface, may have been useful, but were not required for the oil/sediment combinations tested.
5. The API-type separator used to collect the washwater/oil/fines mixture leaving the rock washer at the perforated sections was effective in separating this mixture. Oil and emulsified oil separated from the water and floated to the surface, while fines collected at the bottom of the separator. The water, which was recycled and used for washing the test sediment contained between 26 and 256 ppm oil in water.
6. Overall, the materials and equipment chosen for this rock washer prototype were found to be adequately suited to this purpose.

7.2 RECOMMENDATIONS

1. This rock washer prototype is not mobile and is therefore limited in its applicability to actual beach cleanup operations. However, knowing that the concept tested is effective, construction of a mobile cobble washing device similar to the prototype tested, deserves serious consideration. One possibility would be to have the rock washer mounted on independent wheels, towed by a tractor and powered by the tractor's PTO.

2. Possible improvements to this prototype might include the following:
 - i) using diesel at the first spray nozzle to soften oil particularly in the case of sediment oiled with Bunker;
 - ii) decreasing the drum RPM's when washing Bunker from sediment - a longer wash cycle might improve output oil concentrations;
 - iii) increasing the water pressure - although the laboratory tests indicated this factor had only a small effect on the results obtained.

8.0 REFERENCES

Bocard, C., J.J. Quinquis and C. Such. 1987. A mobile plant prototype for the restoration of polluted beaches by washing oily sand. Proceedings of the 1987 Oil Spill Conference. USCG/API/EPA. Washington.

Bocard, C. 1990. Institut Francais du petrole, Personal Communication.

Huet, J.Y., Y. Naour, J.P. Belluteau, C. Bocard, C. Such and C. Vaillant. 1989. Operational use of a mobil sand-washing plant for cleaning pebbles: The Amazzone Spill. Proceedings of the 1989 Oil Spill Conference. USCG/API/EPA. Washington.

Jorgensen, A. 1990. A.J. Energy Inc., Personal Communication.

Marshbank, K. 1990. Northwest Processing Inc., Personal Communication.

Pasquet, R. and J. Denis. 1983. New developments in beach cleanup techniques. Proceedings of the 1983 Oil Spill Conference. USCG/API/EPA. Washington.

S.L. Ross Environmental Research Limited. 1984. An engineering study of mechanical shoreline cleanup systems for oil spills in Canada. Report to COOSRA. Calgary.

APPENDIX A

**DATABASE FOR COBBLE WASHERS
AND RELATED TECHNOLOGY**

(Submitted to Oil Spill Response Centre, Anchorage, Alaska)

Bishop	Bill	TACOMA BOATBUILDING CO.	1840 Marine View Dr.	Tacoma	Wa.	98422
Let.Code	Category	Sub-category				
D-1	Physical	Mechanical				
Comments: Incinerator vessel, forward to EXXON.						

Action: response ltr snt 12/15/90

Action date: -0-

McIntosh	Greg	MCINTOSH MARINE, Inc.	621 Idlewyld Drive	Ft. Lauderdale	Fla.	33301
Let.Code	Category	Sub-category				
D-1	Physical	Mechanical				
Comments: "Mailbox System" utilizes propwash to clean submerged intertidal. Has been used in Cook Inlet and Kachemak bay.(herring spawning) Also proposes using artificial kelp as interim habitat for flora and fauna normally associated with kelp. Tide dependant, question- able for treating:asphaltized oil;storm berm,depth of penetr						

Action: -0-

Action date: -0-

Marshbank	Ken	NORTHWEST PROCESSING. Inc.	P.O. Box 940 1707 Alexander Avenue	Tacoma	Wa.	98401-0940
Let.Code	Category	Sub-category				
A-1	Physical	Mechanical				
Comments: System works on a hydraulic pump principal and can be mounted on various vessels, or possibly work on shore. 1. Mechanically separates H2O wash/solvent 2. Rinse/return materials to beach. 3. Oil to separation barge then to incinerator barge. Maximum penetration of 3.5ft., volume cleaned proportional depth, &						

Action: Letter sent 12/15/90. Info. rcd. 1/16/90 head/max.material size,turbidity,penetration,and breaking the water/oil emulsion in the separation plant. Notice of TSC mtg snt 1/24/90.

Action date: -0-

Stacey	Dennis	CHUGACH ROCK CO.	P.O. Box 9-1219	Anchorage	Ak.	99509-1219
Let.Code	Category	Sub-category				
A-1	Physical	Mechanical				
Comments: Proposes to dredge substrate, move it to Anchorage, and replace with clean substrate. Offers storage or disposal (if it can be used for asphalt) of oiled substrate.						

Action: Reviewed. Notice of TSC mtg snt 1/24/90.

Action date: 11/13/89

Cox	Mrs. Jamie	Mad Dog Mine	2132 A Old Steese	Fairbanks	Ak.	99712
Let.Code	Category	Sub-category				
C-1	Physical	Mechanical				
Comments: Suction Dredge on floats, 7'x30".						

Action: Reviewed.

Action date: 11/21/89

Lee	Keith	-0-	Basil Boldridges Gravel Pit	-0-	Ak.	-0-
Let.Code	Category	Sub-category				
C-1	Physical	Mechanical				
Comments: Gravel and sediment washer, 40'x8', utilizes a rotating drum, screens, and steam.						

Action: Reviewed.

Action date: 11/25/89

Cook	Ray C.	-0-	2326 Cordova #14	Anchorage	Ak.	99503
Let.Code	Category	Sub-category				
E	Physical	Oil cleanup				
Comments: Rock washer plan using large pipe and melted down used tires.						

Action: Reviewed. Letter.

Action date: 12/15/89

Dean	Miles	HELO, Inc.	P.O. Box 201341	Anchorage	Alaska	99520
Let.Code	Category	Sub-category				
E	Mechanical	Oil cleanup				
Comments: Kelp and Fucus washing system (blue print - not to scale)						

Action: Reviewed, Letter.

Action date: 12/18/89

Hand	Al	PLACER EQUIPMENT & MFG.	P.O. Box 92304	Anchorage	Ak.	99509
Let.Code	Category	Sub-category				
A-1	Physical	Oil cleanup				
Comments: A portable rock/sediment washer using hot water(solvent injection possible) can be used on a beach or from barge. Large backhoe with 39 ft. reach delivers material a hopper, washes, re-deposits on beach, with oily water and slurry pumped to a settling barge.						

Action: Proposal recvd. 1/6/90. Reviewed, Lettersent 1/17/90. Notice of TSC mtg snt 1/24/90.

Action date: 01/16/90

Nadeau	Gary	Northwest Enterprises	9493 N Government Way	Hayden Lake	Idaho	83835
Let.Code	Category	Sub-category				
A-1	Physical	Incinerator				
Comments: Infra-red incinerator. Has one machine now in Calif. 7 months lead time to buildanother. Propane fired belt furnace,mentions firing oil at 550 deg but no mention of tar or asphalt capabilities. Calledno ans 2/6/90. 160/day, after-burner re-cycles gases, no ash. (2 48' semi trailers)						

Action: Notice of TSC mtg snt 1/24/90.

Action date: -0-

Wood	Larry	Magnum Resources International, Inc.	P.O. Box 1789	Palmer	Alaska	99645
Let.Code	Category	Sub-category				
A-1	Physical	Rock Washer				
Comments: Apparatus assisted by front-end loader, tumbles rock while being washed with hot water or hot water/chemical solution. 15 day lead time.						

Action: Reviewed. Response ltr snt 1/6/90 requesting more info. More info received 2/6/90 with photos. Upgraded to A-1.

Action date: 12/09/89

Edgett	Stephen	Cyclone Recycle Corp.	7323 West Roadway	New Orleans	Louisiana	70124
Let.Code	Category	Sub-category				
-0-	Mechanical	Incineration				
Comments: Rotary kiln incinerator with acid/gas scrubber system. 20-80 barrels of oil field cuttings per hour. In compliance with Louisiana State air quality regulations. Rec'd after TTSC meeting.						

Action: Reviewed, ltr of response snt. Physical file and R-base filecreated.

Action date: 05/09/90

Bannon	Robert	SURE-WAY Incinerator Co.	1621 E. 82nd Ave.	Anchorage	Ak.	99507
Let.Code	Category	Sub-category				
-0-	Physical	Incineration				
Comments: Portable cleaning system-Resulting material possibly useful as road material-Superheated water circulated through submerged material- 30 min. retention time-"hercable"-Recovery by centrifuge, gravity separation, and an additional sep. unit- Test results incl.-No capacity data.						
Action: Reviewed. CLE						
Action date: 06/09/90						

APPENDIX B

ROCKWASHER USER'S GUIDE

USER'S GUIDE

The rock washer prototype was designed to evaluate this concept as a useful aide in cleaning oil contaminated gravel/cobble shorelines. Although this prototype is portable (i.e., it can be disassembled into sections for transportation by helicopter or truck), as designed it is not mobile (i.e., cannot be moved along a beach without diassembing), which seriously limits its applicability to a shoreline cleanup operation. Material to be processed must be excavated, transported to the cobble washer, then returned to its original site.

In view of these limitations, it is recommended that this particular washer be used in very localized areas. The following guidelines have been set-up:

1. Start-up

- Diesel engine is started according to manufacturer's specifications. All connected equipment (water and diesel spray pumps, drum) will start up with the diesel, therefore all necessary hook-ups should be made prior to start-up.
- water temperature and spray nozzles can be adjusted after start-up. If cold water is used, it can be recycled from the separator back to the rock washer.

2. Loading

- Oiled beach material is shovelled or loaded by hand directly into the running washer. Alternatively, a trough can be set up in front of rock washer input to funnel the sediment into the washer. This task requires at least two people.

3. Unloading

- Processed sediment is shovelled away from the exit to avoid pile-up and obstruction of the drum rotation. The cleaned sediment can be shovelled into wheelbarrows and returned to its origin. Sediment which is not adequately cleaned is returned to the loading end of the rock washer and reprocessed.

4. Separator Tray

- The separator tray, collecting a mixture of washwater/oil/fines must be emptied periodically. Once the mixture settles the oil can be drawn off and sand and fines shovelled out. The oil and fines should be stored until proper disposal is arranged.

5. Safety

- Ear protection is recommended while operating this unit.

APPENDIX C

**ROCKWASHER BLUEPRINTS AND
EQUIPMENT SPECIFICATIONS**

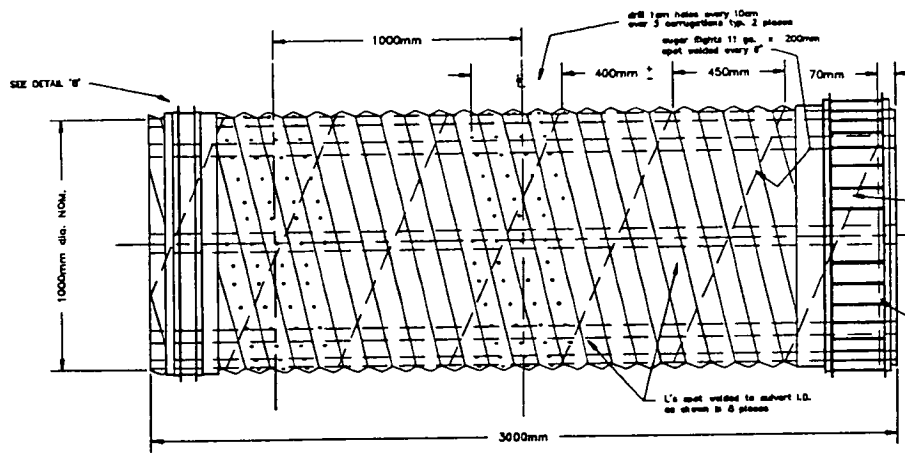

2 CORRUGATED CULVERT 1000mm dia. 1-REQ'D

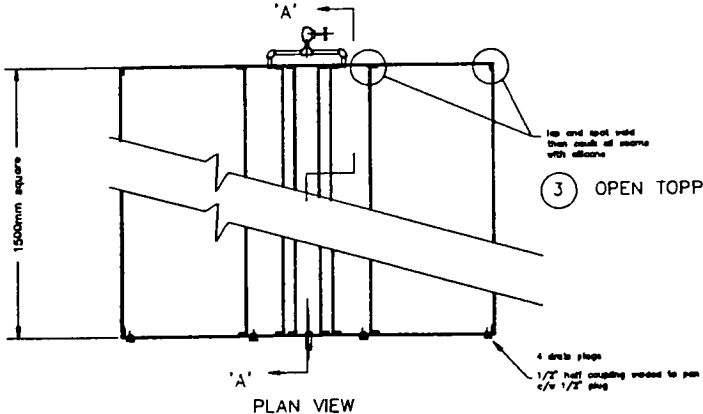
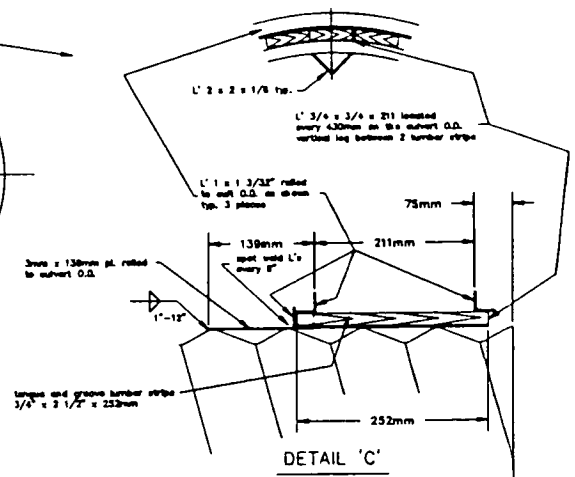
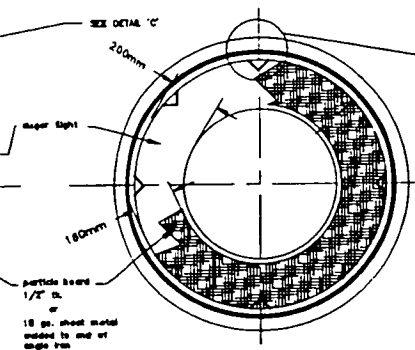

3 OPEN TOPPED OIL / WATER SEPARATOR 1-REQ'D

- MATERIALS:**
- 18 ga. sheet metal
 - 1 x 3/4" HPT ribplate
 - 4 x draft stops
 - 2 x 1/2" HPT ribplate
 - 2 x 1/2" HPT 90° elbows
 - 2 x 1/2" HPT connectors
 - 1 x 1/2" HPT tee
 - 1 x 1/2" HPT valve

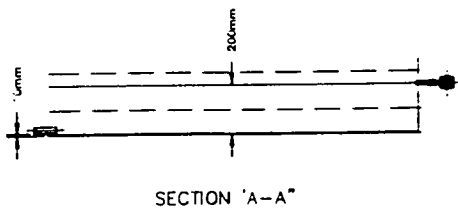
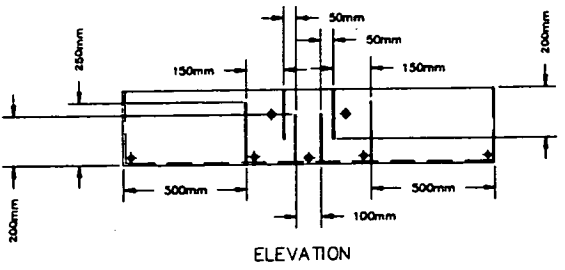
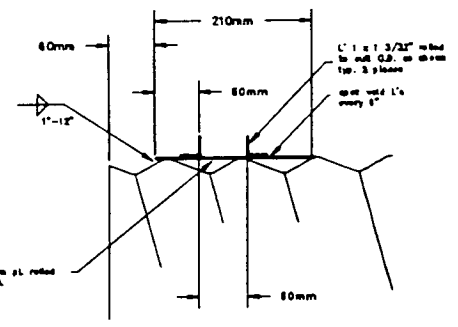

Revisions
Date
By

 SL ROSS <small>Environmental Research Limited</small>	S L Ross Environmental Research Limited
	ROCK WASHER
	BARREL AND OIL SEPARATOR PAN
	DETAILS
DATE: 27/10/96	SHEET-1 - D

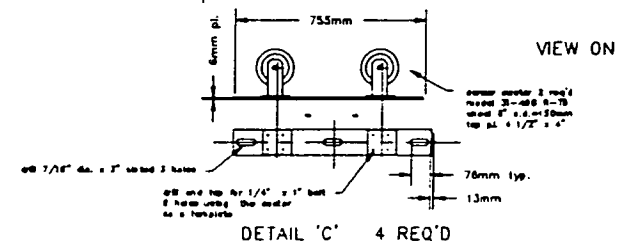
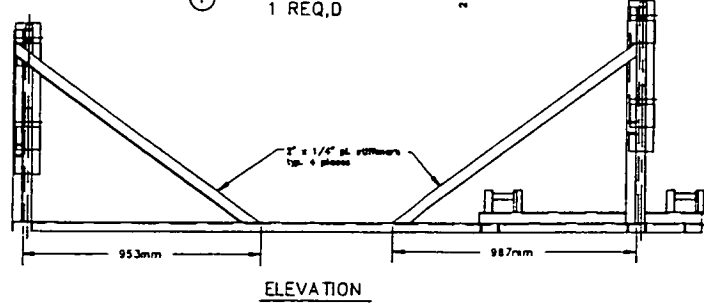
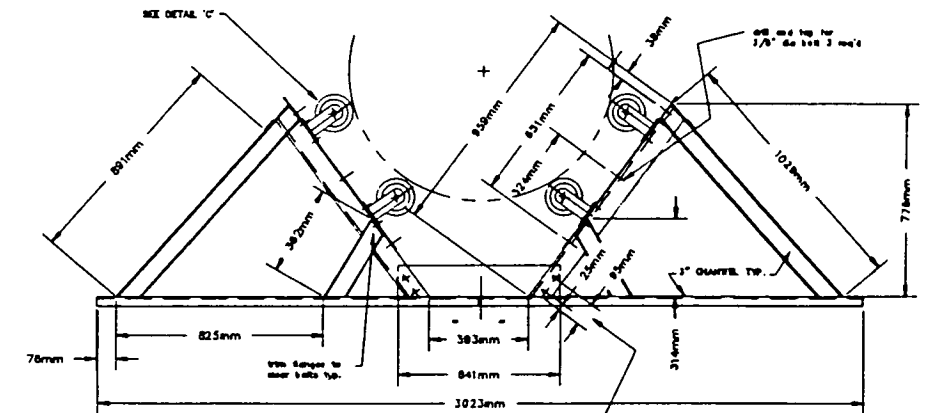
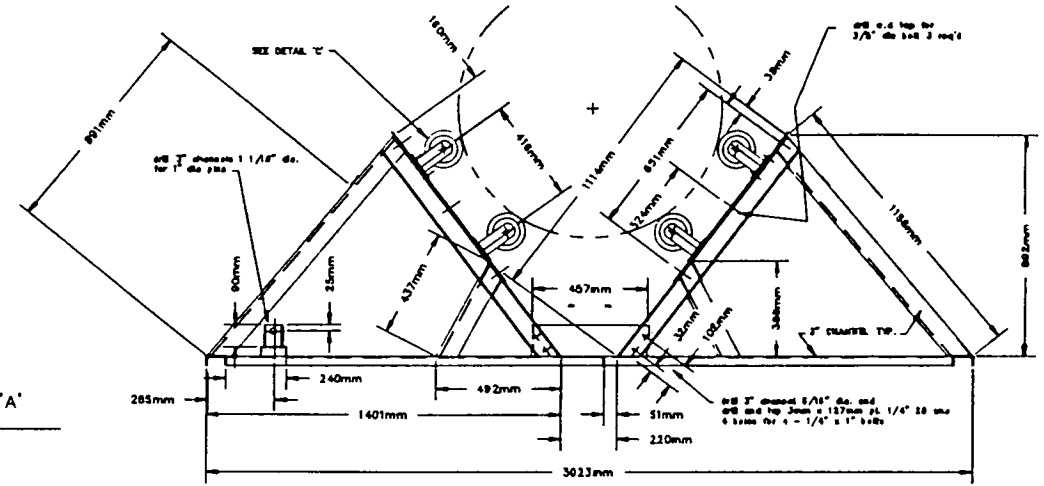
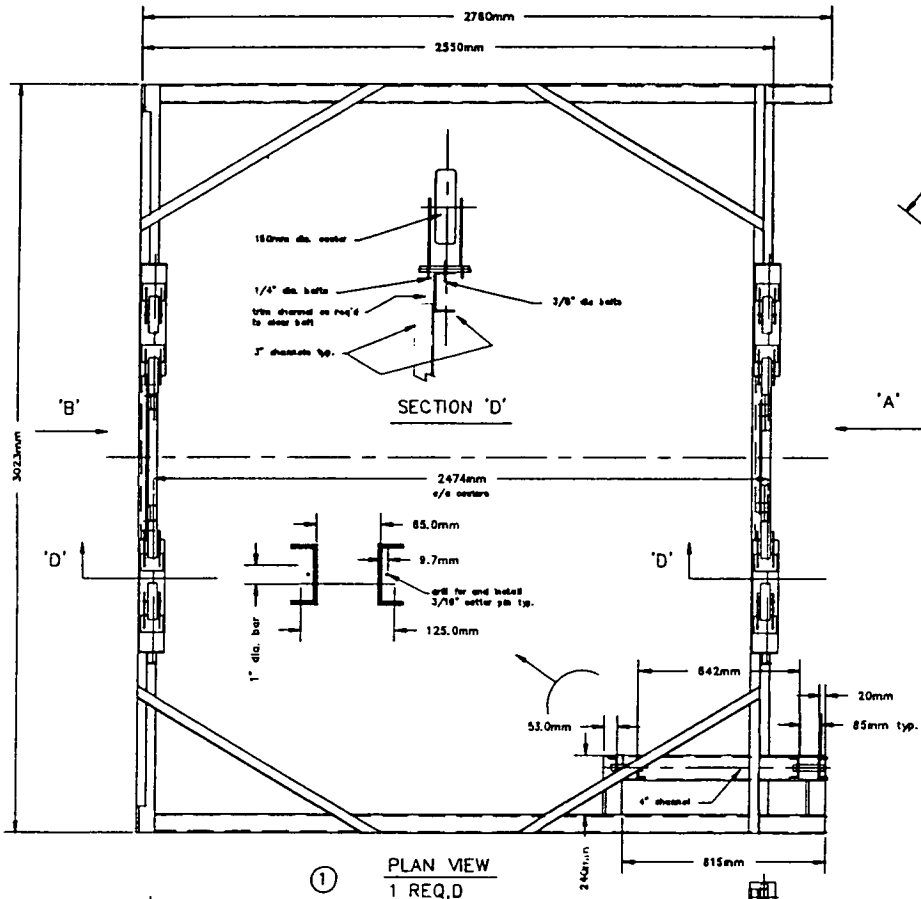

	S. L. Ross Environmental Research Limited	
	ROCK WASHER BARREL CRADLE ASSEMBLY AND DETAILS	
	Date: _____ Drawn by: _____ Checked by: _____ Approved by: _____	Scale: _____ No. of Sheets: _____ Sheet No.: _____
	SHEET-2-D	

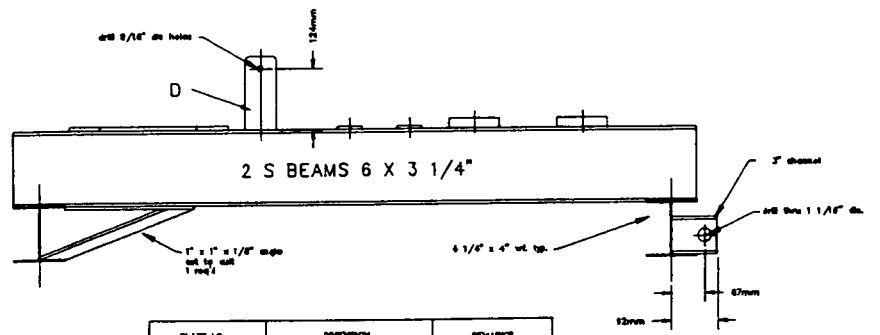
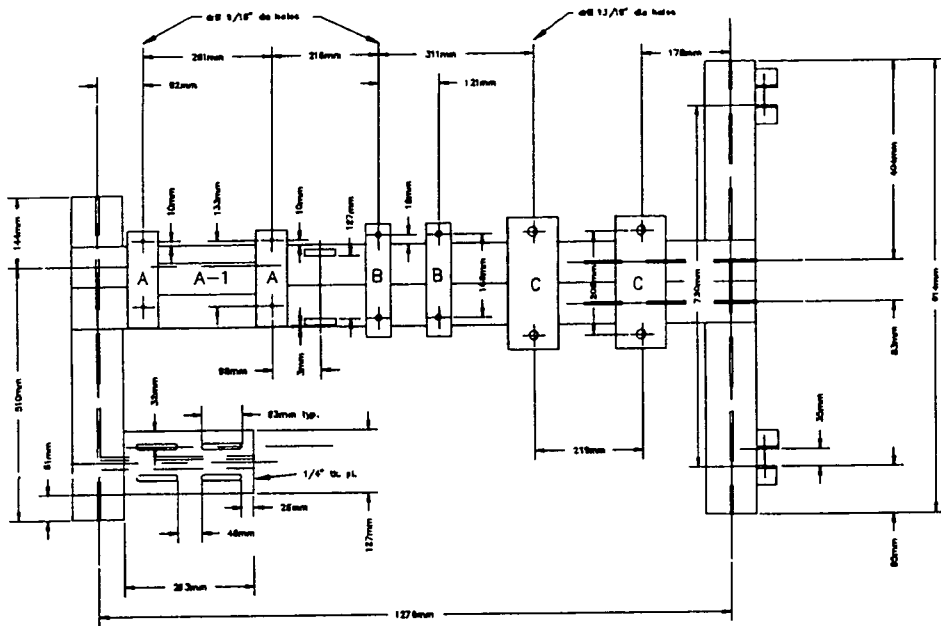
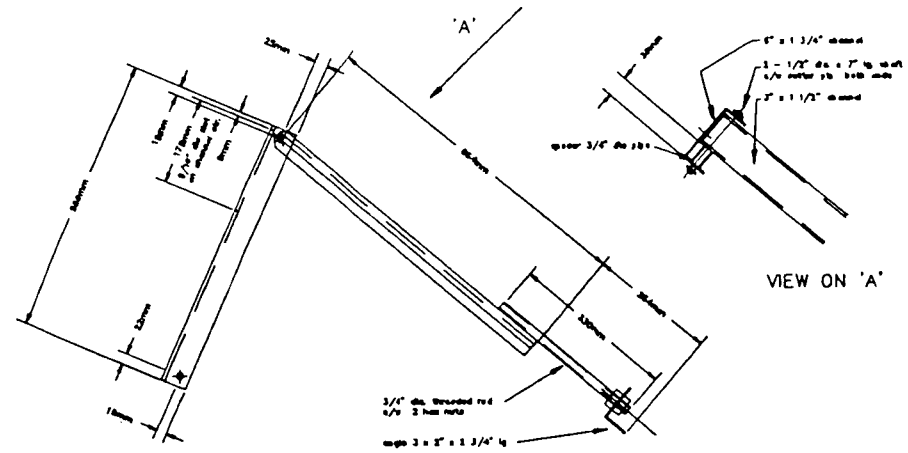
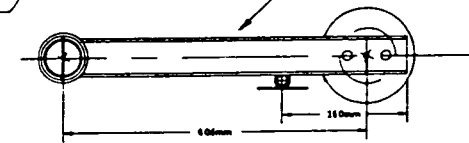
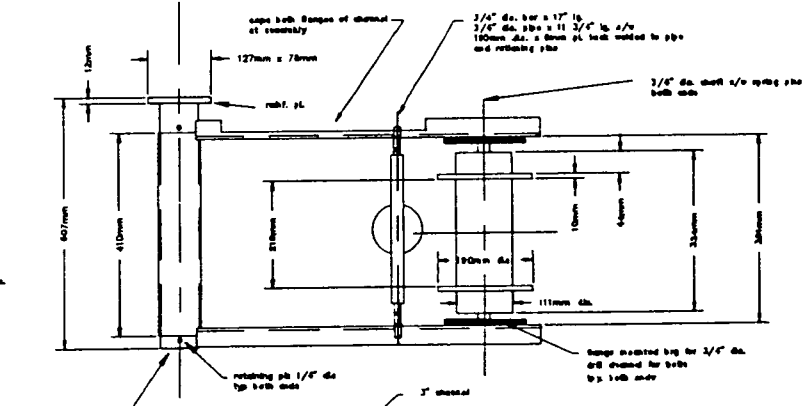

PLATE I.D.	DIMENSION	REMARKS
A	2 1/2" x 3 1/8" = 7 5/8"	welded to A-1
A-1	2 1/2" x 3 1/8" = 7 13/16"	welded to A
B	2" x 3 1/8" = 8 1/4"	welded to B' beam
C	4" x 3 1/4" = 10 1/2"	welded to C' beam
D	2 1/2" x 1 1/2" = 4 7/8"	welded to D' beam

④ DRIVE SUPPORT FRAME
1 REQ'D



⑤ PULLEY SUPPORT
1 REQ'D



⑥ DRIVE BELT IDLER
1 REQ'D

Revised By: _____
Date: _____

SL ROSS
S. L. Ross (Environmental Resources) Limited
ROCK WASHER
DRIVE
FABRICATED DETAILS
SHEET-J - D

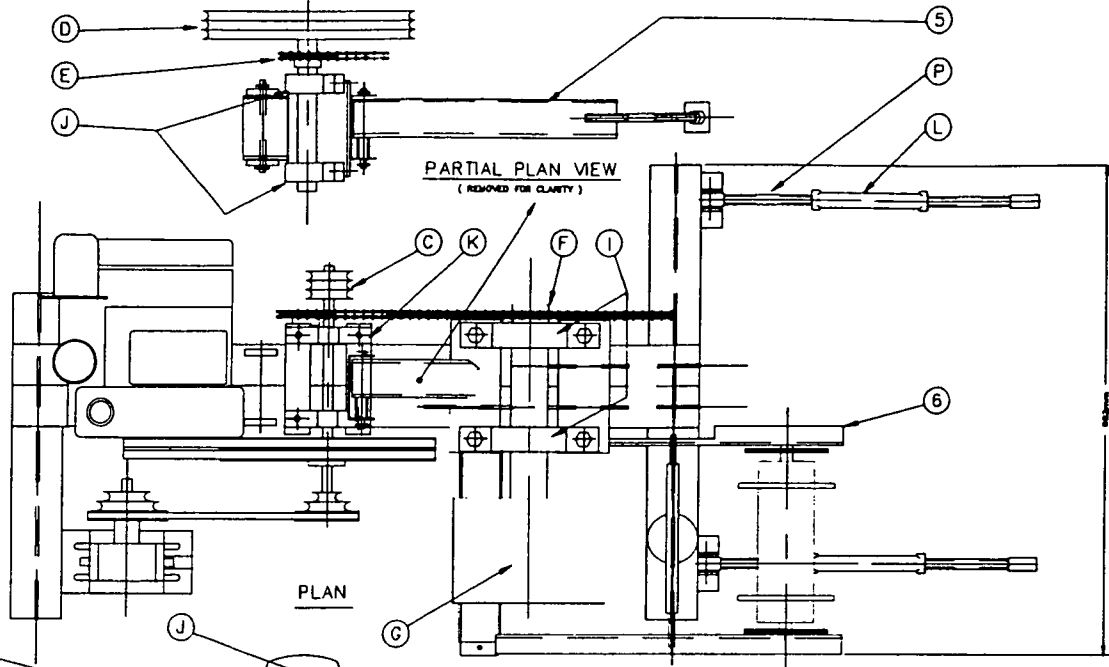

BILL OF MATERIAL			
ITEM	QTY	DESCRIPTION	REMARKS
A	1	38-40 x 3/4"	1/2" taper hub
B	1	38100 x 36 1 1/8"	1/2" taper hub
C	1	38-40 x 36 1 1/8"	1/2" taper hub
D	1	38160 x 36 1 1/2"	1/2" taper hub
E	1	38180 x 1 1/2"	1/2" nut approx
F	1	381115 SPACER SET ASSEMBLY 3 1/4"	weld to 2" taper hub
G	1	12 x 6 3/8 x 2" PLAT BEARING	1/2" taper hub
H	1	63618 PULLEY 1/2" SHAFT	1/2" bearing
I	2	UCP 275-40 3" PILLAR BLOCKS	
J	2	UCP 288-24 1 1/4" PILLAR BLOCKS	
K	2	UCP 288-12 1 1/8" PILLAR BLOCKS	
L	2	3/4" DIA. x 1" WRENCHABLE	
M	1	LESTER AIR COOLED DIESEL ENGINE	MODEL NO. L71
N	1	CAR SPIDER 150mm dia x 275mm hp	airflow 300 cfm
O	1	PSWP	see sheet 5
P	4	3/4" DIA. THREADED TE BPD	rebracketed
Q	1	DRIVE SUPPORT PLATE	see sheet 3
R	1	PULLY SUPPORT	see sheet 3
S	1	DRIVE BELT SLEEV	see sheet 2
MATERIAL NOT SPECIFIED			
SHAFTS: ALL SHAFT DIMENSIONS TO BE DETERMINED AT FABRIKATION			
V-BELTS: 1/2" V - BELTS x LENGTH TO SUIT AT ASSEMBLY			
DRIVE CHAIN: FOR ITEM V x LENGTH TO SUIT AT ASSEMBLY			
DRIVE BELT			

Revisions
 Date
 By



SL ROSS

S. L. Ross Environmental Resources Limited

**ROCK WASHER
DRIVE
ASSEMBLY AND DETAILS**

DATE	REV.	BY	APP.

SHEET-4 - D

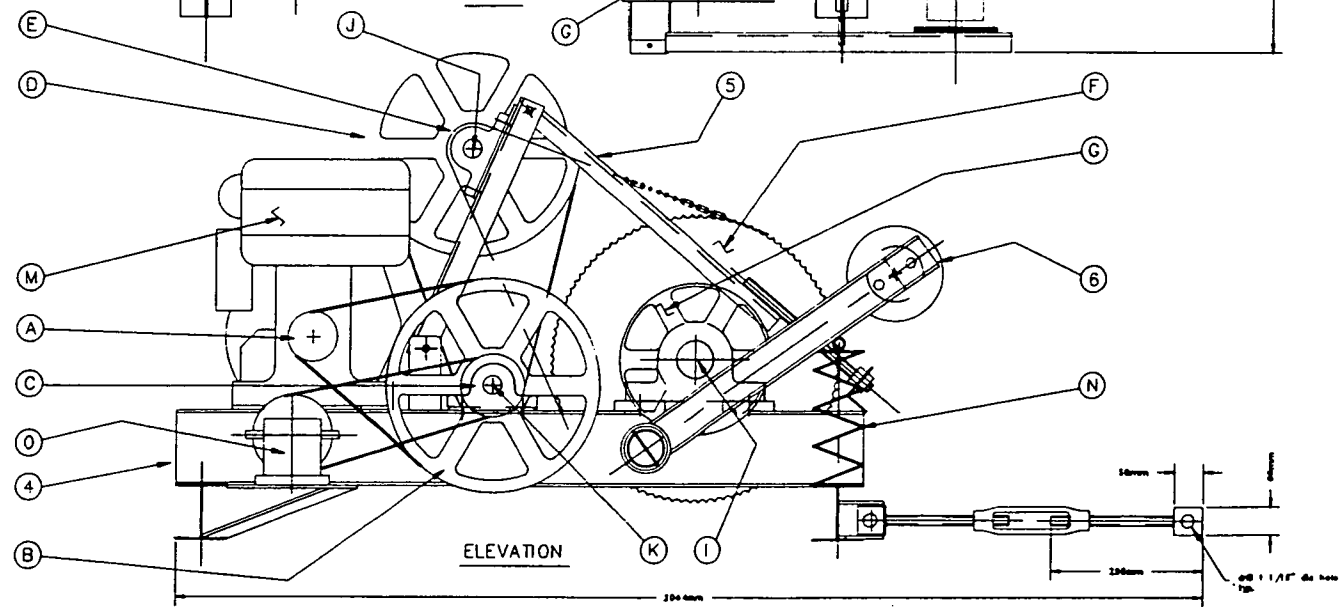

Lister

DIESELS

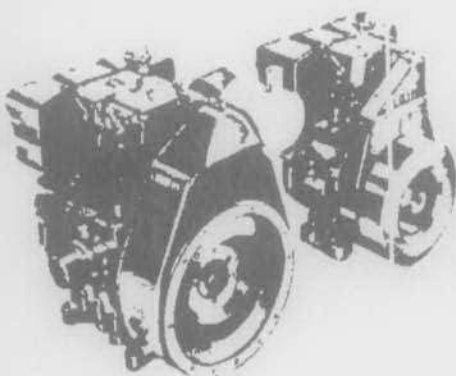

L RANGE AIR COOLED DIESELS 2.5-20bhp

SPECIFICATION

Cooling:

Air cooling is by means of a highly efficient flywheel mounted fan which provides continuous full load at temperatures up to 52°C.

Lubrication:

Self regulation plunger type pump supplies oil under pressure to all important bearing surfaces.

Governing: (BS 5514)

Engines can be supplied with either variable or constant speed governors - Class A1 or B1 according to build.

Starting: LV

Flush hand starting is fitted as standard with 12V electric starting as an option at extra cost.

Starting: LT

Hand starting on the camshaft extension. Geared starting provision at the flywheel end depending on the build. Electric starting optional.

Rotation: LV

Anti-clockwise looking on the flywheel. Clockwise looking on the flywheel. LV1 Build 09 only.

TECHNICAL DATA Power Output

Engine speed rev/min	Continuous bhp (BS649:1958 and 5514)			Intermittent power - cv (DIN 6270 'B')		
	LT1	LV1	LV2	LT1	LV1	LV2
3600	7.5			8.36		
3000	7.5	9.0	18.0	8.36	10.04	20.08
2500	6.7	7.8	15.6	7.47	8.70	17.40
2000	5.35	6.4	12.8	5.97	7.14	14.28
1800	4.8	5.75	11.5	5.35	6.41	12.83
1500	4.0	4.75	9.5	4.46	5.30	10.60
1000	2.5	2.9	-	2.79	3.23	-

Rotation: LT

Clockwise or Anti clockwise looking on the flywheel according to build.

	LT1	LV1	LV2
Bore: mm	82.55	85.73	85.73
Stroke: mm	76.2	82.55	
Cylinder Capacity: cm ³	408	477	953
Lubricating Oil Sump Capacity:	1.3 litre	3.6 litre	

Lubricating Oil Consumption:

Less than 0.75% of full load fuel consumption.

RATING

Note that 10% overload and DIN 'B' ratings apply to a fully run-in engine. This is normally attained after a period of approximately 50 hrs. running.

DERATING

Attitude: 3½% for every 300m above 150m above sea level.
Air Inlet Temperature: 2% for every 5½°C above 30°C.
Humidity: Up to a maximum of 6%.

Note: For some applications, speeds in excess of 3600 rev/min are required. Driven machinery must be suitable for operation at these higher speeds and the installation should be supervised by B. A. Lister.

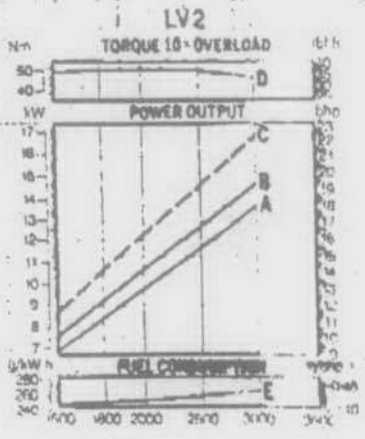
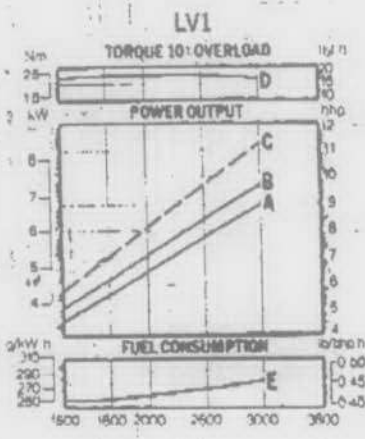
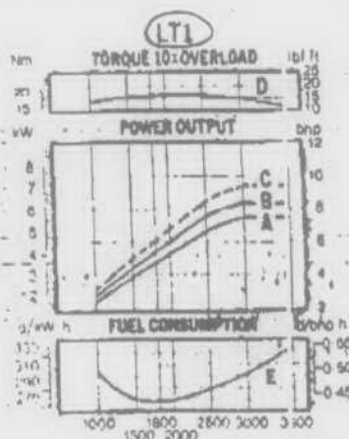

A. Continuous power to BS649 and 5514. B. Intermittent power to Din 6270 'B'. C. Maximum Gross Power. D. Torque - 10% overload and Din 6270 'B'. E. Fuel Consumption. These figures apply to fully run-in non derated, bare engines without power absorbing optional extras, transmissions, gearboxes etc. built, set and tested for each of the engine and its. Note: Flywheel mounted charging equipment when fitted will reduce engine power by between 3 and 6%.

Hypro

Two Cylinder

BIG TWIN^{T.M.} PISTON PUMPS

DELIVER VOLUME AND HIGH PRESSURE
NEEDED FOR EFFICIENT SPRAYING OR CLEANING

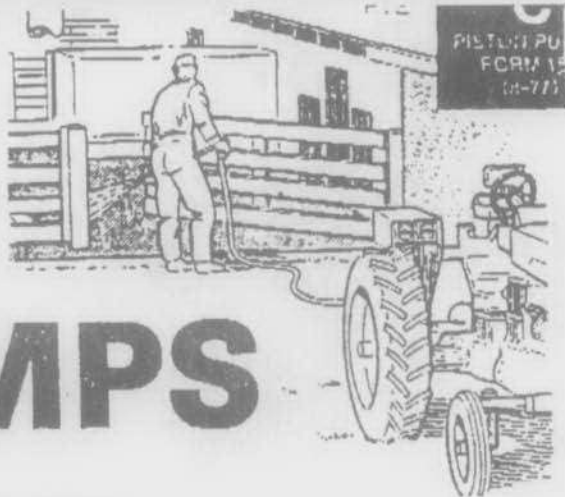

INLET VALVE
O-RING SEALS
OUTLET VALVE
PISTON ASSEMBLY
REPLACEABLE CYLINDER SLEEVE
OUTLET PORT 3/4" NPT
MAIN BEARING
GREASE FITTING
CAM BEARING
CONNECTING ROD
INLET PORT 3/4" NPT
MOUNTING BASE

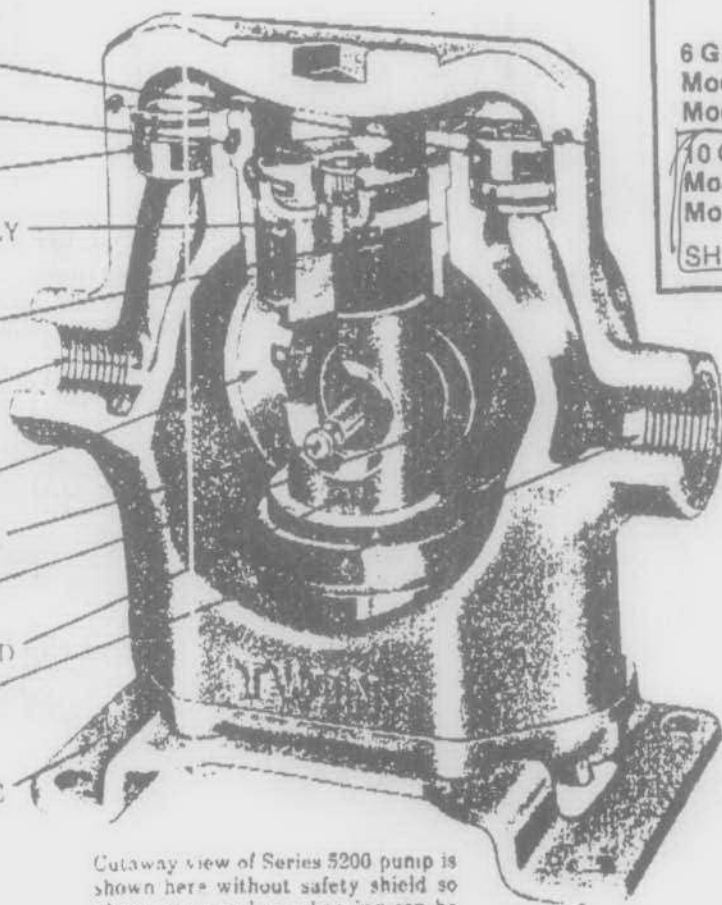

Cutaway view of Series 5200 pump is shown here without safety shield so piston parts and cam bearing can be seen. Do not operate pump without this shield in place.

TWO SIZES

6 GPM — up to 400 PSI
Model C5206N with 1" solid shaft
Model C5206HN with 1-3/8" PTO shaft

10 GPM — up to 400 PSI
Model C5210N with 1" solid shaft
Model C5210HN with 1-3/8" PTO shaft
SHIPPING WEIGHT EACH: 18 lbs

SPECIFICATIONS

VALVES: Stainless steel. Unitized. Suction and discharge identical, but installed in reverse order.

BEARINGS: Main Heavy Duty, double-row ball bearing. Factory lubricated. Cam sealed roller type, heavy duty. Equipped with LUBRI-DISC rings — permits 100-hr. greasing schedule.

PORTS: 3/4" NPT.

CRANKSHAFT: 1" solid steel for belt or flexible coupling drive. Hollow for direct mounting on standard 1-3/8" tractor PTO.

PISTON CUPS: Choice of leather or rubber impregnated fabric.

CONSTRUCTION: cast-iron housing and cylinder head. Electroless nickel plated available on special request.

Available in two sizes, the Hypro BIG TWIN^{T.M.} Piston Pump has top capacities of 6 and 10 gallons per minute, developing a maximum pressure of 400 psi (see performance table on other side).

Use it as a **sprayer pump** to apply a wide range of chemicals — including wettable powder suspensions — for weed or pest control. Use it as a **high pressure washer** to clean cars, trucks and other equipment; animal pens and farm buildings.

This versatile piston pump comes with your choice of piston cups — rubber impregnated fabric or leather. **Rubber cups** are used for water, soaps and detergent solutions. **Leather cups** are used for pumping insecticides, herbicides, aromatic solvents and other liquids injurious to rubber.

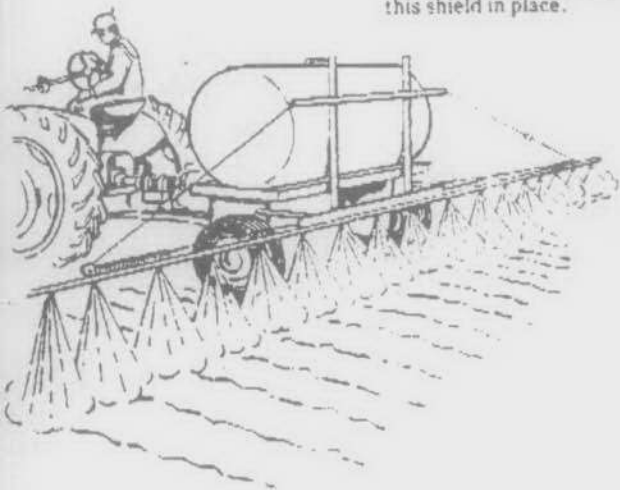



MOUNTING DIMENSIONS

IN INCHES

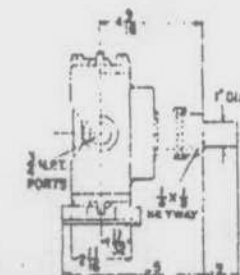
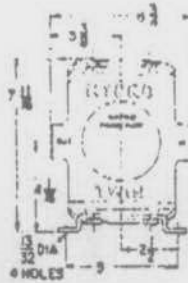

HOLLOW SHAFT MODELS
with stub shaft No. 1300-5

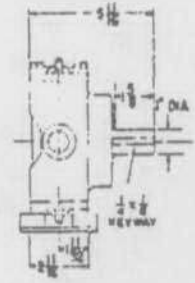

SOLID SHAFT MODELS

PERFORMANCE TABLES

Model 5206

SPEED (Rev. Per Minute)	PRESSURE -- In Pounds Per Square Inch									
	25		100		200		300		400	
	GPM	HP	GPM	HP	GPM	HP	GPM	HP	GPM	HP
400	3.83	.29	3.81	.37	3.80	.62	3.80	.88	3.68	1.10
500	4.85	.38	4.83	.49	4.82	.80	4.80	1.12	4.65	1.45
540	5.17	.40	5.15	.54	5.14	.84	5.12	1.20	5.00	1.50
600	5.85	.45	5.84	.60	5.83	.90	5.81	1.20	5.80	1.78
800*	7.48	.80	7.47	.75	7.45	1.12	7.44	1.65	---	---

Model 5210

SPEED (Rev. Per Minute)	PRESSURE -- In Pounds Per Square Inch									
	25		100		200		300		400	
	GPM	HP	GPM	HP	GPM	HP	GPM	HP	GPM	HP
400	7.79	.61	7.70	.81	7.58	1.12	7.45	1.60	7.35	2.1
500	9.30	.83	9.22	.95	9.12	1.32	9.00	1.80	8.90	2.32
540	9.92	.95	9.81	1.15	9.69	1.55	9.55	2.02	9.40	2.60
600	10.63	.98	10.55	1.19	10.41	1.59	10.30	2.13	10.18	2.83

PERFORMANCE

NOTE:

Test performed with one-foot suction lift, water at room temperature. Figures will vary with different installation. Horsepower shown is for electric motor. For gas engine, follow manufacturer's recommendations. Limit incoming pressure to 20 psi when equipped with suction side injector.

**At speeds over 600 RPM, limit pressure. Use 1-inch suction hose, large area strainer and high capacity relief valve.

1000 HOUR LUBRICATION

LUBRI-DISC Rings reduce friction within the cam bearing increasing bearing performance. Daily greasing schedule is NO LONGER NECESSARY. Lubricate cam bearing through grease fitting every 100 hours (or monthly, whichever comes first) with lithium No. 2 (an automobile grease available at all auto service stations). Main bearing is factory-lubricated, requiring no further servicing.

RECOMMENDED HOOK-UP

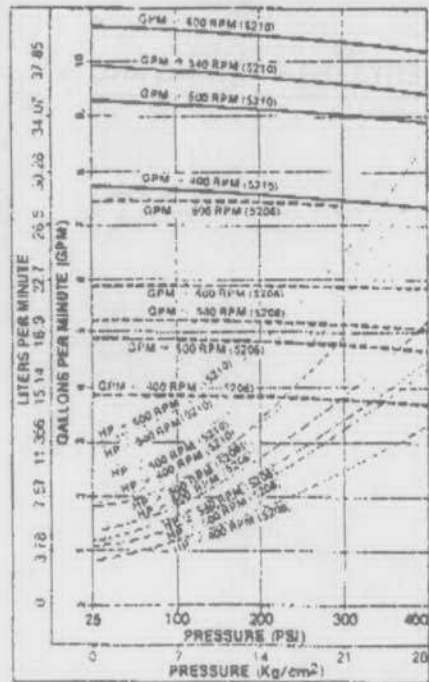
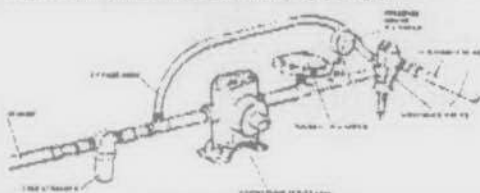

→ hollow shaft vs
→ don't over tighten belt

Hypro
A DIVISION OF LEAR SIEGLER, INC.
375 FERN Ave NW, St. Paul, MN 55112 • (612) 633-0300

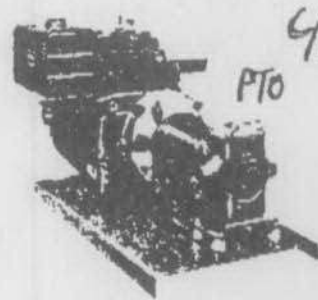

FOR ELECTRIC MOTOR OR GAS ENGINE DRIVE

Series 5200 pump can be powered by electric motor or gas engine with belt and pulley drive, or by direct flexible coupling drive and speed reducer (with motor or engine reduced to 600 RPM). Shown above is Hypro Spec. Unit No. 1181A with Model CS210N (Big Twin pump direct coupled to 7-HP Briggs and Stratton engine with speed reducer).

Hypro BIG TWIN™ PISTON PUMPS

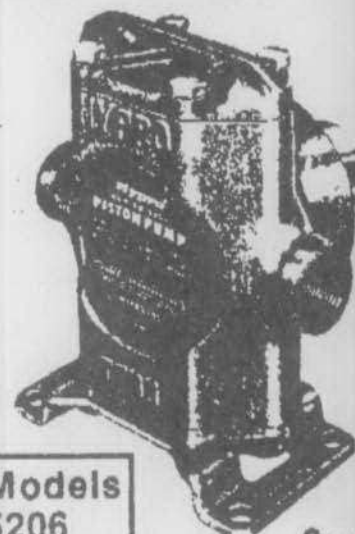

Models
5206
5210

6 a
GP

400 Series

250 per

CAPACITY: 400-1000 LBS. PER CASTER



31-406B-TD



31-406R-TD

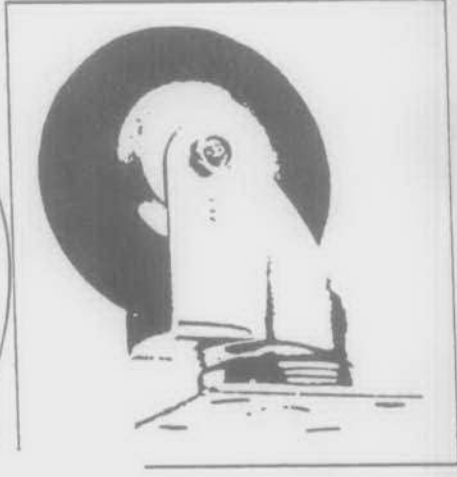

31-406-TD

Wheel Diameter	Wheel Width	Tread Width	Tread Material	Load Capacity	Bearing Type	Swivel Model	Rigid Model	Swivel Radius	Swivel Radius	Swivel Overall Height	Overall Height
----------------	-------------	-------------	----------------	---------------	--------------	--------------	-------------	---------------	---------------	-----------------------	----------------

DARCOR NEOPRENE - NON-MARKING AND NON-STAINING - USED ON ANY FLOOR SURFACE

4"	100	2"	50	Neoprene	Roller	31-404-TD	31-404R-TD	3-5/8"	92	5-5/8"	143
5"	125	2"	50	Neoprene	Roller	31-405-TD	31-405R-TD	4-1/4"	108	6-11/16"	170
5"	150	2"	50	Neoprene	Roller	31-406-TD	31-406R-TD	4-5/8"	117	7-11/16"	195
5"	200	2"	50	Neoprene	Roller	31-408-TD	31-408R-TD	5-3/4"	146	9-3/4"	248

DARCOR SOLID ELASTOMER - VERY LOW STARTING AND ROLLING RESISTANCE

3"	75	2"	50	Solid Elastomer	Roller	31-403-TSE	31-403R-TSE	3-1/4"	83	4-3/4"	121
4"	100	2"	50	Solid Elastomer	Roller	31-404-TSE	31-404R-TSE	3-5/8"	92	5-5/8"	143
4"	100	2"	50	Solid Elastomer	Roller	31-404-TSE	31-404R-TSE	3-5/8"	92	5-5/8"	143
4"	100	2"	50	Solid Elastomer	Roller	31-404-TSE	31-404R-TSE	3-5/8"	92	5-5/8"	143
5"	125	2"	50	Solid Elastomer	Roller	31-405-TSE	31-405R-TSE	4-1/4"	108	6-11/16"	170
5"	125	2"	50	Solid Elastomer	Roller	31-405-TSE	31-405R-TSE	4-1/4"	108	6-11/16"	170
5"	150	2"	50	Solid Elastomer	Roller	31-406-TSE	31-406R-TSE	4-5/8"	117	7-11/16"	195
5"	150	2"	50	Solid Elastomer	Roller	31-406-TSE	31-406R-TSE	4-5/8"	117	7-11/16"	195
5"	200	2"	50	Solid Elastomer	Roller	31-408-TSE	31-408R-TSE	5-3/4"	146	9-3/4"	248

DARCOR SEMI-STEEL - CROWNED SEMI-STEEL CASTING

3"	75	1-7/8"	48	Semi-Steel	Roller	31-403-TCI	31-403R-TCI	3-1/4"	83	4-3/4"	121
4"	100	1-7/8"	48	Semi-Steel	Roller	31-404-TCI	31-404R-TCI	3-5/8"	92	5-5/8"	143
5"	125	1-7/8"	48	Semi-Steel	Roller	31-405-TCI	31-405R-TCI	4-1/4"	108	6-11/16"	170
5"	150	1-7/8"	48	Semi-Steel	Roller	31-406-TCI	31-406R-TCI	4-5/8"	117	7-11/16"	195
5"	200	1-7/8"	48	Semi-Steel	Roller	31-408-TCI	31-408R-TCI	5-3/4"	146	9-3/4"	248

DARCOR V-GROOVED - ECONOMICAL HANDLING OF HEAVY LOADS ON ANGLE TRACK

4"	100	2"	50	V-Groove	Roller	31-404-TGV	31-404R-TGV	3-5/8"	92	5-5/8"	143
5"	125	2"	50	V-Groove	Roller	31-405-TGV	31-405R-TGV	4-1/4"	108	6-11/16"	170

FRAMES - Available on 3", 4" and 5" Swivel Models. Add letter B for Swivel and Wheel FOUR POSITION SWIVEL LOCKS - Add letter F FRAMES and SWIVEL LOCKS CANNOT BE COMBINED ON SAME CASTER

ATT: CHANTAL S.L. ROSS ENVIRONMENTAL LTD



L RANGE AIR COOLED DIESELS

STANDARD EQUIPMENT LT1, LV1 & 2.

Air cleaners, Exhaust silencer, Fuel filter, Fuel tank (not build 22 LT1), Governor, Oil filter (LV2), Starting handle, Automatic excess fuel (LV2), Self venting fuel system (LV1), Operators handbook and parts list.

PRINCIPAL DIMENSIONS mm

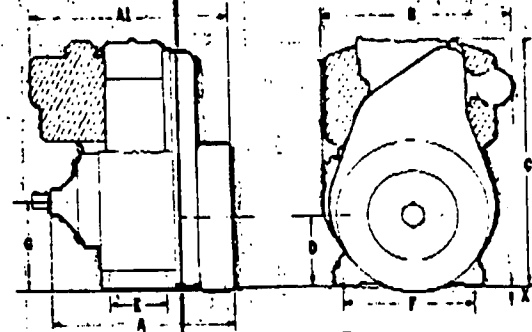

ACCESSORIES

- Air cleaners - Med. duty - Heavy duty (LV2)
- Controls - speed, stopping and shut down solenoid
- Cooling air outlet duct adaptor
- Flywheel and gear end drives, extension shafts, couplings, - pulleys (LT1)
- Flywheel adaptors - SAE5, J609B
- Fuel equipment - tanks, fuel filter
- Fuel lift pump (LV2)
- Guards (LT)
- Starting equipment - hand, 12V electric
- Recommended spares
- Packing, manuals, tools

	LT1	LV1	LT1	LV1	LV2
	Sheetmetal fanshroud		Cast fanshroud		
A:	-	353	-	357	492
Al:	398	398	402	402	537
B:	388	371	444	424	440
C:	495	503	495	503	540
D:	140		140		183
E:	112		112		226
F:	260		260		263
G:	175		175		218
X:	10		38		-

SHIPPING SPECIFICATION: (Basic engine)

	LT1/LV1	LV2
Nett Weight kg	83(92)*	126
Gross Weight kg	97(106)*	152
Volume m ³	0.17	0.34

*With cast fanshroud.

The information given is intended for the assistance of users and is based upon results obtained from tests carried out at the place of manufacture. This company does not guarantee that the same results will be obtained elsewhere under different conditions. Prices and specifications are subject to amendment without notice and all information is given subject to the Company's current Conditions of Tender and Sale.

HAWKER SIDDELEY LISTER DIESELS

R. A. LISTER & CO. LTD., DURSLEY, GLOUCESTERSHIRE, GL1 14HS, ENGLAND. TEL: DURSLEY (0453) 4141. TELEX: 43261. CABLES: MACHINERY DURSLEY.

Hawker Siddeley Group supplies electrical and mechanical equipment with world-wide sales and service.

MECHANICAL CONSULTING & REPAIR
ANTRIM
P.O. KINBURN
KOA 2HO
812-2052

HYPRO

Two Cylinder

BIG TWIN^{T.M.} PISTON PUMPS

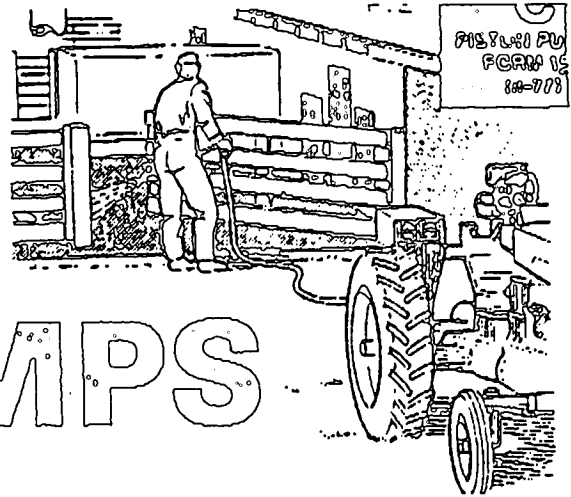

DELIVER VOLUME AND HIGH PRESSURE
NEEDED FOR EFFICIENT SPRAYING OR CLEANING

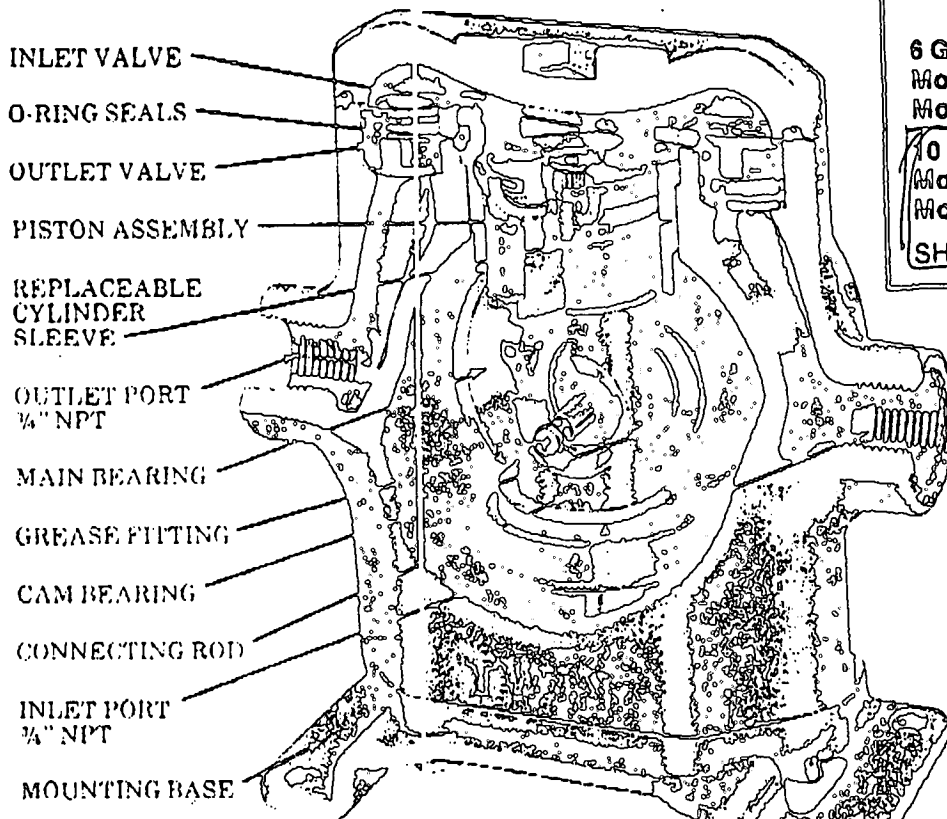

Cutaway view of Series 5200 pump is shown here without safety shield so piston parts and cam bearing can be seen. Do not operate pump without this shield in place.

TWO SIZES

6 GPM — up to 400 PSI
Model C5206N with 1" solid shaft
Model C5206HM with 1-3/8" PTO shaft

10 GPM — up to 400 PSI
Model C5210N with 1" solid shaft
Model C5210HM with 1-3/8" PTO shaft

SHIPPING WEIGHT EACH: 18 lbs

SPECIFICATIONS

VALVES: Stainless steel. Unitized. Suction and discharge identical, but installed in reverse order.

BEARINGS: Main Heavy Duty, double-row ball bearing. Factory lubricated. Cam sealed roller type, heavy duty. Equipped with LUBRI-DISC rings — permits 100-hr. greasing schedule.

PORTS: 3/4" NPT.

CRANKSHAFT: 1" solid steel for belt or flexible coupling drive. Hollow for direct mounting on standard 1-3/8" tractor PTO.

PISTON CUPS: Choice of leather or rubber impregnated fabric.

CONSTRUCTION: cast-iron housing and cylinder head. Electroless nickel plated available on special request.

Available in two sizes, the Hypro BIG TWIN[™] Piston Pump has top capacities of 6 and 10 gallons per minute, developing a maximum pressure of 400 psi (see performance table on other side).

Use it as a sprayer pump to apply a wide range of chemicals — including wettable powder suspensions — for weed or pest control. Use it as a high pressure washer to clean cars, trucks and other equipment; animal pens and farm buildings.

This versatile piston pump comes with your choice of piston cups — rubber impregnated fabric or leather. Rubber cups are used for water, soaps and detergent solutions. Leather cups are used for pumping insecticides, herbicides, aromatic solvents and other liquids injurious to rubber.

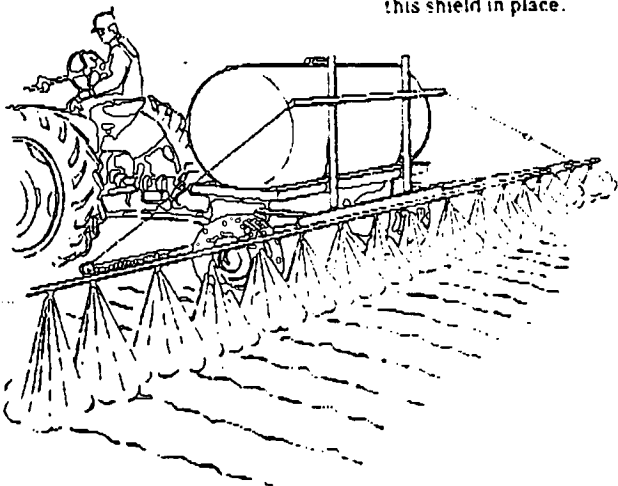

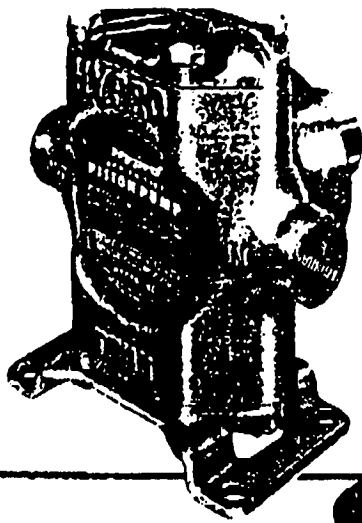

MOUNTING DIMENSIONS

IN INCHES

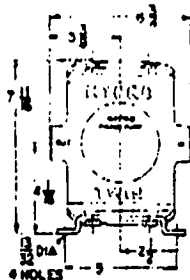

HOLLOW SHAFT MODELS
with stub shaft No. 1300-5

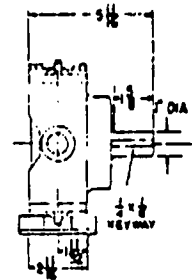

SOLID SHAFT MODELS

PERFORMANCE TABLES

Model 5206

SPEED (Rev. Per Minute)	PRESSURE -- In Pounds Per Square Inch									
	25		100		200		300		400	
	GPM	HP	GPM	HP	GPM	HP	GPM	HP	GPM	HP
400	3.83	.29	3.81	.37	3.80	.62	3.80	.88	3.68	1.10
500	4.85	.36	4.83	.49	4.82	.80	4.80	1.12	4.65	1.45
540	5.17	.40	5.15	.54	5.14	.84	5.12	1.20	5.00	1.50
600	5.85	.45	5.84	.60	5.83	.90	5.81	1.20	5.80	1.78
800*	7.48	.80	7.47	.75	7.45	1.12	7.44	1.65	—	—

Model 5210

SPEED (Rev. Per Minute)	PRESSURE -- In Pounds Per Square Inch									
	25		100		200		300		400	
	GPM	HP	GPM	HP	GPM	HP	GPM	HP	GPM	HP
400	7.79	.61	7.70	.81	7.58	1.12	7.45	1.60	7.35	2.1
500	9.30	.83	9.22	.95	9.12	1.32	9.00	1.80	8.90	2.32
540	9.92	.95	9.81	1.15	9.69	1.55	9.55	2.02	9.40	2.60
600	10.63	.98	10.55	1.19	10.41	1.59	10.30	2.13	10.18	2.83

PERFORMANCE

NOTE:

Test performed with one-foot suction lift, water at room temperature. Figures will vary with different installation. Horsepower shown is for electric motor. For gas engine, follow manufacturer's recommendations. Limit incoming pressure to 20 psi when equipped with suction side injector.

**At speeds over 600 RPM, limit pressure. Use 1-inch suction hose, large area strainer and high capacity relief valve.

100 HOUR LUBRICATION

JUBRI-DISC Rings reduce friction within the cam bearing increasing bearing performance. Daily greasing schedule is NO LONGER NECESSARY. Lubricate cam bearing through grease fitting every 100 hours (or monthly, whichever comes first) with Lubri-Disc No. 2 (an automobile grease available at all auto service stations). Main bearing is factory-lubricated, requiring no further servicing.

RECOMMENDED HOOK-UP

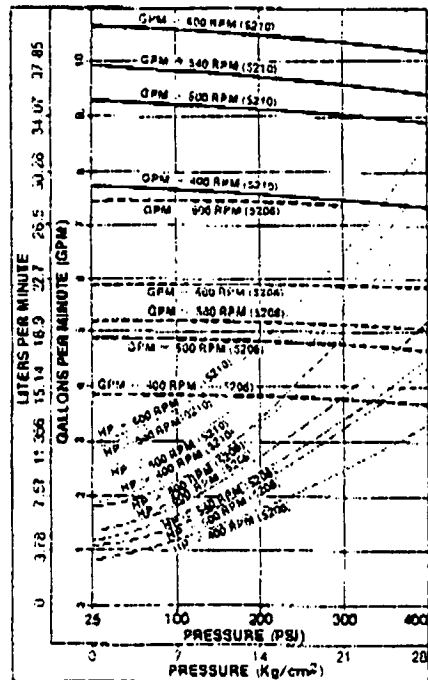
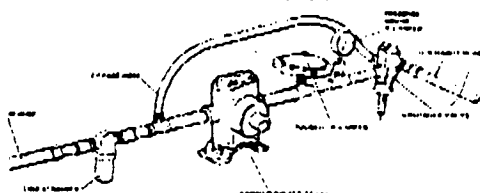

→ hollow shaft vs
→ don't over tighten belt

Hyp
A DIVISION OF LEAR SIEGLER, INC.

375 FIRM Ave NW, St. Paul, MN 55112 • (612) 633-0300

PRINTED IN USA (XG)

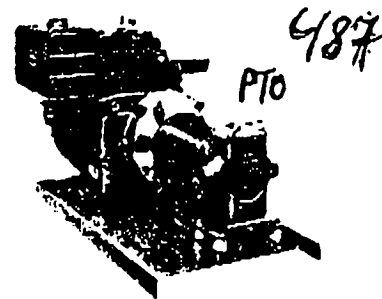

FOR ELECTRIC MOTOR OR GAS ENGINE DRIVE

Series 5200 pump can be powered by electric motor or gas engine with belt and pulley drive, or by direct flexible coupling drive and speed reducer (with motor or engine reduced to 600 RPM). Shown above is Hypro Spec. Unit No. 1181A with Model C5210N (Big Twin pump direct coupled to 7-HP Briggs and Stratton engine with speed reducer).

Hyp

BIG TWIN™ PISTON PUMPS

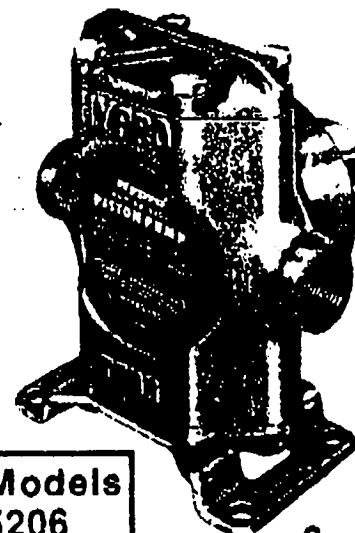

Models
5206
5210

6 a
GP

400 Series

CAPACITY: 400-1000 LBS. PER CASTER

250 per

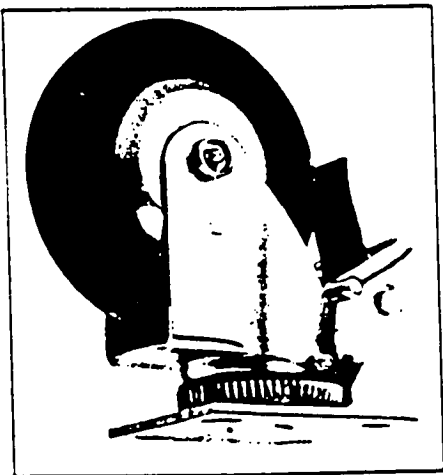

31-406B-TD

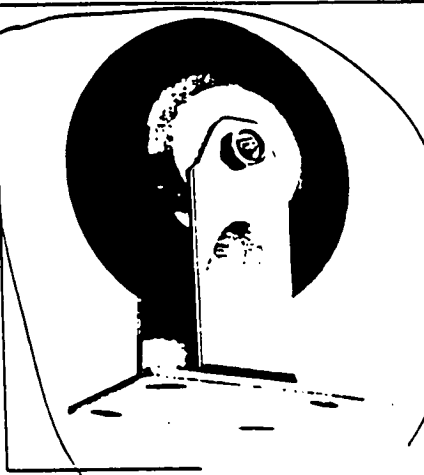

31-406R-TD

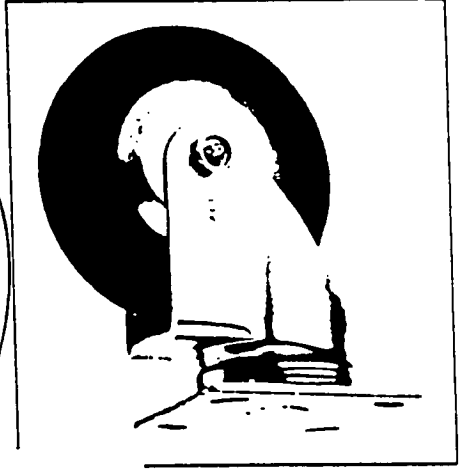

31-406-TD

Wheel Diameter	Wheel Width	Tread	Material	Capex Capex	Load Type	Swivel Model	Rigid Model	Swivel Radius	Swivel Rad/mm	Swivel Overall Hght/mm	Overall
----------------	-------------	-------	----------	-------------	-----------	--------------	-------------	---------------	---------------	------------------------	---------

DARCOR NEOPRENE - NON-MARKING AND NON-STAINING - USED ON ANY FLOOR SURFACE

4"	100	2"	50	Neoprene	400	182	31-404-TD	31-404R-TD	3-5/8"	92	5-5/8"	143
5"	125	2"	50	Neoprene	450	205	31-405-TD	31-405R-TD	4-1/4"	108	6-11/16"	170
5"	150	2"	50	Neoprene	500	227	31-406-TD	31-406R-TD	4-5/8"	117	7-11/16"	195
5"	200	2"	50	Neoprene	500	227	31-408-TD	31-408R-TD	5-3/4"	146	9-3/4"	248

DARCOR SOLID ELASTOMER - VERY LOW STARTING AND ROLLING RESISTANCE

3"	75	2"	50	Solid Elastomer	900	409	31-403-TSE	31-403R-TSE	3-1/4"	83	4-3/4"	121
4"	100	2"	50	Solid Elastomer	900	409	31-404-TSE	31-404R-TSE	3-5/8"	92	5-5/8"	143
4"	125	2"	50	Solid Elastomer	1000	455	31-405-TSE	31-405R-TSE	4-1/4"	108	6-11/16"	170
5"	125	2"	50	Solid Elastomer	1000	455	31-406-TSE	31-406R-TSE	4-5/8"	117	7-11/16"	195
5"	150	2"	50	Solid Elastomer	1000	455	31-408-TSE	31-408R-TSE	5-3/4"	146	9-3/4"	248

DARCOR SEMI-STEEL - CROWNED SEMI-STEEL CASTING

3"	75	1-7/8"	48	Semi-Steel	300	409	31-403-TCI	31-403R-TCI	3-1/4"	83	4-3/4"	121
4"	100	1-7/8"	48	Semi-Steel	1000	455	31-404-TCI	31-404R-TCI	3-5/8"	92	5-5/8"	143
5"	125	1-7/8"	48	Semi-Steel	1000	455	31-405-TCI	31-405R-TCI	4-1/4"	108	6-11/16"	170
5"	150	1-7/8"	48	Semi-Steel	1000	455	31-406-TCI	31-406R-TCI	4-5/8"	117	7-11/16"	195
5"	200	1-7/8"	48	Semi-Steel	1000	455	31-408-TCI	31-408R-TCI	5-3/4"	146	9-3/4"	248

DARCOR V-GROVED - ECONOMICAL HANDLING OF HEAVY LOADS ON ANGLE TRACK

4"	100	2"	50	V-Groove	300	364	31-404-TCV	31-404R-TCV	3-5/8"	92	5-5/8"	143
5"	125	2"	50	V-Groove	1000	455	31-405-TCV	31-405R-TCV	4-1/4"	108	6-11/16"	170

SPAKES - Available on 31" and 3" Swivel Models. Add letter B, Locks Swivel and Wheel FOUR POSITION SWIVEL LOCKS - Add letter F. Stakes and Swivel Locks cannot be combined on same caster.



This publication is printed on paper containing recovered waste.