

This document was produced  
by scanning the original publication.

Ce document est le produit d'une  
numérisation par balayage  
de la publication originale.



**GEOLOGICAL SURVEY  
OF CANADA**

**PAPER 70-1**  
Part B

**REPORT OF ACTIVITIES,**  
Part B: November 1969 to March 1970

**DEPARTMENT OF ENERGY, MINES AND RESOURCES**

© Crown Copyrights reserved  
Available by mail from the Queen's Printer, Ottawa

from the Geological Survey of Canada  
601 Booth St., Ottawa

and

Canadian Government bookshops in  
HALIFAX - 1735 Barrington Street  
MONTREAL - 1182 St. Catherine Street West  
OTTAWA - Corner Mackenzie and Rideau  
TORONTO - 221 Yonge Street  
WINNIPEG - 499 Portage Avenue  
VANCOUVER - 657 Granville Street  
or through your bookseller

Price: \$1.50

Catalogue No. M44-70-1B

Price subject to change without notice

Queen's Printer for Canada  
Ottawa  
1970

CONTENTS

	Page
INTRODUCTION .....	1
ANALYTICAL CHEMISTRY	
1. SYDNEY ABBEY: Atomic absorption spectroscopy .....	2
2. W. H. CHAMP: Application of spectrochemical methods to trace element determinations in geological materials ....	2
3. J. G. SEN GUPTA: Preconcentration of microgram amounts of the rare earths for determination by instrumental methods .....	3
4. J. G. SEN GUPTA: Determination of carbon by non-aqueous titration using a high-frequency induction furnace: Application to rocks, stony meteorites and metallurgi- cal samples .....	4
CORDILLERAN GEOLOGY	
5. D. C. FINDLAY: Magnetic elements of Anvil Range area, Yukon (105 K, 105 J) .....	5
6. E. W. MOUNTJOY: Northeast corner McBride map-area, British Columbia (93 H) .....	9
7. J. E. MULLER, R. A. RAHMANI: Upper Triassic sediments of Northern Vancouver Island .....	11
8. D. J. TEMPELMAN-KLUIT: An occurrence of eclogite near Tintina Trench, Yukon .....	19
EXPLORATION GEOPHYSICS (also see report number 35)	
9. R. H. AHRENS: Electrical and magnetic field absorption meter .....	23
10. A. BECKER, A. V. DYCK: Time-domain em theory .....	25
11. MARGARET E. BOWER: Use of the Omega radionavigation system for ocean aeromagnetic surveys .....	26
12. B. W. CHARBONNEAU, A. G. DARNLEY: A test strip for calibration of airborne gamma-ray spectrometers .....	27

CONTENTS (cont'd)

	Page
13. B. W. CHARBONNEAU, A. G. DARNLEY: Radioactive precipitation and its significance to high-sensitivity gamma-ray spectrometer surveys .....	32
14. K. W. CHRISTIE, R. M. SCHAEFFER, E. J. SCHWARTZ: A vibrating-sample magnetometer .....	36
15. PETER HOOD, MARGARET E. BOWER: Aeromagnetic profile from Cape Cargenholm, Baffin Island to Red Head, West Greenland .....	37
16. T. S. KATSUBE: Electrical rock properties .....	39
17. L. OSTRIHANSKY: Spectra from a high resolution Ge(Li) detector .....	42
18. W. S. SCOTT, C. GAUVREAU: A variable low-frequency power signal generator .....	45
LUNAR STUDIES	
19. J. A. MAXWELL: Lunar crust investigation .....	47
METAMORPHIC PETROLOGY	
20. E. W. REINHARDT, G. B. SKIPPEN: Petrochemical study of Grenville granulites .....	48
MINERAL DEPOSITS	
21. O. R. ECKSTRAND: Serpentinites as potential sources of nickel .....	55
22. R. V. KIRKHAM: Some copper occurrences in younger sedimentary rocks of the Coppermine River area, Northwest Territories .....	57
23. E. R. ROSE: Uranium and vanadium content of assorted rocks in Canada .....	63
24. D. F. SANGSTER: Geology of Canadian lead and zinc deposits .....	64
MINERALOGY	
25. C. R. MCLEOD: Reflectance, microindentation hardness and rotation properties of opaque minerals .....	66

CONTENTS (cont'd)

	Page
26. J. Y. H. RIMSAITE: Study of mica-group minerals and host rocks .....	66
QUATERNARY RESEARCH AND GEOMORPHOLOGY	
27. E. B. OWEN: Stereomapping of the face of the American falls .....	70
28. M. L. PARKER: Some new techniques used in dendrochronological investigations in Canada .....	73
29. W. W. SHILTS: Geochemical anomalies in till, southeastern Quebec .....	74
STRATIGRAPHY	
30. HELEN R. BELYEA: Significance of an unconformity within the Chinchaga Formation, northern Alberta and north-eastern British Columbia .....	76 ✓
31. T. P. CHAMNEY: Biostratigraphic subdivision of the first Mackenzie River delta exploratory borehole .....	80 ✓
32. LUBOMIR F. JANSÁ: Stratigraphy and sedimentology of the Ordovician and Lower Devonian strata in Pine Pass map-area, British Columbia .....	83 ✓
33. C. J. YORATH: Cretaceous and Tertiary stratigraphy, Caribou Hills, District of MacKenzie - A correction ....	88 ✓
GENERAL	
34. G. H. EISBACHER: Regionalization of crustal stresses in Canada: Assessment of techniques .....	89
EXPLORATION GEOPHYSICS	
35. R. M. GAGNE, GEORGE D. HOBSON: A hammer seismic survey of an esker north of Peterborough, Ontario, 31 D/8 .....	91



ABSTRACT

This report comprises thirty-five short papers that describe research carried out by members of the Geological Survey of Canada between November 1969 and March 1970. Some are illustrated by photographs and line drawings.



The American Falls at Niagara as they appeared during the summer of 1969. See Article 27.



## REPORT OF ACTIVITIES, NOVEMBER 1969 TO MARCH 1970

---

### INTRODUCTION

The thirty-five papers that comprise this report describe briefly some of the work carried out by members of the Geological Survey between November 1969 and March 1970. Some of these reports are in the nature of "reports of progress", others are complete though brief statements on some aspect of geological research and others are designed to "alert" earth scientists about the Geological Survey's current approach to certain research problems. The figures used to illustrate this publication are reproduced without change from material supplied by the authors. Manuscripts were accepted for inclusion in this report until 1 May, 1970.

The Report of Activities (parts A and B), the reports on isotopic and radiocarbon dating, the annual index of publications and the volume of abstracts of papers published by Survey personnel in non-Survey publications provide an annual accounting of most of the scientific work of the Branch. Requests for announcement cards, geological reports, maps or information on specific areas or topics should be addressed to: Geological Survey of Canada, Department of Energy, Mines and Resources, 601 Booth Street, Ottawa, 4, Canada.

ANALYTICAL CHEMISTRY

*General*

1. ATOMIC ABSORPTION SPECTROSCOPY

Project 690090

Sydney Abbey

The new 'lithium fluoborate' decomposition scheme described in Paper 69-1, Part B has been extended to most of the major and minor elements of silicate rocks, having been applied to the determination of Si, Al, total Fe, Mg, Ca, Na, K, Mn and Cr (where present in more than trace amounts). For most of the elements, precision and accuracy are comparable to those obtainable by conventional methods, and speed is greatly improved. For such elements as Al and Ca, when present in unusually small concentrations, in the presence of a large excess of iron and/or magnesium, the proposed scheme is more reliable than are conventional methods. For Al in the more usual range, results are somewhat inferior to those of the older methods; for Si, even more so, but still superior to X-ray fluorescence values.

2. APPLICATION OF SPECTROCHEMICAL METHODS  
TO TRACE ELEMENT DETERMINATIONS  
IN GEOLOGICAL MATERIALS

*General*

Project 690090

W.H. Champ

A quantitative analytical procedure has been established for the determination of some 35 trace elements in iron base materials, e. g. pyrite, pyrrhotite, magnetite, hematite, etc. The elements currently determinable, and the approximate limits of determination are:

<.001%	Ag, Sc, Yb
.001-.002%	Ba, Be, Co, Cu, Cr, Mg, Mn, Ni, Sr, Ti, V, Y
.003-.005%	Ge, La, Nb
.01-.02%	Ca, Mo, Nd, Si, Sn, W, Zr
.03-.05%	Al, B, Bi, Ce, Pb
.07-.1%	As, Cd, Sb, Zn

A minimum of 50 milligrams of representative sample is required. Precision obtained is  $\pm 15$  per cent of amount reported, or better.

3. PRECONCENTRATION OF MICROGRAM AMOUNTS  
OF THE RARE EARTHS FOR DETERMINATION  
BY INSTRUMENTAL METHODS

Project 690090

J. G. Sen Gupta

The development work for preconcentration of the rare earths from rocks prior to determination by instrumental methods, as described in a previous report<sup>1</sup>, was continued. A small Dowex 1-X8 anion-exchange resin (50-100 mesh) column (8 cm by 1.6 cm) was used to separate the rare earths from synthetic mixtures approximating the composition of 1 gram and 2 grams of acidic and basic rocks. A total of 75 millilitres of a mixture of 90 per cent acetic acid and 10 per cent 5 N nitric acid was used to wash the column for removal of traces of Al, Ca and Mg impurities. The rare earths were desorbed from the column by washing with 200 millilitres of 1 N nitric acid and precipitated as basic sebacates<sup>2</sup> in presence of aluminium and colloidal silica (LUDOX) as carriers. After ignition to oxides, they were analyzed by a spectrographic method. The results indicated quantitative recoveries for Ce, La, Nd, Y and Yb.

In order to study whether all other traces of the rare earths in rocks are determinable by X-ray fluorescence and/or spectrographic methods after preliminary concentration by anion-exchange resin, synthetic solutions containing amounts of Y, La, the rare earths (excepting Pm) corresponding to those in 1 gram and 2 grams of the U. S. G. S. standard rocks were prepared. The rare earths, Y and La were precipitated in the presence of Al and colloidal SiO<sub>2</sub> (LUDOX) as carriers by the method of Carron *et al.*<sup>2</sup> After filtration and washing, the precipitate was ignited to oxide and a portion analyzed by X-ray fluorescence methods against synthetic standards prepared identically. Preliminary results indicate that excepting Y, all rare earths including La are determinable by X-ray fluorescence methods. Yttrium can be determined by a spectrographic method.

---

<sup>1</sup> Sen Gupta, J. G.: Preconcentration of microgram amounts of the rare earths in rocks for determination by instrumental methods, in Report of Activities, November 1968 to March 1969; Geol. Surv. Can., Paper 69-1, Part B, p. 3 (1969).

<sup>2</sup> Carron, M. K., Skinner, D. L. and Stevens, R. E.: Determination of thorium and rare-earth elements in cerium earth minerals and ores; Anal. Chim. Acta, vol. 28, p. 1 (1955)

---

4. DETERMINATION OF CARBON BY NON-AQUEOUS TITRATION  
USING A HIGH-FREQUENCY INDUCTION FURNACE: APPLICATION  
TO ROCKS, STONY METEORITES AND METALLURGICAL SAMPLES

*Research*  
Project 690090

J. G. Sen Gupta

The determination of carbon in a wide variety of samples requires a sufficiently rapid and accurate method. The conventional gravimetric method involves collection of carbon dioxide evolved during combustion (total carbon) or acid treatment (carbonate carbon) of the sample, in a pre-weighed absorption tube containing Ascarite and magnesium perchlorate and weighing again, the difference being equal to the weight of carbon dioxide absorbed. For determining small amounts of carbon dioxide in rocks, this method suffers from some uncertainty because it involves measuring a small difference in weight (i. e. a fraction of a mg) in an absorption tube which may weigh over 100 grams. This cumbersome gravimetric procedure was replaced by developing a suitable nonaqueous titration method.

For the determination of total carbon in rocks, stony meteorites and metallurgical samples, the method involves ignition of the sample mixed with iron chips and vanadium pentoxide in a current of oxygen in a high-frequency induction furnace; the carbon dioxide liberated is absorbed in a solution of acetone containing 0.6 per cent monoethanolamine and an excess of sodium methylate. After reaction the excess sodium methylate is back titrated by a standard methanolic solution of benzoic acid using phenolphthalein as the indicator. For the determination of total carbon in carbonate ores and carbides, acetone in the above solution was replaced by a 1:1 mixture of acetone and methanol.

The above nonaqueous titration method has been extended to the determination of carbon dioxide in rocks, clay and limestones by the acid evolution method.

Reliable results up to 47 per cent total carbon dioxide were obtained by this method. Details will be published elsewhere.

CORDILLERAN GEOLOGY

5.           MAGNETIC ELEMENTS OF ANVIL RANGE AREA,  
              YUKON (105 K, 105 J)

Project 690092

D. C. Findlay

Four-mile magnetic compilation maps of the general Anvil Range area (105 K - Tay River; 105 J - Sheldon Lake) show a number of anomalous features. Figure 1 (see Geol. Surv. Can., Geophysics Papers 7839G (Tay River) and 7838G (Sheldon Lake)) shows generalized airborne magnetic data for Tay River and western part of Sheldon Lake sheets. Superposed on the regional magnetic gradient (decreasing from east to west) are several magnetic features of presumably more localized origin. Tintina Trench is marked by a magnetically subdued belt (not shown on Fig. 1) which is bordered on the northeast by a chain of sublinear positive anomalies that are undoubtedly related to Pennsylvanian-Permian volcanic rocks and scattered serpentinized peridotite bodies (Tempelman-Kluit, 1968).

Extending through the area in a northerly direction are a number of magnetic discontinuities that are, in part, functions of changes in trends of the regional magnetic 'belts' (shown in Fig. 1 at 100-gamma intervals), but that must be partly also due to other causes. The most pronounced of these elements extends through the approximate centre of the area from near the junction of Ross and Pelly Rivers (south of Fig. 1 boundary), across MacMillan River and into adjacent Lansing map-sheet (105 N) to the north (see Geol. Surv. Can., Geophysics Paper 7853G). Between Ross and Tay Rivers, the feature is delineated by a southerly flexure of the regional magnetic trend; north of Tay River its extension is traced by a series of generally northerly-trending positive magnetic anomalies, in places separated by less pronounced north-trending magnetic depressions. The overall effect of the regional and local magnetic components delineates a strong sublinear magnetic feature that is, in part, discordant to the magnetic 'grain' of the area as well as discordant to regional geological trends. Although not shown on Figure 1 the magnetic element terminates to the south at Tintina Trench.

Similar, although less well-defined magnetic discontinuities seem to be present about 25 miles and 50 miles east of the central magnetic element. A fourth element, marked principally by a south-trending bend in the regional magnetic trend may be present about 25 miles to the west, north of Mount Mye.

The significance of the north-trending magnetic elements is not known. It is noteworthy that their trends are parallel to magnetic survey flight-line directions, and thus spurious results might be expected due to contouring procedures. For example, the feature marked by the chain of small positive anomalies immediately east of Ross River is confined to a single flight-line width. A choice of contour geometry that would emphasize north-westerly trending axes of these small anomalies might change the pattern in

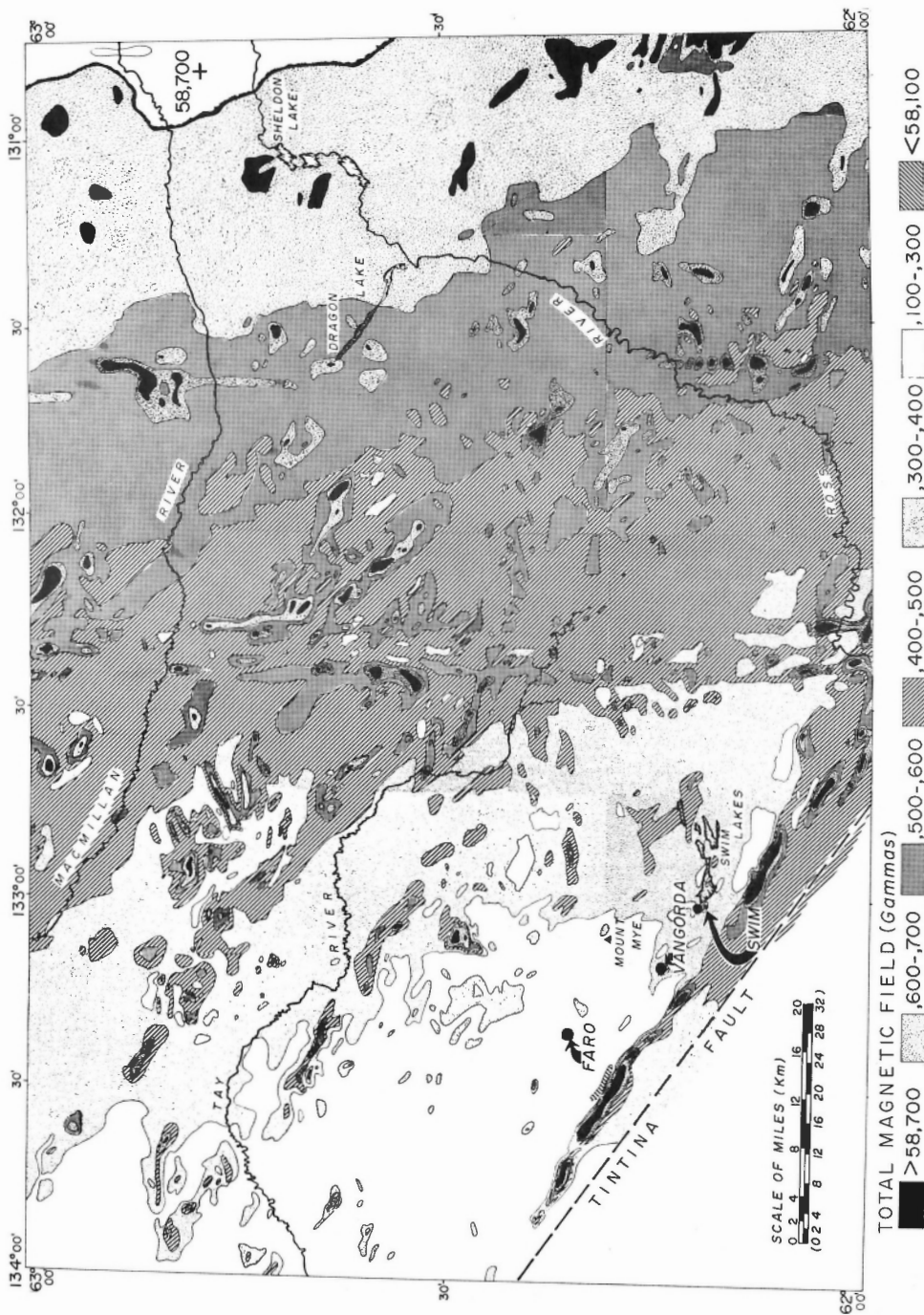

Figure 1. Generalized total magnetic field data for Tay River and western part of Sheldon Lake map-sheets, Yukon.

this area in detail, although a pronounced northerly orientation of the overall element would remain. On the other hand, the parts of the magnetic elements that are traced by flexures in regional magnetic trends are not easily explained by contour geometry.

The north-trending magnetic elements of Anvil Range area are only partly correlative with surface geological features. As shown on Figure 2, the principal magnetic element crosses an area underlain from south to north by: Pennsylvanian-Permian volcanic rocks; Cretaceous and 'Tertiary' acidic intrusive rocks and intermediate to mafic volcanic rocks; various sedimentary strata, chiefly of Devono-Mississippian age; Cretaceous acidic intrusive rocks; and, part of the Proterozoic(?) 'Grit Unit' assemblage. The volcanic and plutonic rocks were originally assigned a Tertiary age by Roddick and Green<sup>1</sup> however, subsequent K-Ar age determinations on the volcanic rocks have yielded Cretaceous ages<sup>2</sup>. In general, rock units and structures (bedding, schistosity) trend west-northwest. Between MacMillan and Tay Rivers, the irregular magnetic pattern lying west of the main north-trending magnetic feature is probably correlative with the distribution of younger (Cretaceous) volcanic rocks. To the east of the magnetic element, correlation between the distribution of volcanic rocks and magnetic activity is not as exact, and part of the area may be underlain by sedimentary rocks (Devono-Mississippian). It is possible however, that small positive anomalies of this area may be correlative with scattered, plug-like mafic igneous bodies that may represent feeders to volcanic piles, subsequently removed by erosion. Although not reported from this particular locality, such 'feeders' are known elsewhere in Anvil area, as for example, northwest of the Faro Mine.

In summary, the apparently strongly discordant magnetite features of Anvil Range area may be due only to a fortituous combination of shifts in regional magnetic trends, local geological features (chiefly volcanic), and magnetic contouring geometry. One other possibility, of a highly speculative nature might be considered. This concerns the orientation of the northerly-trending magnetic features with respect to orientation of Tintina Trench. On Figure 2, known faults<sup>1, 3</sup> are shown, as well as a few faults inferred from local geology. A number of weak magnetic sublineaments are also shown, most of which seem parallel to known fault directions. In general, these features combine to suggest a rectilinear pattern whose principal directions are approximately northwest (parallel to Tintina Trench) and northeast. Roddick<sup>4</sup> concluded that Tintina Trench is the surface expression of a major (transcurrent) fault with right-lateral movement of the order of 220 to 260 miles. Such a fault or fault zone should (as noted by Roddick, *op. cit.* p. 29) have theoretical associated tension directions of approximately north-south orientation. A major crustal shear of the magnitude of Tintina Fault might be expected to generate proportionately large associated tension fractures. Thus, the possibility might be entertained that the north-trending magnetic discontinuities of Anvil Range area are magnetic expressions of tensional elements associated with Tintina Fault.

---

<sup>1</sup> Roddick, J. A. and Green, L. H.: Tay River map-area, Yukon Territory; Geol. Surv. Can., Map 13-1961 (1961).

<sup>2</sup> Lowdon, J. A., Stockwell, C. H., Tipper, H. W. and Wanless, R. K.: Age determinations and geological studies, K-Ar Isotopic Ages, Rept. 3; Geol. Surv. Can., Paper 62-17 (1963).

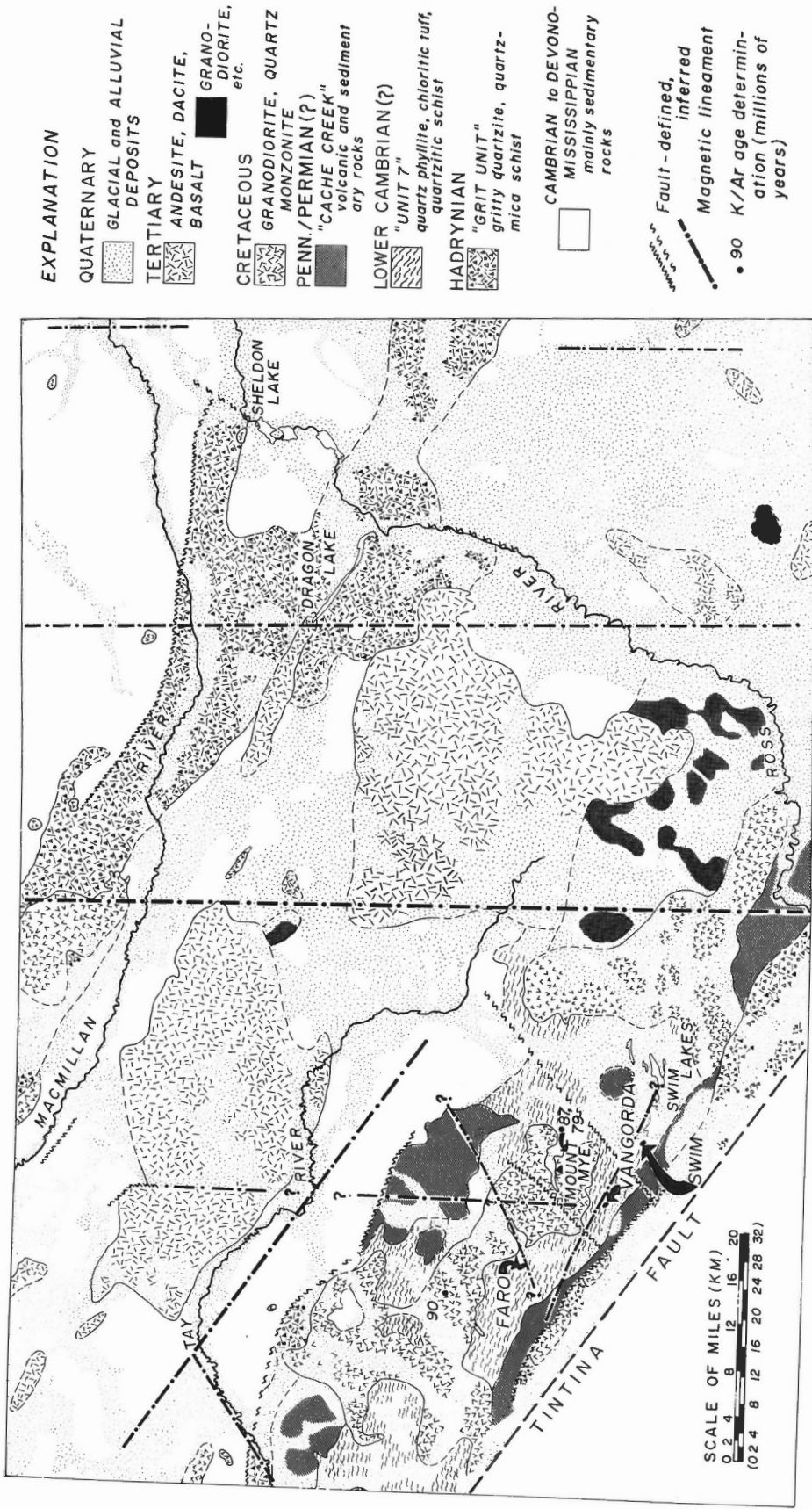

Figure 2. Geological sketch of Anvil Range area (after Tempelman-Kluit, 1968; Roddick and Green, 1961).



<sup>3</sup> Tempelman-Kluit, D. J.: Geological setting of the Faro, Vangorda and Swim base metal deposits, Yukon Territory; Geol. Surv. Can., Paper 68-1, Part A, pp. 43-52 (1968).

<sup>4</sup> Roddick, J. A.: Tintina Trench; J. Geol., vol. 75, pp. 23-33 (1967).

---

6.                   NORTHEAST CORNER MCBRIDE MAP-AREA,  
                      BRITISH COLUMBIA (93 H)

Project 680066

E. W. Mountjoy

This note provides additional information and modifies the geological map published by Campbell<sup>1</sup>. The field work was carried out during parts of the summers of 1967 and 1968 with additional air photograph analyses during 1969.

This small part of the McBride area is structurally equivalent to the Front Ranges and eastern Main Ranges of regions to the southeast. Only the extreme western part of the Foothills occurs in the northeast corner of the area and is underlain by Jurassic and Triassic strata. The Front Ranges consist of one thrust sheet, the Cecilia, which comprises Devonian, Ordovician and Cambrian strata. This thrust sheet is broken by two normal faults with west side down displacements of up to 2,500 feet.

The Wallbridge and Sir Alexander thrust sheets form the eastern Main Ranges. The Wallbridge thrust sheet consists of Ordovician to Lower Cambrian strata which dip about 30 degrees southwest. The Sir Alexander thrust sheet is folded into a 10-mile-wide asymmetric syncline with a more steeply dipping west limb. It forms the most prominent mountain range in the northeastern part of the area with a relief of more than 7,000 feet, exposing a complete Lower and Middle Cambrian succession north of Buchanan Creek.

These structures are bounded to the southwest by the Snake Indian thrust which divides the Main Ranges of this and adjoining areas into two distinct parts; a northeastern part with distinct thrust sheets, and a southwestern part comprising complexly folded Precambrian and Cambrian strata. The Snake Indian thrust is one of the longest (120 miles) and most important faults of the region. Northwestward this fault appears to continue to the Pine Pass area as the Back Range fault<sup>2</sup>. Surface exposures to the southeast in the adjoining Mount Robson west half map-area clearly indicate that this thrust is a low angle thrust fault with considerable displacement<sup>3</sup>.

The main differences on this map from the one published previously are:

1. Normal fault which extends across the Cecilia thrust sheet from Bastille Mountain south to Intersection Mountain.
2. Series of thrust faults of minor displacement which trend east-west between the Wallbridge and Cecilia thrusts.
3. Thrust fault of small displacement between Buchanan and Bastille Creeks.



- 
- <sup>1</sup> Campbell, R. B.: McBride (93 H) map-area, in Report of Activities, May to October, 1967; Geol. Surv. Can., Paper 68-1, Part A, pp. 14-19 (1968).
  - <sup>2</sup> Slind, O. L. and Perkins, G. D.: Lower Paleozoic and Proterozoic sediments of the Rocky Mountains between Jasper, Alberta and Pine River, British Columbia; Bull. Can. Petrol. Geol., vol. 14, pp. 442-468 (1967).
  - <sup>3</sup> Mountjoy, E. W.: Mount Robson (southeast) map-area; Geol. Surv. Can., Paper 61-31 (1962).
- 

## 7. UPPER TRIASSIC SEDIMENTS OF NORTHERN VANCOUVER ISLAND

Project 680038

J. E. Muller and R. A. Rahmani

### Introduction

Upper Triassic sediments were studied in some detail in the course of regional geological mapping of the Alert Bay and Cape Scott map-area (92 L, 102 I), northern Vancouver Island. These sediments form a significant, well-defined break between two thick piles of volcanic rocks, the Triassic Karmutsen and the Jurassic Bonanza. They are of great economic importance as they are host-rocks to many known skarn-type iron and copper deposits, and are adjacent to the newly discovered large low-grade copper-molybdenum deposit of Island Copper Mines near Port Hardy.

Earlier regional work on the formations had been done by Gunning<sup>1</sup>, who introduced the stratigraphic names "Quatsino" and "Bonanza", and by Hoadley<sup>2</sup>. Jeletzky<sup>3, 4, 5</sup> made detailed geological and stratigraphic surveys along the western coast-lines and made the first extensive collections of Triassic fossils. In 1968 and 1969 he consulted with the senior writer in the field and contributed some important collections to the Klaskino Section. The stratigraphic sections were measured by Rahmani and Muller is responsible for this discussion. E. T. Tozer<sup>6</sup> (and pers. comm.) identified all fossils, except those of the Iron River Section.

Three sections are described representing three belts of Upper Triassic sediments: a western belt, a central belt, and a northeastern belt (see Fig. 1). In a general way each belt is part of a major southwestward-tilted fault block where Quatsino Limestone and Bonanza Sediments outcrop between underlying Karmutsen lavas to the northeast and overlying Bonanza volcanic rocks to the southwest.

The central belt contains the thickest sedimentary section, more than 4,000 feet thick, and is areally the most continuous, though offset by several cross-faults. The northeastern and western belts contain sedimentary sections less than 2,000 feet thick and are interrupted by many faults and by

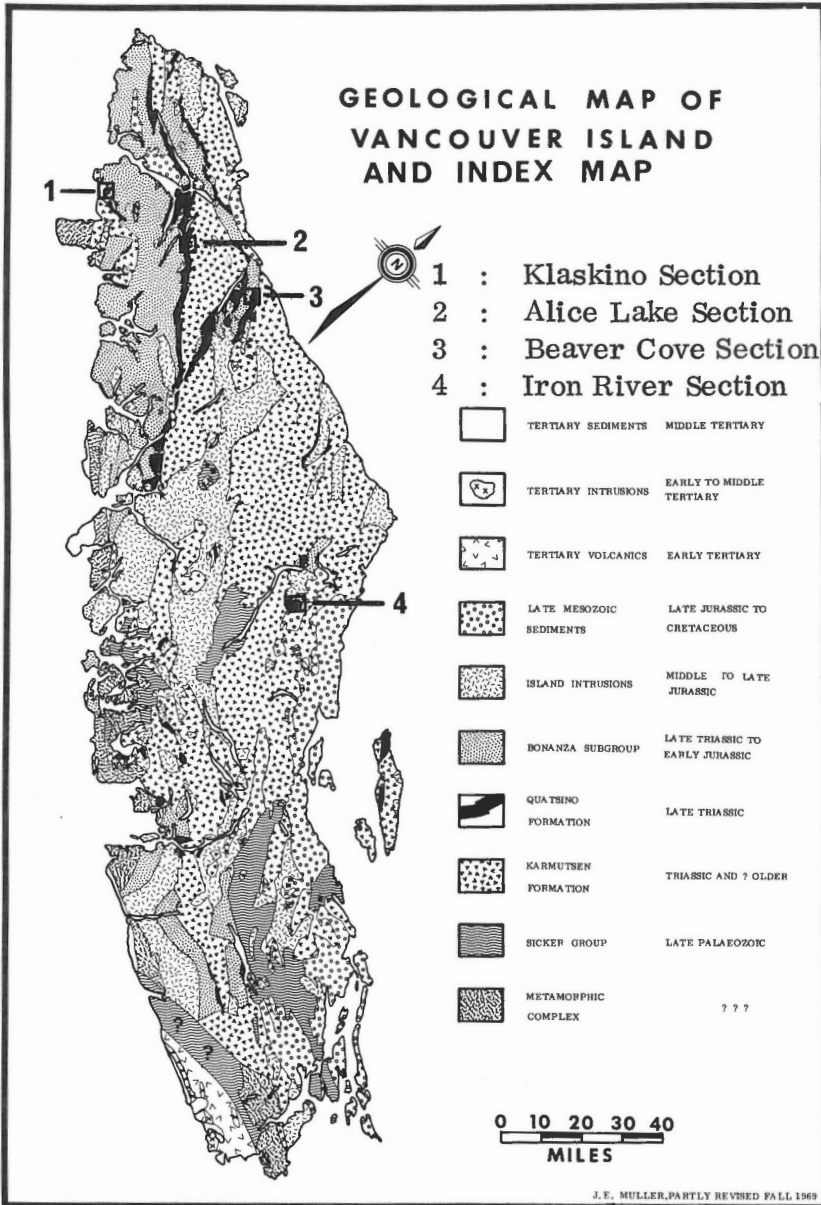

discordant and concordant basic and granitic intrusions. In these latter two belts many corrections in the stratigraphic sections are required to eliminate basic sills and cross-faults.

The sediments are less resistant to erosion than the underlying and overlying volcanic rocks and therefore generally underlie low-lying areas. As the lower slopes are densely forested sections can only be studied along the seashore, along some creeks, and in a few areas where logging has exposed the hillsides.

The western Klaskino Section was measured along the coast north of Klaskino Inlet, west of Red Stripe Mountain, between 50°18'50" and 50°19'30"N and at about 127°51'50"W.

The lower part of the Alice Lake Section was measured across a logged-off area east of the south-end of Alice Lake, between Malook Creek and Benson River. The middle part (medium-bedded limestone and Monotis-bearing beds) was partly exposed along logging-spur 64B of the MacMillan Bloedel Company's Tree Farm License Area 39, and the upper part was studied along Yootook Creek, in the Rayonnier Company's Tree Farm License Area 6. Topographic coordinates are 50°25'30"N, 127°20'05"W for the base and 50°22'55"N, 127°19'20"W for the top of the section.

The northeastern Beaver Cove Section was studied on a tributary of Tsulton River, just south of Beaver Cove, in an area logged by Crown Zellerbach Company in the Nimpkish Provincial Forest. Coordinates are 50°29'50"N, 126°53'20"W for the base and 50°28'35"N, 126°52'30"W for the top of the section.

The fourth section, shown for comparison, is from Iron River near Campbell River and was studied in detail by D. Carlisle<sup>7</sup> and coworkers<sup>8</sup>.

### Rock-stratigraphic Succession

The Upper Triassic succession has great lateral variations in lithology and thickness (see Fig. 2). Yet a general sequential pattern can be recognized in all sections. It exhibits a gradual increase upwards in clastic components at the expense of the carbonates.

The lower unit, resting conformably on Karmutsen Volcanics, consists of thick-bedded to massive, light-grey, fine- to microcrystalline, but locally coarse-crystalline, commonly stylolitic limestone. This unit is commonly devoid of fossils except for a few nondiagnostic corals and pelecypods. It is about 1,600 feet thick in the central section but only 80 feet in the western, 250 feet in the eastern section and 400 feet in the Iron River Section.

The Middle Unit consists of medium- to thin-bedded limestone (thickness 6 to 18 inches), interlaminated with black, calcareous siltstone (thickness 1/2 inch to 3 inches). The beds are commonly lenticular and outcrops have a 'ribbed' appearance. They contain locally abundant ammonites and pelecypods. Approximate thicknesses are 160 feet in the Klaskino Section, 990 feet in the Alice Lake Section, 680 feet in the Beaver Cove Section, and 110 feet in the Iron River Section.

The Upper Unit is fairly well exposed, although faulted, in the Klaskino Section, but only partly exposed in the Alice Lake Section where the lower part was studied along Spur 64B and in a steep gully, draining into Benson River about 1 mile farther southeast. The upper part was examined, again in incomplete exposures, along Yootook Creek. In the Beaver Cove Section the unit is only known from scattered road-exposures. The added difficulty of numerous basic sills intruding the sediments prevented recording a meaningful stratigraphic section.

The base of this unit is placed at the lowest beds containing grey-wacke, breccia, or predominant siltstone. This first influx of clastic material appears to be the only practical definition of the contact. Thus defined the unit consists in each section examined of several subunits, alternately containing predominant clastic and predominant carbonate material. However, these subunits cannot be mapped or correlated over any distance.

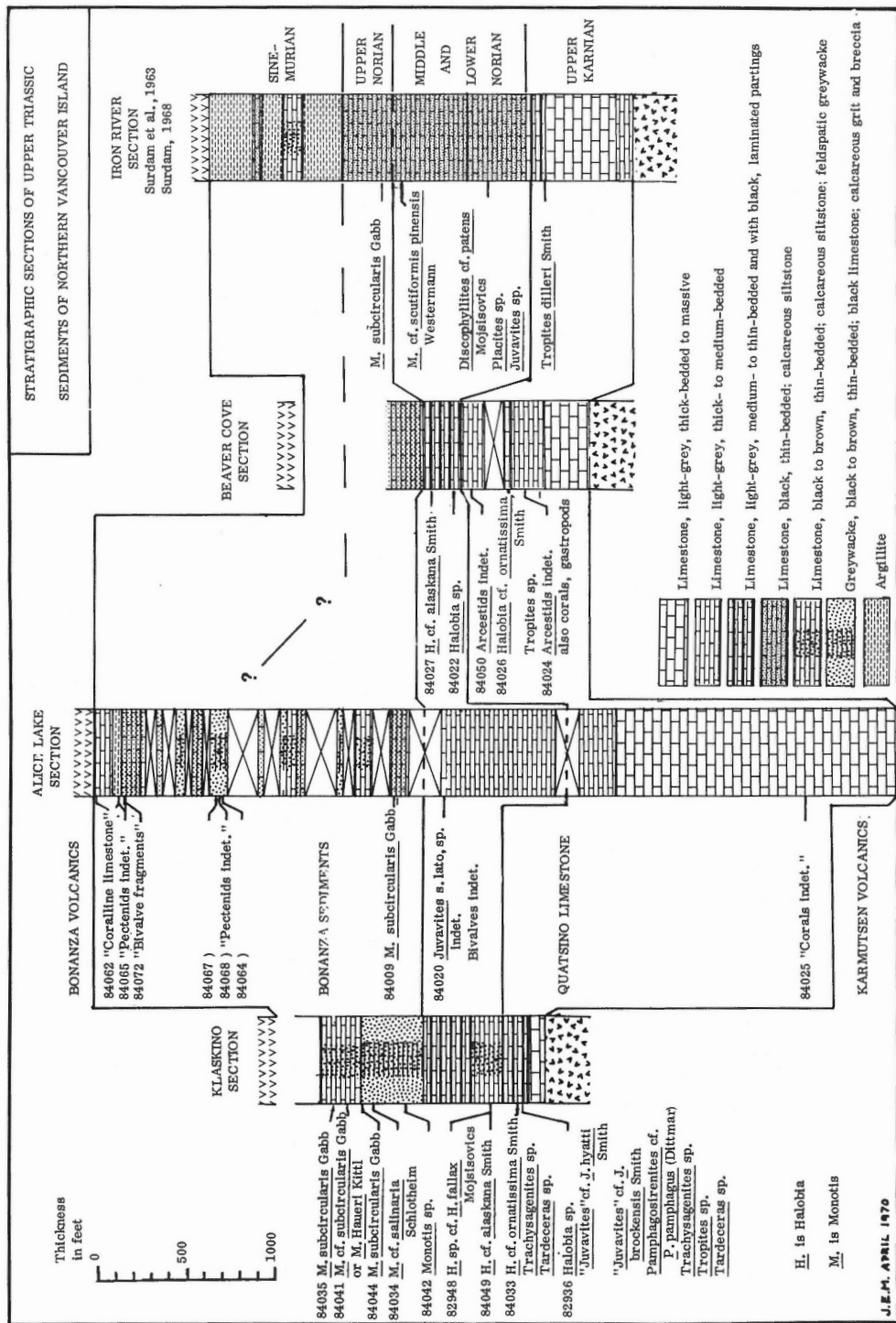

In the eastern section and the Iron River Section the unit consists entirely of thin-bedded black calcareous siltstone and silty limestone, containing in places abundant pelagic pelecypods like *Monotis*. In the central and western sections similar limestone is also present, but is interbedded with beds of calcareous, feldspathic greywacke and grit together with varying amounts of conglomerate and sedimentary breccia.

In the Klaskino Section the breccias contain fragments of limestone and greywacke and in some instances folded and crumpled beds of limestone, apparently formed by the slumping of newly formed limestone down the sea-bottom. Convolution and graded bedding in the greywacke also suggest the turbidite nature of these beds.

The top of the Alice Lake Section consists of a few hundred feet of silty and argillaceous limestone, capped by 20 feet of rather pure light-grey limestone with abundant colonial corals. They are overlain by Bonanza Volcanics. This contact is not exposed in the Klaskino Section and there the uppermost part is predominantly limestone and minor greywacke.

Thicknesses of the Upper Unit are 1,020 feet in the Klaskino Section, 2,050 feet in the Alice Lake Section, probably less than 500 feet above the Beaver Cove Section and 1,760 feet (including Jurassic beds) in the Iron River Section.

Sediments believed to be coeval with the Upper Unit are also exposed along several strips of coastline at the east-end of Quatsino Sound, namely between Smith Cove and Cultus Cove, on the south side of Drake Island, and east of Quatsino Village. Except for the outcrops on Drake Island these beds had earlier been studied by Jeletzky<sup>5</sup>. On the east side of Julian Cove he found fossiliferous limestone, overlain by a "waterlain breccia" containing fragments of limestone and volcanic rock in a calcareous and argillaceous greywacke-matrix. On the north shore of Quatsino Sound he estimated the thickness of this breccia-unit to be 2,100 feet. In both instances the breccia is overlain by dark-coloured to maroon amygdaloidal lavas and tuffs of the Bonanza Volcanic Division.

The writers examined the equivalent beds on the south shore of Drake Island, about half-way between the Julian Cove and Quatsino Village exposures. They found a total thickness of 3,650 feet of sediments, of which 1,470 feet were estimated in covered intervals. As there is probably repetition by faulting the true thickness of the section may be in the order of 2,000 feet. The section contains interbedded grey and black nodular to lenticular limestone and various kinds of sedimentary breccias with fragments of limestone and tuff. Sequences several hundred feet thick with predominant limestone alternate with several hundred feet of breccia. Toward the top, just below the Bonanza Volcanics, the close alternation of coralline limestone, arenaceous limestone, grit and breccia was especially noted.

#### Stratigraphic Names and Contacts

H. C. Gunning<sup>1</sup> introduced in a preliminary report on the Nimpkish Lake area three important names that have become well-established in Vancouver Island geology. The name Quatsino Formation, earlier used informally by Dolmage, was proposed for the "main limestone in the Nimpkish area". "Karmutsen Volcanics" was suggested for the underlying volcanics and the "assemblage of sedimentary and volcanic rocks above the Quatsino Formation" was termed "Bonanza Group". The Bonanza Group is actually a

"Sub-group", for together with Karmutsen and Quatsino it forms the Vancouver Group<sup>9</sup>. The Bonanza was divided by Jeletzky<sup>3</sup> into a Sedimentary Division and a Volcanic Division and the former was further divided in a "Thinly Bedded Member", an "Arenaceous Member", and a "Limestone Member". The latter divisions may be useful for detailed mapping in some west-coast areas but in the writers' opinion they cannot be carried over great distance or used for 1:250,000 reconnaissance mapping. Indeed in the west-coast sedimentary belt it is necessary for mapping purposes to include Quatsino Limestone with the Bonanza Sediments.

There is generally no problem in defining the contact between Karmutsen Volcanics and Quatsino Limestone, although in some cases there may be a transition zone, less than 100 feet thick, of interbedded volcanics and limestone.

The top of the Quatsino is difficult to establish. Without doubt the massive to thick-bedded limestone of the Lower Unit is Quatsino Limestone. The Middle Unit of medium- to thin-bedded limestone is included by the writer in the Quatsino and the Upper Unit of alternating carbonate and clastic sediments is equated with the Bonanza Sediments. It should be noted that limestone subunits of the Upper Unit are very similar to the beds of the Middle Unit. The Quatsino-Bonanza contact may thus be difficult to determine in areas of limited exposure. In general, the lowest beds containing clastic material may be considered to be the base of the Bonanza Sediments.

The contact between Bonanza Sediments and Bonanza Volcanics is commonly marked by amygdaloidal and porphyritic, in many instances, reddish coloured lava-flows. There may be a transition from sedimentary breccias with some volcanic material to true volcanic breccias.

#### Biostratigraphic Sequence

The faunal zonation of the Upper Triassic of Vancouver Island has been summarized by Tozer<sup>6</sup>. He recognized in collections by Jeletzky and others the Dilleri and Welleri Zones in the Upper Karnian, the Kerri Zone in the Lower Norian, the Columbianus Zone in the Middle Norian and Lower Suessi and Upper Suessi Zones in the Upper Norian. Later the Middle Norian Magnus Zone was identified in the Iron River Section<sup>10</sup>. Intervening faunal zones, established elsewhere in Western Canada, have not yet been discovered in the Vancouver Island collections.

The Tropites dilleri fauna, oldest Triassic fauna so far known on Vancouver Island, was not found in any of the sections studied. The fauna was discovered farther south in the western belt by Jeletzky, and again by Muller, on the largest Hisnit Island in Ououkinsh Inlet, in a limestone lens included in Karmutsen lavas. It was also found by Jeletzky on Union Island within Karmutsen volcanic rocks. The Dilleri Zone is also known from intervalcanic sediments west of the Iron River Section, on Texada Island, and on Quadra Island (see ref. 9 for further references). Only in the latter locality does it appear to be present in Quatsino Limestone, to which the local "Open Bay Formation" is correlated<sup>1</sup> (and Carlisle and Suzuki, pers. comm.). Thus the Dilleri Zone appears to represent the time of deposition of the upper part of the Karmutsen Volcanics and locally perhaps the lower part of the Quatsino Limestone.

No diagnostic fossils were found in the Lower Unit of massive limestone, but the Middle Unit of medium- to thin-bedded limestone yielded



Upper Karnian (Welleri Zone) faunas and in the Beaver Cove Section also Lower Norian fossils. The Lower Norian Kerri Zone is reported by Tozer<sup>6</sup> from more southeasterly locations in all three sedimentary belts. They were obtained from beds described by the collectors as Quatsino Limestone as well as Bonanza Sediments. Thus the sections and the other localities suggest that the Quatsino-Bonanza contact varies in age from Upper Karnian to Lower Norian.

The Upper Unit of the sections, equated with Bonanza Sediments, has yielded Lower and Upper Norian faunas. In regard to faunal zones only the Lower Suessi Zone was established in all sections by the presence of Monotis subcircularis Gabb (E. T. Tozer, pers. comm.: States that the taxonomy of the Upper Norian Monotis from Vancouver Island may require revision. Some identified as Monotis subcircularis may be referable to Monotis ochotica (Keyserling)). In the Kyuquot area the Thinly Bedded Member of Jeletzky, basal part of the Bonanza Sediments, has yielded the Middle Norian Columbianus Zone and the Lower Norian Kerri Zone.

The late Upper Norian Suessi Zone is suspected to be present in the upper limestone of the Alice Lake Section. The age of this subunit is not exactly known as the corals are undiagnostic. The writers tend to believe that it is the "Limestone Member" of Jeletzky<sup>3</sup>, later correlated with the Sutton Formation of Cowichan Lake area<sup>6</sup>. This limestone carries a diagnostic fauna of the Upper Suessi Zone, younger than the Lower Suessi Zone marked by Monotis subcircularis. However, for the present the possibility cannot be ruled out that the limestone of Yootook Creek, at the top of the Alice Lake Section, is Jurassic in age and correlative to Lower Jurassic sediments found below Bonanza Volcanics in the Iron River Section<sup>8</sup>.

Nevertheless, the presence of the Upper Suessi Zone in the central sedimentary belt is established by the occurrence of Parachlocceras sp., collected by Jeletzky from limestone at Julian Cove, mentioned previously in the discussion of the sediments of the Upper Unit. The sequence of Drake Island yielded only one somewhat diagnostic fossil collection. There limestone, about 500 feet below the top of the sedimentary section, yielded Pectenids indet. and Plicatula? sp. of "Late Norian?" age.

#### Paleogeographic Notes

The sections permit only some general remarks regarding paleogeography. The writers have earlier assumed<sup>11</sup> that the Upper Triassic sediments and overlying Bonanza Volcanics were deposited on the west-flank of a great, north-northwesterly elongated lava-plateau of Karmutsen basalt, now occupying the middle part of Vancouver Island (see Fig. 1). It appears that the sediments formed a large lenticular body, thickest in the central sedimentary belt, between Alice Lake and Quatsino Sound. Initially the volcanic pile was apparently submerged and only carbonate reefs were formed. But gradually in Norian time islands probably emerged and along their margins deposition of greywacke and breccia by turbid currents alternated with sedimentation of coralline and algal limestone. The region at the head of Quatsino Sound in the central sedimentary belt received the greatest quantity of debris whereas the western sedimentary belt, being farther removed from the land, apparently received less and finer grained clastic material. The eastern sedimentary belt, where only thin Upper Norian siltstones are known, may have been a shallow shelf, later emerging while the uppermost Norian greywackes and

breccias were deposited farther southwestward. In this regard it is also interesting to note that in the central belt, between Quatsino Sound and Alice Lake and near Jeune Landing, only a few hundred feet of Bonanza Sediments are present between Quatsino Limestone and Lower Cretaceous rocks<sup>12</sup>. This too may indicate early emergence of that area.

- 
- <sup>1</sup> Gunning, H. C.: Preliminary report on the Nimpkish Lake Quadrangle, Vancouver Island, B. C.; Geol. Surv. Can., Sum. Rept. 1931A, pp. 22-35 (1932).
  - <sup>2</sup> Hoadley, J. W.: Geology and mineral deposits of the Zeballos-Nimpkish area, Vancouver Island, British Columbia; Geol. Surv. Can., Mem. 272 (1953).
  - <sup>3</sup> Jeletzky, J. A.: Stratigraphy of the west coast of Vancouver Island between Kyuquot Sound and Esperanza Inlet, British Columbia; Geol. Surv. Can., Paper 50-37 (1950).
  - <sup>4</sup> Jeletzky, J. A.: Geological history of the west coast of Vancouver Island and Quatsino Sound; Bull. Geol. Soc. Am., vol. 65, No. 12 (2) (1954).
  - <sup>5</sup> Jeletzky, J. A.: Mesozoic and (?) Tertiary rocks of Quatsino Sound, Vancouver Island; unpubl. ms. (1968).
  - <sup>6</sup> Tozer, E. T.: A standard for Triassic time; Geol. Surv. Can., Bull. 156, (1967).
  - <sup>7</sup> Carlisle, D. and Suzuki, T.: Structure, stratigraphy and paleontology of an Upper Triassic section on the west coast of British Columbia; Can. J. Earth Sci., vol. 2, pp. 442-484 (1965).
  - <sup>8</sup> Surdam, R. C.: The stratigraphy and volcanic history of the Karmutsen Group, Vancouver Island, B. C.; Univ. of Wyoming, Contributions to geology, vol. 7, No. 1, pp. 15-26 (1968).
  - <sup>9</sup> Muller, J. E. and Carson, D. T. J.: Geology and mineral deposits of Alberni map-area, British Columbia (92 F); Geol. Surv. Can., Paper 68-50 (1969).
  - <sup>10</sup> Silberling, N. J. and Tozer, E. T.: Biostratigraphic classification of the marine Triassic in North America; Geol. Soc. Am., Special Paper 110 (1968).
  - <sup>11</sup> Muller, J. E.: Northern Vancouver Island, British Columbia (92 E, K, L, 102 I), in Report of Activities, Part A, April to October, 1969; Geol. Surv. Can., Paper 70-1, Part A, pp. 44-49 (1970).
  - <sup>12</sup> Jeletzky, J. A.: Mesozoic stratigraphy of northern and eastern parts of Vancouver Island, British Columbia (92 E, F, L, 102 I), in Report of Activities, Part A, April to October, 1969; Geol. Surv. Can., Paper 70-1, Part A, pp. 209-214 (1970).
-

8. AN OCCURRENCE OF ECLOGITE NEAR TINTINA TRENCH, YUKON

Project 670009

D. J. Tempelman-Kluit

*105 Kparts of*

A specimen of amphibole eclogite, collected by the writer in 1968, was examined in thin section and analyses were made of the rock and its constituent minerals. The locality, believed to be the first known occurrence of eclogite in the Canadian Cordillera, is on the southern flank of Rose Mountain in Tay River map-area ( $62^{\circ}17'30''N$ ,  $133^{\circ}27'W$ ). Exposure is poor, but the eclogite apparently forms a small lens, about 20 feet long and several feet thick, interfoliated with muscovitic quartzite of probable Hadrynian age. The quartzite is metamorphosed to greenschist facies and nearby Permian volcanic rocks are unmetamorphosed. Only one occurrence of eclogite is known in this region but 25 miles southeast of the eclogite occurrence a metamorphic quartzite carrying blue amphiboles is found adjacent to Vangorda Fault. The eclogite lens lies 500 feet north of Vangorda Fault, a steeply southwest dipping structure that can be traced for about 50 miles and which is part of the Tintina Fault System<sup>1</sup>. Vangorda Fault is intruded along much of its length by a 1,000-foot-thick serpentized peridotite. Movement on Vangorda Fault occurred between Late Permian and Middle Triassic time.

The eclogite is a fine-grained, apple-green rock made up largely of pyroxene and amphibole. It is studded with abundant small, euhedral, bright red garnets up to 5 millimetres across. The average mode from three counts of 500 points is:

Pyroxene	49.5
Amphibole	30.2
Garnet	13.6
Muscovite	3.0
Chlorite	3.0
Quartz	0.8

There is considerable range in the proportion of pyroxene, muscovite and chlorite in contrast to the garnet and amphibole.

The rock is a finely granular aggregate of fractured, anhedral equant pyroxene grains about 0.2 millimetre across. Subhedral prismatic megacrystals of amphibole 1 centimetre or more long, are scattered through the pyroxenes. Amphibole grain boundaries are irregular; some amphibole encloses small pyroxene grains. The garnet is isotropic and unzoned. It commonly includes tiny anhedral grains of an epidote group mineral, probably clinozoisite. Most garnet grains are rimmed by narrow irregular zones of muscovite in which the mica flakes are oriented parallel to the garnet crystal boundaries.

In this rock the garnet, pyroxene and amphibole are apparently primary. Chlorite is evidently secondary after pyroxene and some garnet and epidote after garnet.

Analyses of the eclogite, its garnet, pyroxene and amphibole are given in Table I.

Table I

	1	2	3	4	5	6	7
SiO <sub>2</sub>	51.9	38.5	38.6	38.9	38.2	54.0	52.2
TiO <sub>2</sub>	0.82	-	-	-	-	-	0.1
Al <sub>2</sub> O <sub>3</sub>	11.9	21.9	21.9	22.8	22.2	10.8	7.1
Fe <sub>2</sub> O <sub>3</sub>	1.9	26.5*	24.6*	24.4*	26.3*	5.0*	6.5*
FeO	7.7						
MnO	0.24	-	-	-	-	-	-
MgO	11.6	4.7	4.9	5.5	3.8	9.5	19.4
CaO	7.9	8.7	8.7	8.3	8.5	15.1	9.7
Na <sub>2</sub> O	2.0	-	-	-	-	6.0	3.5
K <sub>2</sub> O	0.6	-	-	-	-	-	-
H <sub>2</sub> O	3.6	-	-	-	-	-	-
	<u>100.16</u>	<u>100.3</u>	<u>98.7</u>	<u>99.9</u>	<u>99.0</u>	<u>100.4</u>	<u>98.5</u>

- 1 Eclogite, Yukon Territory; anal. S. Courville by rapid chemical analysis.
- 2 Garnet from above eclogite; anal. G. Plant, by microprobe.
- 3 Garnet from above eclogite; anal. G. Plant, by microprobe.
- 4 Garnet from above eclogite; anal. G. Plant, by microprobe.
- 5 Garnet from above eclogite; anal. G. Plant, by microprobe.
- 6 Pyroxene from above eclogite; anal. G. Plant, by microprobe.
- 7 Amphibole from above eclogite; anal. G. Plant, by microprobe.

Formulae of the four garnets calculated from the analyses on the basis of 24(O) are as follows:

	2	3	4	5
Si	5.99	6.05	6.00	6.02
Al	4.02	4.05	4.15	4.36
Fe	3.45	3.22	3.14	3.66
Mg	1.09	1.15	1.26	0.89
Ca	1.45	1.45	1.37	1.43
Almandine	57.6	55.3	54.4	61.2
Grossularite	24.2	24.9	23.5	23.9
Pyrope	18.2	19.8	21.6	14.9

The proportion of andradite cannot be determined from the microprobe analyses because these do not discriminate between ferrous and ferric iron and it is therefore assumed that all iron in the garnet is bivalent and that no andradite molecule is present. Because most of the iron in the eclogite (anal. 1) is in the ferrous state this assumption is probably valid.

The cell edge of two of the garnets is 11.612A and 11.609A; the specific gravity of part of one grain is 3.991 and the refractive index  $1.785 \pm .005$ . The physical properties agree well with the chemical data.

\* All iron reported as FeO.

The pyroxene in the Yukon eclogite is truly an omphacite; its chemical formula, recalculated from analysis 6 on the basis of 6(O) is given below; with its end member proportions.

Si	1.93	}	2.00		
Al	.07	}			
Al	.39	}	1.05	Jadeite	39%
Fe	.15			Acmite	3%
Mg	.51			Hedenbergite	12%
				Diopside	46%
Ca	.58	}	1.00		
Na	.42				

The recalculated formula of the amphibole in terms of 23(O) is:

Si	7.27	}	8.00
Al	0.73	}	
Al	0.43	}	5.23
Fe	0.76		
Mg	4.03		
Ti	0.01		
Ca	1.45	}	2.40
Na	0.95		

and the mineral is evidently close to edenite in composition.

Mineralogically and chemically the Yukon eclogite is comparable to eclogites found with glaucophane schists in California. The Yukon eclogite is also chemically similar to a tholeiitic olivine basalt although it carries a higher proportion of silica and a lower amount of magnesia and lime than the average tholeiitic olivine basalt of Nockolds<sup>2</sup>. Compared with other eclogite analyses the Yukon material is richer in silica than all, richer in magnesia than most and poorer in iron, lime and soda than many eclogites found elsewhere. The Yukon eclogite differs chemically from nearby extensive Permian basalt because it contains considerably more silica and magnesia and less alumina<sup>3</sup>.

Garnet in the Yukon eclogite contains less than 30 per cent pyrope and evidently belongs to the Group C eclogite type of Coleman *et al.*<sup>4</sup> The garnet compositions are close to the average of garnets from amphibolites. All the Yukon garnets fall close to, but outside of, the field of garnets from eclogites within glaucophane schists of Figure 9 of Coleman *et al.*<sup>4</sup>

Pyroxene in the Yukon eclogite is an omphacite typical of that found in Group C eclogites in that it contains a relatively high proportion of jadeite. The pyroxene also compares closely to omphacites from various European and California eclogites studied by Essene and Fyfe<sup>5</sup>. Amphibole of the Yukon eclogite contains more magnesia than that found in amphibole from similar rocks elsewhere.

The origin and significance of this eclogite occurrence is not clear because exposures do not allow close study of field relationships. The locality is very close to Vangorda Fault, a major transcurrent structure, and a genetic relationship to this fault seems probable. Whether the eclogite is exotic and brought up from the mantle along the fault, perhaps together with the alpine peridotite bodies also found along the fault or whether this peculiar

rock formed in place from Permian basalt by the application of high vapour pressure is not resolved. If the latter is the case the condition for eclogite formation must have been very local because, basalt also next to Vangorda Fault, is unmetamorphosed at nearby localities. Furthermore because a metamorphic quartzite carrying blue amphibole is found in the wall of Vangorda Fault at another locality in this region it seems possible that faulting allowed very local build-up of high vapour pressure near the fault long enough to allow transformation of some basalt to eclogite.

---

<sup>1</sup> Roddick, J. A.: Tintina Trench; *J. Geol.*, vol. 75, pp. 23-33 (1967).

<sup>2</sup> Nockolds, S. R.: Average chemical compositions of some igneous rocks; *Bull. Geol. Soc. Am.*, vol. 65, pp. 1007-1032 (1954).

<sup>3</sup> Tempelman-Kluit, D. J.: The geology and origin of the Faro, Vangorda and Swim concordant zinc-lead deposits in central Yukon; *Geol. Surv. Can.* (in preparation).

<sup>4</sup> Coleman, R. G., Lee, D. E., Beatty, L. B. and Brannock, W. W.: Eclogites and Eclogites: Their differences and similarities, *Bull. Geol. Soc. Am.*, vol. 76, pp. 483-508 (1965).

<sup>5</sup> Essene, E. J. and Fyfe, W. S.: Omphacite in Californian metamorphic rocks; *Centr. Mineral. and Petrol.*, vol. 15, pp. 1-23 (1967).

---

EXPLORATION GEOPHYSICS

9. ELECTRICAL AND MAGNETIC FIELD ABSORPTION METER

Project 620056

R. H. Ahrens

An electric and magnetic field absorption meter has been designed for contactless measurement of the electrical properties of rocks. The equipment consists of a sensor and an indicator unit as shown by block diagram in Figure 1. The principal of the meter is based on the response of a parallel resonant circuit to induced damping caused by alternating current losses in the rock sample when inserted in the solenoid or between the plates of the capacitor. The magnetic field absorption in the coil is a function of frequency, magnetic flux, conductivity and permeability while the electric field absorption in the capacitor is a function of frequency, imaginary permittivity and electric field strength.

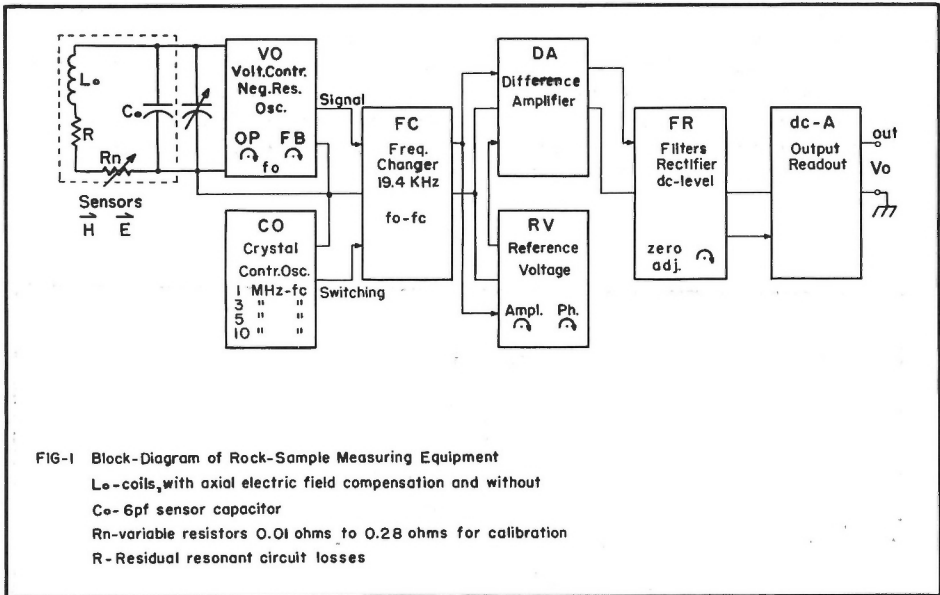

The sensor is basically a voltage controlled negative resistance oscillator, where the negative resistance is developed across the resonant circuit by positive feedback in Colpitts circuit of the common base transistor. The response of the voltage-controlled parallel resonant circuit is best described by a nonlinear differential equation in the form derived by Van der Pol<sup>1</sup>.

The oscillator is operated at a threshold of oscillation in Class 'A' so that the negative conductance of the active element cancels the damping and so narrows the bandwidth of the tuned parallel resonant circuit. This results in a very stable amplitude and frequency. The frequency stability over 4 hours of operation is 10 Hz per 1 MHz. The sensitivity of the resonant circuit in its response to induced damping increases rapidly with moderate decrease of the positive feedback in the vicinity of the threshold of oscillation.

The indicator unit is not restricted to resonant circuit type of sensors; it is applicable in measurements of incremental changes of signal levels. A novel circuit evolved from the requirement of a constant phase difference between a reference signal of a constant amplitude and the sensor signal which changes in amplitude and phase due to the power absorption by the sample.

A DC voltage at the output appears only with a signal voltage drop due to power absorption when a rock sample is placed in the coil or capacitor of the resonant circuit. Incremental change of the distributed capacitance of the coil due to the sample is nulled out by returning the parallel resonant circuit.

The indicator unit is operated at an intermediate frequency of 19.4 KHz. The nominal frequencies of the sensor unit are 1 MHz, 3 MHz, 5 MHz and 10 MHz. DC voltage at the output is linearly related to the intermediate frequency signal at the input. The minimum discernible difference signal at indicator input is 25 microvolts.

The method of evaluation of some electrical properties of rocks is based on power absorption in the magnetic field of a coil or in the electric field of a capacitor. Magnetic losses will in general include conductivity losses caused by migration of charge carriers in the form of eddy currents and hysteresis losses in magnetic fields of 0.03-0.07 oersted, which is the region of initial permeability. The separation of conductivity losses has yet to be solved. The electrical losses need not stem from a migration of charge carriers and are described by dielectric conductivity  $\sigma_d = \omega \epsilon''$ .

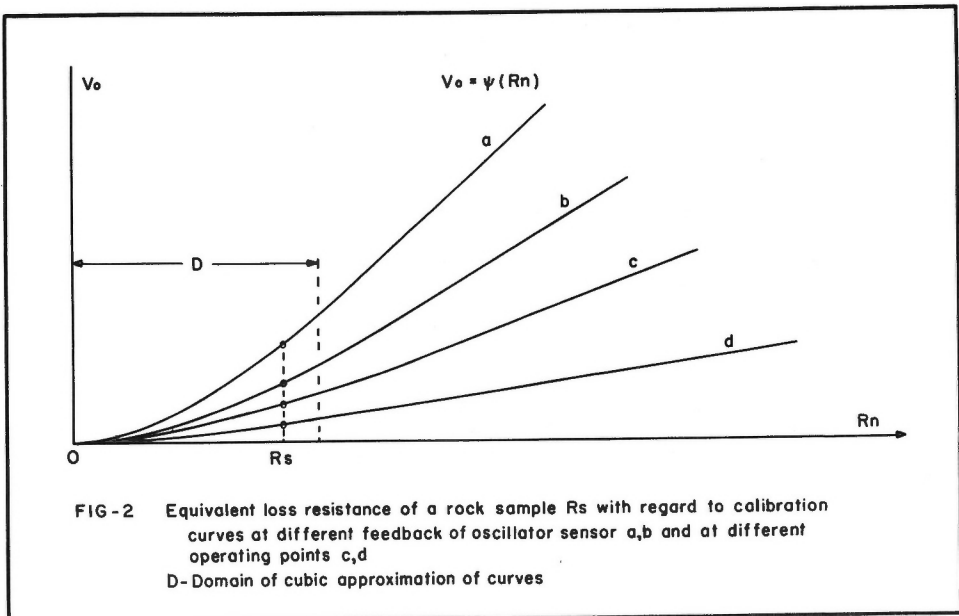



The equivalent loss resistance,  $R_s$ , of a sample is evaluated from the calibration curve which represents the DC output voltage as a function of series resistors,  $R_n$ , inserted in the resonant circuit and is variable in 16 steps from 0.01-0.28 ohms. The calibration curve is shown in Figure 2.

Samples of any material and form are characterized by their equivalent loss resistances in the sensor. Different materials of the same shape are compared according to the power losses in the resonant circuit. The absorbed power of standard samples, such as n-doped silicon, of known shape, is calculated from the magnetic field,  $H$ , in the coil. Measurements on lunar samples can also be taken with this absorption meter.

Mr. J. Frechette contributed to the realization of this project in the development of active circuits, structural design of the indicator unit and testing of the equipment.

---

<sup>1</sup> Van der Pol, B.: Non-linear theory of electric oscillations; Proc. IRE, vol. 20, p. 1051 (1934).

---

## 10. TIME-DOMAIN EM THEORY

Project 670564

A. Becker and A. V. Dyck

The object of this project is to develop a quantitative interpretation scheme for the calculation of apparent ground conductivity and conductivity-thickness parameters from INPUT data. To this end several theoretical and scale models have been examined.

A Calcomp computer program has been developed which can produce a set of plotted INPUT transients for a two-layer conducting earth. The program utilizes the digital simulation method of Becker<sup>1</sup> in conjunction with a USGS Fortran IV subroutine developed by Frischknecht<sup>2</sup> which gives the response, in the frequency domain, of a two-layer earth in the presence of an oscillating magnetic dipole. So far a set of two-layer transients has been produced using the primary waveform employed in the INPUT survey in the Ottawa area<sup>3</sup>.

In addition, the response of a sheet conductor of infinite extent was examined in order to further the understanding of the EM induction process. A modified version of Frischknecht's<sup>2</sup> program was used to compute the frequency-domain response of a thin sheet of thickness,  $s$ , to a dipolar inducing field of skin-depth,  $\delta$ . It was shown that when  $s/\delta < 0.7$ , the conducting sheet may be classified as 'thin'. If  $s/\delta$  becomes  $> 0.7$  there is a gradual transition into a region where the conductor responds as an infinite, conducting half-space. Preparation of a Geological Survey report on this problem is in progress.

The INPUT scale model is presently capable of operating in the full-transient mode. A number of full transients have already been obtained for various thin-sheet conductor configurations. In a further development which is nearing completion, the model is being extended to a fully-automated,

dynamic system with fifteen sequential channels. It will be able to simulate a fifteen-channel INPUT system in producing profiles over various conductivity models. The system will have digital output onto paper tape to facilitate model-to-computer interfacing.

- 
- <sup>1</sup> Becker, A.: Simulation of time-domain, airborne, electromagnetic system response; Geophysics, vol. 34, No. 5, pp. 739-752 (1969).
  - <sup>2</sup> Frischknecht, F.C.: Fields about an oscillating magnetic dipole over a two-layer earth, and application to ground and airborne electromagnetic surveys; Quaterly Colorado School of Mines, vol. 62, No. 1 (1967).
  - <sup>3</sup> Collett, L.S.: Airborne INPUT Surveys, Winkler Manitoba, Drumheller Alberta, Ottawa Ontario, in Report of Activities, Part A, April to October, 1968; Geol. Surv. Can., Paper 69-1, Pt. A, p.78 (1969).
- 

11. USE OF THE OMEGA RADIONAVIGATION SYSTEM  
FOR OCEAN AEROMAGNETIC SURVEYS

Project 650007

Margaret E. Bower

Accurate navigation is one of the major problems of aeromagnetic surveys over the ocean. When the aircraft is several hundred miles from land and at a low altitude, dead reckoning is often the only means of obtaining a position. In 1969 the Omega V. L. F. navigation system was used for the first time by the National Aeronautical Establishment's North Star aircraft during a survey of the Labrador sea<sup>1</sup>.

The Omega network consists of four stations located in Norway, Trinidad, New York and Hawaii, transmitting on frequencies of 10.2 and 13.6 kHz. A hyperbolic pattern of phase differences is produced having lane widths of 8 to 12 miles. The installation on the aircraft converts the signals into two or more lines-of-position, these are plotted (with a skywave correction) on an Omega plotting chart, and their point of intersection is the aircraft's position. Theoretical accuracy is 1 mile during the day, 2 miles at night.

A more accurate and convenient method now under development will convert the Omega readings directly to latitude and longitude using a computer installed on the aircraft. Furthermore, Omega plotting charts are not available for both frequencies, and the existing charts do not show all of the six possible lane patterns. A Fortran program, prepared by the United States Navy<sup>2</sup> and modified by the Observatories Branch, does either Omega to geographic or geographic to Omega conversion using a very accurate, non-iterative method developed by Sodano<sup>3</sup>. This program was revised to simulate real-time operation, debugged on the IBM-360, then rewritten for the Interdata computer used on the aircraft.

In its simplest form, the program is initialized at the start of the trip by specifying two transmitter pairs, the frequency to be used, and the latitude and longitude of the point of departure. The program receives readings from the Omega set every 10 seconds, keeps track of the lane numbers and computes the geographic position in degrees, minutes and seconds. These may be recorded on the data tape and displayed for the navigator. A more versatile version of the program, now in preparation, will permit the use of both frequencies and compute the best position from as many as four transmitter pairs. The accuracy of the system depends of course on the quality of the incoming signal, and it is hoped that the use of both frequencies will enhance this.

- 
- <sup>1</sup> Hood, P.J. and Bower, M.E.: Labrador Sea: Low Level Aeromagnetic Investigations in 1969, in Report of Activities, Part A, April to October, 1969; Geol. Surv. Can., Paper 70-1, Pt. A (1970).
  - <sup>2</sup> United States Naval Oceanographic Office, Informal Report No. N-3-64: Omega to geographic conversion and geographic to Omega conversion.
  - <sup>3</sup> Sodano, E.M.: General non-iterative solution of the inverse and direct geodetic problems; Bull. Géodesique No. 75 (1965).
- 

12. A TEST STRIP FOR CALIBRATION OF  
AIRBORNE GAMMA-RAY SPECTROMETERS

Projects 670052 and 670050

B.W. Charbonneau and A.G. Darnley

One of the prime aims of airborne gamma-ray spectrometry is to relate in-flight measurement of radioactivity to ground-level concentration of potassium, uranium and thorium. In order to undertake this an area of known radio-element abundance is required, which can be test-flown under typical survey conditions. The specifications for such a strip are as follows:

1. homogeneous surface composition;
2. minimum of 1 mile long by 1/4 mile wide;
3. flat surface, with no obstacles to low flying along major axis;
4. accessible for ground measurements;
5. well marked to facilitate recognition from the air.

During the spring of 1969 experimental flights had been conducted across the area immediately north of Ottawa between the Ottawa and Gatineau Rivers. Several potential test strips were identified for ground examination, but the only one to meet the above requirements is shown on Figure 1. It is close to Breckenridge, Quebec. It has a railway as a centre line and cross roads for starting and finishing points. A ground survey has been undertaken over a length of 1 mile, by 1/3 mile wide. There is evidence to suggest that its length can be extended northwestward for some distance along the railway

31 G

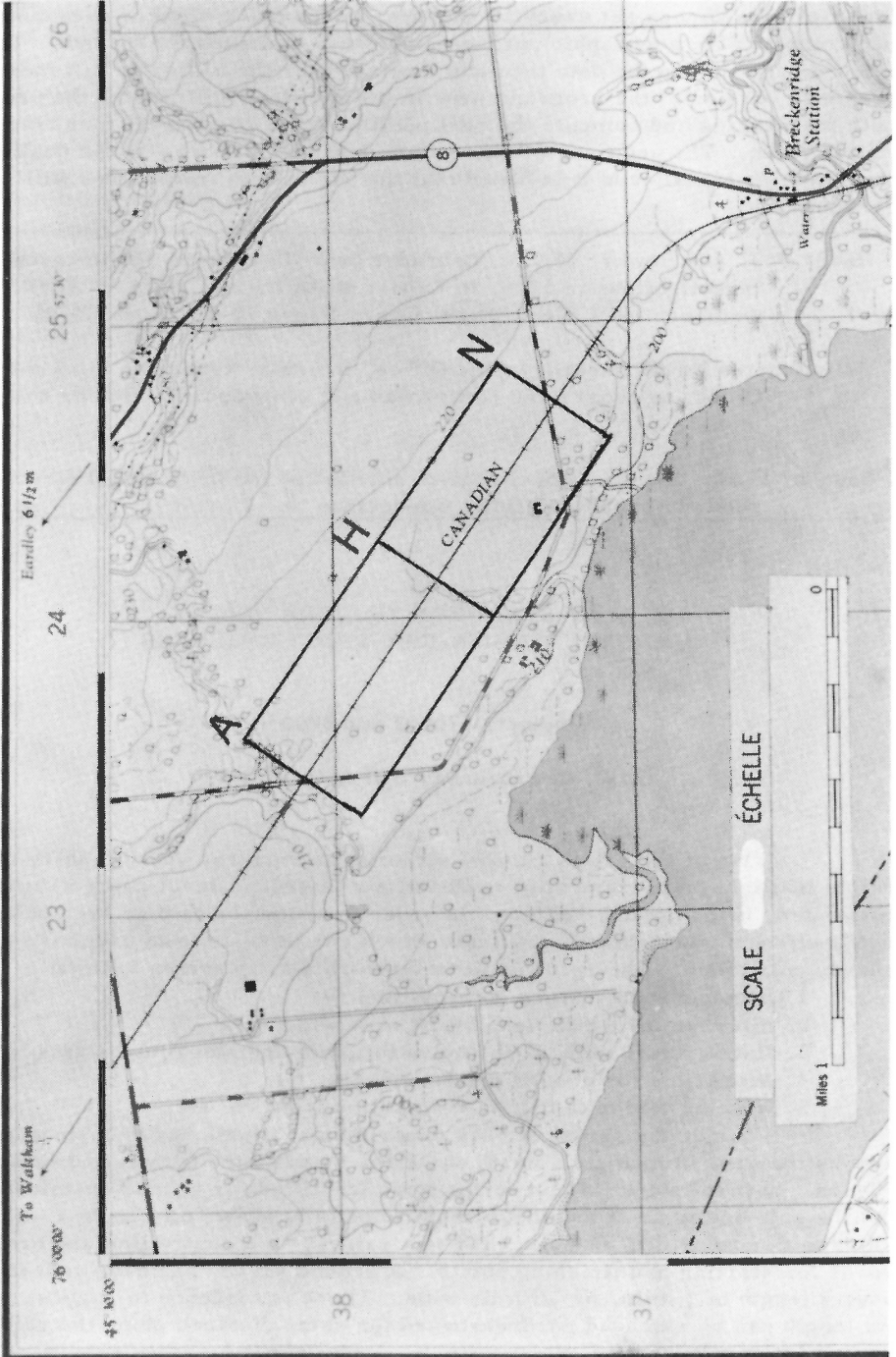

over a surface of the same composition. The proximity of the Ottawa River, which is 1 mile wide, is very convenient for the purpose of obtaining airborne background measurements.

The geology of the strip has been referred to in an earlier publication<sup>1</sup>. Measurements have been made on the ground using an Atomic Energy of Canada Ltd. CPD-153B field spectrometer. The observations made on July 2, 9 and 15, 1969 are shown in Figure 2. The mean values uncorrected and corrected are as follows:

<u>Field Spectrometer</u>	<u>K</u>	<u>U</u>	<u>Th</u>
Observed c. p. m.	460	67	66
Background value	35	16	8
Corrected for background	425	51	58
Corrected for Compton scattering ( $\alpha = 0.7$ ; $\beta = 0.8$ ; $\gamma = 1.2$ )	365	10	58

On the basis of control measurements on the calibration slabs at Uplands airport, Ottawa, these count rates correspond to 1.8 per cent K, 0.5 ppm eU and 8.0 ppm eTh.

The test strip was flown on July 20 with a helicopter-mounted gamma-ray spectrometer [3 (5 x 5) in NaI (Tl) crystals] as previously described<sup>2</sup>. This was flown at 250 feet terrain clearance. The mean values, uncorrected and corrected are as follows:

<u>Helicopter Spectrometer</u>	<u>K</u>	<u>U</u>	<u>Th</u>
Observed c. p. m.	53.0	8.0	10.4
Background value	8.8	2.5	1.2
Corrected for background	44.2	5.5	9.2
Corrected for Compton scattering ( $\alpha = 0.4$ ; $\beta = 0.6$ ; $\gamma = 1.1$ )	36.7	1.8	9.2

It is of interest to compare the correlation between ground and air count rates obtained at Breckenridge with those previously reported from work undertaken by the Geological Survey of Canada in the Bancroft area during 1968<sup>2</sup>. This is done in Figure 3. The Breckenridge result is added to the points previously obtained, and very good agreement is apparent. This is very encouraging with regard to the precision of field gamma-ray spectrometry insofar as the other measurements were obtained a year previously, in a different area, although the instrumentation was the same.

On July 29, 1969 the test strip was flown with the GSC Skyvan spectrometer system in reconnaissance mode [6 (9 x 4) in NaI (Tl) crystals] at several different heights. There had been some rain the previous night. Results at 400 and 500 feet terrain clearance are given below. Note that the counting interval is 5 seconds. The observed count rate thus approximates to that obtained with 12 (9 x 4) in crystals in a 2.5 second counting interval, which is the mapping mode for the system.

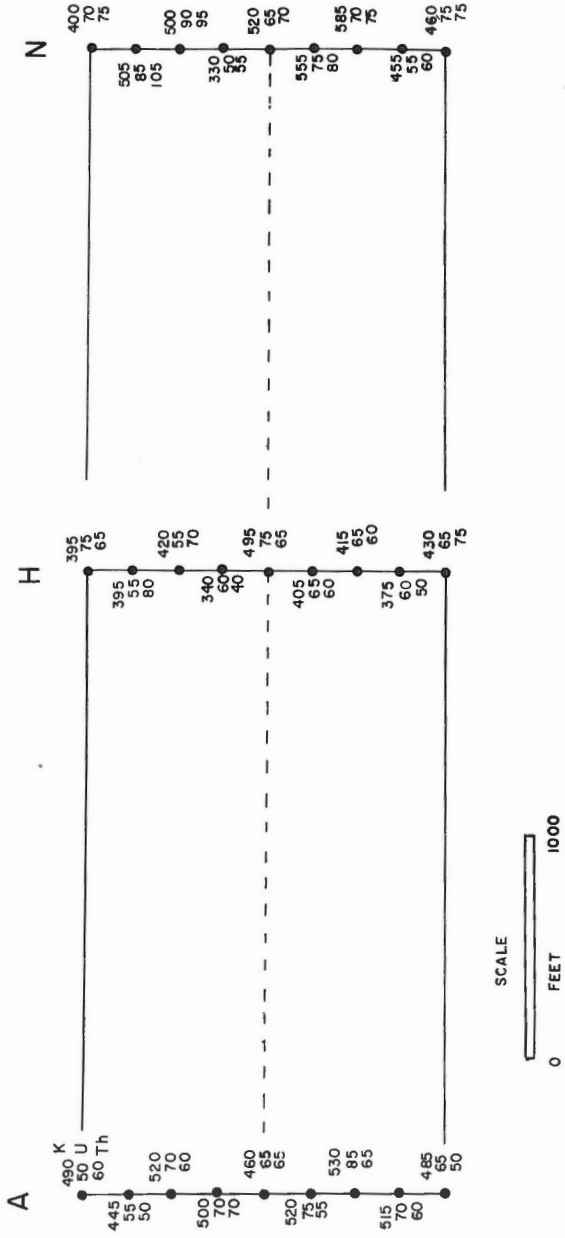

Figure 2. Breckenridge Test Strip. Ground gamma-ray spectrometer readings.



<u>Skyvan Spectrometer at 400 feet</u>	<u>K</u>	<u>U</u>	<u>Th</u>
Observed c. p. 5 seconds	465	99	127
Background	110	55	42
Corrected for background	355	44	85
Corrected for Compton scattering ( $\alpha = 0.4$ ; $\beta = 0.4$ ; $\gamma = 0.6$ )	310	13	85

<u>Skyvan Spectrometer at 500 feet</u>	<u>K</u>	<u>U</u>	<u>Th</u>
Observed c. p. 5 seconds	368	89	106
Background	110	55	42
Corrected for background	258	34	64
Corrected for Compton scattering	224	10	64

Based on the above data, the following correlation is obtained between air-borne count rate and ground concentration for the Skyvan system. The count rates are counts per unit time interval (5 sec. for 6 crystal system).

	400 feet	500 feet
Counts/per cent K	172	124
Counts/ppm eU	26	20
Counts/ppm eTh	10.6	8

Whilst these values are reasonably accurate, they are regarded as only provisional pending repetition on several different occasions with six and twelve detector crystals in operation and with known measured ground moisture content.

---

<sup>1</sup> Charbonneau, R. W. and Darnley, A. G.: Gamma-ray support, Bancroft, Ontario and Gatineau area, Quebec, in Report of Activities, Part A, April to October, 1969; Geol. Surv. Can., Paper 70-1, Pt. A, pp. 69-71 (1970).

<sup>2</sup> Darnley, A. G.: Airborne gamma-ray spectrometry; Can. Inst. Mining Met. Bull., vol. 73, pp. 20-29 (1970).

---

13. RADIOACTIVE PRECIPITATION AND ITS SIGNIFICANCE  
TO HIGH-SENSITIVITY GAMMA-RAY SPECTROMETER SURVEYS

Project 670052

B. W. Charbonneau and A. G. Darnley

318  
During the summer of 1969 the Geological Survey of Canada undertook further gamma-ray spectrometry experiments based at Bancroft, Ontario. A helicopter-mounted installation (described in ref. 1) was based on the airstrip at Bancroft together with a mobile laboratory used for storing and maintaining equipment. On the late afternoon of July 28th there was a heavy



thunder and rain storm during which 1 inch of rain fell over a 20 minute period. This followed several days of hot summer weather.

Atmospheric background recorded on the morning of July 27th over Lake Baptiste was 2.5 counts per second in the Bi-214 channel. On the morning of July 28th it was 5.5 counts per second showing that atmospheric build-up of the decay products of radon was taking place. During the afternoon of July 28th the helicopter spectrometer was being checked on the ground for stability and the count rates were being observed continuously on a strip chart recorder. This recorder was running throughout the period of the rain storm. Immediately after the storm at about 5:45 the crew inspected the equipment and noted that it was off-scale on the Bi-214 channel. An instrument malfunction was suspected but as an independent check on radiation levels a small portable field ratemeter was switched on and the general level of radioactivity was confirmed as being about twice normal. Two portable field gamma-ray spectrometers in the mobile laboratory were then brought into operation and their readings monitored. Figure 1 shows a plot of the count rate variation with time in the Bi-214 channel of the three spectrometers and the small ratemeter. Table 1 shows a plot of count rates in the potassium and Tl-208 channels. The fact that the Tl-208 channel count rate remained constant throughout the duration of the observations shows that the cosmic background was not responsible for the increased activity observed in the Bi-214 channel. The increase in the potassium count rate is attributable solely to increased Compton scattering proportional to the increase in the Bi-214 count rate. Because the Bi-214 record was off-scale just after the rain storm, the Bi-214 values shown on Figure 1 (dashed line part) have, where necessary, been calculated from the following formula:  $U = K/\gamma$  where U is the increase in Bi-214 count rate, K is the increase in the potassium count rate and  $\gamma$  is the Compton scattering factor between these energy levels for the helicopter spectrometer ( $\gamma = 1.1$ ). From the plot in Figure 1 it will be seen that the half-life of the radiation is approximately 25 minutes. This compares with the decay time of 20 minutes for Bi-214. At the peak the uncorrected Bi-214 count rate was six times normal; it had completely returned to normal after 7 hours. A probable explanation for the observations is suggested by a paper by Wilkening<sup>1</sup>. The decay products of radon in the atmosphere, Po-218, Pb-214, and Bi-214, are initially present as positively charged particles which may or may not be electrically neutralized by attaching themselves to dust particles in the atmosphere. A thunderstorm acts both as a collector of positively charged ions and as a 'scrubber' of dust particles, as is demonstrated by the improved visibility following the passage of a thunderstorm. Measurements by Wilkening show that the radon content of the atmosphere remains fairly constant throughout the storm period but a ten-fold reduction in daughter ion concentration may occur. Although some of the ions may be lodged in the stratosphere many of them, together with the dust, will probably be subsequently returned to earth in the heavy rain associated with such a storm. Part of the composite half-life of the daughter products between parent Rn-222 and Bi-214 will have expired during collection and circulation of the particles within the thunderstorm. Thus the observed half-life of the decay products on the ground is only slightly longer than the half-life of Bi-214 which suggests that this is the principal constituent of the precipitation.

The important lesson to be drawn from these results is that gamma-ray spectrometry survey activities should not be carried out during, or within several hours of, heavy thunderstorms unless the background is carefully

RADIOACTIVE SHOWER OBSERVED AT BANCROFT, ONTARIO JULY 28th, 1969

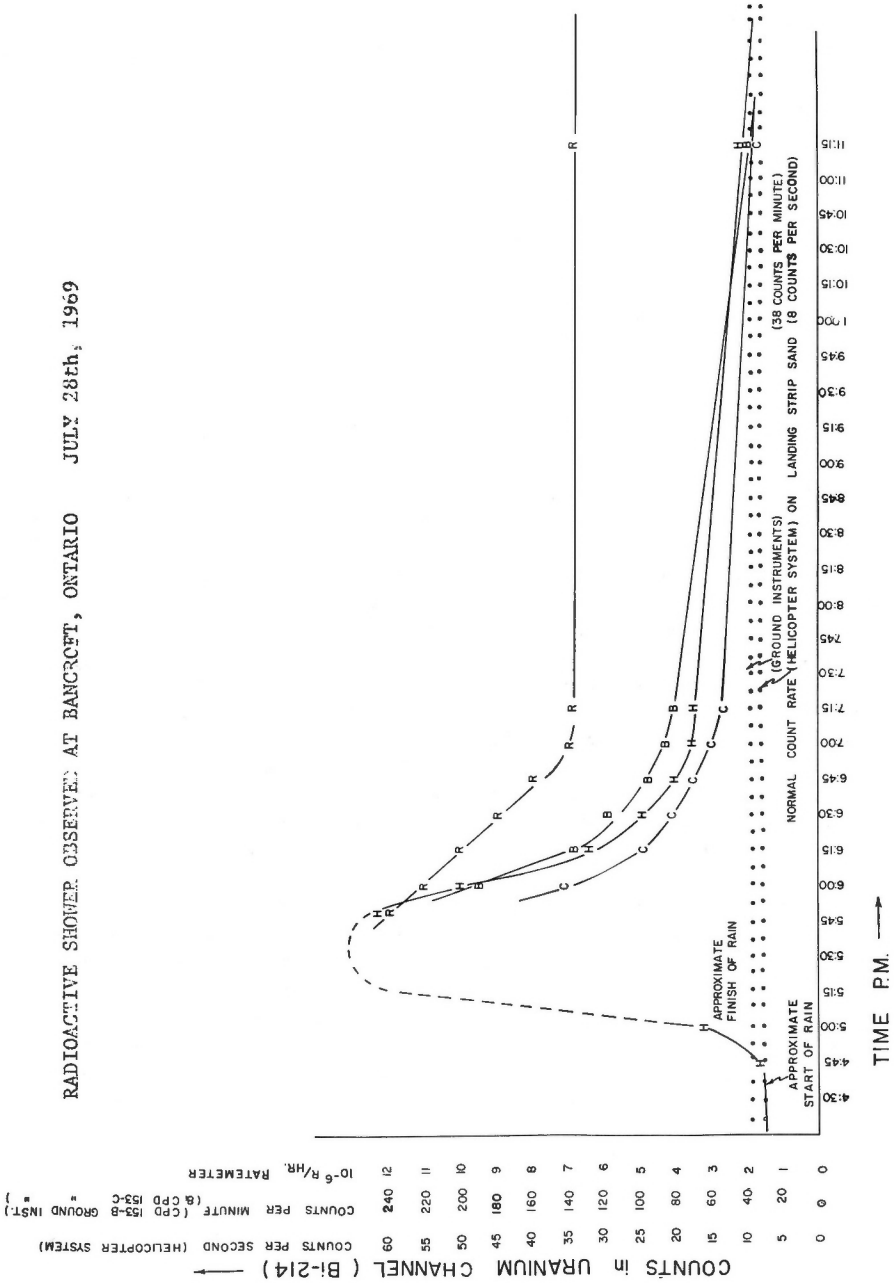

Table 1

HELICOPTER  
SPECTROMETER UNCORRECTED

counts per second

<u>Time P. M.</u>	<u>K</u>	<u>U</u>	<u>Th</u>
430	94	8	7
445	94	8	7
500	104	16	8
545	130	63	9
600	120	50	8
615	102	32	8
630	96	25	8
645	90	20	8
700	90	16	8
715	86	16	8
1115	80	10	8

Stripping factors:  $\alpha = .4$ ;  $\beta = .6$ ;  $\gamma = 1.1$

PORTABLE RATEMETER

$\mu$ R/hr

-  
-  
-  
12  
11  
10  
9  
8  
7  
7  
7

CPD 153-B UNCORRECTED

counts per minute

<u>Time P. M.</u>	<u>K</u>	<u>U</u>	<u>Th</u>
600	544	190	34
615	500	136	34
630	492	120	34
645	466	96	36
700	440	84	26
715	436	84	28
1115	348	38	28

Stripping factors:  $\alpha = .7$ ;  $\beta = .8$ ;  $\gamma = 1.2$

CPD 153-C UNCORRECTED

counts per minute

<u>K</u>	<u>U</u>	<u>Th</u>
542	140	28
492	98	26
474	84	28
446	76	26
426	60	24
392	52	24
402	38	22

Based on the CPD 153-B readings and the following calibration values (200 cpm = 1%, 20 cmp = 1 ppmeU, 7 cpm = 1 ppmeTh) the bulk composition of the landing strip sand is:

	<u>K</u>	<u>U</u>	<u>Th</u>
Uncorrected observation	348	38	28
Normal background	35	16	8
Corrected for background	313	22	20
Corrected for Compton	287	8	20

(K = 1.4%; eu = 0.4 ppm; eTh = 3.0 ppm)

Table 1 (cont'd)

If the readings taken at 6 p. m. were used to calculate the composition of the landing strip sand and NO ALLOWANCE was made for the abnormal background the following values would be obtained:

	<u>K</u>	<u>U</u>	<u>Th</u>
Uncorrected observation	544	190	34
Normal background	<u>35</u>	<u>16</u>	<u>8</u>
Corrected for background	509	174	26
Corrected for Compton	289	156	26

(K = 1.4%; eU = 7.8 ppm; eTh = 3.7; within experimental limit)  
This gives an apparent uranium content 20x true value.

checked to establish that it is not abnormal. In the case of airborne surveys the tracks of heavy thunderstorms should be avoided until anomalous surface activity has had a chance to decay. If the Bi-214 precipitated on the ground in this example had been interpreted as being due to uranium in the ground then the correct concentration would have been exaggerated more than twenty-fold. Because even a two- or three-fold increase in apparent surface uranium content might be interpreted as being highly significant from a mineral exploration point of view the importance of avoiding this type of precipitation cannot be overemphasized.

---

<sup>1</sup> Darnley, A. G.: Airborne gamma-ray spectrometry; Bull. Can. Inst. Mining Met., vol. 73, pp. 20-29 (1970).

<sup>2</sup> Wilkening, M. H.: Radon-daughter ions in the atmosphere, in the Natural Radiation Environment, pp. 359-368, ed. J. A. S. Adams, W. M. Lowder, Univ. Chicago Press (1964).

---

14. A VIBRATING-SAMPLE MAGNETOMETER

Project 670069

K. W. Christie, R. M. Schaeffer and E. J. Schwarz

A vibrating-sample magnetometer can provide a continuous measure of the intensity and direction of remanent or induced magnetization of a sample, while the latter is being heated and kept in a field free space or exposed to a high magnetic field. These records yield relevant information on the nature of the magnetization carried by rocks pertaining to the reliability of their paleomagnetism, their anisotropy, and their coercivity. The functions of this instrument are intermediate between those of an astatic magnetometer which is used to perform discrete measurements of natural remanent magnetization of rocks in a field free space and at room temperature, and

those of a thermomagnetic balance which gives a continuous record of the intensity of magnetization of a sample as a function of its temperature or the applied field.

The principle of a vibrating-sample magnetometer is the detection of the time varying part of the magnetic field due to a vibrating dipole. The variations of the field produced by a magnetic dipole oscillating between two extreme positions are equivalent to those of an alternating quadrupole. This quadrupole is formed by two dipoles located at the extreme positions of the sample motion and reversing their moments with the frequency of the oscillation. A few possibilities exist in selecting the direction of motion of the sample in respect to the external magnetic field and in arranging the detection coils. A sample vibrating in a direction perpendicular to the applied field has been chosen as the most adapted alternative in this particular case. The different components of the magnetic moment can be determined separately according to the location, the shape and the connection of the detection coils.

This instrument is designed to measure standard sized cylindrical samples (1 1/4 inch in diameter, 1 1/8 inch in length) at a frequency of about 40 hertz. The sample is driven by means of an electromagnetic vibration system.

15. AEROMAGNETIC PROFILE FROM CAPE CARGENHOLM,  
BAFFIN ISLAND TO RED HEAD, WEST GREENLAND

Project 650007

374

Peter Hood and Margaret E. Bower

Since 1962 the Geological Survey of Canada and the National Aeronautical Establishment have co-operated in joint low-level aeromagnetic surveys of the continental shelves and deep-ocean basins adjacent to Canada. Figure 1 shows one of the profiles which have been obtained across Baffin Bay. The survey equipment used was a digitally-recording rubidium-vapour magnetometer which was installed in the NAE's North Star aircraft. Astro, Doppler and Loran A navigational aids were used to position the track of the aircraft which was flown at a nominal height of 1,000 feet across Baffin Bay. The inset at the top of Figure 1 locates the position of the aircraft track from Cape Cargenholm on the northeast coast of Baffin Island to Red Head in the Melville Bay area of West Greenland, a distance of about 382 statute miles.

Below the inset is the resultant total intensity profile which has had the regional magnetic gradient removed. A number of short-wavelength anomalies appear at either end of the total intensity profile and in order to bring these out in a more definitive way, a digital high-frequency bandpass filter, which did not attenuate frequencies between 0.1 and 1.0 nautical miles (0.185 to 1.85 km), was applied to the data. The resultant filtered total-field profile is shown between the bathymetric profile at the bottom of the figure and the total-field profile. The reader should note that the vertical scales of the filtered and total-intensity profiles differ by a factor of 32. It can be seen that at the coast of Baffin Island (Point A), the high frequency activity on the filtered

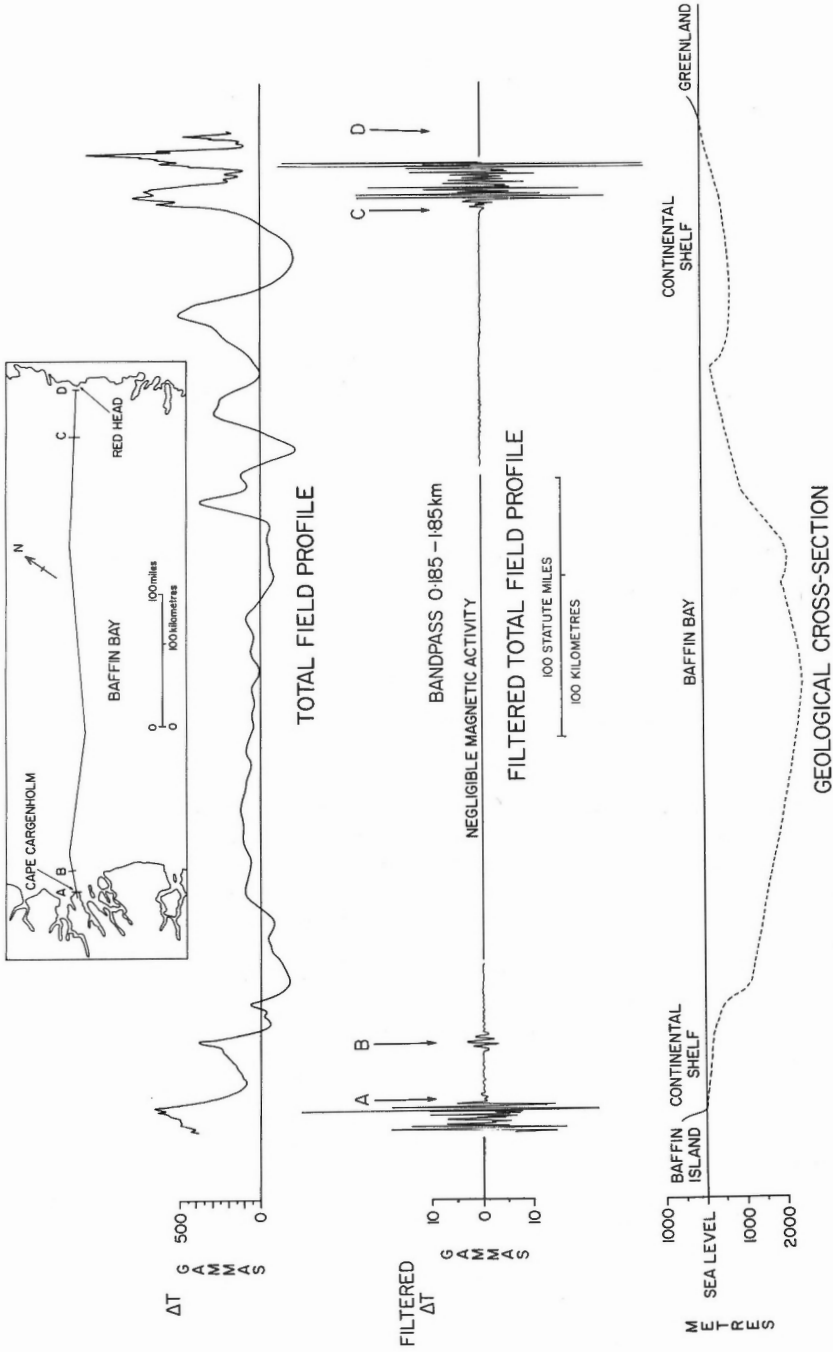

AEROMAGNETIC PROFILE DATA AND GEOLOGICAL CROSS-SECTION ACROSS BAFFIN BAY

profile stops abruptly and that there is another short length of high frequency anomalies about 16 miles from the coast, the centre of which has been labelled point B on the filtered profile. The slope of the continental shelf appears to steepen at this point. This fine structure is caused by the proximity of crystalline basement rocks of Precambrian age which occur on Baffin Island and as these basement rocks deepen offshore the high frequency activity consequently diminishes. Because the amplitude of the high frequency anomalies abruptly diminishes at the coast of Baffin Island, it is reasonable to conclude that a considerable sedimentary section exists on the Baffin Shelf. Moreover the presence of the high-frequency anomalies on the outer part of the shelf would also strongly suggest that a basement ridge runs along the outer part of the shelf which is probably similar to that found along the eastern seaboard of North America. Depth determinations carried out on the profile presented and on the adjacent profiles indicate that the thicknesses of sedimentary rock exceed 10,000 feet in this area of the Baffin Shelf.

On the Greenland side, the crystalline basement rocks appear from the filtered trace to extend for about 35 statute miles offshore from the coast (Point D) before abruptly deepening at Point C. From this and adjacent profiles the distinct U-shaped anomaly immediately west of Point C would appear to be due to a deep sediment-filled graben whose width is approximately 35 miles. The sequence of anomalies farther west are produced by causative bodies whose tops are buried more than 20,000 feet below the ocean surface. Sedimentary cover in the central deep-ocean part of Baffin Bay exceeds 20,000 feet over large areas which is the reason why the anomalies in that part of the profile have such a low amplitude.

16.

## ELECTRICAL ROCK PROPERTIES

Project 630049

T. J. Katsube

Not much is known about the conduction mechanism in rocks, though the principles of electrical methods in exploration geophysics are mainly based on the difference of these properties that exist in rocks. It can be said that an obstacle stands in the way of the development of new methods or new ideas in this field, because of this lack of knowledge. The fields that are affected by this obstacle are not only the existing methods such as IP, EM, and resistivity sounding, but perhaps also the application and development of RF and microwave techniques to exploration geophysics.

Much work on the electrical rock properties has been carried out, up to the present day, by many scientists all over the world. And this work is more or less compiled in the recent publications by Keller and Frischknecht<sup>1</sup>, Ward and Fraser<sup>2</sup>, Parkhomenko<sup>3</sup>, and Fuller and Ward<sup>4</sup>. But these results are not satisfactory as far as forming a basic concept of the electrical phenomena in rocks.

Through many preliminary experiments, which have been carried out during the last year in this laboratory, over the frequency range of 0.01 Hz

to 30 MHz, an attempt has been made to understand many problems that have not been clarified in the study of electrical rock properties. Based on these results, plans have been formed to organize work in the direction which is considered to produce effective results. Some of the important problems are stated below.

### 1. Contact Effect

When measuring dry rocks, the contact impedance (the contact between the electrodes and rock samples) appears to be usually very large, and it can affect the measurement of the rock samples to a large extent, unless certain considerations are taken. It has become possible to evaluate the contact effect quantitatively, and therefore an approach is being made to make these considerations, which are for example, selection of appropriate sample impedance (selection of sample thickness), a method to decrease contact impedance, and selection of the adequate frequency range for measurement. But under the present circumstances it seems to be very difficult to measure the true electrical properties of dry rocks correctly, below frequencies of 100 Hz.

### 2. Measurement Circuit

The electrical current that flows through the rocks can be classified into two types; ohmic current (related to resistivity of sample) which is in phase with the voltage or current source, and displacement current which is 90 degrees out of phase (related to the dielectric constant). In dry rocks the displacement current exceeds the ohmic current usually by 10 times or more. Therefore it is generally difficult to make accurate measurements of the ohmic resistance, due to instrumental, sample holder and circuit conditions. However measurement systems with full control over these problems have been set up, and reliable data can be produced over the frequency range of 0.01 Hz to 30 MHz, within certain limits of the displacement and ohmic current ratio.

### 3. Separation of Grain Boundary Effects

From reference to work done on electrical properties of solid electrolytes<sup>5</sup> and iron<sup>6</sup>, and from certain indications in measurements carried out at the Geological Survey, it seems certain that the grain boundaries largely affect the resistivity of dry rocks. The method to separate this effect from the resistivities of the rock forming minerals has not yet been completed. But it is expected that the separation of these effects will succeed, and this is considered to be a very important subject.

### 4. Effect of Moisture

The dielectric constant of rocks is considered to vary with moisture, according to work carried out in the past<sup>3, 4</sup>.

Measurements carried out in this laboratory give indications that the dielectric constant does not change with moisture, or even if it does it does not seem to be large enough, in order to be significant. The following explanations may be adequate for the results carried out in the past.



When dry rocks become moist, the conductivity increases, therefore either (a), this effect has not been sufficiently taken into consideration in the interpretation procedure, or (b) there is an electrochemical phenomena that produces results that appear as if the dielectric constant changes. However it is expected that this problem will be clarified in the near future.

The 'grain boundary' problem concerns the electrical properties of rocks not only on earth but on the moon and perhaps other planets, whereas the 'moisture effect' is a problem limited to earth, at present.

When the above-mentioned problems are clarified and the standardization of measuring and data-interpretation systems are completed and classified, an effective research program should start on the electrical properties of all kinds of rocks. The program should consist of the following studies:

1. Classification of rocks and minerals by their electrical properties.
2. Effect of rock texture for sedimentary, igneous and metamorphic rocks.
3. Effect of mineral composition.
4. Effect of sulphide dissemination and all kinds of mineral alterations.
5. Further study on the electrode polarization of minerals.

---

<sup>1</sup> Keller, G.D. and Frisknecht, F.C.: Electrical methods in geophysical prospecting, pp. 1-55, Pergamon Press (1966).

<sup>2</sup> Ward, S.H. and Fraser, D.C.: Conduction of electricity in rocks, in Mining Geophysics (ed. by Soc. Ec. Geophys.), pp. 197-224 (1967).

<sup>3</sup> Parkhomenko, E.I.: Electrical properties of rocks, Plenum Press (1967).

<sup>4</sup> Fuller, B.D. and Ward, S.H.: Linear system description of the electrical parameters of rocks; IEEE Transactions on Geoscience Electronics, vol. GE-8, No. 1, pp. 7-18 (1970).

<sup>5</sup> Bauerle, J.E.: Study of solid electrolyte polarization by a complex admittance method; J. Phys. Chem. Solids, vol. 30, pp. 2657-2670 (1969).

<sup>6</sup> Brannovic, M. and Hawarth, C.W.: Grain-boundary contribution to the electrical resistivity of iron; J. Applied Physics, vol. 40, No. 9 (Aug.), pp. 3459-3464 (1969).

---

17. SPECTRA FROM A HIGH RESOLUTION GE(LI) DETECTOR

Project 670053

L. Ostrihansky

1. The Measurement of Natural Radioactivity

The measurement of natural radioactivity with a Ge(Li) detector permits the quantitative estimation of both uranium and its decay products. Figure 1 shows the natural spectrum of a sample of uranium ore containing 4 per cent uranium in the form of pitchblende. This spectrum is over the range from 30 to 150 KeV. U-238 and its decay products Th-234, U-234, Th-230, Ra-228, Pb-214, Pb-210, and Bi-210 have gamma emission or X-ray conversion lines in this low energy range. The 63 KeV line of Th-234 is convenient for measurement being strong and not close to other lines. U-235 and its decay products Th-231 and Th-227 have gamma lines in this low energy region.

Measurements on such a spectrum have been used for the determination of radioactive equilibrium between the isotopes Th-234 and Pb-210. These isotopes are convenient for determination of gross sample equilibrium because Th-234 is the second and Pb-210 is one of the last members of the uranium decay series. These measurements are being used for investigation of the state of equilibrium of ground control samples collected in the field in connection with airborne gamma-ray spectrometer surveys.

2. X-ray Fluorescence Analysis using Radioisotope Sources

The Ge(Li) detector is being used to analyze X-ray fluorescence in the 30-120 KeV range. The source used has been Co-57 with an energy of 122 KeV which is suitable for excitation of K-lines of heavy elements from uranium to tungsten in the periodic system. By using a lead support for this radioisotope it has been possible to extend the useful excitation range. The lead acts as a target for the Co-57 and the lead K X-rays excite elements below tungsten in the periodic table. Thus one primary source enables measurements to be obtained for all elements down to barium.

Figure 2 shows the X-ray fluorescence spectrum of a sample of uranium ore from a Denison mine, Elliot Lake, Ontario. As is shown in this figure an interesting association of heavy elements, notably rare earths is present together with uranium and thorium. It is estimated that using this technique, concentration of elements can be measured down to 50 ppm using a counting time of 2 hours.

Work has commenced on the measurement of lighter elements by radioisotope X-ray fluorescence using a Pu-238 source.



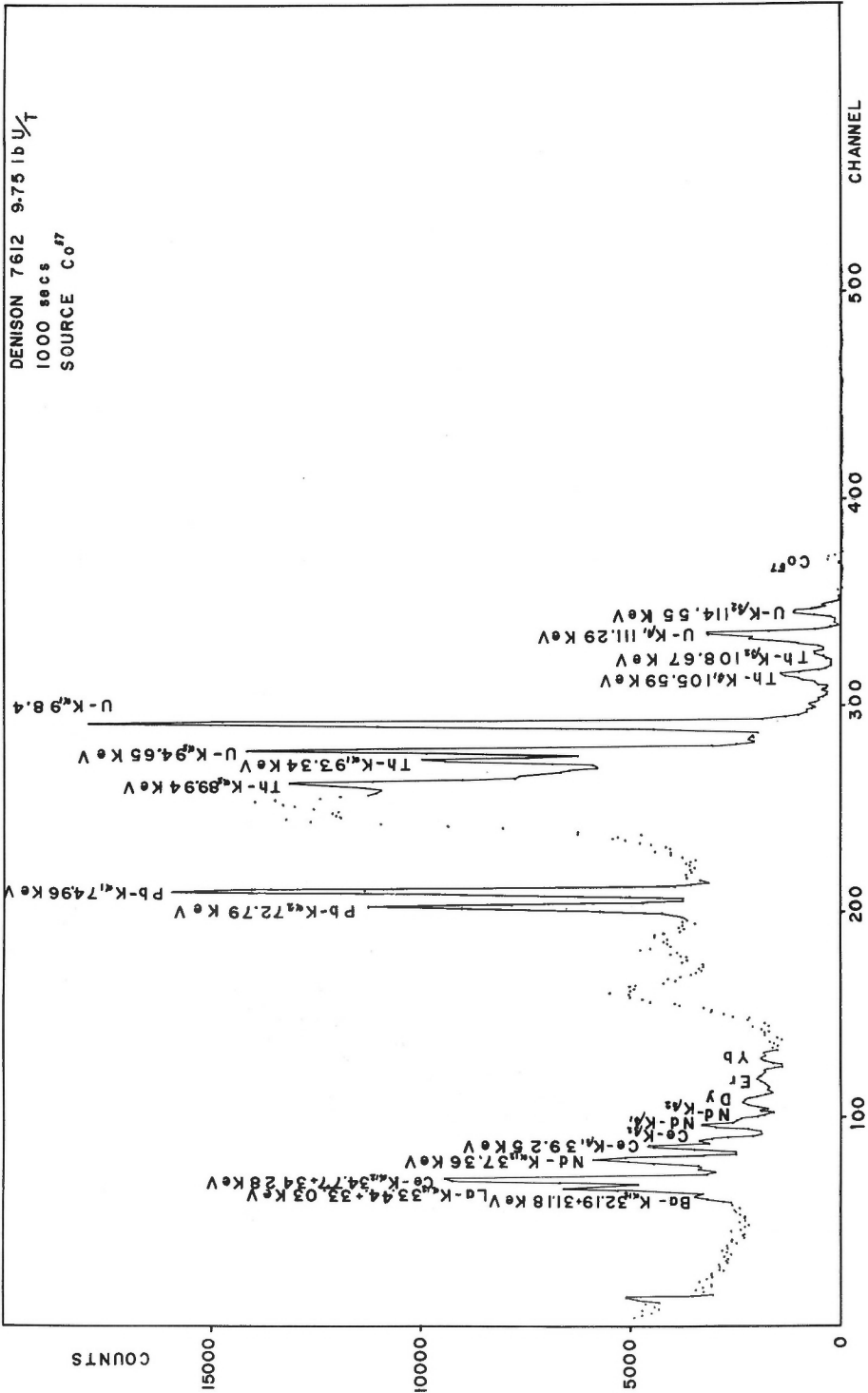

Figure 2. The X-ray fluorescence spectrum.

18. A VARIABLE LOW-FREQUENCY POWER SIGNAL GENERATOR

Project 670040

W. J. Scott and C. Gauvreau

For AC resistivity studies in the field, a low-frequency portable signal generator has been designed and constructed to provide a nearly-sinusoidal output at a power output of approximately 300 watts. The apparatus consists of three units: a motor generator, unit 1 and unit 2 (Fig. 1).

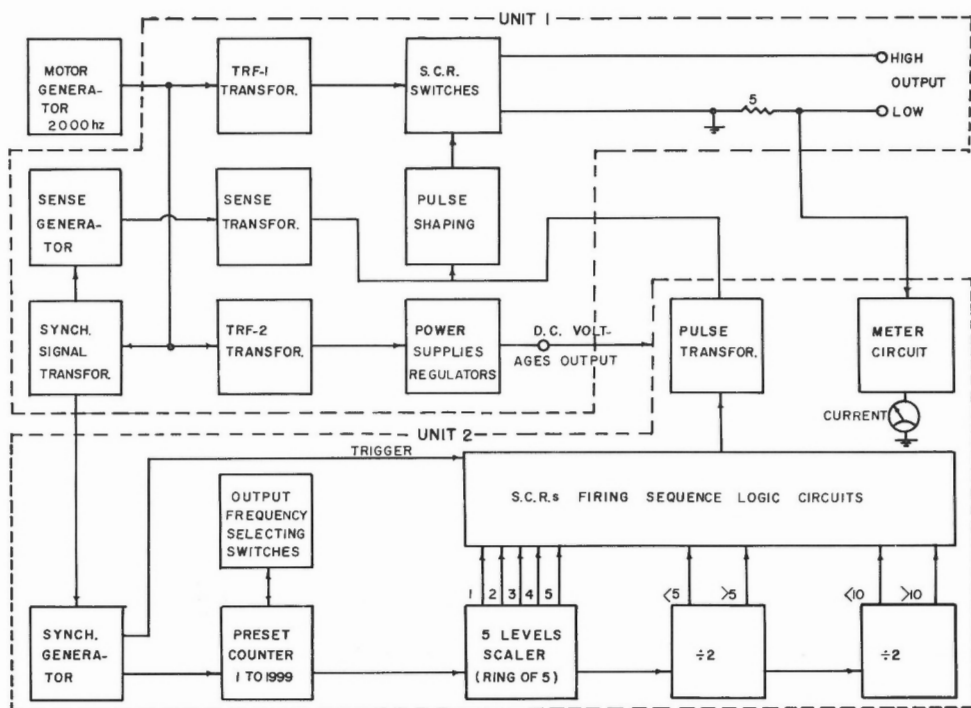

Figure 1. Block diagram of power signal generator.

Power is supplied from a gasoline motor-driven alternator at a frequency of 2000 Hz. The power conversion efficiency at 0.9 amperes is 79 per cent when the output waveform is unfiltered or 63 per cent after filtering.

The output of the generator is applied to the TRF-1 transformer in unit 1. The secondary taps of the transformer are connected to silicon controlled rectifiers (S.C.R.) switches. The secondary of the transformer has 11 taps with the centre tap being a common point. The voltage present between the centre tap and the taps on the upper portion of the secondary are always 180 degrees out of phase with the voltages present between the centre tap and the taps on the lower portion of the secondary.

The S.C.R.'s are switched on one at a time, at a rate of 4 KHz by pulses coming from unit 2. The sequence in which the S.C.R.'s are switched on is such that it produces a synthesized sine-wave at the output. The output frequency is determined by the number of times the corresponding sets of S.C.R.'s, connected to the taps with the same voltage amplitude, are fired consecutively. Therefore, the output voltage will remain at the same voltage level longer for the lower frequencies than at higher frequencies. The frequency is adjustable from 200 Hz to approximately 0.01 Hz following the relationship

$$f = \frac{200}{nm}, \text{ where } m = 1 \text{ or } 10 \text{ and } n = 1, 2, 3 \dots 1999.$$

The purpose of unit 2 is to supply firing pulses in the proper sequence to the S.C.R.'s. The synchronized generator, synchronized with the motor generator emits trigger pulses to the S.C.R.'s firing sequence logic circuits and to the present counter. The present counter counts the number of pulses from the synchronized generator and emits a pulse and resets to zero after a certain number of pulses have been counted. The number of pulses counted is determined by the setting of the output frequency selecting switches. The ring of 5 counter determines which of the five levels of voltage from the secondary of the transformer will be applied to the output of the system. Output 5 from the ring of 5 counter is applied to a divided by 2 stage. The <5 and >5 outputs determines if the output voltage should be rising or falling. The >5 output of this stage is applied to another  $\div 2$  stage. The <10 and >10 outputs determine if the output voltage should be positive or negative.

The trigger output from the synchronized generator, the 5 outputs from the ring of 5, and the 4 outputs from the two  $\div 2$  stages are all applied to the S.C.R.'s firing sequence logic circuits. These logic circuits decide, depending on the states of the input lines, which of the S.C.R.'s will fire. The firing pulses are applied to the proper S.C.R. through pulse transformers and pulse shaping networks.

Extensive use was made of semiconductor components and integrated circuits in the building of this equipment.

Phase and amplitude measurements using this power signal generator were made in the field over nine sulphide deposits of varying character, shape and depth of burial. Although definite induced polarization effects were observed, no phase shifts were recorded that could not be explained by electromagnetic coupling between the transmitter and receiver dipoles.

LUNAR STUDIES

19. LUNAR CRUST INVESTIGATION

Project 670561

J.A. Maxwell

Two crystalline igneous rocks and a sample of the <1 millimetre portion of the lunar regolith returned by the Apollo XI manned lunar landing mission were analyzed for thirty major, minor and trace constituents<sup>1</sup>. Conventional rock analysis methods were supplemented by special procedures for fluorine and chlorine, total carbon and sulphur, and carbon dioxide. A new composite scheme, utilizing a lithium fluoborate method for dissolution of the samples and measurement of eleven constituents by atomic absorption spectroscopy and colorimetry, was also applied to determine the applicability of the procedure, which requires only a relatively small amount of sample, to lunar material. Trace element determinations, with the exception of lithium and zinc, were done by optical emission spectroscopy.

The compositions of the three lunar samples superficially resemble that of terrestrial basalts but are characterized by a very high titanium content (7-12 per cent TiO<sub>2</sub>), the absence of Fe (III), very low alkalis and an almost complete absence of volatile constituents, notably water. A small sulphide phase is present in each, and the fines contain a minor metallic phase as well. Chromium is an important minor constituent of the three samples, but zirconium, yttrium and scandium are also noticeably enriched in them, as is barium relative to the low potassium content. The nickel content of the rocks is about 5 ppm but is about 200 ppm in the fines, where it is thought to have a meteoritic origin.

The collaboration of S. Abbey, W.H. Champ and the staff of the Spectrographic Laboratory, J.G. Sen Gupta and J.L. Bouvier, in the study of these samples, is gratefully acknowledged.

---

<sup>1</sup> Maxwell, J.A., Abbey, S. and Champ, W.H.: Chemical composition of lunar material; Science, vol. 167, No. 3918, January 30, pp. 530-531 (1970).

---

METAMORPHIC PETROLOGY

20. PETROCHEMICAL STUDY OF GRENVILLE GRANULITES

Project 690034

E.W. Reinhardt and G.B. Skippen

This project began in September 1969 with the object of improving the understanding of conditions obtained during high-grade regional metamorphism of granulites from selected localities of the western Grenville Province. Although granulites are widespread throughout the Canadian Shield, their genesis, in all but a few areas, is either obscure or speculative. On the other hand, granulite metamorphism could have important implications directly related to processes such as orogeny and ore formation.

To date, sampling has been carried out in the Gananoque<sup>1</sup> and Westport<sup>2</sup> map-areas of southeastern Ontario as part of a program designed to evaluate granulite metamorphism along the Frontenac Axis where metamorphic boundaries have been proposed by Wynne-Edwards<sup>3</sup> and de Waard<sup>4</sup>. This region is one of the few places in the Grenville Province where granulites have been mapped in consistent detail and initiation of the project in such an accessible area allows for inexpensive re-examination of field relationships where petrochemical data suggests further clarification. The immediate concerns of the investigation are the stability of the association biotite-orthopyroxene and factors governing the equilibrium partitioning of Fe<sup>+2</sup> and Mg between these minerals.

There is a certain amount of confusion in the use of the term 'granulite' but for purposes of this presentation, a loose definition consistent with that employed in Canadian reconnaissance geology is adequate. Following this, granulites may be regarded as high-grade metamorphic rocks that characteristically contain pyroxene and that exhibit distinctive olive-green or brown colours of weathering. Metamorphic charnockites can be thought of as quartzofeldspathic granulites of overall granitic aspect and which contain orthopyroxene but lack compositional layering or banding. A further distinction can be made between charnockites proper and enderbites<sup>5</sup> on the basis of the dominant feldspar phase; the former have a higher proportion of K-feldspar relative to plagioclase, whereas the latter have plagioclase as the major feldspar.

Current opinions vary as to what conditions of temperature (T), load pressure (P<sub>l</sub>), water pressure (P<sub>w</sub>), and oxygen pressure (P<sub>o</sub>) are registered by common granulite mineral assemblages. Experience has shown that for the lower grades of metamorphism, facies and subfacies can be rationalized by comparing natural to idealized mineral associations, the latter being related by simple mineral reactions to higher and lower grade associations. This has led to a realistic progressive scale of metamorphism concurrent with field observations and which accounts for the regularity of assemblages from one region to another as well as permitting comparison of metamorphic intensity over relatively short distances. This general approach,



however, has been less rewarding in dealing with regional metamorphism above middle amphibolite facies, although several detailed classification schemes have been advanced. The main disagreement arises in the interpretation of physical conditions where assemblages contain both hydrous and anhydrous minerals. This difficulty becomes further apparent in field applications especially where rocks typical of more than one subfacies occur over distances in the order of a hundred feet. There is also a tendency in most classifications to relate grade, at least in part, to properties of individual minerals, for example: colour of hornblende or biotite, and aluminum content of orthopyroxene. Undoubtedly, mineral compositions will bear some relationship to  $T$ ,  $P_1$ ,  $P_w$ , and  $P_o$ , but the manner of dependence is largely unknown. In view of the above mentioned conflict, further facies subdivision of granulites from the Grenville Province should be reserved until:

1. the stability ranges of key granulite associations are known more precisely;
2. the influence of variables  $T$ ,  $P_1$ ,  $P_w$ , and  $P_o$  on the partitioning of major elements among typomorphic minerals has been determined experimentally.

In order to maintain some uniformity in discussing interrelationships of high-grade associations from the Grenville Province, it is advisable to impose some compositional restrictions on rocks that will be considered. The constraints chosen are those inherent in the AFM projection developed for pelitic gneisses of the Gananoque area<sup>6</sup>. Essentially this amounts to considering only those assemblages that always contain quartz, K-feldspar, plagioclase, magnetite, and ilmenite. The AFM projection in Figure 1 shows tentative phase relations for granulites from the southwest corner of the Westport map-area<sup>2</sup>. This type of representation not only serves as a convenient working diagram for interpreting phase relations suggested by natural associations, but also indicates what possible reactions among phases could be expected. Further analytical work is required to decide whether or not this form of projection has rigorous application to granulite assemblages, particularly in view of the assumptions involved in its derivation. One main advantage of this diagram is the ability to display variations in  $Fe^{+2}/(Fe^{+2} + Mg)$  of both rocks and minerals. It is also well adapted for presentation of assemblages from pelitic rocks and charnockites. One important aspect emphasized by the AFM projection in Figure 1 is the apparent necessity of having biotite as a stable associate in granulite facies metamorphism. If this were not the case, we should expect the association sillimanite-hypersthene and this appears to be extremely uncommon.

Another popular method of portraying compositional relationships between coexisting mineral phases from metamorphic rocks is by means of distribution diagrams. The theory of element partitioning between coexisting minerals has been treated extensively by Kretz<sup>7</sup> as well as others. It is generally accepted in applying this concept that any systematic equilibrium partitioning of elements between coexisting phases will be mainly temperature dependent, such that on a distribution diagram having co-ordinates of the type shown in Figure 2, one could expect a family of curves representative of different temperatures. Unfortunately, most analyses of coexisting minerals from granulites come from rocks collected from different localities, and in attempting to apply the principle of element partitioning we are confronted with interpreting correlations from a number of scattered points on a distribution diagram without knowing the characteristic shape of curve or the temperature sensitivity registered by displacements between curves. This problem is adequately demonstrated in Figure 2 which shows the distribution of

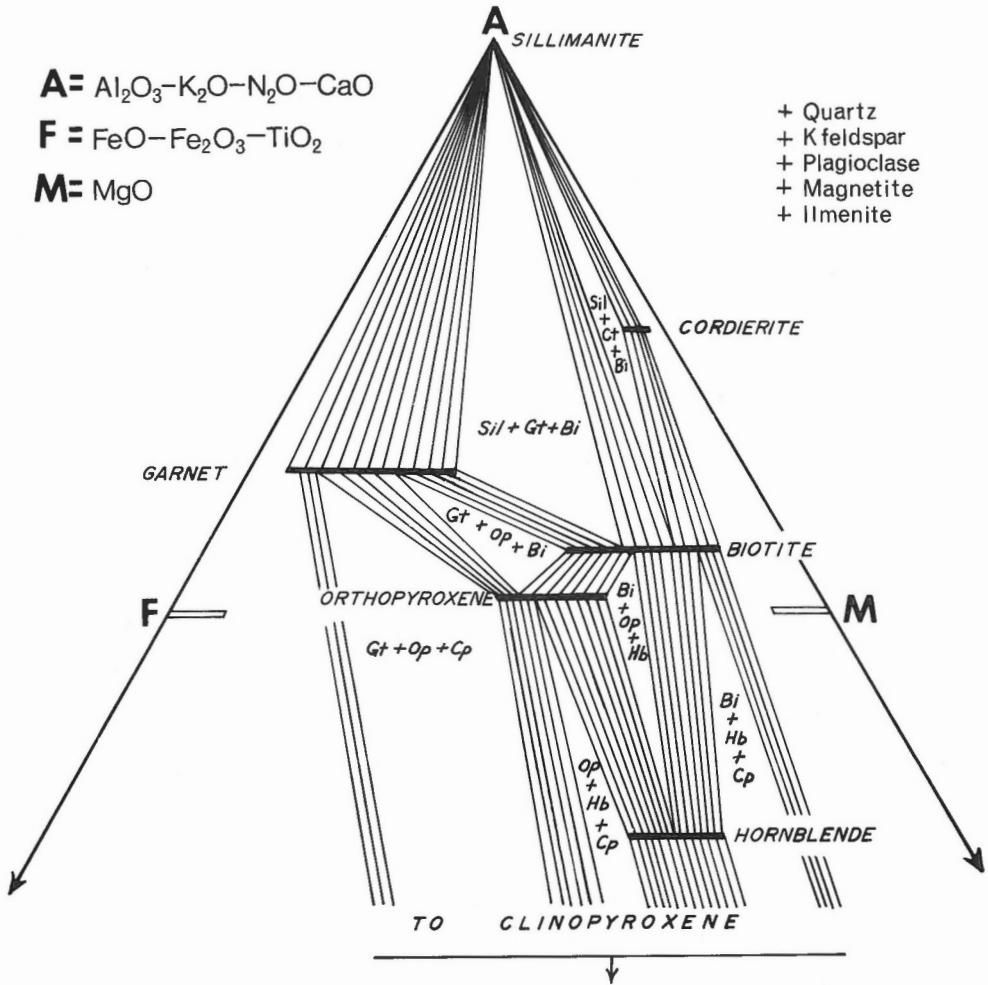

Figure 1. Tentative interpretation of phase relation for gneisses and granulites from the vicinity of Clear Lake, Westport area, shown on an AFM projection for idealized conditions of constant  $T$ ,  $P_1$ ,  $P_w$ , and  $P_0$ . The construction is based on associations observed in this study as well as those given by Wynne-Edwards<sup>2</sup>.

$\text{Fe}/(\text{Fe} + \text{Mg})$  between biotite and orthopyroxene based on analyses taken from the literature. Other problems involved in this approach are: the assumption that equilibrium was attained with respect to the mineral phases chosen, the value of absolute temperature represented by a given curve, and the possibility of parameters other than temperature having significant effects. In effort to minimize the above mentioned uncertainties in studying the partitioning of  $\text{Fe}^{+2}$  and  $\text{Mg}$  between coexisting biotite and orthopyroxene from Grenville granulites, we decided on the following procedure:

1. To sample biotite-orthopyroxene associations over small areas in selected localities so that  $P_1$  and  $T$  can be assumed constant for all assemblages from a given locality.

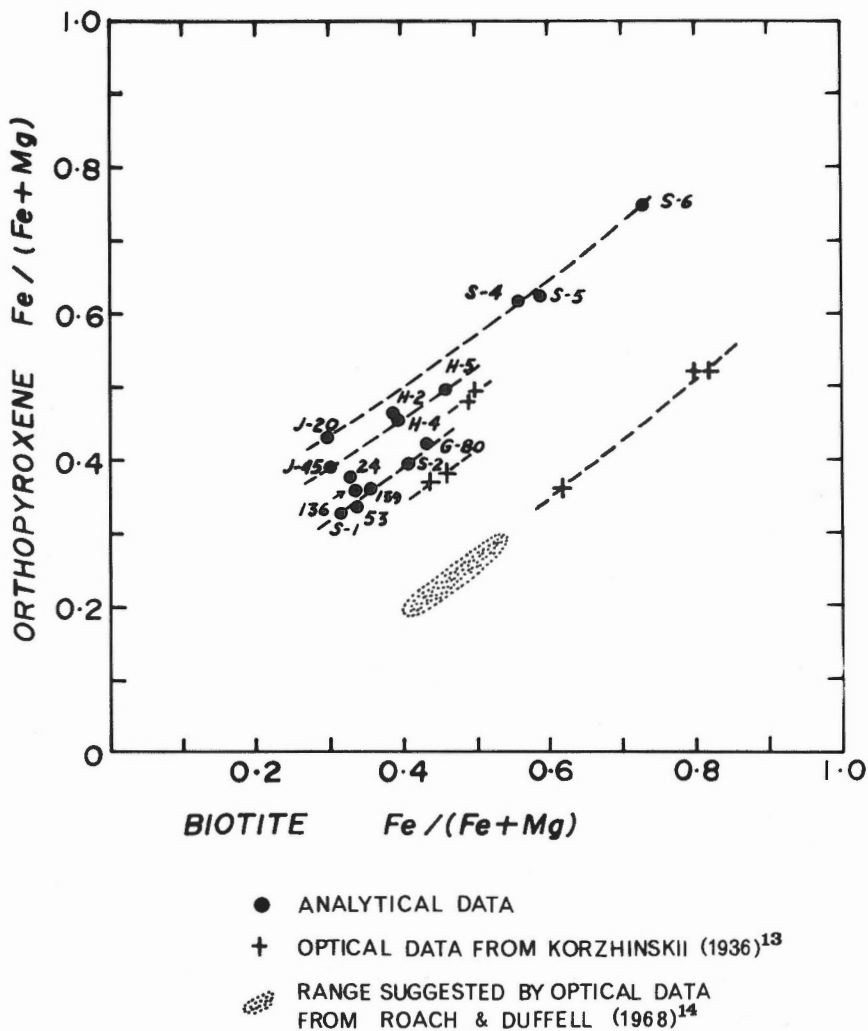
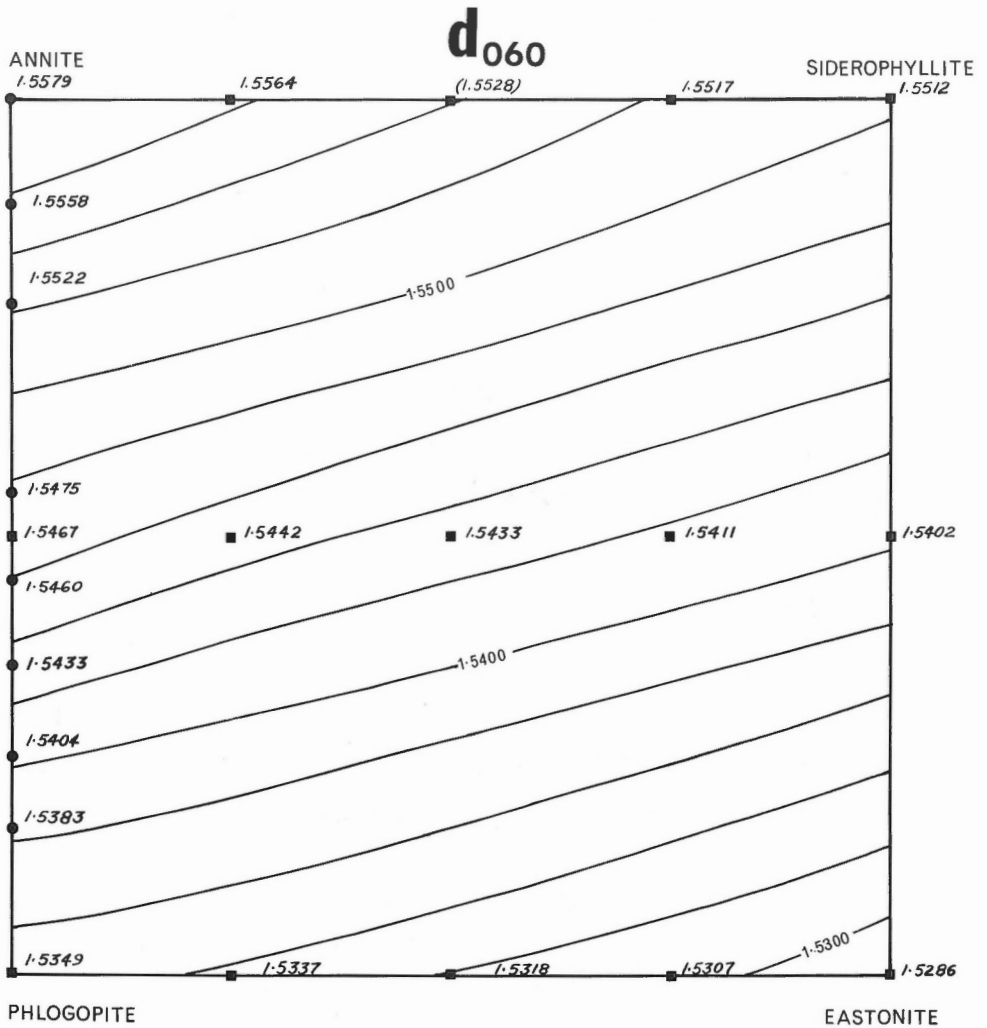

Figure 2. Partitioning of Fe and Mg between coexisting biotite and orthopyroxene from granulites and charnockites. Sources for analyzed mineral pairs (solid circles) are as follows:

- Groves<sup>8</sup>: G-80; Uganda, East Africa.
- Jen<sup>9</sup>: prefixed 'J'; Tichborne area, Ontario.
- Himmelberg and Phinney<sup>10</sup>: prefixed 'H'; Granite Falls-Montevideo area, Minnesota.
- Saxena<sup>11</sup>: prefixed 'S'; Varberg area, Sweden.
- Reinhardt<sup>12</sup>: no prefix; Gananoque and Westport areas, Ontario.

One possible interpretation of distribution relationships is suggested by the broken-line curves.



Contour interval 0.002 Å

- Data from this study
- Data from Wones (1963, p.1310)

Figure 3. Variation of  $d_{060}$  (Å) with biotite composition in the range annite-siderophyllite-eastonite-phlogopite based on preliminary data from this study and that published by Wones<sup>16</sup>.

2. To prepare, using hydrothermal equipment, synthetic biotite and orthopyroxene of known compositions appropriate to those of the natural counterparts.
3. To conduct reaction experiments using the synthetic phases in the presence of aqueous chloride solutions in a manner similar to that of Medaris<sup>15</sup> for olivine-orthopyroxene, so as to determine the nature of Fe<sup>+2</sup> and Mg partitioning between the synthetic phases under controlled T, P<sub>1</sub>, and P<sub>0</sub>.
4. To interpret conditions of metamorphic crystallization in naturally-occurring Grenville granulites on the basis of data obtained from the reaction experiments.

Synthesis work to date consists of successful crystallization of fifteen biotites and one magnesium orthopyroxene. The mica compositions are within the range defined by, and including the end-members: annite, siderophyllite, eastonite, and phlogopite. The starting mixes consisted of fired gels prepared from standardized reagents. Iron-bearing compositions were reduced in a hydrogen furnace with the result that an oxidation state comparable to the wüstite-magnetite assemblage was established during crystallization. Synthesis runs were done in cold seal vessels at temperatures ranging from 560°C to 900°C and at total fluid pressures between 1000 and 2000 bars. Preliminary powder X-ray diffraction measurements have been made for all micas synthesized and cell parameters have been calculated. Figure 3 summarizes data for the d-spacing of the plane, (060). These results indicate that the b-cell dimension is largely controlled by the Fe/Mg ratios of the biotites. This parameter can therefore be used to determine the compositions of biotites in experiments involving the exchange of Fe and Mg between coexisting silicates.

- 
- <sup>1</sup> Wynne-Edwards, H.R.: Gananoque map-area, Ontario; Geol. Surv. Can., Map 27-1962 (1962).
  - <sup>2</sup> Wynne-Edwards, H.R.: Westport map-area, Ontario, with special emphasis on the Precambrian rocks; Geol. Surv. Can., Mem. 346 (1967).
  - <sup>3</sup> Wynne-Edwards, H.R.: The Fontenac Axis, in Geology of parts of eastern Ontario and western Quebec; Geol. Assoc. Can. Guidebook, p. 76, (1967).
  - <sup>4</sup> de Waard, Dirk: Reply in Discussion: Analysis of equilibria involving garnet in rocks of granulite facies by S.K. Saxena; Am. J. Sci., vol. 267, p. 530 (1969).
  - <sup>5</sup> Tilley, C.E.: Enderbite, a new member of the charnockite series; Geol. Mag., vol. 73, pp. 312-316 (1936).
  - <sup>6</sup> Reinhardt, E.W.: Phase relations in cordierite-bearing gneisses from the Gananoque area, Ontario; Can. J. Earth Sci., vol. 5, pp. 455-482 (1968).
  - <sup>7</sup> Kretz, Ralph: Some applications of thermodynamics to coexisting minerals of variable composition. Examples: orthopyroxene-clinopyroxene and orthopyroxene-garnet; J. Geol., vol. 69, pp. 361-387 (1961).

- 8 Groves, A.W.: The charnockite series of Uganda, British East Africa; Quart. J. Geol. Soc. London, vol. 91, pp. 150-207 (1935).
  - 9 Jen, L.S.: Petrochemical study of amphibolitic gneisses from the Tichborne and Westport areas, southeastern Ontario; unpubl. M.Sc. thesis, Queen's Univ., Kingston, Ontario (1967).
  - 10 Himmelberg, G.R. and Phinney, W.C.: Granulite facies metamorphism, Granite Falls-Montevideo area, Minnesota; J. Petrology, vol. 8, pp. 325-348 (1967).
  - 11 Saxena, S.K.: Chemical study of phase equilibria in charnockites, Varberg, Sweden; Am. Mineralogist, vol. 53, pp. 1674-1695 (1968).
  - 12 Reinhardt, E.W.: Phase relations of cordierite, garnet, biotite, and hypersthene in high-grade pelitic gneisses of the Gananoque area, Ontario; unpubl. Ph.D. thesis, Queen's Univ., Kingston, Ontario (1965).
  - 13 Korzinkii, D.S.: "Paragenetic analysis of quartz-bearing calcium-poor schists of the Archean complex of southern Pribailal'e"; Zap. Vses. Mineralog. Obshchestva, vol. 65, pp. 247-280 (1936).
  - 14 Roach, R.A. and Duffell, S.: The pyroxene granulites of the Mount Wright map-area, Quebec-Newfoundland; Geol. Surv. Can., Bull. 162 (1968).
  - 15 Medaris, L.G.: Partitioning of  $Fe^{++}$  and  $Mg^{++}$  between coexisting synthetic olivine and orthopyroxene; Am. J. Sci., vol. 267, pp. 945-968 (1969).
  - 16 Wones, D.R.: Physical properties of synthetic biotites on the join phlogopite-annite; Am. Mineralogist, vol. 48, pp. 1300-1321 (1963).
-

MINERAL DEPOSITS

21. SERPENTINITES AS POTENTIAL SOURCES OF NICKEL

Project 630037

O.R. Eckstrand

The purpose of this note is to call attention to the fact that much of the nickel content of serpentinized ultramafic rocks occurs in mineralogical forms other than serpentine; and that, because of mineralogy and technological advances in mining and treatment of ores, some serpentinite bodies could in the future become exploitable for their nonserpentine nickel content.

Native Nickel-Iron

Native nickel-iron (or awaruite, approximately  $Ni_3Fe$ ) in serpentinized ultramafic rocks could constitute a significant potential source of nickel. E.H. Nickel<sup>1</sup> and J.A. Chamberlain<sup>2</sup> have demonstrated that nickel-iron is a common mineral, resulting from serpentinization in a number of asbestos-producing ultramafic masses in the Eastern Townships of Quebec\*, and in the Muskox intrusion<sup>2</sup>. In four samples investigated by Nickel, approximately one-half of the original rock's nickel content was converted to nickel-iron and the remainder to slightly nickeliferous serpentine. It is reasonable to expect that there are other occurrences in which the conversion to nickel-iron may be more complete. However there is little published information on the abundance of nickel-iron in ultramafic rocks.

Two factors tend to make native nickel-iron an attractive potential source of nickel:

1. Open-pit mining methods. Because of its probable origin through serpentinization, native nickel-iron mineralization is likely to be widespread and uniform, and resulting 'ore' is likely to constitute large portions of some ultramafic intrusive masses. Reserves of individual orebodies could be in the order of tens (perhaps hundreds) of millions of tons, with low waste:ore ratios. Mining costs should therefore be low. This is in contrast to the high costs of selective mining methods usually required by nickel sulphide deposits associated with ultramafic rocks.
2. Magnetic methods for concentrating the ore. Native nickel-iron is magnetic; and therefore may lend itself to relatively inexpensive magnetic concentration methods. (Magnetite is almost certain to be present, and may represent a valuable recoverable by-product, or a troublesome contaminant).

However there are some serious uncertainties that must be resolved, before it is known whether nickel-iron occurrences have economic potential. The two most important are grade and grain size. As regards

---

\* Confirmed by some recent unpublished work by G. Siddeley of the Geochemistry Section, Division of Economic Geology and Geochemistry.

grade, the nickel content of ultramafic rocks usually lies in the range 0.1 to 0.3 per cent, rarely as high as 0.4 to 0.5 per cent, and averaging about 0.2 per cent. It is clearly desirable that the target ultramafic body have a high nickel content, and that a large proportion of the nickel occur as native nickel-iron. Consequently, in a favourable circumstance, a large tonnage of serpentinite might have 0.4 per cent total nickel, of which 75 per cent is in nickel-iron form, yielding a grade of 0.3 per cent 'available' nickel. This is obviously rather low grade material. However, it should be pointed out that several porphyry copper deposits presently in various stages of development and production in British Columbia have a rock-in-place value per ton that is only one-half to two-thirds the value of 0.3 per cent nickel 'ore'.

The grain size of nickel-iron in the previously-mentioned occurrences studied by Nickel<sup>1</sup> and Chamberlain<sup>2</sup> is extremely fine, most grains falling in the range 2-100 microns. Consequently very fine grinding will be necessary for liberation. Subsequent concentration may be problematic, but encouragement is offered by the example of successful fine grinding (to -500 mesh, approximately) and magnetic concentration of taconite iron ores.

Possible by-products of such an ore might be magnetite and chromite. Unfortunately, because the background copper content of ultramafic rocks is extremely low, it is unlikely that copper would be a recoverable by-product.

Low grades and fine grain-size will undoubtedly give rise to problems of metallurgical recovery, but because of cheap mining and magnetic concentration methods, nickel-iron occurrences in serpentinites may offer significant potential as a source of nickel. Given the present and projected future market for nickel, it would seem that serious efforts to evaluate this potential are justified.

#### Nickel-bearing Sulphides

Much of what has been stated here concerning native nickel-iron is applicable to heazlewoodite ( $\text{Ni}_3\text{S}_2$ ), pentlandite ( $(\text{Fe}, \text{Ni})_9\text{S}_8$ ), and millerite ( $\text{Ni}_3\text{S}_2$ ), all of which are known to occur as fine disseminations in serpentinites. The mineral, heazlewoodite, has been shown to occur commonly as a product of serpentinization in several of the same or similar asbestos-producing ultramafic masses that contain nickel-iron in Quebec's Eastern Townships<sup>2</sup>. Apparently heazlewoodite, instead of nickel-iron, resulted where sufficient sulphur was available during serpentinization. The same may be true of the other sulphides. Considerations in evaluating economic potential of these finely disseminated nickel sulphides would be much the same as for native nickel-iron except that other methods of concentration (perhaps flotation - collection) would be required.

---

<sup>1</sup> Nickel, E. H.: The occurrence of native nickel-iron in the serpentine rock of the Eastern Townships of Quebec Province; *Can. Mineralogist*, vol. 6, Pt. 3, pp. 307-319 (1959).

<sup>2</sup> Chamberlain, J. A.: Heazlewoodite and awaruite in serpentinites of the Eastern Townships, Quebec; *Can. Mineralogist*, vol. 8, Pt. 4, pp. 519-522 (1966).

<sup>3</sup> Chamberlain, J. A., McLeod, C. R., Traill, R. J. and Lachance, G. R.: Native metals in the Muskox intrusion; *Can. J. Earth Sci.*, vol. 2, pp. 188-215 (1965).

---



22. SOME COPPER OCCURRENCES IN  
YOUNGER SEDIMENTARY ROCKS OF THE  
COPPERMINE RIVER AREA, NORTHWEST TERRITORIES

Project 600009

R. V. Kirkham

These occurrences represent a type of mineralization that is not well known in the Coppermine River area (Fig. 1) and have certain similarities to some major stratiform copper deposits of the world. However, the particular showings described do not appear to be of immediate economic interest.

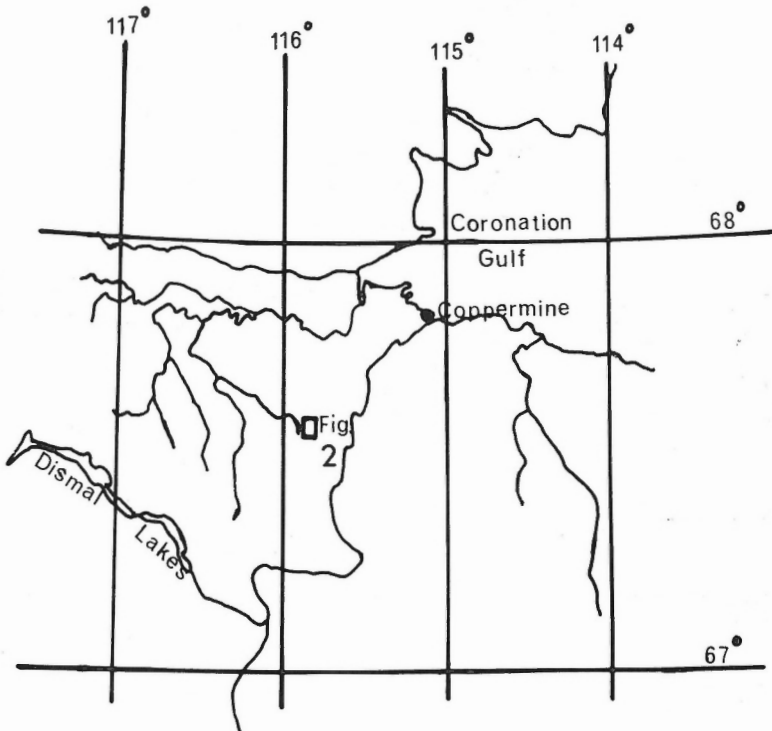

Figure 1. Index map.

During the course of regional mapping Baragar discovered the mineralization at showing 3<sup>1, 2</sup>. This and other showings indicated on Figure 2 were examined briefly by the writer as part of a general study of copper deposits of the Coppermine River area being carried out by E. D. Kindle and the writer<sup>2</sup>. The area described in this report is about 7 miles northwest of the junction of Husky Creek and Coppermine River and about 30 miles southwest of the Village of Coppermine on Coronation Gulf.

This region has undoubtedly been extensively prospected by a number of mining companies. Assessment reports indicate that some companies were previously aware of this type of mineralization. The three drillholes shown in the northwest part of the area were completed early in 1969 by Giant Yellowknife Mines Ltd. and encountered only barren 'red beds' of the Coppermine River Group. Hearne Coppermine Explorations Ltd. and Coppermine River Ltd. have done extensive diamond drilling in the younger sediments a few miles to the north and northeast of the map-area. Claims in

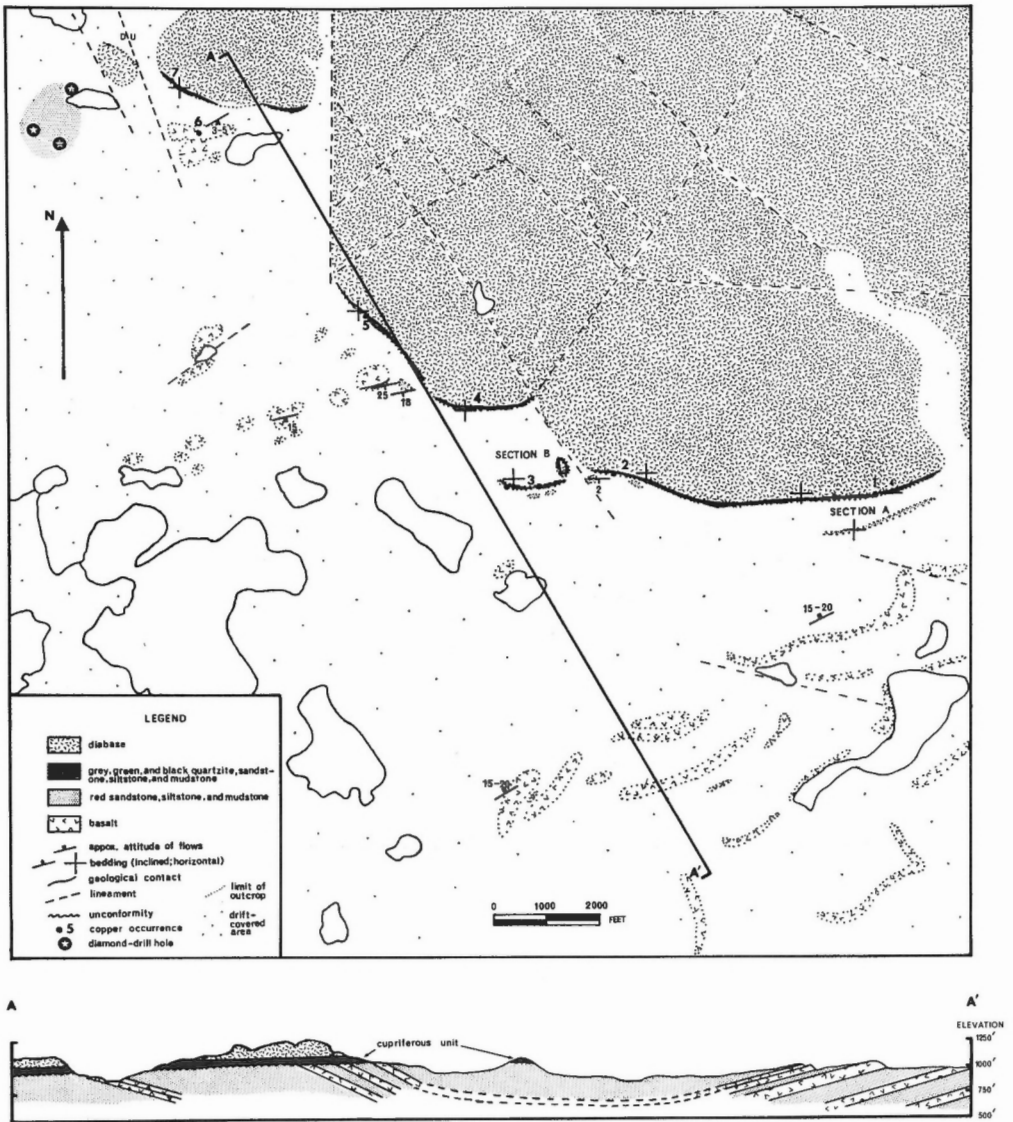

Figure 2. Geology in the vicinity of some copper occurrences in younger sedimentary rocks of the Coppermine River area, Northwest Territories.

the area are held by G. Leliever, Casino Silver Mines Ltd., A. Claussen, Giant Yellowknife Mines, and Millbank Minerals (September Mountain Copper Mines Ltd.).

The southern and northwestern part of the area is underlain by interlayered basaltic flows and 'red beds' of the Coppermine River Group as defined by Baragar<sup>3</sup>. The flows generally range from 25 to 100 feet thick and are mainly medium to dark greenish grey with brecciated, reddish and brownish amygdaloidal tops. The 'red beds' are limy, hematitic, crossbedded continental sandstones, siltstones, and mudstones. These rocks were gently folded and eroded prior to the deposition of the younger sediments (Fig. 2).

In the map-area the younger sediments consist of thinly bedded light and dark grey, drab pink, white, and greenish grey quartzites, mudstones, siltstones, silty sandstones, and silty pebble conglomerates. Desiccation cracks, channel structures, and possible rain drop impressions were noted in some units. These rocks are approximately horizontal or dip gently to the north.

The younger sediments have been intruded by a diabase sill over 100 and possibly greater than 200 feet thick (Figs. 2, 3). About 2 miles east of the map-area this sill becomes a dyke that cuts the flows and 'red beds' of the Coppermine River Group.

The younger sediments have been metamorphosed and indurated to varying degrees by the diabase, but even though in places the metamorphism has been intense, bedding and other sedimentary structures have been remarkably well preserved. Amphiboles (hornblende and actinolite?), plagioclase, quartz, garnet, serpentine, chlorite, epidote, muscovite, minor biotite, and possibly magnetite are the main metamorphic minerals. The petrographic identifications of many of the minerals were confirmed by X-ray powder photographs taken by M. Bonardi. Some dark green, hornfelsic mudstones at section B contain greater than 30 per cent fine- and medium-grained amphibole with 10 to 15 per cent magnetite. Some thinly laminated (still flaggy) metamorphosed mudstone beds at section A contain about 30 per cent medium- and coarse-grained pale green garnet porphyroblasts in a matrix containing about 60 per cent fine-grained amphibole and 10 per cent fine-grained chlorite. However, the relative amounts of the various metamorphic minerals vary widely and seem to depend largely on initial lithology.

Although general lithologies and metamorphic assemblages are variable, rocks of the younger sediments below the diabase can be divided into two main groups: (1) an upper group that varies from 10 to 70 feet thick immediately below the diabase and (2) a lower group from 10 to 50 feet thick beneath the upper group. The base of the lower group was not observed as rocks immediately above the unconformity are not exposed. The primary difference between the two is that the upper group was probably initially composed of finely laminated sandstones with only minor interlayered siltstones and mudstones; whereas the lower group was probably initially composed primarily of thinly laminated mudstones and siltstones with only minor clean sandstone.

### SECTION A

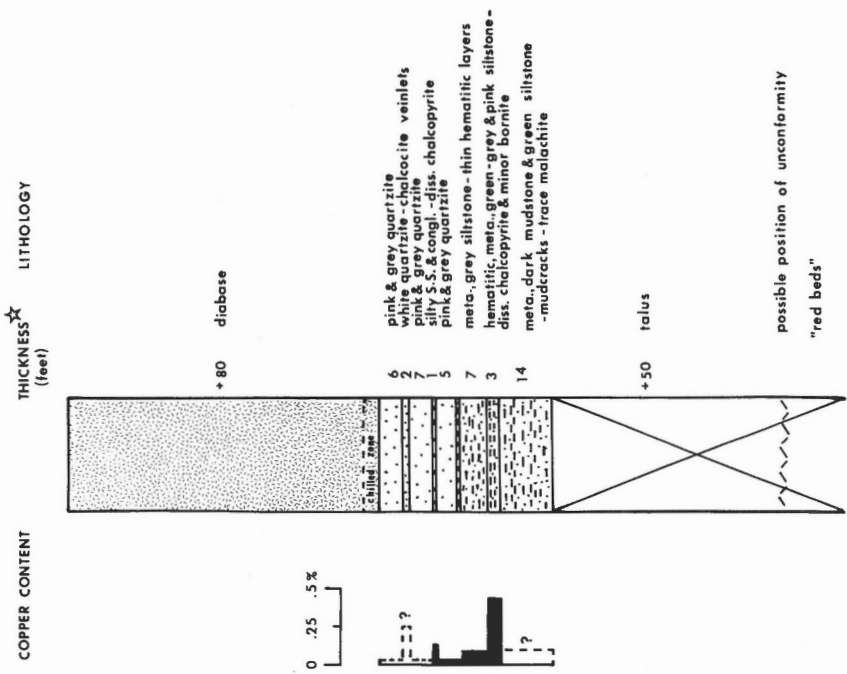

### SECTION B

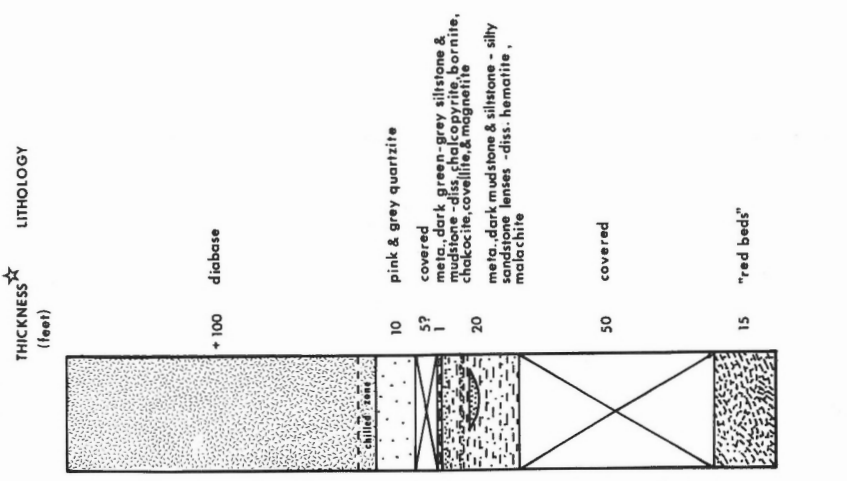

☆ visual estimate

Figure 3. Stratigraphic sections of cupriferous younger sediments.

The upper group of sediments is characterized by grey, white, and drab pink quartzites. The grey and white beds are composed mainly of recrystallized clastic quartz with minor amounts of opaque minerals, green and brown metamorphic biotite, amphibole, and sphene. The drab pink beds are composed mainly of metamorphic pink plagioclase, sericitic mica, and quartz. Possibly these beds contain minor potash feldspar as well. Except for minor quartz veinlets with copper sulphides these sediments generally have low copper content (Fig. 3).

The lower group of sediments consists mainly of metamorphosed dark and medium grey and green-grey mudstones and siltstones with only minor interlayered drab pink siltstones and grey and green sandstones and quartzites. Most rocks of this unit appear to be rich in metamorphic amphibole and in places garnet. These rocks are best exposed at and between sections A and B. There is a possibility that they pinch out to the northwest.

The numerous lineaments in the diabase (Fig. 2) and recognized faults in the younger sediments exposed along the Coppermine River indicate that although these rocks are mainly horizontal or dip gently to the north there has probably been significant faulting post-dating diabase emplacement. The difference in elevation between two knobs of diabase in the northwest corner of the map-area suggests that the south block was downdropped at least 50 and possibly 100 feet in respect to the north block.

Copper mineralization of the area occurs in two ways: (1) minor veinlets containing copper sulphides and (2) stratigraphically controlled copper sulphides. Localities 4, 5, 6, and 7 shown on Figure 2 are solely of the first type, consisting of minor quartz veinlets with chalcopyrite, chalcocite, and/or pyrite. They appear to be of no economic importance. At locality 1 there is medium grade chalcocite mineralization of this type in a 2-foot bed of white quartzite.

Stratigraphically controlled mineralization of the second type is geologically the most interesting. It appears to be confined largely to the lower sedimentary unit of the younger sediments. It is well exposed at sections A and B and is present at some points between the sections. In the area examined, chalcopyrite with subordinate bornite, chalcocite, and at a few places minor covellite (possibly of secondary origin) occur as fine disseminations and medium- and coarse-grained blebs in metamorphosed muddy and silty units. The sulphides show strong lithologic control and some tendency to be concentrated in beds and lenses with a high specular hematite or magnetite content (about 10 to 15 per cent). Some beds that were examined contain up to 10 per cent of a finely disseminated mineral that is tentatively identified as rutile. Although throughout the region chalcopyrite appears to be the main copper sulphide, at section B, bornite and chalcocite predominate in areas of higher grade mineralization.

Under the microscope it is apparent that in some specimens chalcopyrite, bornite, chalcocite, and covellite occur in close proximity. However, in most cases, the sulphides (except covellite) occur in separate grains or bornite and chalcopyrite occur together or bornite and chalcocite occur together. Mutual boundary relationships are most common but oriented chalcopyrite lamellae in bornite and graphic intergrowths of chalcocite in bornite are also common. The covellite occurs characteristically as veinlets in the other sulphides or as rims around them.

It is quite possible that extensive recrystallization and rearrangement of sulphides took place during metamorphism. The minor

copper-bearing veinlets in the upper sedimentary unit beneath the diabase could possibly have formed in this manner.

The following is a list of copper determinations on chip samples collected by the writer:

<u>Sample Number</u>	<u>Locality Number</u>	<u>Width (in feet)</u>	<u>Copper (per cent)</u>
175-1	1	1	0.13
175-2	1	5	0.02
175-3	1	7	0.08
175-4	1	3	0.44
177-1	2	6	0.09
178-1	2	1/2	0.07
50-1	3	1	0.33
50-2	3	5	0.20

X-ray fluorescence analyses by G. Lachance by the standard addition method using chalcopyrite.

Details of location of most of the samples are given on sections A and B.

The chip samples are thought to be reasonably representative of the beds tested; however, mineralization tends to be erratic and there are some obviously higher grade sections within certain units. This is especially true at sample locality 50-1, the same area where Baragar collected grab samples that contained 0.26 and 1.70 per cent copper<sup>1</sup>. The writer collected first-sized samples from this area that probably contain greater than 5 per cent copper. As a whole high grade patches appear to be quite restricted, but mineralization in this particular 1-foot bed was traced for more than 200 feet along strike.

Until more is known about the geology of these deposits, their exact origin, history, and economic importance cannot be fully evaluated. However, the fact that copper sulphides are apparently stratigraphically controlled in anoxic clastic rocks and the fact that the stratigraphic position of the deposits has many general similarities with the White Pine area in Michigan (that is, they occur in dark marine or marginal marine Proterozoic mudstones and siltstones that overlie cupriferous flood basalts and continental 'red beds') are indications that economic cupriferous shale deposits might occur somewhere in the Coppermine River area. However, much stratigraphic and other geological work is necessary to adequately test this possibility.

Without a detailed topographic survey and subsurface information it is very difficult to evaluate how much relief there is on the unconformity. However, the writer expects that the relief could be significant. Since the mineralization described occurs very close to the unconformity it should be kept in mind during any ensuing exploration that favourable beds might be absent in paleogeographic high areas along the unconformity and that there might have been many local basins along this surface.

---

<sup>1</sup> Baragar, W.R.A. and Donaldson, J.A.: Coppermine and Dismal Lakes map-areas, District of Mackenzie, in Report of Activities, Part A, April to October, 1969; Geol. Surv. Can., Paper 70-1, Pt. A, pp. 120-124 (1970).

- <sup>2</sup> Kindle, E. D. and Kirkham, R. V.: Coppermine River copper deposits, District of Mackenzie, in Report of Activities, Part A, April to October, 1969; Geol. Surv. Can., Paper 70-1; Pt. A, pp. 94-95 (1970).
- <sup>3</sup> Baragar, W. R. A.: Volcanic studies: Coppermine River basaltic flows, in Report of Activities, Part A, May to October, 1966; Geol. Surv. Can., Paper 67-1, Pt. A, pp. 26-28 (1967).
- 

23. URANIUM AND VANADIUM CONTENT  
OF ASSORTED ROCKS IN CANADA

Project 630039

E. R. Rose

During a review of laboratory investigations of the nature of occurrence of vanadium in Canada it was considered advisable to test certain suites of rock samples for uranium as well as vanadium. For uranium, this was done by measuring the radioactivity of a standard volume of powdered rock by an end window Geiger counter and comparing the rate of discharge with that of radioactive standards carrying known weights of  $U_3O_8$ , thus arriving at an estimate of  $U_3O_8$  equivalent content for the unknown rock sample. For vanadium a portion of the rock powder was fused with sodium carbonate ( $Na_2CO_3$ ), dissolved in hot nitric acid ( $HNO_3$ ), diluted, cooled, filtered, and tested with a drop or two of concentrated hydrogen peroxide ( $H_2O_2$ ).

Summary of Results

Sedimentary Rocks

Thirty samples of dark shales of Paleozoic (Ordovician?) age from the Watson Lake area of the Yukon Territory and northern British Columbia, supplied by H. Gabrielse, showed a consistent weak radioactivity giving an estimated  $U_3O_8$  (equiv.) content ranging from 0.001 to 0.006 per cent, and a vanadium content ranging from nil to 0.1 per cent.

Twelve samples of manganiferous shale of Paleozoic (Cambrian) age, from the Avalon Peninsula of Newfoundland, supplied by W. D. McCartney, showed an estimated  $U_3O_8$  (equiv.) content ranging from 0.001 to 0.006 per cent, and a vanadium content ranging from 0.01 to 0.5 per cent.

Thirty samples of dark shale collected by the writer from various localities in Canada showed faint radioactivity and faint traces of vanadium. Two samples of dark shale, one of Devonian age from Yarbo, Saskatchewan, and another of Cretaceous age from the Sikanni Chief River, British Columbia, showed a content of 0.01 per cent  $U_3O_8$  (equiv.).

## Igneous and Metamorphic Rocks

Twelve samples of gneisses of Mesozoic age from the northern part of the Coast Range, British Columbia, supplied by J. A. Roddick, showed a range from 0.001 to 0.011 per cent  $U_3O_8$  (equiv.) and a vanadium content ranging from 0.01 to 0.5 per cent.

Eight samples of graphite schists of Precambrian (Archean) age, from the Flin Flon area of northern Manitoba and Saskatchewan, submitted by D. R. E. Whitmore, showed a range from 0.002 to 0.014 per cent  $U_3O_8$  (equiv.), and from nil to 0.1 per cent vanadium.

Three hundred samples of Precambrian (Archean) volcanic rocks, mainly of basic types but ranging from basalt to rhyolite, submitted by A. M. Goodwin from greenstone belts in northern Ontario and Quebec, showed a range from nil to 0.01 per cent  $U_3O_8$  (equiv.), and from nil to 0.5 per cent vanadium. Of these, only one, a sample of rhyolite tuff or flow from the Bird Lake-Uchi Lake area of northwestern Ontario, showed as much as 0.01 per cent  $U_3O_8$  (equiv.). In general the basic rocks were slightly lower in uranium and slightly higher in vanadium than the more acidic volcanic rocks in this suite.

## 24. GEOLOGY OF CANADIAN LEAD AND ZINC DEPOSITS

Project 650056

D. F. Sangster

1. Various aspects of the writer's research on the geology of Canadian lead and zinc deposits have been drawn together in a series of papers:
  - (a) "Metallogenesis of some Canadian lead-zinc deposits in carbonate rocks" - This paper outlines the three main types of lead-zinc deposits in carbonate rocks which are recognized in Canada. Geological evidence is presented to show that ore sulphide in conformable deposits are normal, diagenetic or sedimentologic products of sedimentary basins<sup>1</sup>.
  - (b) "Geological exploration guides for Canadian lead-zinc deposits in carbonate rocks" - Attention is drawn to the fact that economic concentrations of ore minerals occur in time-rock units where they are coincident with appropriate paleogeographic position and/or tectonic overprinting. The paper concludes with a table listing ten favourable time-rock and lithologic units, together with specific geological targets, considered by the writer to hold good potential for lead-zinc mineralization<sup>2</sup>.
  - (c) "Sulphur isotopes, stratabound sulphide deposits, and ancient seas" - Data from over 100 orebodies are presented to demonstrate that most of the sulphur in stratabound ores has been bacterially derived from sea water sulphate. This implies a close association in time between deposition of host rocks and deposition of ore sulphides. The data further suggest the use of sulphur isotopes in ores as a possible means of dating ore formation. This paper to be presented to the International Association on



the Genesis of Ore Deposits (IAGOD) Meeting in Japan, 1970 and scheduled for publication in the IAGOD Volume of that meeting.

2. With the assistance of Mrs. K. L. Edmond, the amalgamation of approximately 45 published and unpublished 4-mile maps of Lower Cambrian strata in the Western Canadian Cordillera was completed. About half of these have already been reduced to 1:500,000 scale for publication to focus attention on the potential of the Lower Cambrian as a lead-zinc metallogenic time-rock unit.
3. Studies continued on the Pb- and S-isotope composition of Canadian strata-bound lead and zinc deposits. Approximately 64 sulphide minerals were mechanically separated and submitted for analysis, previous results were studied, and the literature gleaned for supporting data. Stable isotope studies of these ores are providing valuable data on their depositional environment and time of emplacement, the latter particularly so in the Precambrian.

---

<sup>1</sup> Sangster, D.F.: Metallogenesi of some Canadian lead-zinc deposits in carbonate rocks; Geol. Assoc. Can., Proc., vol. 22 (in press).

<sup>2</sup> Sangster, D.F.: Geological exploration guides for Canadian lead-zinc deposits in carbonate rocks; Can. Mining J. (in press).

---

MINERALOGY

25. REFLECTANCE, MICROINDENTATION HARDNESS AND  
ROTATION PROPERTIES OF OPAQUE MINERALS

Project 610251

C. R. McLeod

In collaboration with Dr. B. F. Leonard, United States Geological Survey, Denver, and Dr. E. N. Cameron, Department of Geology and Geophysics, University of Wisconsin, work has started on a compilation of quantitative data on reflectance, microindentation hardness, and rotation properties of opaque minerals. This compilation will be more comprehensive than a previous one<sup>1</sup>, and will supercede it. It will bring together information that is dispersed through a voluminous literature in many languages, and should provide a valuable aid in the identification of opaque minerals in polished section.

Nearly 500 mineral species will be listed, although information on all properties is not available for each species. Dr. Cameron is preparing the data on rotation properties, and Dr. Leonard and the writer are compiling the reflectance and microhardness values. Material from the literature has been supplemented by a considerable amount of unpublished and pre-publication information provided by several workers in the field. The contribution of this information and permission to use it are gratefully acknowledged.

It is intended to present the data in both graphic and tabular form, with references cited for all values used, thus providing the user with an index to source material and a lead to other mineralogical data. Publication in 1970 is anticipated.

---

<sup>1</sup> McLeod, C. R. and Chamberlain, J. A.: Reflectivity and Vickers microhardness of ore minerals; Geol. Surv. Can., Paper 68-64 (1968).

---

26. STUDY OF MICA-GROUP MINERALS AND HOST ROCKS

Project 590309

J. Y. H. Rimsaite

(1) Adsorption and Retentivity of Adsorbed and Radiogenic Argon in Heated  
Micas

The writer's systematic research on adsorption and retentivity of argon in principal varieties of chemically analyzed mica was carried on during

the past few years in connection with heating experiments on the micas. Chemical changes, resulting from oxidation of iron and dehydration, are already described<sup>1</sup>. The related papers on retentivity and adsorption of argon, and on physical properties of the heated micas are in preparation. A comparison between changes in the ratio of  $Ar^{40}/K^{40}$  in relation to potassium, oxygen and hydroxyl contents in biotite and muscovite heated under diverse experimental conditions is presented in Figure 1 (left and centre). The relationship between the proportions of adsorbed atmospheric argon and radiogenic argon (shown as the ratio  $Ar^{Atm}/Ar^{Ra}$ ) in phlogopite (Ph), biotite (B), muscovite (M), and muscovite-like alteration product ( $M^{II}$ ), which were heated in argon, is illustrated in Figure 1 (right).

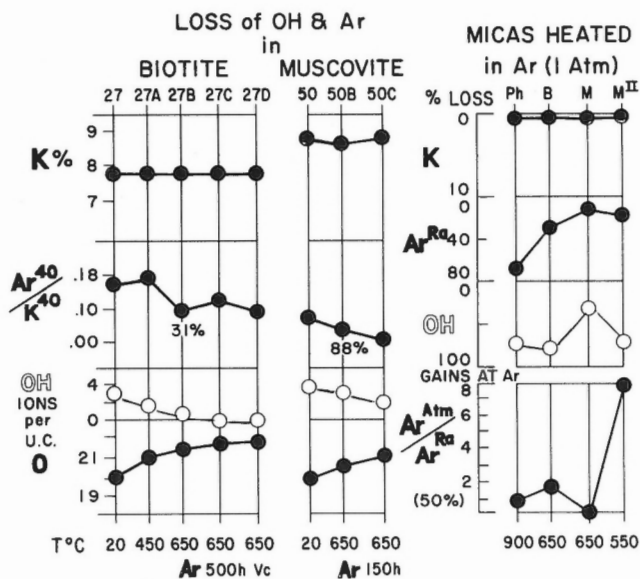

G S C

Figure 1. Loss and adsorption of argon in dehydrated micas.

The research on retentivity and adsorption of argon was extended to studies of the stability of the adsorbed atmospheric argon. Preliminary results indicate that, after reheating in air at a certain temperature, the biotite and phlogopite lose a greater proportion of adsorbed argon than of radiogenic argon. The property to adsorb and retain argon is important in connection with the application of minerals to isotopic dating. These properties were not studied systematically before, and there are no data in textbooks on retentivity and adsorption of argon.

## (2) Zoned Micas

- (a) Application of Zoned Phenocrysts to Study the Chemical Evolution of Their Host Rocks (The conclusions are based on electron probe microanalyses reported previously.)

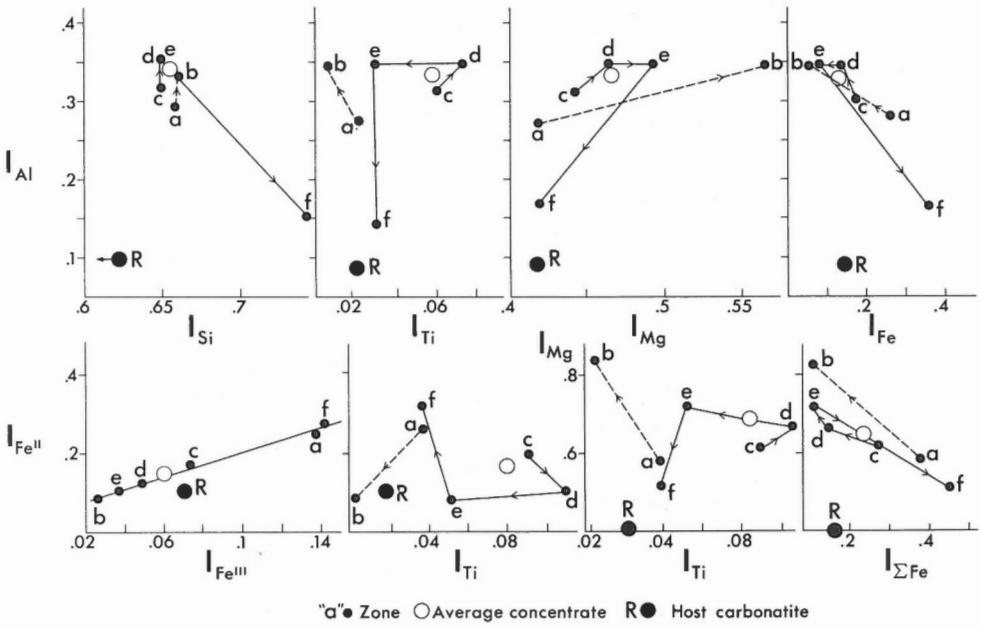

Figure 2. Distribution coefficients of major constituents between mica zones.

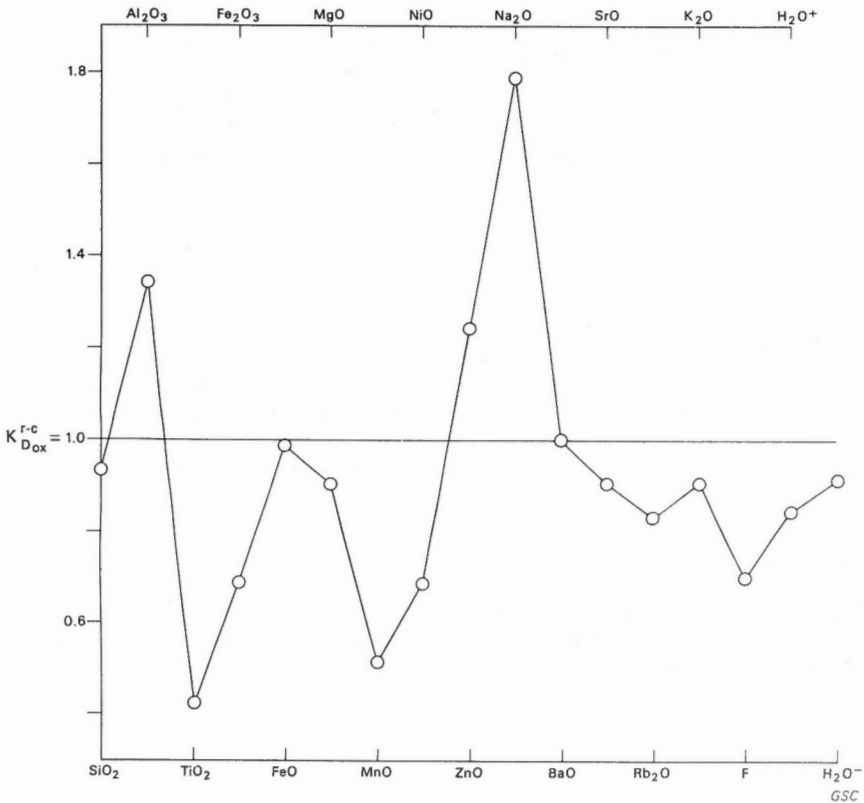

Figure 3. Distribution coefficients of major and minor constituents between phlogopite rim and core.

Zoned micas are the principal carriers of Al, Si, Mg, Ti, OH and K in the Oka carbonatite (compare average mica concentrate, open circles, and the host carbonatite, closed circles, in Fig. 2). By means of the distribution coefficients of the major constituents between the adjacent mica zones, it is possible to illustrate the chemical trends during successive phases of crystallization (Fig. 2, small circles). Gradual linear changes represent the chemical changes due to differentiation of magma, whereas abrupt changes and reversed trends result from the crystallization of Fe-Ti minerals. (More detailed discussion is given in ref. 2.)

(b) Anionic and Cationic Variations in Zoned Phlogopite

Results of complete chemical analyses of phlogopite from core 'c' and rim 'r' of zoned crystal reveal differences in anionic and cationic contents. Distribution coefficients of major and minor oxides between the rim and the core ( $K_{Dox}^{r-c}$ ) indicate a slight decrease for Si, Fe<sup>2+</sup>, Mg, K, and Sr (0.99-0.9), a greater decrease for Rb and water (0.86-0.83), a significant decrease for Ti, Fe<sup>3+</sup>, Mn, Ni, and F (0.50-0.71) and an increase for Al, Na, Zn, and O (Fig. 3). The zoned phlogopite is of mineralogical and petrological interest because, unlike most silicates, the concentrations of its iron, magnesium and titanium exhibit the same trend and an opposite trend to that of aluminium. Results of the present study provide an example of anionic variations within a single crystal. A paper has been submitted for publication.

---

<sup>1</sup> Rimsaite, J. Y. H.: Structural formulaw of oxidized and hydroxyl-deficient micas and decomposition of the hydroxyl group; *Contrib. Mineral. Petrol.*, vol. 25, pp. 225-240 (1970).

<sup>2</sup> Rimsaite, J. Y. H.: Evolution of zoned micas and associated silicates in the Oka carbonatite; *Contrib. Mineral. Petrol.*, vol. 23, pp. 340-360 (1969).

---

QUATERNARY RESEARCH AND GEOMORPHOLOGY

27. STEREOMAPPING OF THE FACE OF THE AMERICAN FALLS

Project 670038

E. B. Owen

During the period from late June to November 1969 the American Falls at Niagara Falls, New York were dewatered by a cofferdam to permit geological and engineering studies on the preservation and improvement of the waterfall. These studies are being carried out by the United States Army Corps of Engineers and Inland Waters Branch, Department of Energy, Mines and Resources under the direction of the American Falls International Board of the International Joint Commission.

At the request of the Director, Inland Waters Branch, the Geological Survey of Canada has provided geological assistance in determining the stratigraphic units and discontinuities within the rock mass of the American Falls.

A part of this assistance has been directed toward the geological interpretation of photographs of the vertical face of the falls using stereoscopic terrestrial photogrammetrical techniques. The photographs were taken with a Wild T-30 phototheodolite and were later processed through a Wild A-7 Autograph Plotter to produce topographic maps contoured in 1-foot intervals and at a scale of 1 inch to 10 feet. The stratigraphic units and fracture patterns interpreted from the photographs were then superposed on the topographic maps. The processes of erosion of bedrock exposed along the face of the falls are clearly indicated on these combined geological and topographic maps.

The stereoscopic technique is particularly suitable for a geological study of a relatively inaccessible vertical rock face such as the American Falls and thus may have application to the study of vertical faces of large excavations such as open-pit mines, quarries or dam site abutments. In addition, sequential stereophotography permits an evaluation of changes in the rock face with time and permits a calculation of the volume of material and the types of material involved in the change. This technique may be useful in mapping potential slide areas where unstable soil conditions exist. Maps prepared from photographs taken periodically will indicate the direction and amount of movement that may have taken place.

Disadvantages of the technique include the inability of the stereoplotter to plot topographic or geological data in areas covered with foliage. It is best to photograph in the spring or fall when there are no leaves on the trees. Azimuths and dips of any plane surface on a vertical face can only be approximated. Also, it would be difficult to establish a permanent base line for periodic photographs in areas of wide-spread soil instability.

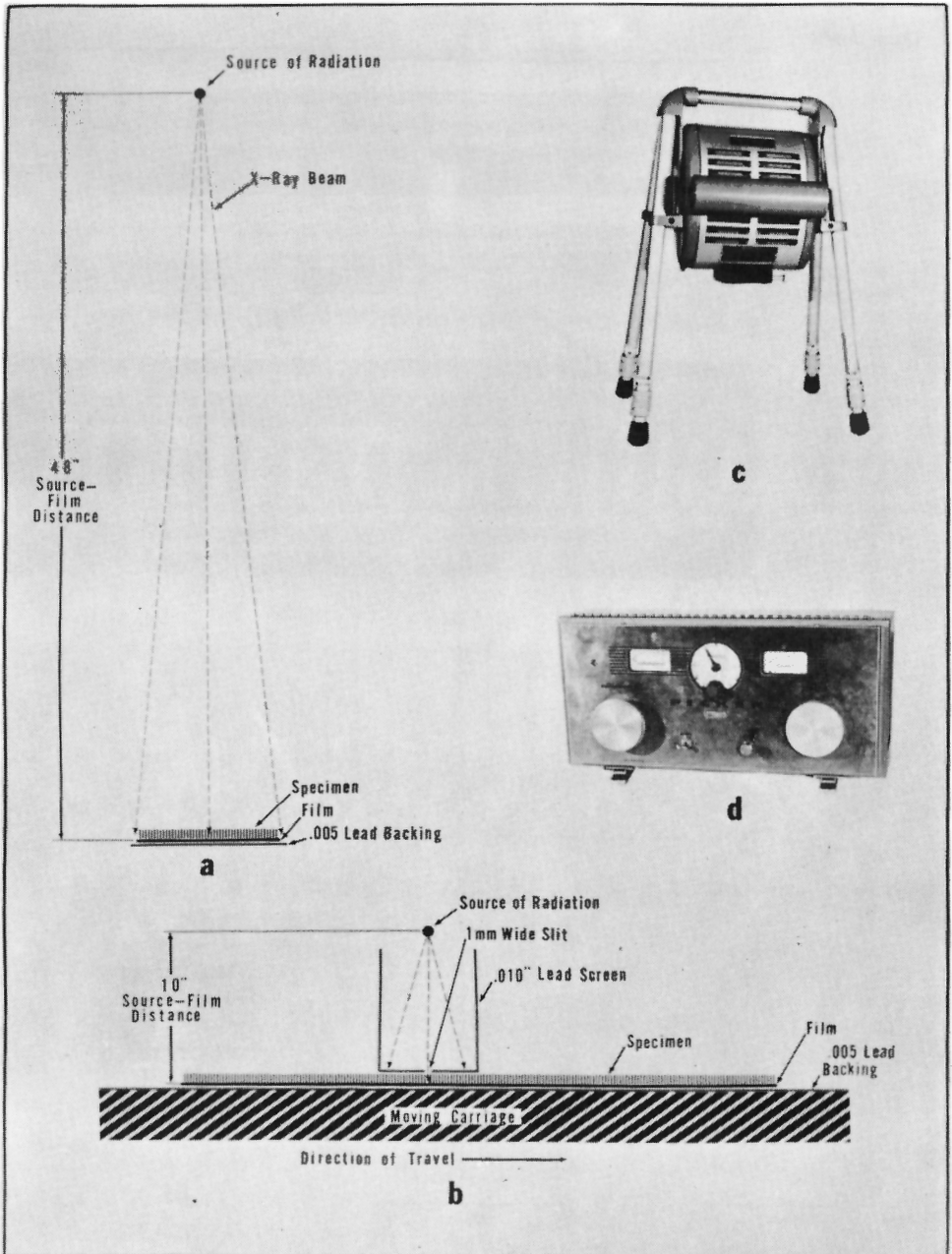

a, stationary technique;

c, X-ray tube;

b, in-motion technique;

d, electronic controls.

Figure 1. X-ray techniques and equipment.

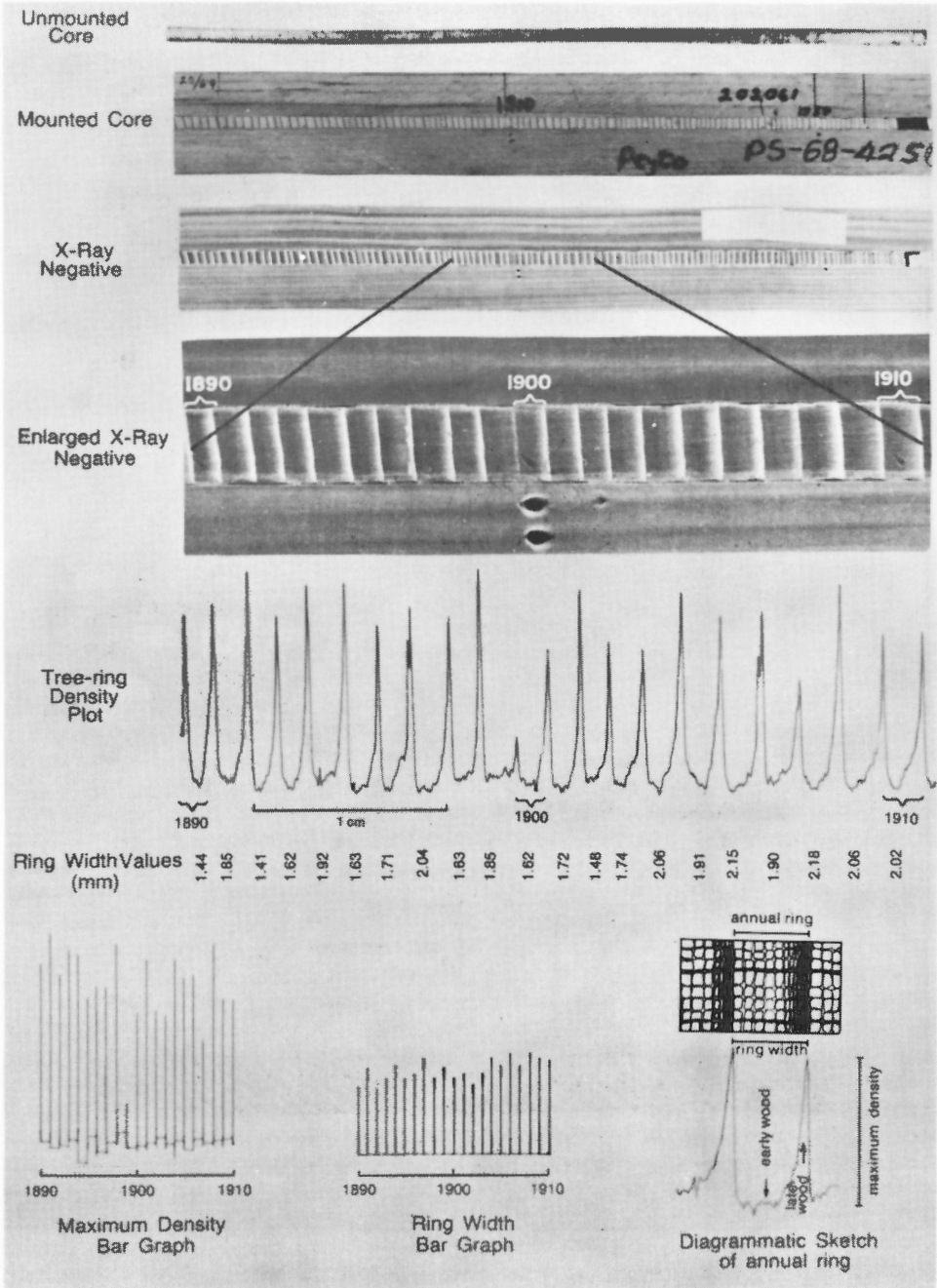

Figure 2. Tree-ring width and density data from X-ray of increment core.



### Peyto Lake Engelmann Spruce Crossdating

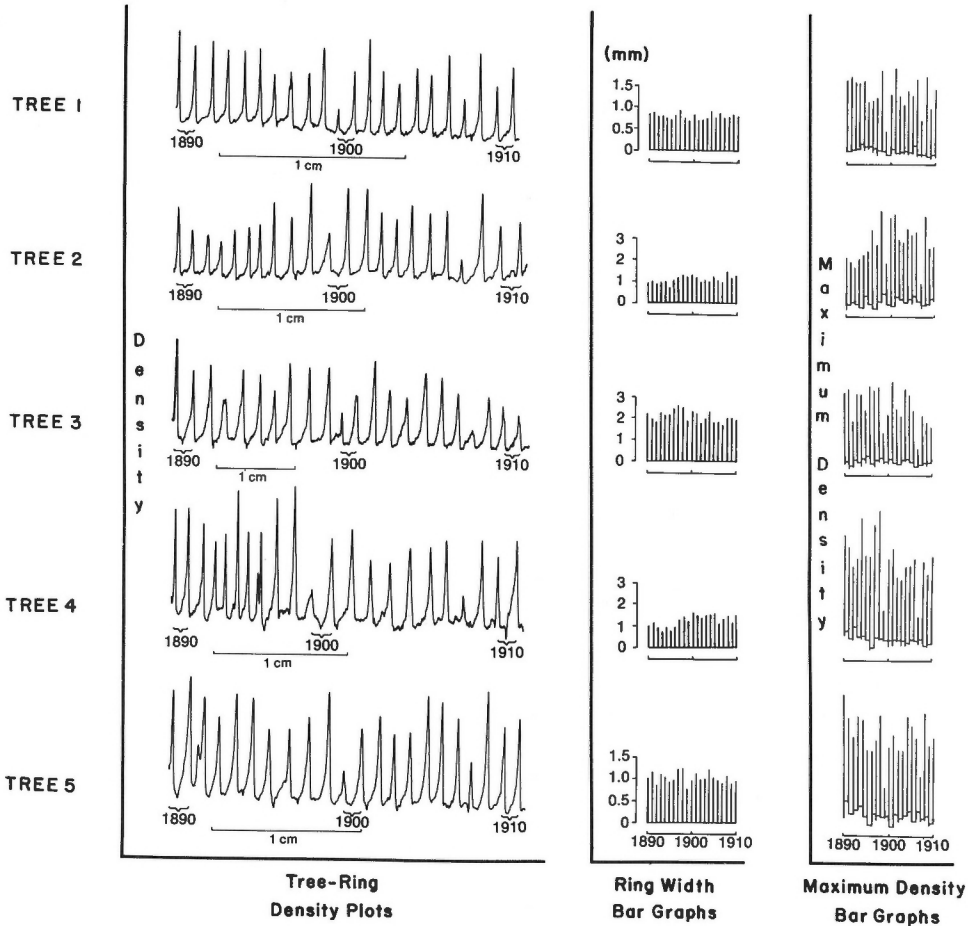

Figure 3. Comparison of ring width and ring density crossdating.

28. **SOME NEW TECHNIQUES USED IN  
DENDROCHRONOLOGICAL INVESTIGATIONS IN CANADA**

Project 680026

M. L. Parker

Several new techniques have been developed for processing dendro-chronological material. Attention has been given to developing tree-ring density analysis to supplement tree-ring width analysis for dating and climatic studies. Two methods of X-raying dendrochronological specimens (stationary technique and in-motion technique, Fig. 1) have been developed with

K. R. Meleskie, Non-Destructive Testing Laboratory, Mines Branch, New specimen preparation techniques have been used and a method of X-raying charcoal has been devised.

The Geological Survey tree-ring scanning densitometer and data acquisition system, developed with F. W. Jones, is being used to produce (1) tree-ring density plots, (2) ring-width measurements, (3) maximum-density bar graphs, and (4) ring-width bar graphs from X-ray negatives of tree-ring specimens (Fig. 2). Data processed by this method show that in some cases maximum ring density is more useful for crossdating purposes than ring-width measurements (Fig. 3). The value of many Canadian coniferous tree species for chronological and dendroclimatological purposes is enhanced by tree-ring density studies.

## 29. GEOCHEMICAL ANOMALIES IN TILL, SOUTHEASTERN QUEBEC

Project 690095

W. W. Shilts

Analyses of the  $-64\mu$  portions of more than 100 samples of till from southeastern Quebec indicate that trace element dispersal patterns closely approximate dispersal patterns of mineral grains and pebble- and cobble-size clasts<sup>1, 2</sup>. Nickel and chromium concentrations produced patterns that coincide almost exactly with dispersal shadows of ultrabasic surface cobbles, ultrabasic pebbles in till, and magnetite. The source of nickel and chromium is apparently in the ultrabasic-basic belt extending between Black Lake and Asbestos, Quebec. Nickel concentrations 50 kilometres down-ice from the presumed nickel source are as high or higher than the values reported by Kauranne<sup>3</sup> for till less than 1 kilometre down-ice from a nickel orebody in Finland.

The dispersal shadows of all components studies show predictable effects of the blocking of glacially transported debris by topographic prominences. Mounts Ste. Cécile and St. Sébastien have blocked most debris originating in the ultrabasic rocks to the northwest, causing drift deposited in their lee (southeast side) to be impoverished in all ultrabasic components.

Titanium, zirconium, vanadium, and copper were also studied. All of these elements show southeast-northwest-trending bands of anomalous concentrations, reflecting the regional movement during the last glaciation, but unique source areas could not be assigned to any except vanadium which has one apparent source near the south end of Mount Ste. Cécile. Vanadium concentrations of 100 ppm to 110 ppm in the dispersal shadow southeast of this possible source could be caused by erosion of secondary vanadium concentrations produced during sulphide weathering. Ranges of 'background' and anomalous concentrations for the trace elements investigated are recorded in Table 1.

Table 1. 'Background' and anomalous trace element concentrations for unaltered till, southeastern Quebec.

Element	Background Range (ppm)	Anomalous Range (ppm)
Chromium	56-110	130-280
Nickel	20-40	60-180
Copper	18-30	30-43
Titanium	3900-5000	5000-7000
Vanadium	61-100	100-120
Zirconium	160-400	400-620

\* Analyses obtained by emission spectroscopy; figures are expected to be accurate to  $\pm 15$  per cent of stated values; results reported for 108 samples of  $-64\mu$  fraction from C-horizon of youngest till.

Well defined dispersal shadows of till components studied during this investigation indicate source areas as far as 50 kilometres away from sample locations. Trace element anomalies are particularly strong for long distances down ice from their source areas. The data obtained during this study suggest that an integrated program of trace element, mineral, boulder, striation, and till fabric mapping can be an important tool for locating economic deposits.

---

<sup>1</sup> Shilts, W.W.: Quaternary geology of the upper Chaudière River drainage basin, *in* Report of Activities, Part A, April to October, 1968; Geol. Surv. Can., Paper 69-1, Pt. A, pp. 218-220 (1969).

<sup>2</sup> Shilts, W.W.: Indicator studies; Pleistocene geology; Lac Megantic region, Quebec, *in* Report of Activities, Part A, April to October, 1969; Geol. Surv. Can., Paper 70-1, Pt. A, pp. 185-186 (1970).

<sup>3</sup> Kauranne, L.K.: Pedogeochemical prospecting in glaciated terrain; Bull. Comm. Géol. Finlande, No. 184, pp. 1-10 (1959).

---

STRATIGRAPHY

30. SIGNIFICANCE OF AN UNCONFORMITY WITHIN THE  
CHINCHAGA FORMATION, NORTHERN ALBERTA  
AND NORTHEASTERN BRITISH COLUMBIA

Project 500336

Helen R. Belyea

The Chinchaga Formation, defined by Law<sup>1</sup>, was divided into Upper and Lower Members by Belyea and Norris<sup>2</sup>. Rice<sup>3</sup> recognized the same members in wells north of the Tathlina Uplift between latitude 62° and 63°N. Recent work has shown that the Upper and Lower Members of the Chinchaga are separated by an unconformity and that the rocks above and below belong to two separate sequences.

The lower sequence of rocks rests on granites of Precambrian age to the east and on argillites, quartzites, or sandstones of unknown age to the west. These rocks are overlain by arkoses and sandstones and, locally, by red-brown, sandy, anhydritic, dolomitic mudstones of probable Devonian age. The succeeding strata begin with the Ernestina Lake Formation composed of finely crystalline dolomites overlain by light grey anhydrite and which, in northeastern British Columbia, contains abundant coarse quartz grains. The conformably overlying red beds and salt of the Cold Lake Formation seem to be correlative with the anhydrite in the same stratigraphic position in the Evie Lake No. 1 well (Figs. 1, 2). A widespread red-bed marker horizon at the top of the Cold Lake Formation is overlain conformably by orange-red to pinkish grey anhydrites at the base of the Lower Member of the Chinchaga Formation. The red colours change upward to grey. Facies in this member change eastward from brownish grey dolomite partly altered to white, coarsely crystalline, vuggy dolomite in Evie Lake No. 1 to finely crystalline dolomite and thence to anhydrite (Fig. 2). Regardless of the facies change the member has distinctive gamma ray characteristics, certain of which have been selected to demonstrate its eastward truncation (Fig. 2). It disappears completely between wells in Township 113, Range 21, West 5 and Township 112, Range 12, West 5.

The unconformably overlying Upper Member of the Chinchaga is composed of two units. At the base is a quartz sandstone and sandy dolomite, locally conglomeratic and containing green shale partings. To the north and east sand is missing and the unit is composed largely of green or red dolomitic mudstone and dolomite<sup>3, 4</sup>. The sandy, shaly member grades up to anhydrite in the eastern part of the area and to dolomite in the western part (Fig. 2). In the line of section (see Fig. 2) the dolomite ranges from sub-lithographic to finely crystalline, but becomes fossiliferous to the north beyond the area illustrated. It grades upward to the limestones and dolomites of the Lower Member of the Keg River Formation.

The Upper Member of the Chinchaga with equivalent carbonates and the overlying Lower Member of the Keg River correlate with the Nahanni

4K, L, M, N  
94 I, J, O, P.

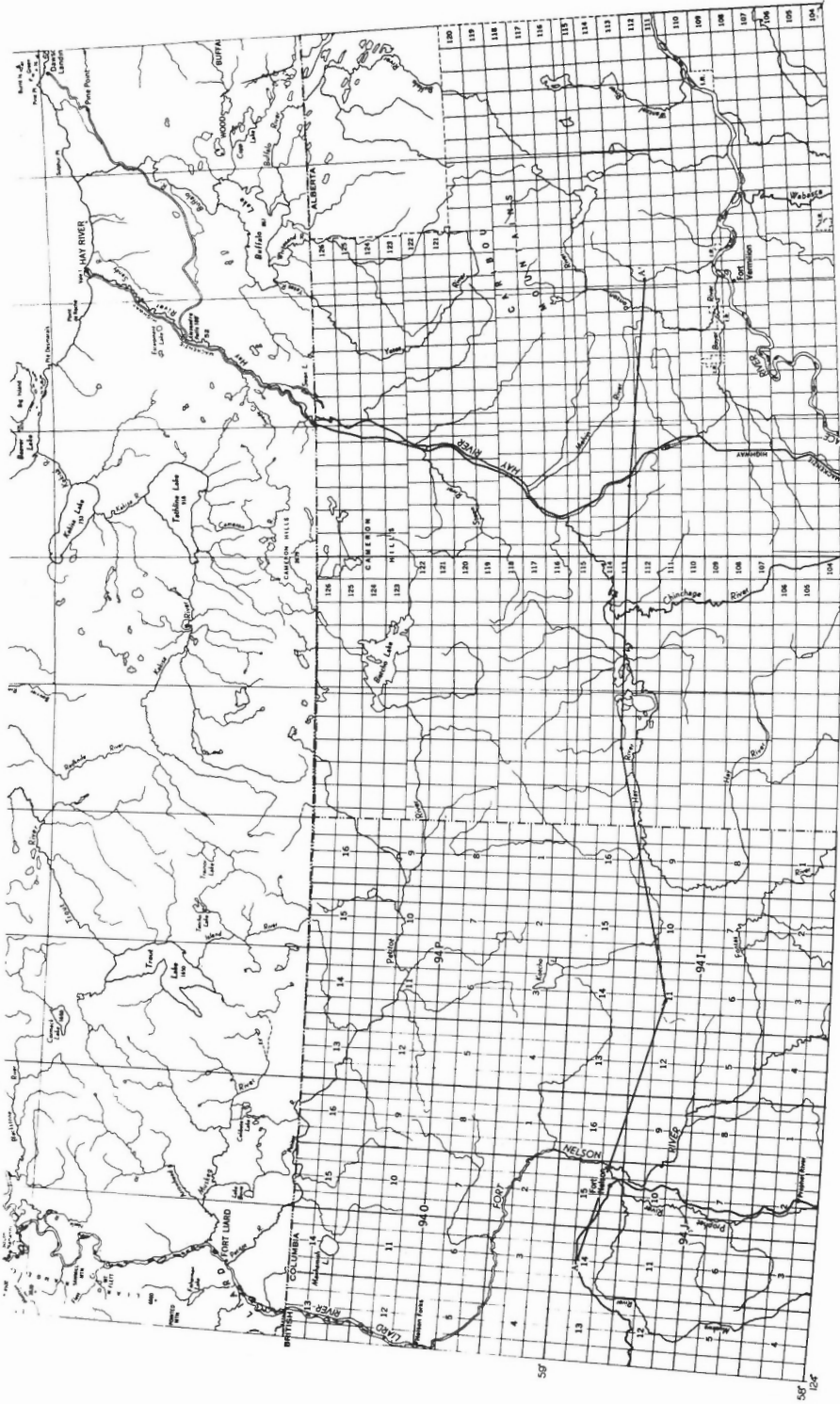

Figure 1. Index map.

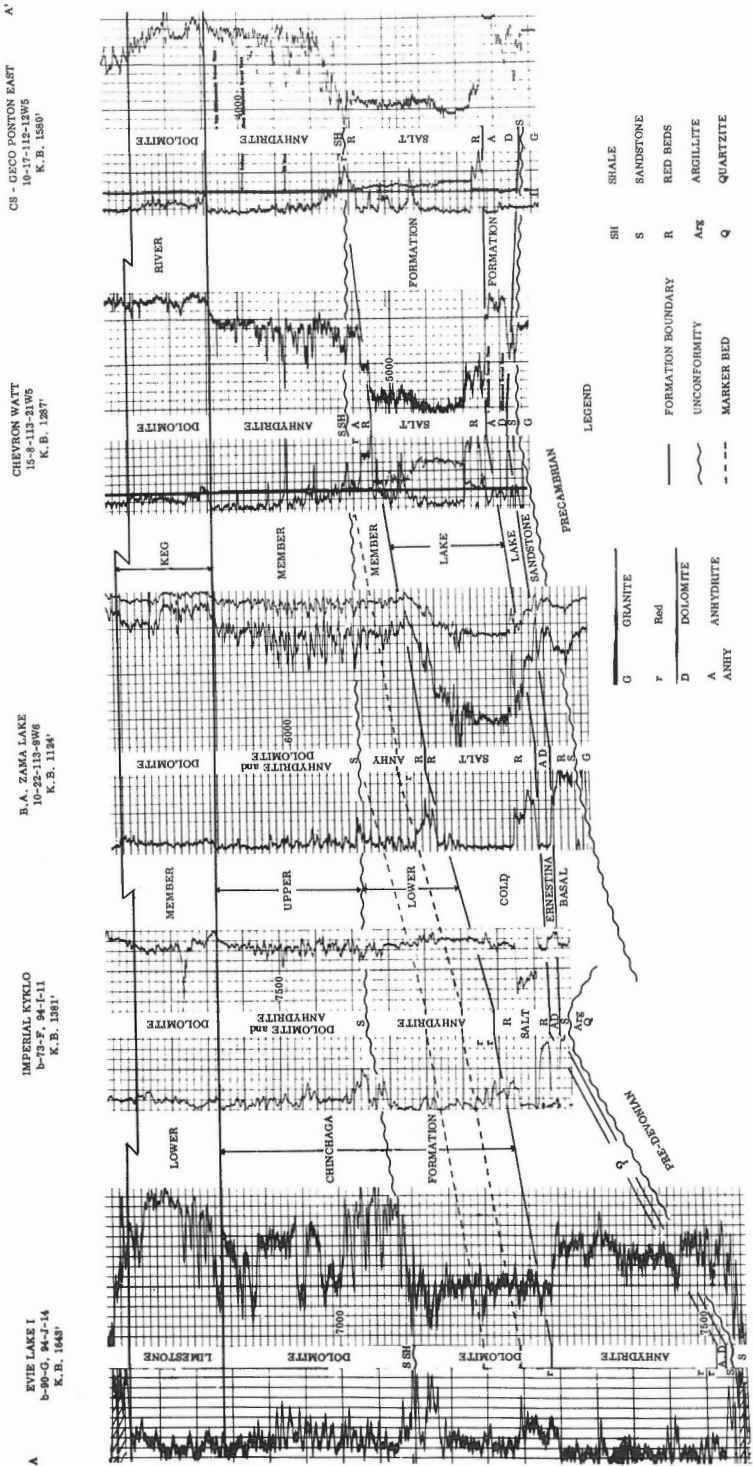

Figure 2. Correlation section, northeastern British Columbia to north central Alberta. Carbonates in the west grade eastward to evaporites accompanied by regional thinning east of Fort Nelson. The Lower Member of the Chinchaga Formation is truncated progressively eastward.

Formation of the southern district of Mackenzie and with the Dunedin of the Muncho-Summit Lake area<sup>5, 6</sup>. The age and correlation of the beds below the unconformity are uncertain as the magnitude of the unconformity to the west and northwest is unknown. Few facts are available. Rice<sup>3</sup> showed that the Ernestina Lake contains the same fauna as the Fitzgerald Formation south of Great Slave Lake and in northeastern Alberta, and that the Lower Member of the Chinchaga thickens westward north of the Tathlina Uplift. The stratigraphic position of this member plus the pattern of facies changes from evaporites in the east and northeast to carbonates in the west and northwest suggests correlation, at least in part, with the Stone Formation of the Muncho-Summit Lake area<sup>5, 6</sup> and the Landry (or Manetoe facies) and the Arnica to the northwest. Slight support for this correlation is given by the dolomitization of the Lower Member of the Chinchaga in the Evie Lake No. 1 well (Fig. 2) which is similar to that of the Manetoe and in a similar stratigraphic position. This type of dolomitization, however, occurs at many horizons in the Middle Devonian and may have no significance in this particular case. If, however, the Lower Member of the Chinchaga correlates with the Arnica (or underlies it), solution of the Cold Lake salt may be in part a cause of the brecciated member of the Bear Rock Formation (coeval with the Arnica) designated by Tassonyi<sup>7</sup> and the Cold Lake may be equivalent to the underlying evaporitic member.

- 
- <sup>1</sup> Law, J.: Geology of northwestern Alberta and adjacent areas; Bull. Am. Assoc. Petrol. Geol., vol. 39, pp. 1927-1978 (1955).
  - <sup>2</sup> Belyea, H.R. and Norris, A.W.: Middle Devonian and older Paleozoic formations of southern District of Mackenzie and adjacent areas; Geol. Surv. Can., Paper 62-15, 82 pp. (1962).
  - <sup>3</sup> Rice, D.D.: Stratigraphy of the Chinchaga and older Paleozoic formations of the Great Slave Lake area, southern Northwest Territories and northern Alberta; unpubl. M.Sc. thesis, Univ. Alberta, 139 pp. (1967).
  - <sup>4</sup> Belyea, H.R.: Middle Devonian Tectonic history of Tathlina Uplift, southern District of Mackenzie; Geol. Surv. Can., Paper (in press).
  - <sup>5</sup> Taylor, G.C.: Regional geology adjacent to the Alaska highway between Fort Nelson and Muncho Lake, British Columbia; Edmonton Geol. Soc. Guidebook, pp. 16-29 (1969).
  - <sup>6</sup> Taylor, G.C. and MacKenzie, W.S.: Devonian stratigraphy of northeastern British Columbia; Geol. Surv. Can., Bull. 186 (in press).
  - <sup>7</sup> Tassonyi, E.J.: Subsurface geology, lower Mackenzie River and Anderson River area, District of Mackenzie; Geol. Surv. Can., Paper 68-25 (1969).
-

31. BIOSTRATIGRAPHIC SUBDIVISION OF THE FIRST  
MACKENZIE RIVER DELTA EXPLORATORY BOREHOLE

Project 670068

T. P. Chamney

Location and Drilling History

107R

This is a biostratigraphic study on 12,668 feet of strata penetrated in the first borehole drilled in the Mackenzie River Delta in the Beaufort Sea region. The exploratory well, Reindeer D-27, 69°06'05"N, 134°36'54"W, was drilled by the British American Oil Company Limited, Shell Canada Limited and Imperial Oil Enterprises Limited. It is located on the southeast end of Richards Island, 34 miles north and east of the Reindeer Depot settlement and 42 miles southwest of the Tuktoyaktuk settlement. It is approximately 15 miles upstream and 5 miles west of the East Channel, from Kugmallit Bay in the Beaufort Sea. The well commenced drilling 7 August, 1965 and was completed 1 May, 1966 to a total depth of 12,668 feet with electrical logs taken from 1,510 to 12,290 feet. The drilling included a representative 10 per cent core program, numerous drill stem tests and several electrical and physical logs with all data deposited with the Canadian Department of Indian Affairs and Northern Development. The most significant hydrocarbon show was a gassy mud flow to the surface from the interval 6,838 to 6,855 feet. The operator assisted the Canadian government in placing electrical devices in the borehole prior to abandonment in order to obtain continuous permafrost data readings; in 1968 permafrost penetration was recorded to a depth of 106 feet.

Physical Stratigraphy (Fig. 1 - Depositional Intervals A to G)

Subdivision of the 12,668 feet of strata by physical methods of lithologic, electric and other type of logs, has presented much difficulty. The upper 9,000 feet of section represents modes of deposition which dumped considerable amounts of detritus of variable grain size in relatively shore intervals. The resultant "sand-shale sandwiches" and homogenous mudstone sequences provide very few persistent datums for correlation.

Eight major depositional intervals are designated on Figure 1 (intervals A to G). The geometry of the uppermost 6,960 feet which includes major depositional intervals "A" to "C", fits a delta concept of rapid deposition with rapid lateral facies change. The remaining 2,090 feet of the rapid deposition interval to the depth of 9,000 feet is represented by predominantly mudstones of rapid infilling of the late Early Cretaceous ancestral Beaufort Sea. This interval is shown as the major deposition interval "D" of Figure 1.

From the depth of 9,000 feet to the sandstone units of the Lower Cretaceous at 10,720 feet there are 1,720 feet of sediments approaching a reduced rate of deposition as represented by the major depositional interval "E". The upper boundary of this unit coincides with the first major horizon of microfauna found in descending stratigraphic succession of the borehole. Interval "F" represents 680 feet of Lower Cretaceous coarser clastics



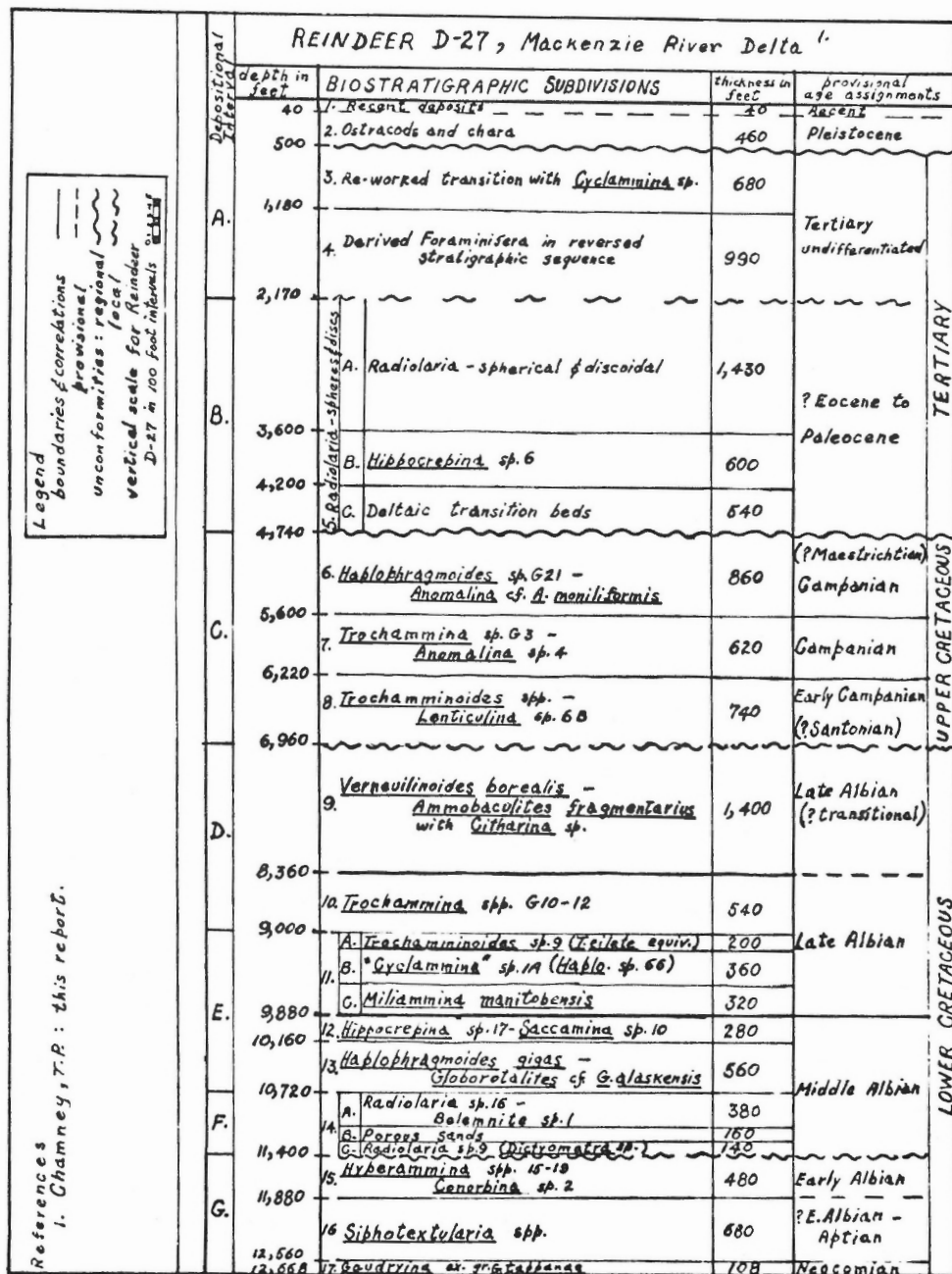

Figure 1. Summary of biostratigraphy, age and rock unit correlation.

(silts and sands) of quite normal rate of deposition for marine sands more or less distributed by longshore currents. This rock unit can be expected to be persistent laterally throughout the Arctic area of the Delta. The lowermost unit "G" represents a normal rate of deposition for mudstone lithologies with scattered minor beds of coarser clastics.

### Biostratigraphy (Fig. 1 - Biostratigraphic Subdivisions)

Subdivision of this borehole by physical stratigraphic methods alone only produces some nine gross subdivisions<sup>1</sup>; biostratigraphic research on the same section has established twenty-three subdivisions. The biostratigraphic subdivisions are interpretations of the microfossil recovery from core and drill cuttings combined with obvious physical stratigraphic changes in descending sequence of the strata penetrated. The report is primarily oriented as a contribution for subsurface correlation by establishing what is, at the present time, considered to be genetically related depositional intervals for both the fossil organic content and the deposited sediments. These subdivisions are primarily based on evidence from foraminifera and tentative international age assignments also have been interpreted on the basis of index species. Preliminary micropaleontological investigations of the sample material from this borehole already have been published<sup>2</sup>. The present biostratigraphic report is a refinement of the gross rock unit divisions previously reported. One major change is the age assignment from Late to Early Cretaceous for the most distinctive foraminiferal zone of "Cyclamina" sp. 1A. The change in age assignment became obvious when the total microfaunal sequence was plotted in distribution chart format, thus indicating the nature of re-cycled drilling mud which contributed caved or contaminated microfossil specimens. In conjunction with the above objectives of subsurface correlation and age assignment, interpretation of the paleoecology is a significant contribution in resolving genetically related depositional intervals and in turn indicating the direction of potential hydrocarbon reservoir development.

The twenty-three interpreted subdivisions of Figure 1 are designated as biostratigraphic subdivisions but both biological and physical stratigraphy are used in order to establish practical subsurface correlation units. They are for the most part selected on the basis of foraminiferal assemblages. Further application of the subdivisions with additional subsurface sections in the Delta area, may prove them to represent Assemblage Zones<sup>3</sup>. Four of these subdivisions are known to be regional index, microfossil zones. These four are subdivisions 7, 9, 11C and 13 which are respectively referable to Trochammina ribstonensis, Verneuillinoides borealis, Miliammina manitobensis and Haplophragmoides gigas. A possible fifth zonal, index species which appears to be approaching confirmation, is the subdivision 14C, radiolaria sp. 9 (Dictyometra sp.). This index species has been previously reported from the Early to Middle Albian boundary of the Yukon<sup>2</sup> and from equivalent stratigraphic horizons in Alaska<sup>4</sup>.

---

<sup>1</sup> Dept. of Indian Affairs and Northern Development: Schedule of Wells 1968, Northwest Territories and Yukon Territory; Geol. Surv. Can., pp. 31-32 (1969).

- <sup>2</sup> Chamney, T. P.: Upper Devonian to Upper Cretaceous stratigraphy of the Anderson Plains, District of Mackenzie, in Report of Activities, April to October, 1968; Geol. Surv. Can., Paper 69-1, Pt. A, pp. 229-231 (1969).
  - <sup>3</sup> American Commission on Stratigraphic Nomenclature: Code of stratigraphic nomenclature; Am. Assoc. Petrol. Geol., vol. 45, No. 5, pp. 645-665 (1961).
  - <sup>4</sup> Tappan, H.: Cretaceous biostratigraphy of northern Alaska; Am. Assoc. Petrol. Geol., vol. 44, No. 3, pp. 273-297 (1960).
- 

32.           STRATIGRAPHY AND SEDIMENTOLOGY OF THE  
              ORDOVICIAN AND LOWER DEVONIAN STRATA IN  
              PINE PASS MAP-AREA, BRITISH COLUMBIA

Project 600084

Lubomir F. Jansa

970

Introduction

A sedimentological study of Ordovician and Lower Devonian strata on Murray Range in the Rocky Mountains of British Columbia was begun during the field season of 1969. The investigation was done in association with Operation Smoky coordinated by G. C. Taylor who guided the author concerning the regional stratigraphic framework.

The purpose of the study was to: (1) establish the lithostratigraphic sequence and conditions of sedimentation for Ordovician strata; and (2) compare the carbonates of nearshore and basin slope environments as a contribution to the discussion regarding "deep water" carbonates. The best sections were found on Mount Hunter and an unnamed peak near the southeast corner of the Pine Pass map-area.

Southwest-dipping thrust sheets with a general dip of 60 degrees are the principal tectonic structures within the Murray Range. The presence or absence of specific units within any local area depends on the amount of erosion that took place prior to the sub-Devonian unconformity and on the stratigraphic intervals present in particular thrust sheets. Ten, widespread, carbonate and clastic units can be recognized in the Ordovician and four additional units in the Lower-Middle(?) Devonian. On Mount Hunter, Ordovician beds are more than 4,400 feet thick, whereas the overlying Devonian strata are 1,600 feet thick.

Stratigraphy

The Lower Ordovician Chushina Formation was, redefined by Slind and Perkins<sup>1</sup> to include all the strata between the Upper Cambrian Lynx

Formation and Monkman Orthoquartzite. On Mount Hunter this interval is 1,800 feet thick, but there includes 150-200 feet of beds at the base which relate more closely to the Upper Cambrian Lynx Formation. Fossils near the top of this interval were identified by Norford as of Early Ordovician age, Zone B. The lower part of Chushina Formation is lithologically similar to the underlying Upper Cambrian Lynx Formation.

Seven informal units were distinguished in the Chushina Formation. These are, from bottom to top, as follows (Fig. 1):

- Unit 7 Moderate brown-weathering, resistant unit; 200 feet thick.
- Unit 6 Moderate yellowish brown-weathering, resistant unit; 300 feet thick.
- Unit 5 Medium grey-weathering, cliff-forming unit; 547 feet thick (Early Ordovician age, Zone D-E).
- Unit 4 Light grey, recessive unit; nodular at top; 157 feet thick (Early Ordovician age, Zone B).
- Unit 3 Massive, resistant unit, weathering yellow-brown; 100 feet thick.
- Unit 2 Light grey, recessive, nodular unit; 360 feet thick.
- Unit 1 Basal bended unit, 100 feet thick. (Fossils from this unit have been identified by Norford as of Early Ordovician age, Zone B.)

The Chushina Formation consists of silver-grey limy shales, argillaceous calcilutites, limy quartz siltites, quartz silty calcisiltites and calcilutites, mud- and grain-supported skeletal limestones, intraformational flat-pebble conglomerates, and nodular limestones. The rocks commonly show a cyclic or rhythmic development, with beds of intraformational conglomerates at the base prograding into laminated calcisiltites with laminae of quartz silt. The top of the cyclic unit consists of papery, limy shale or thin-bedded, argillaceous calcilutite. The basal contact of a cycle is sharp and commonly erosive; within the cycle contacts are gradational. Dolomitization and silicification are common and authigenic feldspar is present.

The basal member of the Chushina Formation is considered to reflect tidal deposition whereas a basin slope - carbonate platform environment is assumed for the remainder of the formation.

#### Monkman Orthoquartzite (Unit 8, 1,350-1,045 feet)

This unit<sup>1</sup> can be mapped without interruption for 55 miles, the thickness decreasing toward the south. The contact of this sandstone with the underlying Chushina Formation is erosional, but apparently conformable. The unit consists of white- and pale brown-weathering orthoquartzites and dolomitic sandstones. The sand grains are fine to medium in size, well-rounded and medium to well sorted. Vertical worm burrows represented by Scolithus are common at some horizons. The environmental history of the

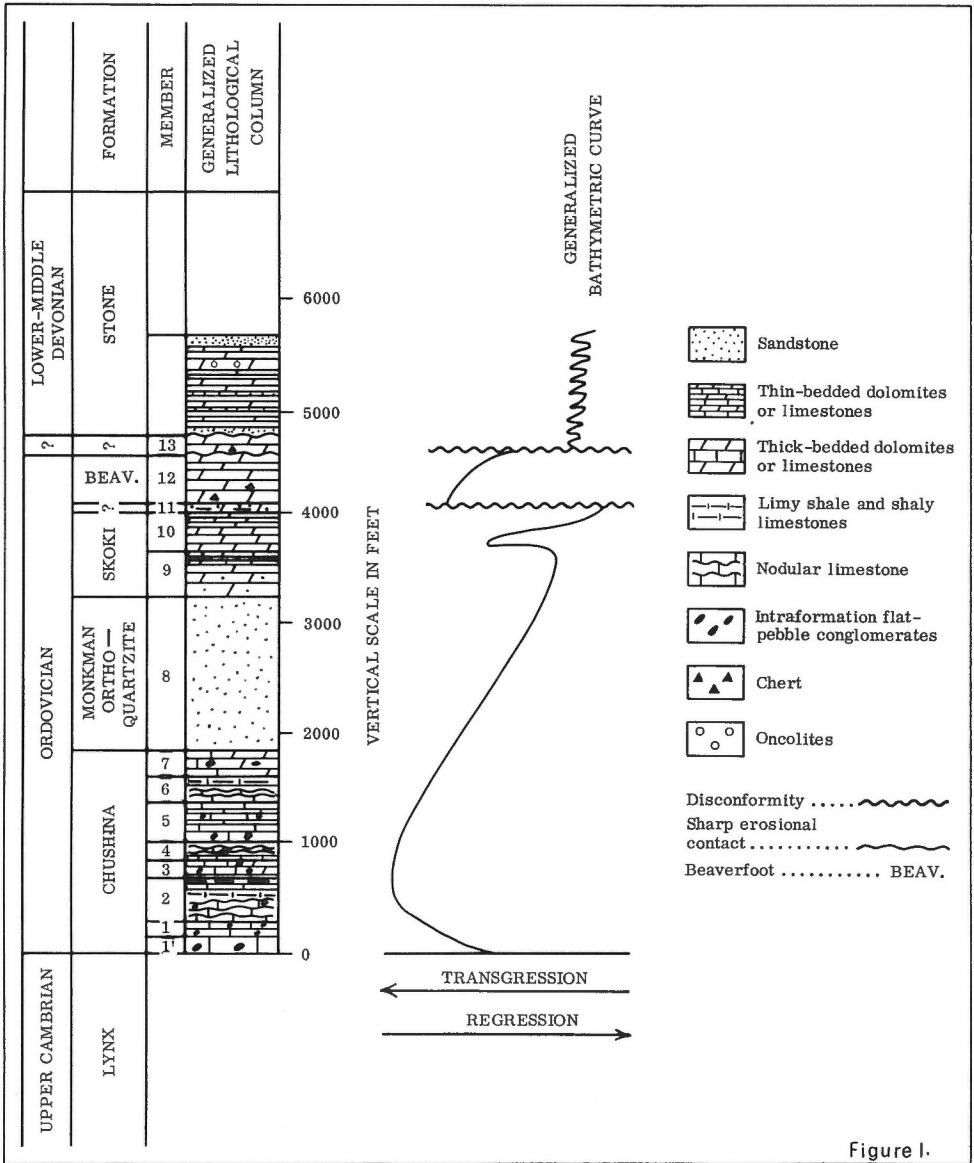

Figure 1.

sand body is complicated for it shows aeolian, beach upper shoreface, beach lower shoreface, overwash and tidal channel facies. The origin postulated for the Monkman Orthoquartzite is that of a compound offshore barrier island.

### Skoki Formation

The name Skoki Formation is used for the lower part of an interval that Slind and Perkins<sup>1</sup> called Skoki. They used the term for all rocks between

the Monkman Orthoquartzite and the Beaverfoot Formation, which is an expansion of its application in the type area of the southern Rocky Mountains<sup>2</sup>.

The Skoki Formation is 700 feet thick and comprises units 9 and 10 respectively 430 and 270 feet thick. Fossils from near the base of unit 10 were identified by Norford as belonging to the Orthidiella Zone of Whiterock age and those from the upper part of unit 10 as of Whiterock or latest Canadian age.

The formation consists of medium to dark grey dolomites of lagoonal and subtidal origin prograding into light grey dolomites with rare gypsum casts and laminae of quartz silt of an intratidal to lower supratidal origin.

#### Unit 11 - an unnamed unit of uncertain origin and correlation

Unit 11, 193 feet thick is poorly exposed. It is composed mainly of 117 feet of light grey orthoquartzites but includes recessive, dark grey dolomites. According to Norford (pers. comm.) an important stratigraphic hiatus is present above or within this unit and represents most of Middle Ordovician time.

#### Beaverfoot Formation (Unit 12, 12, 400 feet thick)

Slind and Perkins<sup>1</sup> extended the use of the name Beaverfoot northward from its type area in the southern Rocky Mountains. The Beaverfoot is quite distinct in the Mount Hunter section (Fig. 2) and its base represents a prominent Ordovician transgression. It is composed of a monotonous succession of medium to dark grey, fine to medium crystalline, fossiliferous dolomites containing silicified favositid, halysitid and horn corals as well as stromatoporoids, brachiopods and crinoids. Black and white chert is common as nodules and stringers. An 8-foot-thick biohermal body observed near the base of the formation is composed of colonial and horn corals mostly in growth position. The environment of deposition of the Beaverfoot Formation is thought to be generally infratidal to subtidal although prograding occurs in the upper part owing to regression into intratidal conditions.

#### Unit 13 (160 feet thick, age uncertain)

This unit consists of unfossiliferous, medium grey dolomites lithologically similar to the underlying Beaverfoot Formation. It contains some silty and sandy beds although these are more common in the overlying Devonian Formation. This unit is of Ordovician, Silurian or Devonian age.

#### Lower-Middle(?) Devonian (Stone Formation) (1,530 feet thick, unfossiliferous)

The base of this unit consists of 160 feet of sandstone having a sharp contact with the underlying unit 13. The sandstone is light grey, fine- to medium-grained and contains some zones of worm burrows. Strata overlying this sandstone consist of light grey dolomites with beds of dark grey dolomite, dolomitic sandstone or sandy dolomite that are interbedded in a cyclic manner. These represent cyclic oscillations of the environments on tidal flats, with some subtidal beach deposits. Light grey-weathering, light

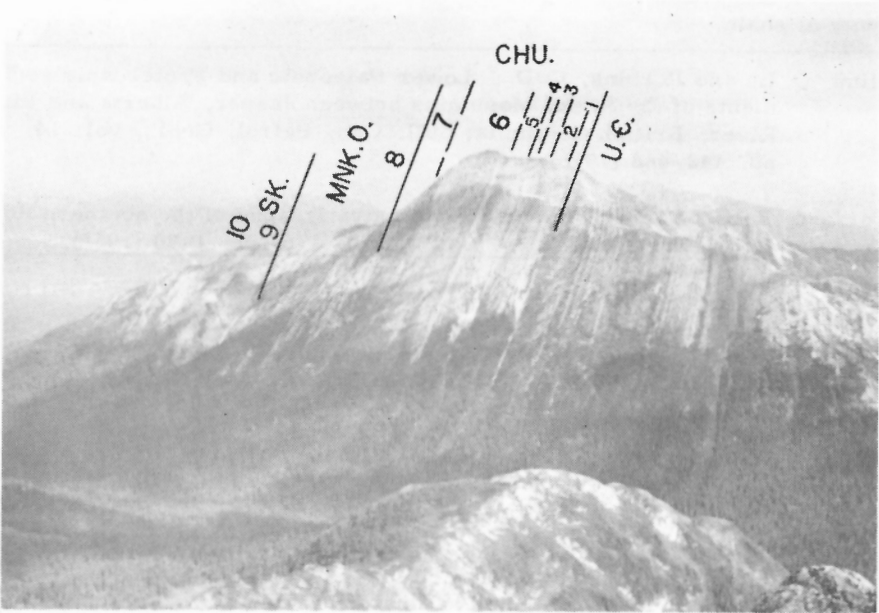

Figure 2. Ordovician and Upper Cambrian section on peak north of Mount Hunter, northeastern British Columbia. UC, Upper Cambrian; CHU, Chushina Formation; MNK. O, Monkman Orthoquartzite; SK, Skoki Formation.

brownish grey sandstone marks the top of the measured section. This is followed by a recessive unit and thrust fault bringing up Cambrian rocks formation on its base.

#### Summary

Beds at the base of the Ordovician in the Pine Pass area of British Columbia represent "deep" water deposition resulting from rapid transgression. The following slow regression culminated with the deposition of the Skoki Formation followed by a hiatus shown by lack of part of the Middle Ordovician according to Norford (pers. comm.). A new rapid transgression established conditions for deposition of the Beaverfoot Formation with a minor regression postulated near the end of this deposition (Fig. 1).

The top of the Ordovician succession is marked by the sub-Devonian unconformity. During this time some of the Upper Ordovician was eroded.

The very sandy Devonian sequence was deposited in a nearshore, predominantly tidal flat environment during a time of stable sea-level.

Next field season a reconnaissance of Ordovician geology will be made from the Pine Pass area southward to the vicinity of Jasper Park. Special consideration will be given to Ordovician outcrops with greater development of shale.

---

<sup>1</sup> Slind, O. L. and Perkins, G. D.: Lower Paleozoic and Proterozoic sediments of the Rocky Mountains between Jasper, Alberta and Pine River, British Columbia; Bull. Can. Petrol. Geol., vol. 14, pp. 442-468 (1966).

<sup>2</sup> Norford, B. S.: Ordovician and Silurian stratigraphy of the southern Rocky Mountains; Geol. Surv. Can., Bull. 176, pp. 1-90 (1969).

---

33. CRETACEOUS AND TERTIARY STRATIGRAPHY,  
CARIBOU HILLS, DISTRICT OF MACKENZIE - A CORRECTION

Project 690020

C. J. Yorath

107b

In a short note published in January 1970, C. J. Yorath and W. S. Hopkins<sup>1</sup> indicated that the Tertiary Reindeer Formation of the Caribou Hills rested on the "Bentonitic Zone", a Lower Cretaceous unit that occurs on Kugaluk, Anderson and Horton Rivers to the east<sup>2</sup>. Preliminary pollen and dinoflagellate studies by W. S. Hopkins and R. L. Cox indicate that this correlation is in error and that the underlying black, plastic, concretionary shales are Upper Cretaceous (post-Turonian) in age (R. L. Cox, pers. comm.).

---

<sup>1</sup> Yorath, C. S. and Hopkins, W. S.: Cretaceous and Tertiary stratigraphy, Caribou Hills, District of MacKenzie, in Report of Activities, April to October, 1969; Geol. Surv. Can., Paper 70-1, Pt. A, p. 245 (1970).

<sup>2</sup> Yorath, C. J., Balkwill, H. R. and Klassen, R. W.: Geology of the eastern part of the northern Interior and Arctic Coastal Plains, Northwest Territories; Geol. Surv. Can., Paper 68-27 (1969).

---



GENERAL

34. REGIONALIZATION OF CRUSTAL STRESSES  
IN CANADA: ASSESSMENT OF TECHNIQUES

Project 690033

G. H. Eisbacher

H. U. Bielenstein (Mines Branch) and G. H. Eisbacher<sup>1, 2</sup> proposed that the high horizontal in situ rock stresses near Elliot Lake could represent remanent tectonic stress components. The elastic strains were probably locked into competent units of the Huronian sequence during the Hudsonian Orogeny (about 1700 m. y. ago). It was speculated that the present easterly orientation of the maximum in situ stress axis is controlled by long-lived regional arching along an easterly trending hinge and that postorogenic joints had formed in response to these locked-in stresses.

During regional arching the stress components normal to the axis of arching are reduced below the value of stress components parallel to the axis of arching.

To test this hypothesis more measurements were carried out by H. U. Bielenstein which confirmed the close relationship between the orientation of postorogenic joints and in situ stresses. It can therefore be concluded that these joints are mechanically equivalent to experimentally produced extension fractures, with the exception that the rate of opening along the joint surfaces is probably slow.

To fit these findings into a regional framework, stress measurements made by the U. S. Bureau of Mines<sup>3, 4</sup> were plotted on a map of eastern North America. From this plot of the maximum compressional stress axes it can be speculated that long-lived slow arching during Phanerozoic time may indeed control the orientation of the in situ stress tensor near the surface of the earth's crust. The parallelism of the maximum compressional stress axes with the outline of the principal Phanerozoic depressions and uplifts is quite striking.

The knowledge of in situ stresses is pertinent to questions of mining safety, economic quarrying, stability of steep rock faces, underground fuel and gas storage, liquid radioactive waste disposal, man-induced earthquakes, and petroleum reservoir engineering.

Measurement techniques have recently been reviewed by Fairhurst<sup>5</sup>.

At present the mechanisms by which elastic strains are locked into rocks are only poorly understood. A knowledge of these mechanisms and the domain over which stresses act independently will be useful to the geomorphologist (rock slopes, sheeting, natural bridges, etc.), to the geophysicist (earthquakes and seismic wave propagation), to the structural geologist (kinematic interpretation of joints), and to the rock mechanics engineer (rock breakage, drilling and blasting, fracturing of wells).

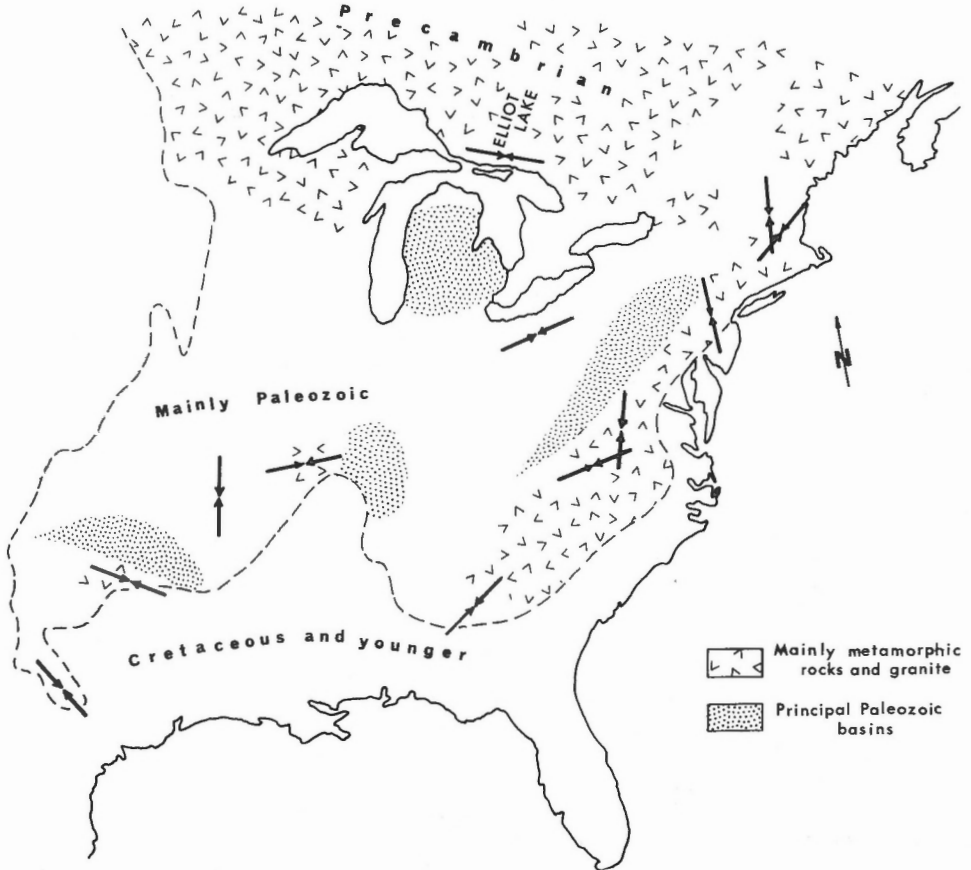

Figure 1. Orientation of maximum horizontal *in situ* stress (arrows) from measurements made in eastern North America<sup>1, 3, 4</sup>.

- <sup>1</sup> Bielenstein, H.U. and Eisbacher, G.H.: Tectonic interpretation of elastic-strain-recovery measurements at Elliot Lake; Mines Br. Research Rept. 210 (1970).
- <sup>2</sup> Eisbacher, G.H. and Bielenstein, H.U.: Tectonics and remanent elastic rock strains; *Eos*, vol. 50, p. 643 (1969).
- <sup>3</sup> Obert, L.: In situ determinations of stress in rock; *Mining Engineering*, pp. 51-58 (1962).
- <sup>4</sup> Hooker, V.E. and Johnson, C.F.: Near-surface horizontal stresses including the effects of rock anisotropy; U.S. Bureau of Mines, Report of Investigations 7224, 29 pp. (1969).
- <sup>5</sup> Fairhurst, C.: Methods of determining in-situ rock stresses at great depths; Tech. Report 1-68, Missouri River Div., Corps. of Engineers, Omaha, Neb., 115 pp. (1968).

EXPLORATION GEOPHYSICS

35. A HAMMER SEISMIC SURVEY OF AN ESKER NORTH OF  
PETERBOROUGH, ONTARIO, 31 D/8

Project 680037

R. M. Gagne and George D. Hobson

Seismic data at 72 locations in an area surrounding a well-defined esker ridge, north of Peterborough, Ontario, was collected in order to define the underlying bedrock topography and describe overburden materials (Fig. 1). The project was suggested by Dr. I. Banerjee to assist in his study of the sedimentology of the esker.

A portable seismograph, Huntec model FS-3, was used to record all seismic data. Energy source was a 16-pound sledge hammer striking a steel plate on the ground.

The esker ridge described by Banerjee<sup>1</sup> is confined to the Peterborough drumlin field which extends over much of south-central Ontario. The esker ridge under study varies in width along its course and shows gaps at intervals varying from 1/2 mile to 2 miles. Esker sediment is typically rudely stratified accumulations of gravel, sand and waterworn stones.

Liberty<sup>2</sup> has described the bedrock underlying the glacial drift as Paleozoic of Ordovician age, and composed of fine-grained limestone interbedded with calcareous shale.

The histogram of observed velocities versus frequency of occurrence, (Fig. 2) indicates four possible ranges of apparent velocities. In summary, the following table correlates velocity with suggested overburden material:

<u>Velocity Range</u> (feet per second)	<u>Material</u>
300 - 1200	Aerated surface zone.
1200 - 6600	Sandy clay, boulders and gravel.
6800 - 9000	Till or shale(?).
> - 12000	Bedrock.

Well data was obtained from Ontario Water Resources Commission publications on groundwater in Ontario. Five boreholes close to the esker ridge are shown on Figure 1 as a, b, c, d, and e. Their logs follow:

Borehole a: 0-2 feet, top soil, 2-18 feet, brown clay and gravel, 18-40 feet, very fine sand, 40-47 feet, blue clay, 47-65 feet, dark limestone.

Borehole b: Dug well to 20 feet, 20-24 feet, gravel, 24-90 feet, limestone.

Borehole c: 0-1 foot, top soil, 1-23 feet, brown clay and boulders, 23-24 feet, sandy gravel, 24-65 feet, grey limestone.

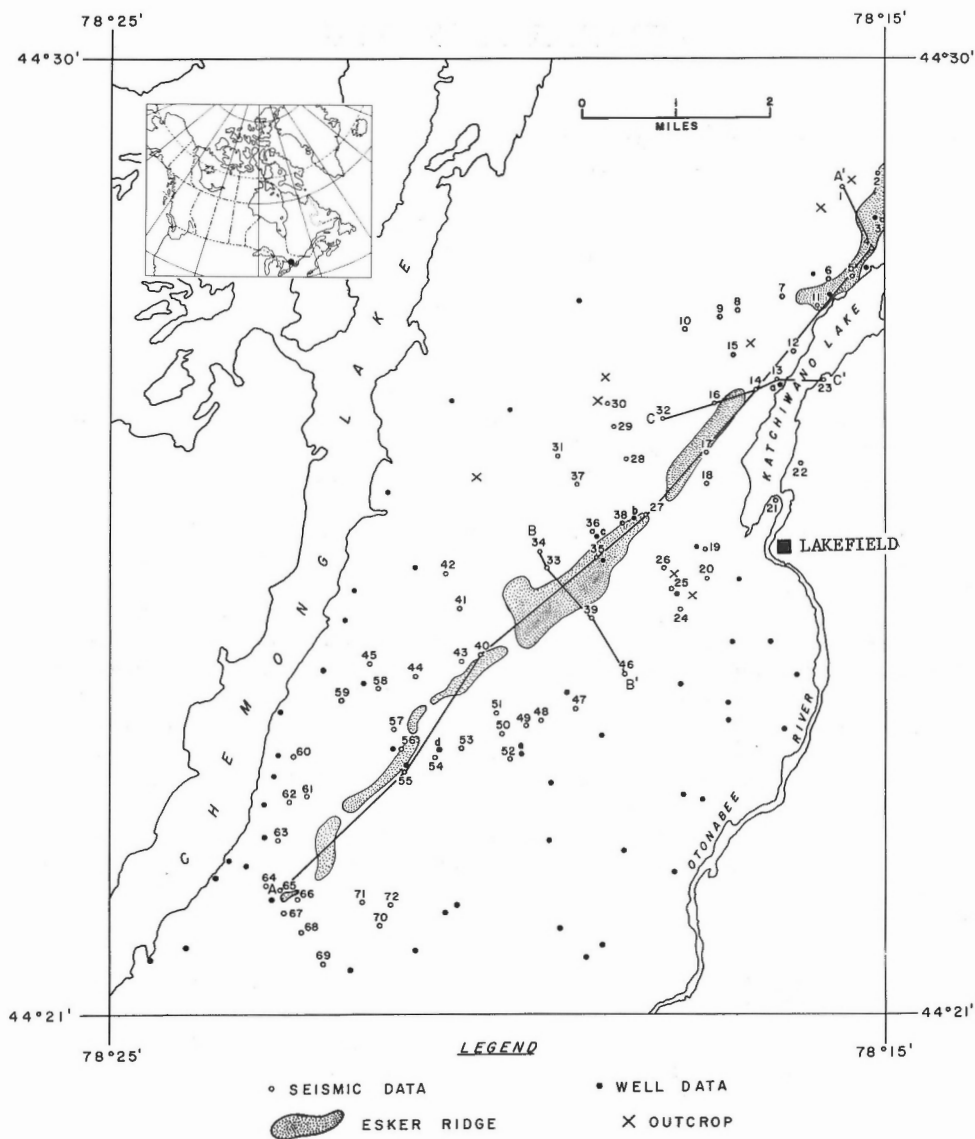

Figure 1. Location of seismic control, Peterborough area, Ontario.

Borehole d: 0-1 foot, top soil, 1-62 feet, clay hardpan, 62-120 feet, limestone.

Borehole e: 0-8 feet, brown clay and boulders, 8-20 feet, grey clay, 20-25 feet, shale, 25-120 feet, grey limestone.

Cross sections were prepared using data obtained from both borehole and seismic data. Section A to A<sup>1</sup>, Figure 3, illustrates a longitudinal

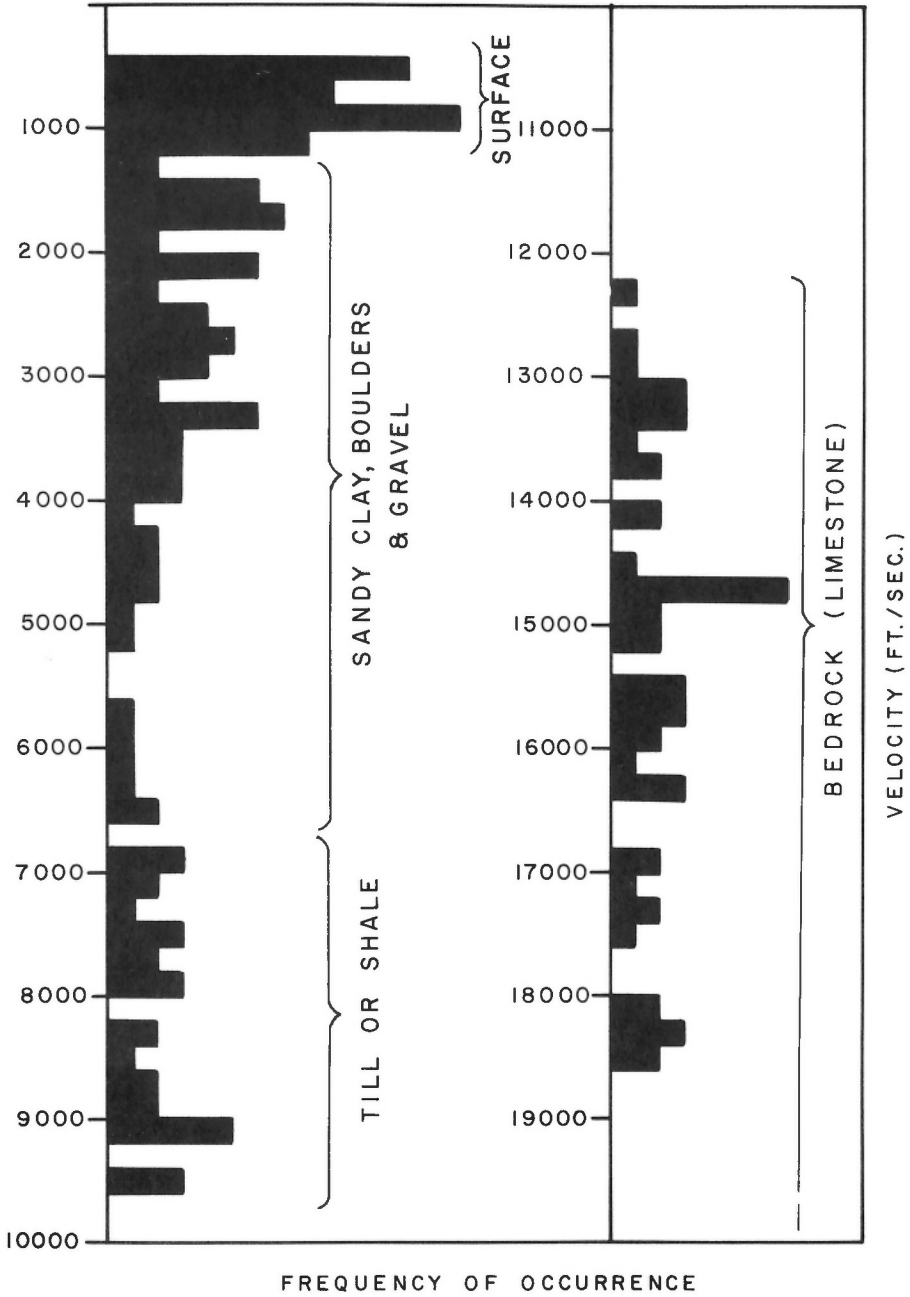

Figure 2. Histogram of observed velocities versus frequency of occurrence, Peterborough area.

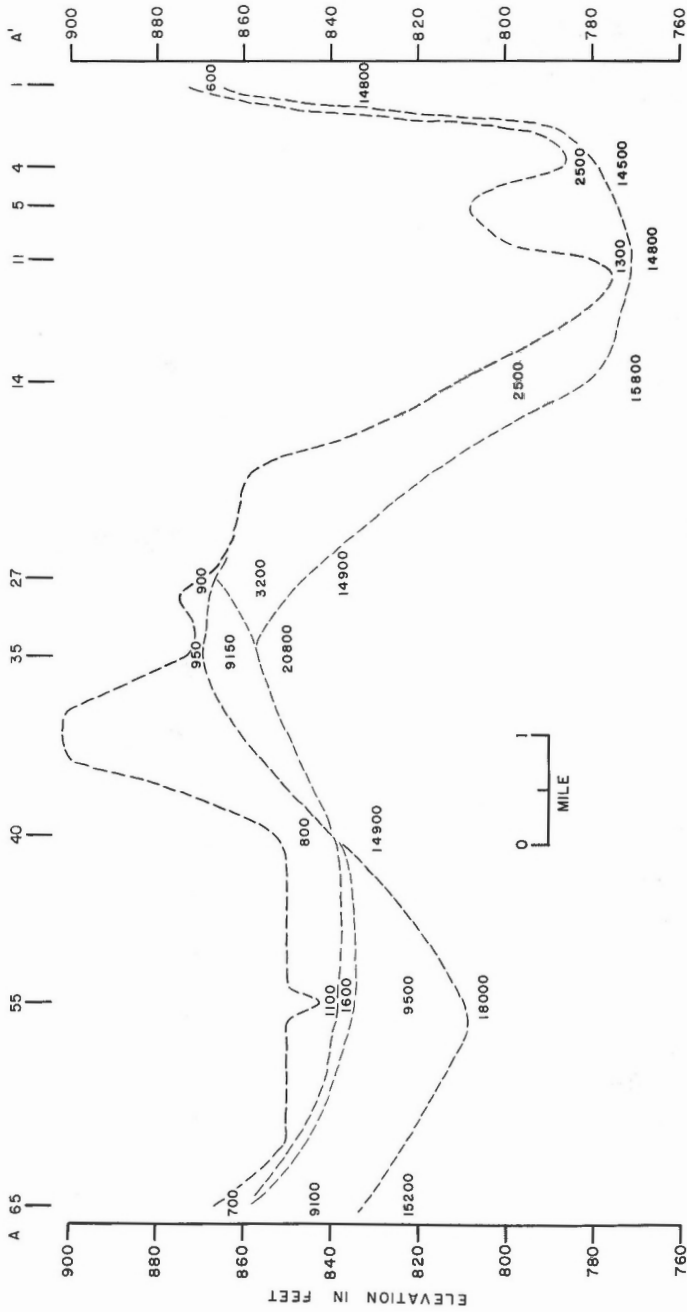

Figure 3. Section A to A', Peterborough area.

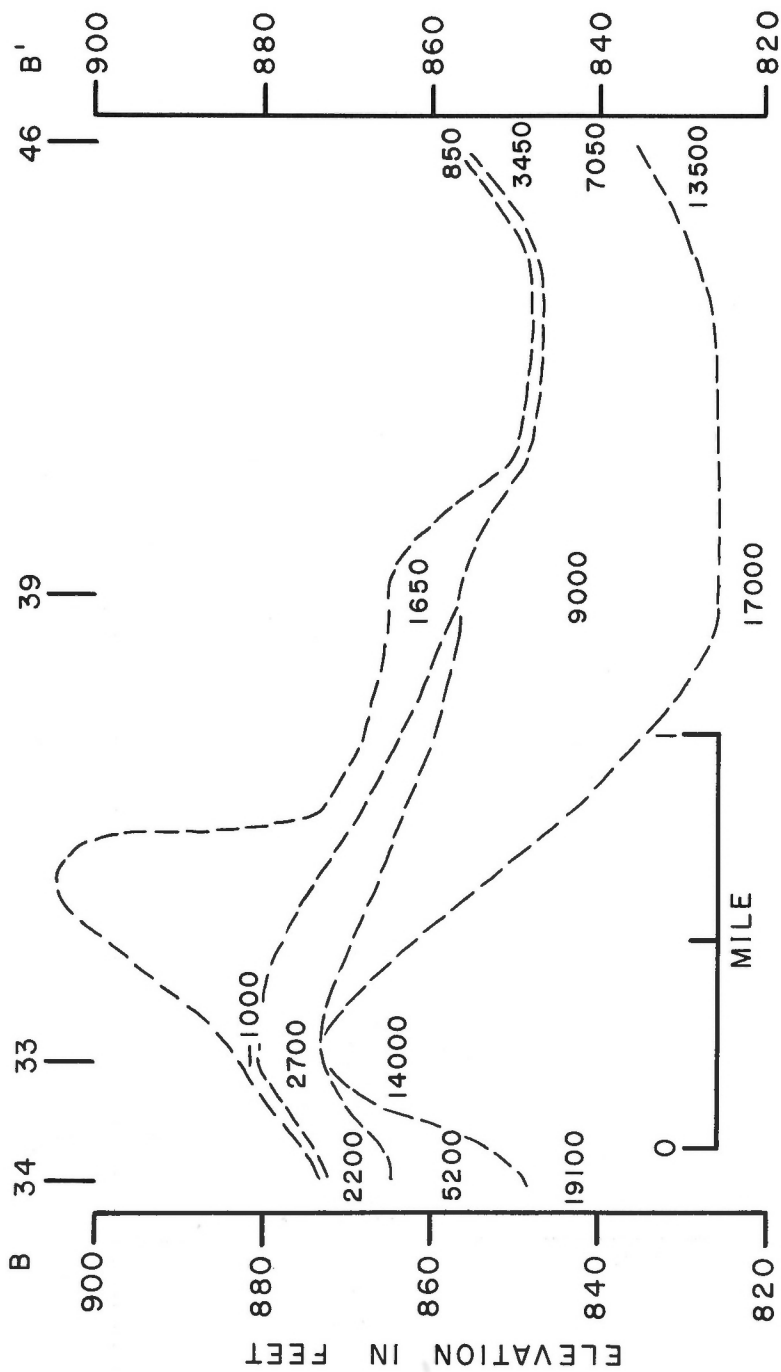

Figure 4. Section B to B', Peterborough area.

section of the esker. The recorded seismic velocities are shown on all sections, Figures 3, 4 and 5. The layer underlying the southwestern portion of the esker with intermediate velocity of 7,000 to 9,000 feet per second, indicates the presence of either a shale layer or a compacted till. The existence of a shale layer in borehole e, approximately 1 mile east of seismic location 55, indicates that a shale layer may overlie the limestone formation of bedrock. The limestone bedrock has been described by Liberty as being thinly interbedded with shale. The velocity range observed by the seismic method for either a till or a shale can be in the 6,000 to 9,000 feet per second range. Figures 4 and 5 are sections which transverse the esker. The esker appears to overlie a bedrock high in the southern section while being slightly displaced from a bedrock high in the northern section. A contour map of the bedrock surface, Figure 6, is based on seismic and borehole bedrock data and minimum values from boreholes that do not penetrate bedrock.

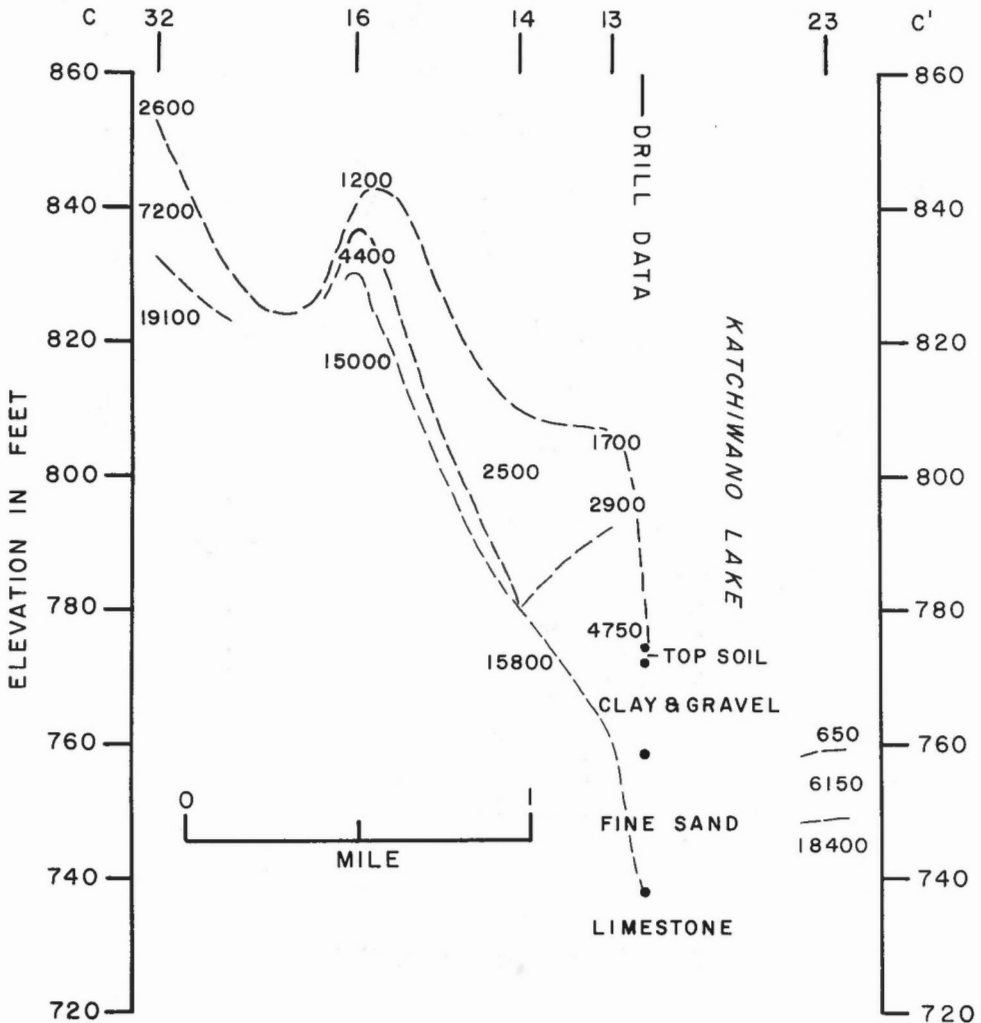

Figure 5. Section C to C<sup>1</sup>, Peterborough area.



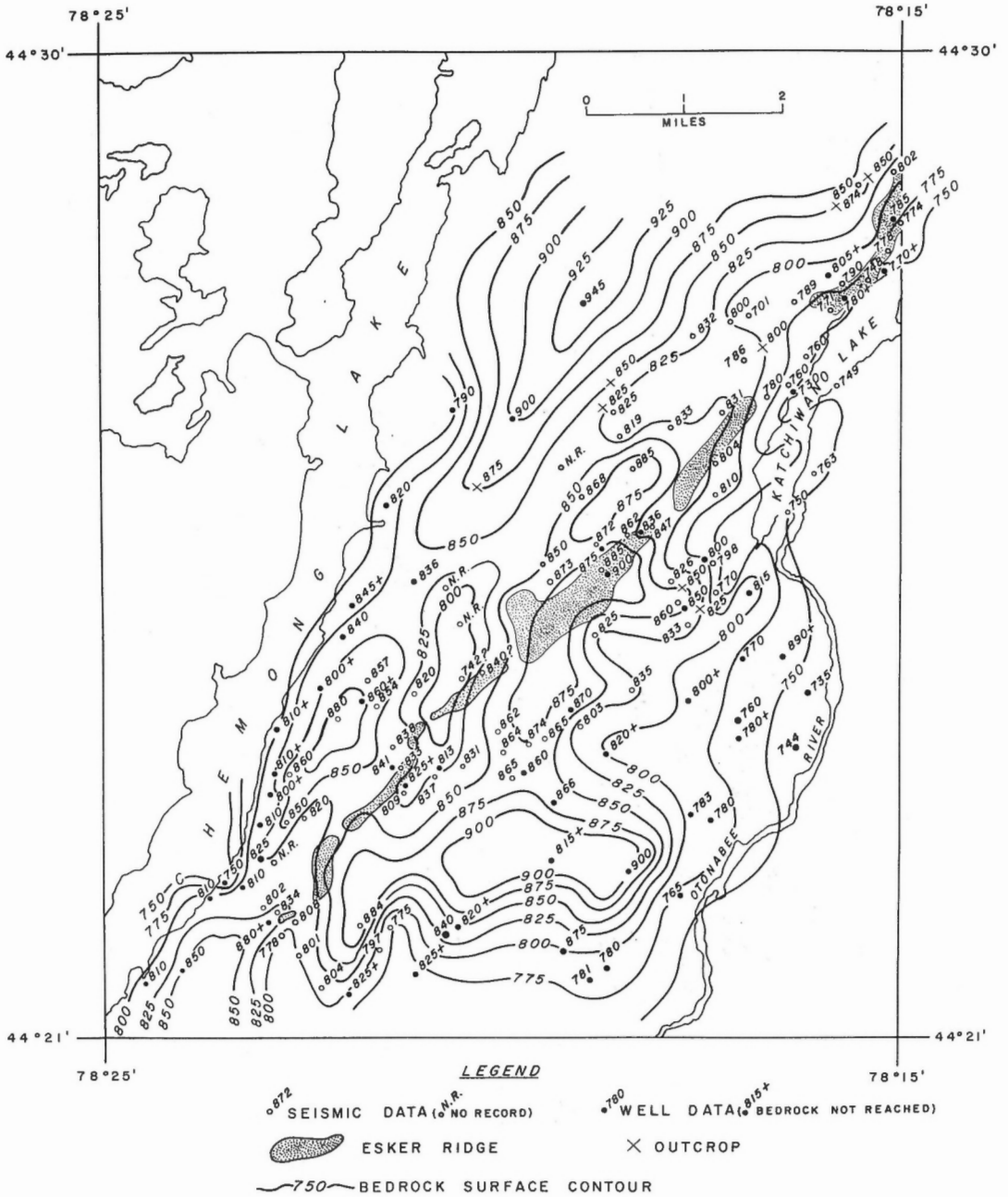

Figure 6. Bedrock topography, Peterborough area.

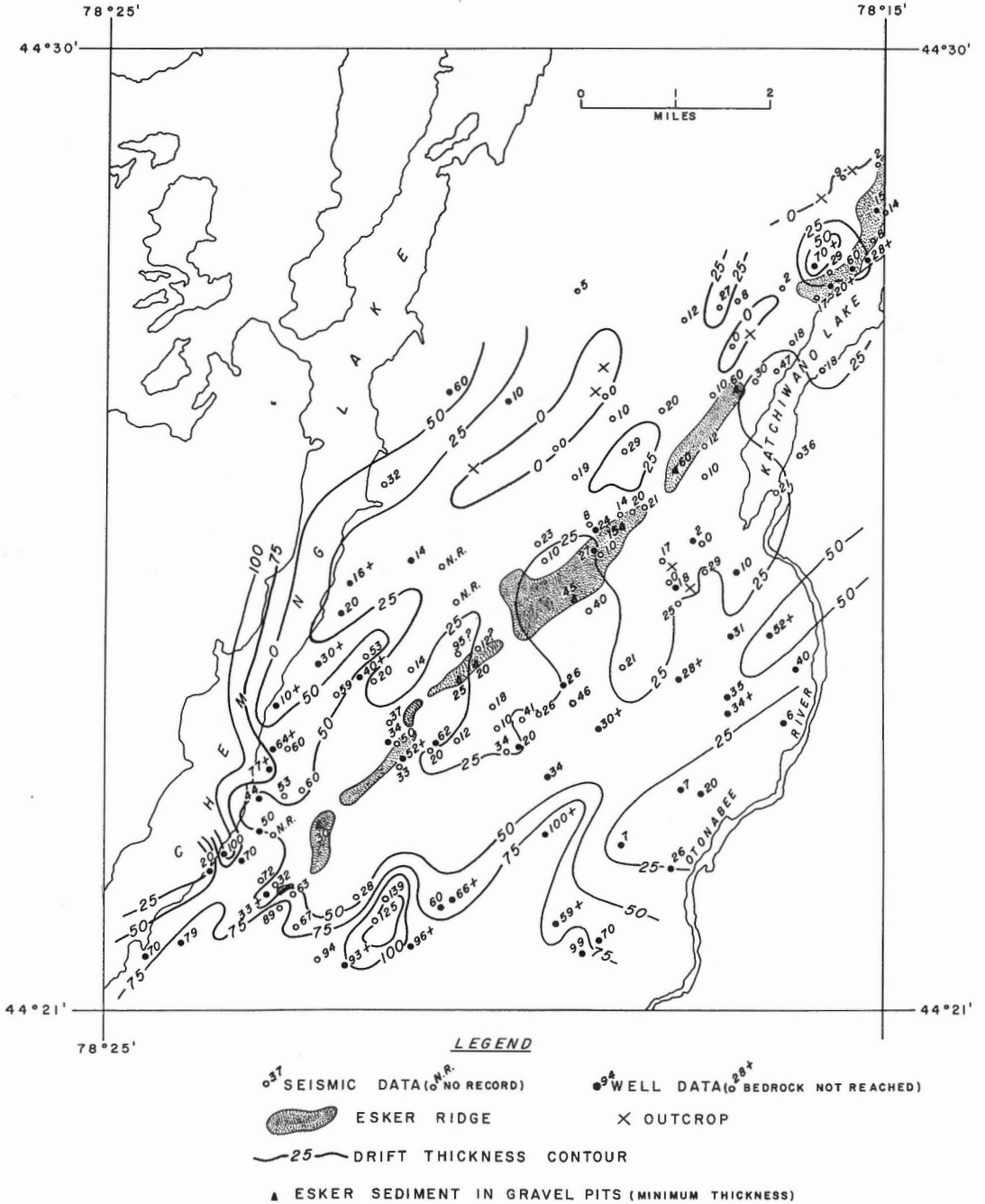

Figure 7. Thickness of overburden, Peterborough area.

Figure 7 is an isopach of overburden in the general area. The esker ridge has on the average 25 feet of total sediment overlying the bedrock surface.

In conclusion, the seismic investigation of the Peterborough esker reveals that the thickness of the esker varies from a minimum of 10 feet to a maximum of 60 feet. Sixty feet of drift was measured by Banerjee in a gravel pit west of the south end of Katchiwano Lake without reaching the bedrock surface (pers. comm.).

The apparent velocities indicate that either a till or shale layer overlies the limestone formation at the southern end of the esker. The bedrock surface highs appear to lie directly beneath or slightly displaced from the present expression of the esker ridge.

- 
- <sup>1</sup> Banerjee, I.: Sedimentology of an esker north of Peterborough, Ontario, in Report of Activities, Part B, November 1968 to March 1969; Geol. Surv. Can., Paper 69-1, Pt. B, pp. 61-62 (1969).
  - <sup>2</sup> Gravenor, C. P.: Surficial geology of the Lindsay-Peterborough area, Ontario, Victoria, Peterborough, Durham, and Northumberland Counties, Ontario; Geol. Surv. Can., Mem. 288 (1957).
  - <sup>3</sup> Liberty, B. A.: Preliminary map, Lindsay, Victoria, Durham, Ontario and Peterborough Counties, Ontario; Geol. Surv. Can., Paper 52-33 (1952).
-

