



National
Defence

Défense
nationale

Maritime Engineering Journal

40th Anniversary of
Canada's Naval Technical Forum



Summer 2022

Featured Content

**Fleet Upkeep: The RCN's Fleet Maintenance
Facilities continue to get the job done!**



Canada



The *Maritime Engineering Journal* salutes the 80th anniversary of the Women's Royal Canadian Naval Service (Wrens) with a look back at a special 2015 Naval Technical mentorship event featuring Wren veteran **Elsa Lessard**.

See "Déjà vu!" on page 20.

Read more about the history of the Women's Royal Canadian Naval Service at:
<https://www.canada.ca/en/departement-national-defence/maple-leaf/rcn/2022/04/wrcns-essential-boa.html>



**Director General Maritime
Equipment Program
Management**

Rear-Admiral Lou Carosielli, CD

Senior Editor

Capt(N) Andrew Monteiro, CD
Chief of Staff MEPM

NCM Editorial Advisors

CPO1 Martin Cashin
DGMEPM Unit Chief

CPO1 Andrew Moulton
DNPS 3, DGMEPM

Project Manager

LCdr Samuel Poulin

Production Editor/Enquiries

Brian McCullough
MEJ.Submissions@gmail.com

Graphic Design

and Production Services
d2k Graphic Design & Web
www.d2k.ca
Tel. (819) 771-5710

**Maritime Engineering Journal
on Canada.ca:**

<https://www.canada.ca/en/department-national-defence/corporate/reports-publications/maritime-engineering-journal.html>

**Our complete back catalogue
is maintained at:**

<https://publications.gc.ca/site/eng/9.507873/publication.html>

... and by the

**Canadian Naval Technical
History Association at:**

<http://www.cntha.ca/publications/m-e-j/>

Maritime Engineering Journal



(Established 1982)
Summer 2022

Commodore's Corner

Handing over the watch

by Rear-Admiral Lou Carosielli, CD..... 2

Forum

Meet the new DGMEPM Unit Chief — CPO1 Martin Cashin, MMM, CD..... 3

Correspondence:

Letter from Cmdre (Ret'd) Dennis Reilley / Passing of Cmdre (Ret'd) John Gruber 5

A Career in the Name of Service

by Cmdre (Ret'd) Marcel Hallé..... 6

NTO Spirit Award..... 7

Feature Articles

Fleet Maintenance Facilities at Work:

HMCS *Halifax* Hull Insert Repair

by Jeff Wilton..... 8

HMCS *Vancouver* Gas Turbine Engine Replacement

courtesy Ashley Evans, FMF Cape Breton 11

Real-time Multiple-Input / Multiple-Output (MIMO) Radar using
Software Defined Radio

by Cdr Robert T. Gilpin 13

Déjà vu!..... 20

Titles of Interest..... 22

CNTHA News

Burrard Dry Dock and the Construction of Destroyer Escorts on the West Coast

by Dr. Chris Madsen 23



The Royal Canadian Navy relies on the world-class repair capabilities of the Navy's two dockyard Fleet Maintenance Facilities.

The *Maritime Engineering Journal* (ISSN 0713-0058) is a **NATO UNCLASSIFIED** publication of the Canadian Armed Forces, published by the Director General Maritime Equipment Program Management, 101 Colonel By Drive, Ottawa, Ontario, Canada, K1A 0K2. Views expressed are those of the writers and do not necessarily reflect official opinion or policy. For all enquiries, including free subscriptions, please contact: MEJ.Submissions@gmail.com.

To request a **free subscription**, **change a delivery address**, or **cancel a subscription**, please contact: MEJ.Submissions@gmail.com.

COMMODORE'S CORNER

Handing over the watch

By Rear-Admiral Lou Carosielli, CD

As many of you are probably aware, I have been promoted, and am moving on this summer to take over as Chief of Staff to the Assistant Deputy Minister (Information Management) here in Ottawa. This will therefore be my last Commodore's Corner as DGMEPM before turning the watch over to incoming director-general, **Commodore Keith Coffen**.

In closing out my two years as Chief Engineer of the Royal Canadian Navy, I want to first pass on my heartfelt gratitude to all members of the Defence team, as well as to our industry partners, who have helped support the operations of the naval fleet during my term in this post. Some of what we have faced together might well be considered "once-in-a-career," if not "once-in-a-lifetime" challenges — a global pandemic, a war in Ukraine, and a battered supply chain on the negative side; but on the positive side, the delivery into service of a versatile new class of Arctic- and offshore-capable ship, starting with HMCS *Harry DeWolf* in 2020, *Margaret Brooke* in 2021, and *Max Bernays* later this year, along with the construction of two much-anticipated Joint Support Ships, the advancement of the Canadian Surface Combatant project, and the start of discussions on the eventual replacement of the *Victoria*-class submarines.

It truly does feel as if we are managing a full spectrum of engineering activity. While it would be nice to say that I am leaving all the bows nicely tied for Cmdre Coffen, could this ever be the case with a navy undergoing such a momentous period of transition as ours? The sustainment of the *Halifax*-class frigates alone will require inspiration and perspiration in equal measure to ensure that a surface combatant capability remains available to the Government of Canada over the next several years. As you can see from our cover feature in this issue, our world-class Fleet Maintenance Facilities know how to get the job done where major ship repair work is required, but it is of paramount importance that we maintain enough qualified and experienced people across the enterprise to ensure that the Royal Canadian Navy can always deploy on operations around the world safely and without hesitation.

Going forward, it is imperative that all of us strive harder to foster a healthy workplace culture that both recognizes



and celebrates the "value added" in attracting *and retaining* shipmates and co-workers who will bring their own special perspectives and talents to the table. Rolling out a focused and respectful workforce that embodies diversity, inclusiveness and innovative thinking is what will continue to expand our capabilities by attracting the best people to the important work we do for the RCN and Canada, as well as for ourselves and our families.

This issue of the *Journal* may be my last on the writing side for now, but as a loyal reader I will continue to keep tabs on the issues and activities that remain so near and dear to my naval engineer's heart. I hope that I have the chance to cross paths again soon with the people of this naval technical community who have been such a large part of my life over the last three decades. Until then, I wish you fair winds and following seas.

Lou



FORUM

Meet the new DGMEPM Unit Chief — CPO1 Martin Cashin, MMM, CD

Chief Petty Officer 1st Class Martin Cashin spent his childhood in St. John's, Newfoundland and Labrador where he completed public school at St. Bonaventure's College and Gonzaga High School, and attended a year of general studies at Memorial University.

From the age of 14, he participated in the Cadet program, completing various summer courses at Canadian Forces Bases (CFBs) Gagetown, NB; Petawawa, ON; and Baden-Baden, West Germany. When he turned 19, he enrolled in the Cadet Instructor Cadre until joining the Regular Force as a Naval Electronics Technician (Communications) in 1992. After his QL3 qualification he was posted to his first ship, HMCS *Gatineau* (IRE-236). This is also when he started shooting competitively with the Formation shooting team, and with local civilian shooting associations. He also continued volunteering with one of the Halifax area Cadet Corps.

He has served in four classes of Her Majesty's Canadian Ships in either a technical capacity or as a technical supervisor/manager. During these postings, he deployed with the Standing Naval Force Atlantic and Standing Naval Force Mediterranean fleets during several NATO deployments to the Caribbean, South America, the Mediterranean and North Atlantic. While posted ashore in Halifax, he served with N6 as a telecommunication IT/IM supervisor at CFB Shearwater, and as an instructor and standards officer at the Canadian Forces Naval Engineering School Halifax.

During most of his career, CPO1 Cashin competed at the Canadian Forces Small Arms Competition and the Canadian Forces Sniper Competition, where he was selected on six occasions to represent the Canadian Armed Forces on the national Combat Shooting Team in Bisley, United Kingdom. His shooting career culminated when he won the Queen's Medal for Champion Shot (Regular Force) at the Canadian Forces Small Arms competition, becoming the first and only sailor in the CAF ever to win this medal.

In 2010 he deployed to Afghanistan with the International Security Assistance Force's Joint Command, and forward deployed to the Regional Air Operations Coordination Centre (South) at Kandahar. Shortly after his arrival, he also assumed the duties of Sergeant-Major



for Regional Command South's Combined Joint Operations Centre. During this tour he was invited to participate as the only Canadian on the United States Air Force Air Expeditionary Wing senior NCO panel, where senior leaders from several coalition countries discussed their nation's professional development programs.

Shortly after his return to Canada, he was inducted into the Canadian Forces Sports Hall of Fame for his shooting achievements at the National and International levels, and for work with both the Dominion of Canada Rifle Association and the Nova Scotia Rifle Association as a competitor, coach and team-builder.

In 2012 he was posted to the National Capital Region, where he joined the project management office for the

(Continues next page...)



Halifax-class frigate modernization effort as the Combat System Integrator Training Coordinator and Directorate Chief. After a year on the Advanced Training List, he was posted to the Chief of Naval Staff where he worked as

the Statements of Operational Capability Deficiencies Manager within the Directorate of Naval Requirements, and as the RCN's Honours and Recognition Chief, and Naval Dress Secretary.

As a result of the 2019 Personal Appointment Board (PAB), he was appointed as the Divisional Chief Warrant Officer for Chief of Staff (Materiel), Director General International and Industry Programs, and Director General of Procurement Services. Shortly after this appointment, he was seconded to the Director General Professional Military Conduct for six months as part of the Heyder Beattie class action Final Settlement Agreement apology leadership team.

In June 2022, Chief Petty Officer 1st Class Cashin was appointed as the Division Chief Petty Officer for the Director General Maritime Equipment Program Management Division.

He is married to a public servant who is employed as a manager with the Canada Border Services Agency's enforcement division.



FORUM

Correspondence

Letter from Cmdre (Ret'd) Dennis Reilley*(Addressed to production editor Brian McCullough)*

Congratulations on shepherding the *Maritime Engineering Journal* during the past 40 years. In my view the *MEJ*'s success can be attributed directly to your enthusiasm, innovation, leadership, and writing style. I came up with the original spark as you mentioned in your recent article; however, it was you and Robbie who ran with it, and pushed it through, in spite of the many frustrations and hurdles.

Those were great years in the Maritime Engineering and Maintenance division (DGMEM), with other notable successes such as the digital Shipboard Integrated series of systems — i.e. SHINMACS (machinery control), SHINCOM (interior communications), and SHINPADS (processing and display) — along with fuel cell research, the launch of the Marine Engineering Technician Training Plan (METTP), and early work on “negative guidance” approaches for the Canadian Patrol Frigate program.

One thing that you and many others exemplified was that “No” was never an answer, and important lasting initiatives were pushed through by the various teams. The spirit was always “Can do,” to the benefit of the RCN and, by extension, Canada.

Kindest regards,
Dennis

**Commodore (Ret'd) John Alfred Gruber***(March 26, 1932 - May 19, 2022)*

On a related but sadder note, the *Maritime Engineering Journal* acknowledges the passing of **Cmdre (Ret'd) John Gruber** at the age of 90. As Director General Maritime Engineering and Maintenance (DGMEM) in 1985, Cmdre Gruber set the wheels in motion to ensure that the initiative of **Capt(N) Dennis Reilley** to launch this semi-professional technical branch journal three years earlier was established as a long-term undertaking by the Royal Canadian Navy's technical branch. The uninterrupted 40-year history of the *MEJ* remains the proud legacy of this much-respected officer and gentleman. The Naval Engineering Council and editorial staff of the *Journal* offer their deepest condolences to his family.

— **Capt(N) Andrew Monteiro,**
Chief of Staff MEPM, Editor

***A community at work***

Thank you, everyone, for your kind comments regarding the Journal's amazing achievement of 100 issues over 40 years of uninterrupted publication.

— **Brian McCullough,**
Production Editor

FORUM

A Career in the Name of Service

By Cmdre (Ret'd) Marcel Hallé

Less than a year into retirement after nearly 37 years of naval service, I can't help but reflect on our current security challenges and the global fight for democracy, all sharpened by what is playing out in Ukraine. Amidst the senseless and abhorrent death and destruction the world is witnessing, what has emerged is the inspirational determination of a resilient Ukrainian population, and a heightened sense of the importance of the NATO alliance and the part Canada plays in safeguarding global peace and security. While diplomacy is key in defusing tensions between nations, we must never underestimate the role of deterrence and, if need be, the requirement to defend — both of which are predicated on the availability of a robust and capable military.

As I look back, I feel honoured to have been given the opportunity to work alongside so many wonderful people who were part of my own incredible journey in the service of both Canada and NATO, doing what we could to make the world a safer place. I joined the Royal Canadian Navy's submarine service as a Direct Entry Officer early in my career, and after serving as Engineering Officer on board HMCS *Ojibwa* (SSK-72), I would go on to focus almost one third of my effort in support of submarines at sea and ashore on three different continents. I feel privileged, however, to have had the benefit of a well-rounded career through a series of technical and non-technical postings that not only shaped my outlook, but developed skills that allowed me to contribute in ways I never imagined when I joined the Canadian Forces in 1985.

Over the years, I would serve in Fleet Maintenance Facility Cape Scott, in various positions with the Maritime Engineering and Maintenance division and Director General Maritime Equipment Program Management (DGMEPM), in Australia on the in-service support changes for the RAN's *Collins*-class submarines, as directing staff at the Officer Candidate School in Chilliwack, BC, as Base Commander of CFB Esquimalt on Canada's West Coast, in appointments as NATO's logistician at Supreme Headquarters Allied Powers Europe (SHAPE) in Mons, Belgium, and later as the Alliance's maritime planner in London, UK. There were other parts to this, of course, and I feel extremely fortunate to have held command positions on three separate occasions during this great journey.



"Never doubt your own value to the team, both as a learner and as a mentor..."

— Cmdre (Ret'd) Marcel Hallé

If one thing was clear throughout my career, it was that change will forever be a part of the equation. Rather than simply accept the inevitability of this, I found that looking for ways to lead and manage the direction of change offered me the best opportunities for helping Canada and NATO achieve their defence goals. Whether the change was part of the strategic organizational pivots instituted during my time at DND and NATO headquarters, dockyard facility upgrades along the Halifax waterfront, new ways of approaching fleet maintenance, helping lead business management improvements to the fleet maintenance

facilities, getting an in-service support arrangement in place for our *Victoria*-class submarines amidst court challenges, or standing up a new operational level headquarters in NATO, my team and I did our best to ensure the outcomes would be successful.

Overall, my service experience in the Canadian Armed Forces was as rewarding as it was interesting, and I took pride in wearing my uniform. While the work itself wasn't always easy, the teamwork behind it was never less than outstanding. I can honestly say there was never a time when it felt as if we were not doing our best to uphold the "can do" tradition that the Canadian defence team is known for around the world. I know that working so closely with integrated teams of military personnel, civilian public servants and industry representatives brought greater value to the enterprise as a whole, and I am grateful to the people who taught me so much. One of these was Capt(N) (Ret'd) Rick Payne. With his passing on June 5, we lost an exemplary officer who was a fine mentor, a dear colleague, and good friend to many of us.

As a former DGMEPM and Chief Engineer of the Royal Canadian Navy, I sign off wishing each and every one of you all the very best in your careers, and I look forward to staying in touch with the great work of Canada's naval

technical community through the *Maritime Engineering Journal* — a wonderful and enduring publication due in large part to Brian McCullough's steadfast leadership.

In closing, let me just say that the success of any task depends on the degree to which you and your team are able (and willing) to step up with your knowledge, innovative ideas, cooperation, and leadership. Never doubt your own value to the team, both as a learner and as a mentor, and be bold in supporting the changes necessary for keeping your tasks integral to the mission's success. Wherever your career takes you, maximize the opportunities presented to you, and learn from your experience. The example you show today will set the bar for those who follow tomorrow.

Look after yourselves and each other.



Cmdre (Ret'd) Hallé served in the Royal Canadian Navy from 1985 to 2021, and was DGMEPM (publisher of the Journal) from 2013 to 2015.

NAVAL TECHNICAL OFFICER SPIRIT AWARD



Photo by Brian McCullough

2021 NTO Spirit Award RAdm Mack Silver Plate

Lt(N) Aaron Ezekiel

For demonstrating the spirit that enables
naval technical excellence.

Presented by Cmdre Lou Carosielli



FEATURE ARTICLE



FMF Cape Scott: HMCS *Halifax* (FFH-330) Hull Insert Repair

By Jeff Wilton

(Adapted for the *Journal* courtesy of *The Great Scott Times* newsletter of Fleet Maintenance Facility Cape Scott, Halifax, NS.)

As the Royal Canadian Navy continues to manage the upkeep of its main surface combatant fleet of *Halifax*-class frigates, it relies on the world-class repair and overhaul capabilities of the Navy's two dockyard Fleet Maintenance Facilities — FMF Cape Scott in Halifax, NS, and FMF Cape Breton in Esquimalt, BC. The FMFs work closely with shipboard and shore-based technical authorities to identify operational deficiencies for repair, and ensure nothing is missed. Here are two recent examples of just some of the work they do.

Prior to Christmas 2021 during HMCS *Halifax*'s short work period at Fleet Maintenance Facility Cape Scott (FMFCS), several areas of concern were noted along the exterior of the frigate's port-side hull plating between bulkhead frames 0 and 2.5 (Figure 1). Corrosion was found in the plating below the foc'sle, at the mezzanine deck level, in the area of the rope stores and bosun's workshop to a degree previously unknown at this location. The cause was traced to a leaking weather cap on the upper deck where the jackstaff light electrical cord deck penetrates the foc'sle, which allowed an ingress of corrosive seawater. The greatest concern was how far the corrosion had progressed, and what level of wastage was present in the plating, longitudinals, frames and adjacent steel deck structure. Depending on the extent of the damage, there was risk of a hull breach should the ship encounter heavy seas.

To allow a proper assessment, the paint, coverings and interior insulation lagging were removed to expose the structure to bare metal. Hull surveyors then conducted a structural inspection on the interior of the port-side hull plating as far forward as general store no. 1. The area of hull plate surveyed was within the shear strake, and is considered critical structure, with a maximum allowable wastage of less than 15 percent in accordance with the Requirements for the Survey and Repair of Steel Ships (C-03-015-003/AM-001), a technical document used for determining when steel must be replaced due to corrosion.

The survey determined that the shell plating was holed in four areas, and eroded beyond the allowable tolerance. New hull inserts would be required. The webs on some of the longitudinals were also found to be wasted and holed along the same sections (Figure 2), and would have to be



Figure 1. Area of corroded steelwork on the port side of the foc'sle mezzanine deck.



Figure 2. Holed and wasted sections of longitudinal.

repaired. The renewal of these sections of steel longitudinal tees, and the eroded deckhead plating around the foc'sle electrical deck penetration, meant that a weld metal build-up repair procedure would likely be required.

The extent of the repairs would require tradespersons to work on both the inside and outside of the ship. Performing steel repairs in Nova Scotia between January and March is always a challenge, so the ship was berthed in the camber at



Figure 3. Support structure for the hanging work scaffold.



Figure 4. Rather than attempt to salvage short sections of longitudinal, complete sections of shell plating and longitudinal were cut away.

Jetty NF 2/3, with the port side of the bow facing the adjacent building in an effort to shelter the work area as much as possible. Since it was not practical to perform the exterior work from lifts, a hanging scaffold would have to be constructed and hoarded (enclosed) against the weather (Front Cover and Figure 3). As the FMF shipwright shop was overloaded with other priority work, outside contractors were brought in to construct the hanging scaffold, which requires an extraordinary skillset to ensure the structure is secure. This was critical, since FMF tradespersons would be working above the water from inside the enclosure, where they would be protected from East Coast winter wind and weather conditions.

The repairs began as tensions were rising in Ukraine, and as Nova Scotia was being hit hard with another wave of COVID-19. Uncertain as to how this might affect the FMF Cape Scott workforce that was now on a two-shift rotation, plate shop supervisor Joe Whalen took the lead in organizing the *Halifax* repair work for the two shifts, coordinating activities between the different shops and the project leaders. To ensure the repair progressed in the most efficient manner, he recommended cutting out complete sections of plate and longitudinal (Figure 4), rather than attempting to salvage short sections of longitudinal. This would mean cutting and fitting longer sections of steel, but it also meant not having to cut away the attachment welds between the shell plating and frames, then grinding the edges of the frames in preparation for welding on the new plating. The decision to install completely new longitudinals saved significant preparation work and many hours of labour. This change in approach to the repair, combined with two work shifts, proved vital in shortening the duration of the repair.

(Continues next page...)

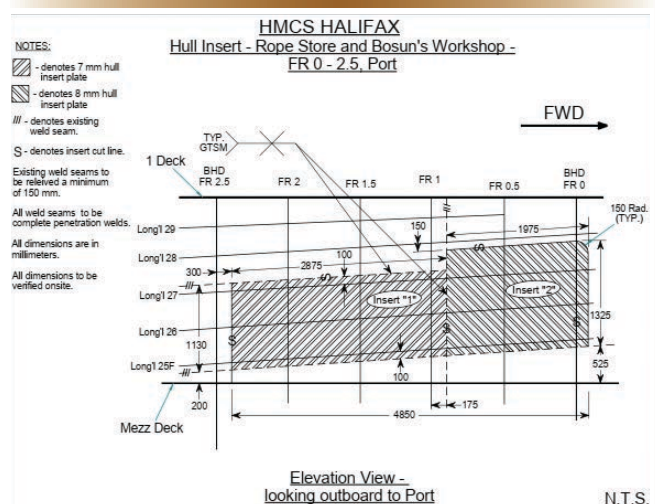
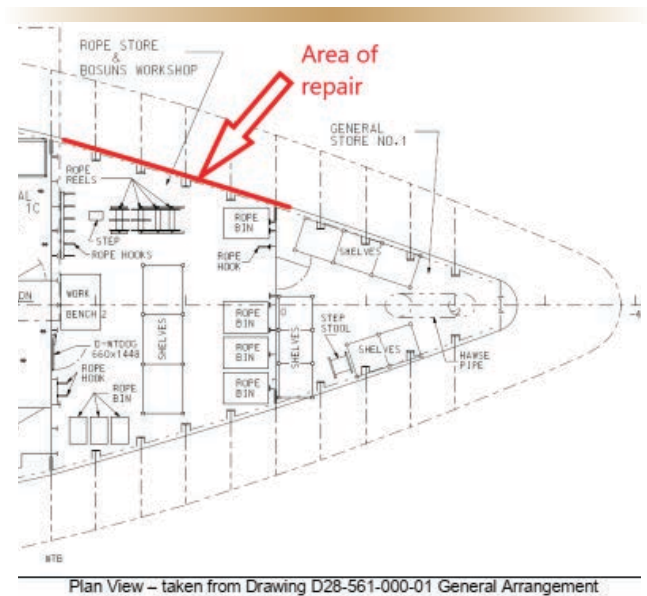

Figure 5. Schematics showing the placement of the two hull inserts.

Within eight days, the plate and welding shops had the shell plating and longitudinals cut out, and the edges of the solid remaining steel ground, beveled, and ready for templating the new pieces. The first step was to cut, fit, and weld in the new longitudinals. The hull survey directed that the insert should be fabricated and installed in two sections (Figure 5). This would allow for easier handling of the new plate inserts, as they had to be brought in through the side of the hanging scaffolding with a crane before being pulled into place with the use of chain blocks by the riggers. The plates could then be dogged and wedged tightly to the longitudinals and frames (Figure 6) before being fully welded. Upon completion of the welding, a visual inspection was conducted on all welds, followed by magnetic particle inspection. Portions of the welds at the highest stress points were then X-rayed, with no weld failures evident.

The removal of the original shell plating and longitudinals began on Jan. 20, 2022, with all steel removed and new inserts welded in and ready for X-raying on Feb. 1.

The replacement of the steel was only one aspect of the repair, of course, as a job like this required significant support from other FMF Cape Scott trades shops to first prepare and then later reassemble the compartment. In all, the HMCS *Halifax* insert repairs involved 11 shops and 1,907 hours of labour, along with the incorporated services of the FMFCS contracts section to have the hanging scaffolding constructed. The project ran extremely well, thanks to the leadership of the supervisors, great teamwork between the shops, and excellent contractor support.



Jeff Wilton is the Work Centre Manager for Production Hull (Plate/Weld Shops) at Fleet Maintenance Facility Cape Scott, Maritime Forces Atlantic, Halifax, Nova Scotia.

Figure 6. FMF tradespersons dogged the new plate inserts and wedged them tightly to the longitudinals and frames for final welding.



FEATURE ARTICLE



FMF Cape Breton: HMCS *Vancouver* (FFH-331) Gas Turbine Engine Replacement

(Courtesy Fleet Maintenance Facility Cape Breton, Esquimalt, BC, with files from FMF Strategic Communications Officer Ashley Evans.)

The *Halifax*-class frigates operate two 17.7-MW General Electric LM2500 gas-turbine (GT) engines as main propulsion prime movers. These powerful engines, which are widely used by navies around the world, normally operate through a flexible CODOG (combined diesel or gas) cross-connect arrangement that includes a single 6.5-MW SEMT Pielstick diesel engine. The top speed of these ships is in excess of 30 knots.

Earlier this year, marine technicians aboard HMCS *Vancouver* observed some unusually high lube oil consumption by the ship's port GT engine. As the engineering officer of the watch (EOOW) continued to monitor the machinery's performance, it became clear that whenever the engine was operating at speeds below 10 knots, the consumption of lube oil (drawn from B sump) would rise above allowable limits, due in part to a lack of sump pressurization air at low speed.

With the ship gearing up to participate in Exercise RIMPAC 2022 (June 29 to August 4), before moving on to Op Projection in the fall as part of Canada's ongoing commitment to global peace, an operational deficiency (OPDEF) report was raised in DRMIS, the Defence Resource Management Information System. The Navy had a serious time crunch on its hands, but it also had a valuable strategic asset in its inventory on the West Coast — Fleet Maintenance Facility Cape Breton (FMFCB). Prepared for just such an eventuality, the FMF's crack teams of subject matter experts swung into action to order a replacement unit for *Vancouver's* ailing port GT engine from the original equipment manufacturer (OEM), and prepare the ship for the change-out. In mid-March, a new gas-turbine engine was delivered to FMFCB, accompanied by factory service representatives from GE Canada.

As the replacement engine was prepped for installation, and the faulty engine was prepared for removal, FMFCB's Shop 133 Mechanical Fitters team got to work installing guide-rails leading down into the ship's forward engine room three decks below. The old engine would have to be

(Continues next page...)



Photo by SLt Wilson Ho, MARRPAC Public Affairs.



Photo courtesy HMCS Vancouver.

Tradespersons from FMF Cape Breton lower a replacement gas-turbine engine into HMCS *Vancouver's* forward engine room.



mounted onto a carrier, which would then be attached to the guide rails inside the uptakes for the slow hoist up and out of the ship. The replacement engine would then be attached to the carrier for the reverse trip down into the space, where it would be seated and connected to the propulsion system.

The risk of damage to a high-performance engine during an operation like this can be high, but the FMFCB riggers and other tradespersons from 12 shops in the Production and Engineering departments knew their business — as did the GE Canada factory service representatives — and everything went off smoothly for a successful installation. After an estimated 927 hours of work, HMCS *Vancouver* was back in service, operating two healthy General Electric LM2500 propulsion gas-turbine engines in time to meet the ship's operational commitments. It was a great job done by everyone.

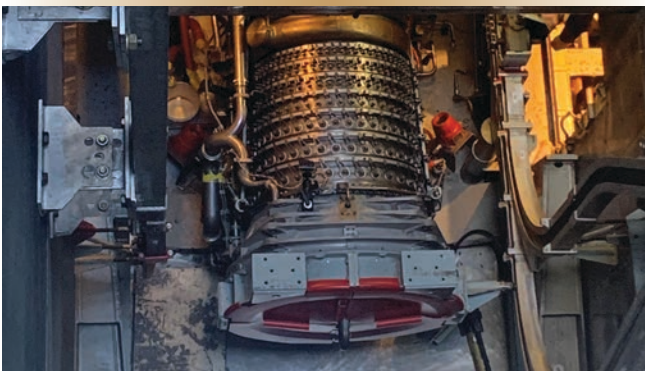

Photos by Ashley Evans

FEATURE ARTICLE

Real-time Multiple-Input / Multiple-Output (MIMO) Radar using Software Defined Radio

By Cdr Robert T. Gilpin, CD, BEng, MASc, PEng

(Adapted by the author from his April 2021 Master's thesis in Applied Science in Electrical Engineering, submitted to the Department of Graduate studies at the Royal Military College of Canada, Kingston, ON.)

Radars have traditionally consisted of customized equipment that cannot be easily reconfigured or modified. Although improvements to the radiofrequency front end, such as the adoption of Active Electronically Scanned Arrays (AESA), have provided flexibility to the radar's beamforming, sector scans are often performed using conventional techniques in which a transmit beam is slowly steered through a sector to illuminate targets in a sequential manner, leaving the radar blind to threats when the transmit beam is pointed in other directions.

Recent research in the field of communications has revealed a new scanning mode, known as multiple-input / multiple-output (MIMO). MIMO can be used by an AESA to illuminate the entire field of view of the radar simultaneously, where beamforming is done in post-processing, thus providing uninterrupted situational awareness. However, the MIMO radar mode is more challenging to implement because of the added requirements of orthogonality between its channels, and because of the drastic increase in the required digital signal processing.

In this research, commercially available software-defined radios (SDRs) are used to build a 64-channel, reconfigurable AESA radar operating in C-band (NATO G-band). The SDRs are used to design and implement a three-dimensional MIMO radar. For the first time, the flexibility of the SDRs has been harnessed to evaluate the performance of three different methods of achieving the orthogonality required for MIMO by using a linear frequency modulated continuous waveform (FMCW). In addition, the radar's parameters are user-selectable, and can be rapidly changed such that the radar can be used in different environments without requiring changes to the hardware.

This article provides a brief background on radar basics and the concept of MIMO radar, and a description of the MIMO radar design. As well, a selection of results is

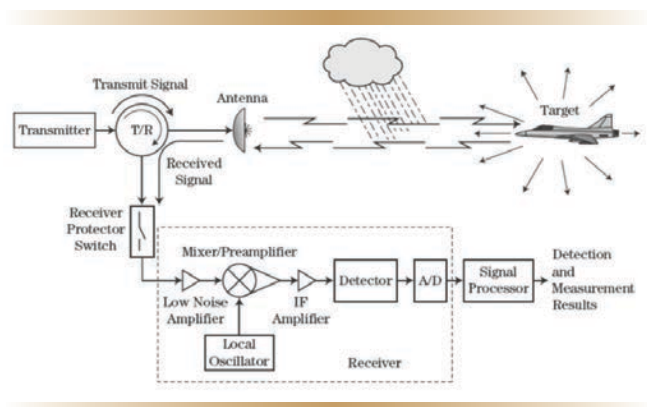

Figure 1. Basic elements of a radar.

presented to emphasize the importance of MIMO radar research, followed by potential areas for further research and a conclusion.

Background

As illustrated in Figure 1, radio detection and ranging systems (radars) detect objects by transmitting high-frequency electromagnetic (EM) waves that reflect off an object, then propagate back to the radar's antenna for processing to allow the object's (or target's) bearing, range and radial velocity to be determined.

One radar that has gained popularity due to its ability to scan a large field of view is the Phased Array Radar (PAR). To understand MIMO radar, a brief description of PARs is required. Figure 2 shows a traditional PAR known as a Passive Electronically Scanned Array (PESA). In the PESA, a single transmitter generates a high-powered signal that is transmitted through individual antenna elements. Each transmit element has an associated computer-controlled phase shifter (Φ) that creates a directional beam by adding a phase shift to the signal from each element. The narrow beam is sequentially steered through the field of view by changing the phase at each element.

(Continues next page...)

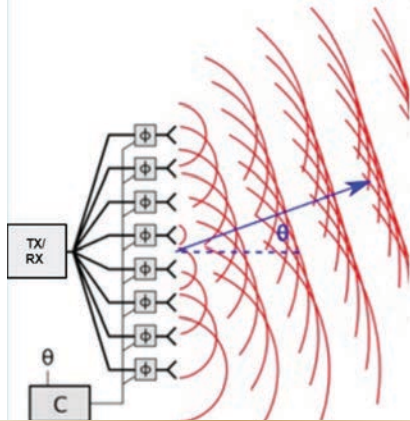

Figure 2. Passive Electronically Scanned Array where theta is the scan angle, C is the computer control, phi is a phase shifter.

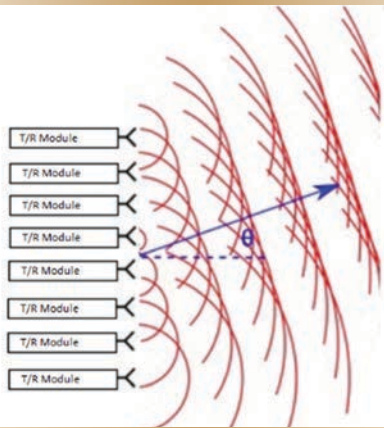

Figure 3. Active Electronically Scanned Array (AESA) radar where theta is the scan angle, and the transmit/receive (T/R) modules are individually controlled.

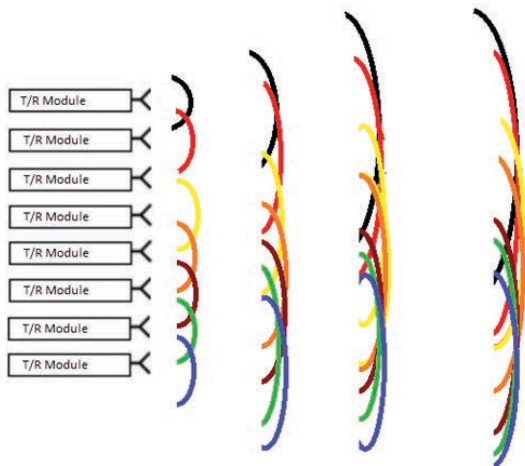

Figure 4. MIMO radar (AESA - MIMO Mode) where each colour represents an orthogonal waveform transmitted from a T/R module.

Figure 3 displays the second generation of phased array radar, the AESA radar. This is the current technology used in modern radars like the AN/SPY family of PARs. Each element of the AESA is a transmit/receive (T/R) module, which gives access to element control of the array. The AESA can create multiple beams using sub-arrays, which decreases the scan time of radar and allows the AESA to perform multiple functions at once, i.e. track while scanning with multiple beams. Multiple beams allow for faster scanning, but the radar requires time to scan the entire field of view.

Figure 4 shows an extension of the AESA known as MIMO radar. Rather than using sub-arrays within the radar to form multiple beams like the AESA, each T/R element acts independently, transmitting an orthogonal waveform. The transmit beams are wide, 180 degrees typically, and can illuminate the entire field of view with one sequence of pulses since there is no directivity on transmit. This is sometimes referred to as scan on receive.

To take advantage of MIMO technology, the receiver must be able to separate the transmitted orthogonal signals on reception. This is done using time division multiplexing (TDM), frequency division multiplexing (FDM), or code division multiplexing (CDM).

In TDM, each T/R module transmits at a specified time interval, ensuring the waveforms do not overlap. A figure representing TDM is shown in Figure 5 with an FMCW chirp as the base waveform with four T/R modules. Although easy to implement with perfect orthogonality between transmit channels, TDM is slow because each transmit element is given a place in time. This is not the case in FDM and CDM, as with these forms of multiplexing all signals are sent simultaneously.

In FDM, each of the transmitted signals is modulated by a different carrier frequency, also called a subcarrier. An example of FDM is shown in Figure 6 using an FMCW as the base waveform. As can be seen, each transmitter

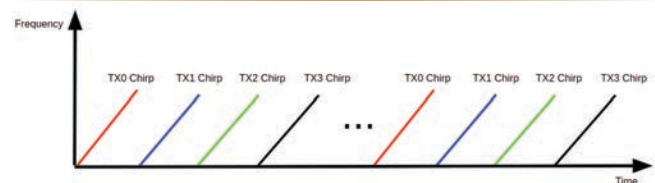

Figure 5. FMCW signal using TDM. TX indicates which T/R module is transmitting.

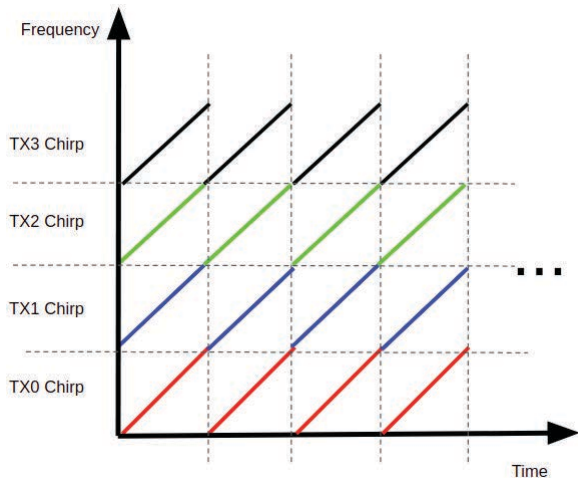

Figure 6. FMCW signal using FDM. TX indicates which T/R module is transmitting.

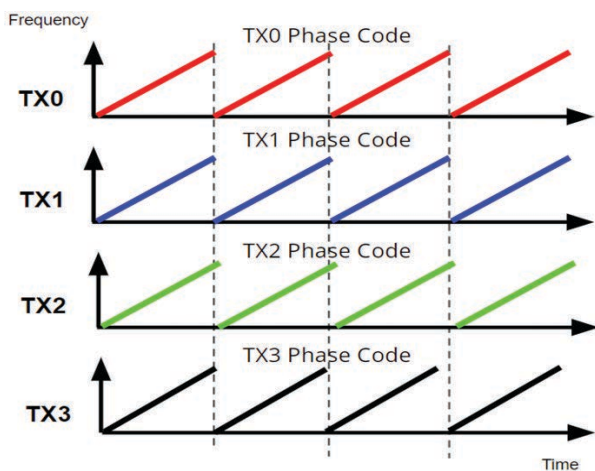

Figure 7. FMCW waveform shown with a phase code sequence indicated above the transmitted wave for each T/R module.

occupies a portion of the radar bandwidth, with all signals transmitted simultaneously.

In CDM, the waveforms are encoded by a series of orthogonal phase codes for each transmit element (Figure 7). The waveform occupies the full bandwidth of the radar transmitter and the signals are decoded in the receiver. CDM is ideal in MIMO applications because the full bandwidth can be used for each transmit element, and the signals are transmitted simultaneously.

MIMO Radar Design

With an understanding of PARs and MIMO radar theory, the next section discusses the MIMO radar design. It describes the five-phase process (Figure 8) used to design and build an AESA radar capable of MIMO modes of operation.

In phase 0, the radar performance parameters are determined for a short-range surveillance AESA-MIMO radar. To be able to test the radar in a laboratory environment, two sets of requirements are created: a lab mode and a surveillance mode, shown in Table 1.

To obtain the required performance described in Table 1, Phase 1 of the design uses radar theory to determine the required specifications of the radio frequency (RF) front and the digital signal processing (DSP) algorithm displayed in Table 2. Based on the DSP parameters and the short-range application, the FMCW waveform is selected as the base waveform.

Once the radar parameters from Phase 1 are calculated, Phase 2 of the design selects the RF and processing equipment for the radar. The cornerstone of the radar is the Ettus Research N-series (N321/N320) SDR. Each radio

(Continues next page...)

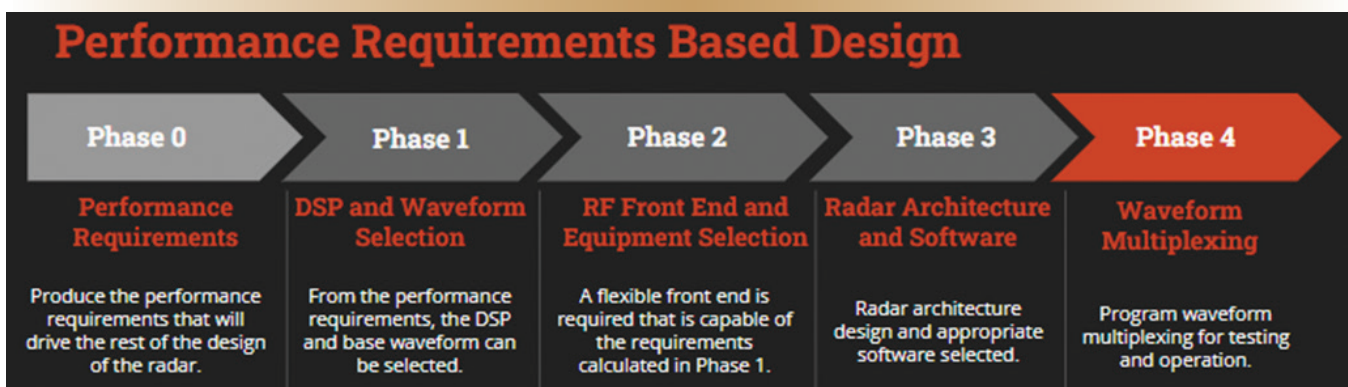

Figure 8. MIMO radar design phases.

Table 1. Radar performance requirements.

Parameter	Symbol	Unit	Surveillance Mode	Lab Mode
Maximum Range	R_{max}	m	150	50
Range Resolution	R_{res}	m	0.75	0.75
Maximum Velocity	V_{max}	m/s	10	1.5
Minimum Velocity	V_{min}	m/s	-10	-1.5
Velocity Resolution	V_{res}	m/s	0.01	0.01
Angular Resolution	θ_{res}	o	2°	2°
Scanning Ability	N/A	N/A	Azimuth Only	Azimuth Only
MIMO Modes	n/a	n/a	CDM, TDM, FDM	CDM, TDM, FDM

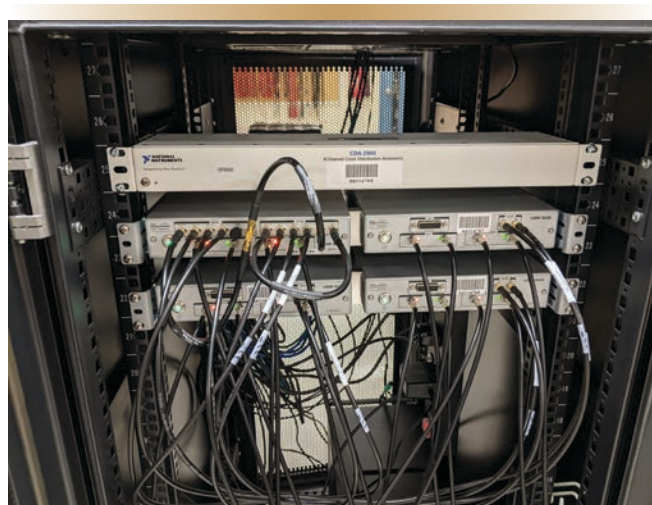

Figure 9. The four software-defined radios (SDRs) and clock distribution unit of the MIMO radar.

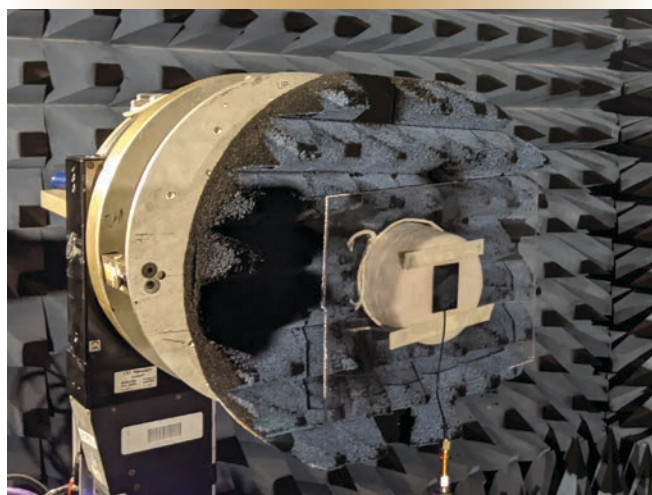

Figure 10. Tagolas 10-GHz ultra-wideband antenna in the anechoic chamber at RMC.

Table 2. MIMO mode AESA radar minimum performance parameters.

Parameter	Surveillance Mode	Lab Mode
AESA Antenna Size (T/R)	8x8	8x8
Operating Frequency (f_0)	5 GHz	5 GHz
Bandwidth (B)	200 MHz	200 MHz
ADC Sampling Frequency ($f_{smp,min}$)	204 MHz	204 MHz
Coherent Operation Capable	Yes	Yes
Range Application	Medium = 150 m	Short = 50 m
Range Resolution	0.75 m	0.75 m

has two transmit and two receive channels, each capable of 200 MHz of instantaneous bandwidth. To obtain the desired beamwidth of two degrees, four SDRs were purchased to provide eight transmit and eight receive RF channels, producing a 64-channel MIMO radar. Figure 9 shows the four SDRs with associated cables and equipment. A 148-core host processor running Linux Mint and GNU Radio performs the required control and signal processing of the MIMO radar.

To construct the antenna array, the Tagolas 10-GHz ultra-wideband antenna was selected. An antenna analysis was conducted in the anechoic chamber at the Royal Military College (RMC) to ensure the individual antenna elements would meet the requirements of the MIMO radar antenna array (Figure 10).

Following the equipment selection, Phase 3 is the design of the MIMO radar architecture and software development in C and C++. A high-level diagram of the architecture is shown in Figure 11.

Moving right to left in Figure 11, an eight-transmit by eight-receive antenna array is constructed using the Tagolas antenna elements. The next block to the left shows the MIMO radar hardware rack, consisting of the four Ettus Research SDRs, and the clock distribution unit. The MIMO radar hardware rack is connected to the host processor. The host processor is running the main radar program and the DSP program used to process the radar data in real-time for display.

Results

The performance of the multi-mode MIMO radar in terms of its ability to detect multiple targets in range, bearing, azimuth and velocity was tested in three different environments, beginning with laboratory. The second environment was inside the RMC Athletic Dome, which provided a wide-open space to test the various parameters of the radar using humans as targets. The third environment was an outdoor test site using marine radar reflectors as

static targets. The MIMO radar operates at very low output power, which ensured the safety of the personnel involved in all stages of testing. Several videos showing the radar in full operation can be found on YouTube at https://youtube.com/playlist?list=PL_lkRDKeAnhpYMzRbNT0yXM1O-xJ4aRwL

The first test environment was the lab (Figure 12), which provided an area to prove the operation of the MIMO radar during development and early radar operation. A target table was used to prove all three dimensions of operation: range, bearing and velocity. One of the key conclusions from the lab testing was that FDM is not usable unless the FMCW waveform is completely separated in frequency. For this reason, FDM research ceased in the lab with the research focus remaining on TDM and CDM.

The second test environment was the RMC Athletic Dome shown in Figures 13 and 14 (inset). This provided a large open space to conduct more extensive testing of the MIMO radar in TDM and CDM modes. The main performance tests conducted inside the dome were a maximum range test and a multiple target test.

(Continues next page...)

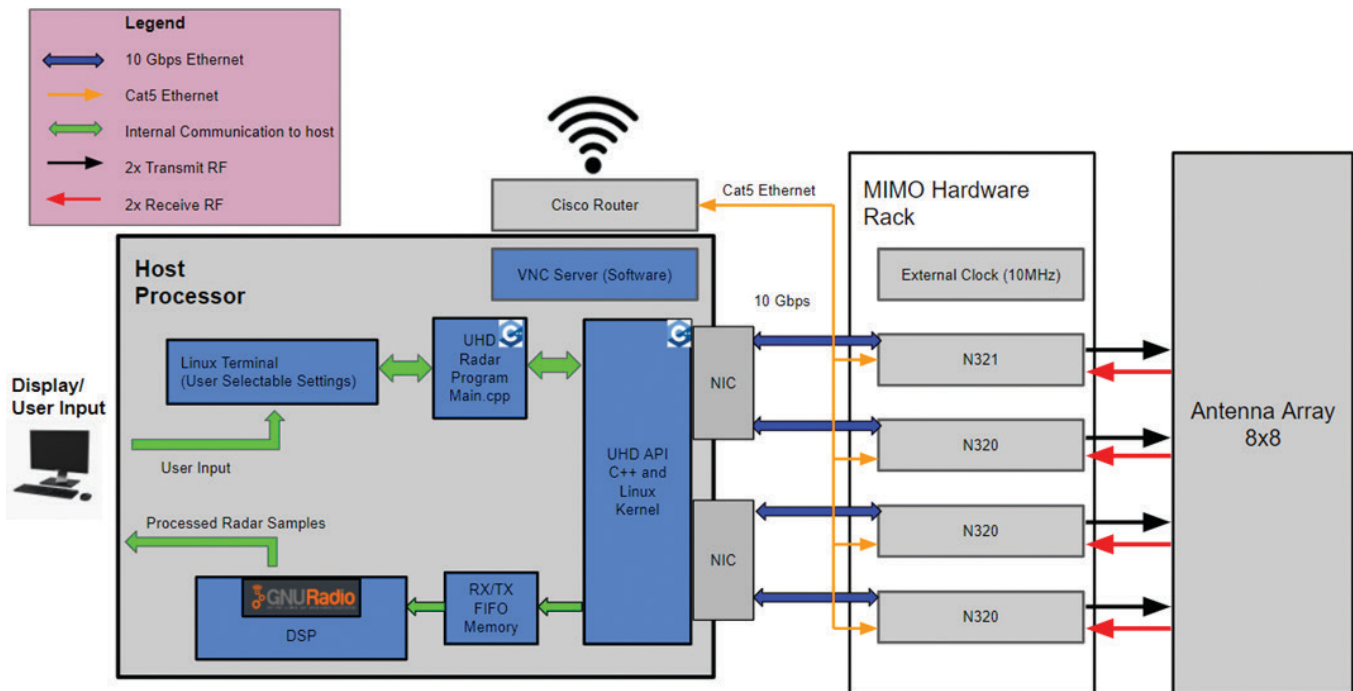

Figure 11. High-level schematic of the MIMO radar. Hardware components are shown in grey, software components in blue.

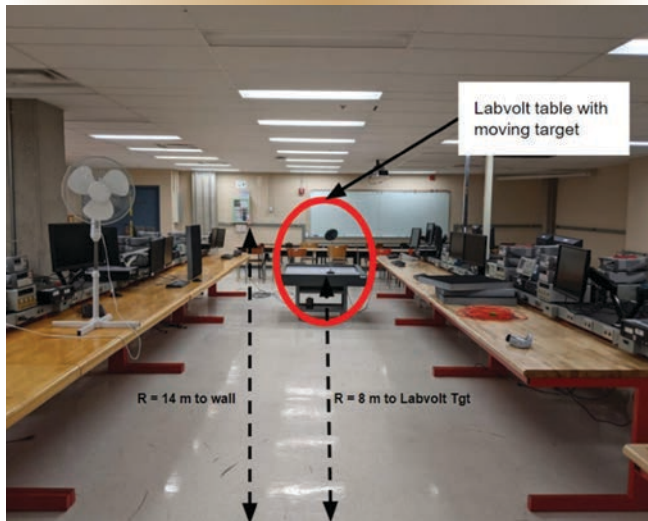

Figure 12. The MIMO radar (antenna) view of the lab testing environment.

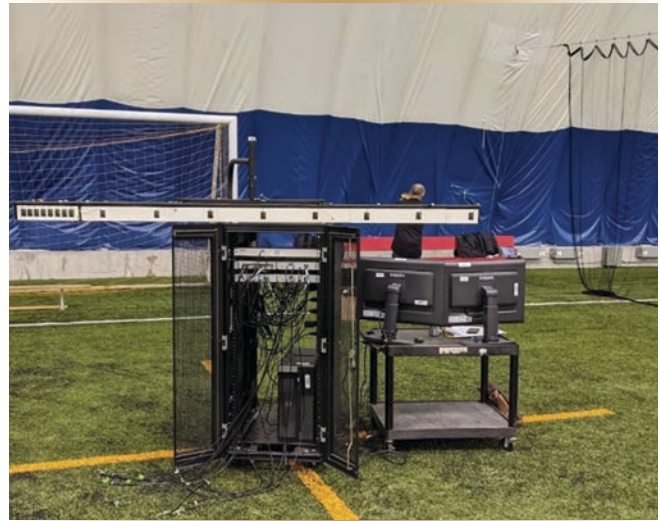

Figure 13. MIMO radar inside the dome.

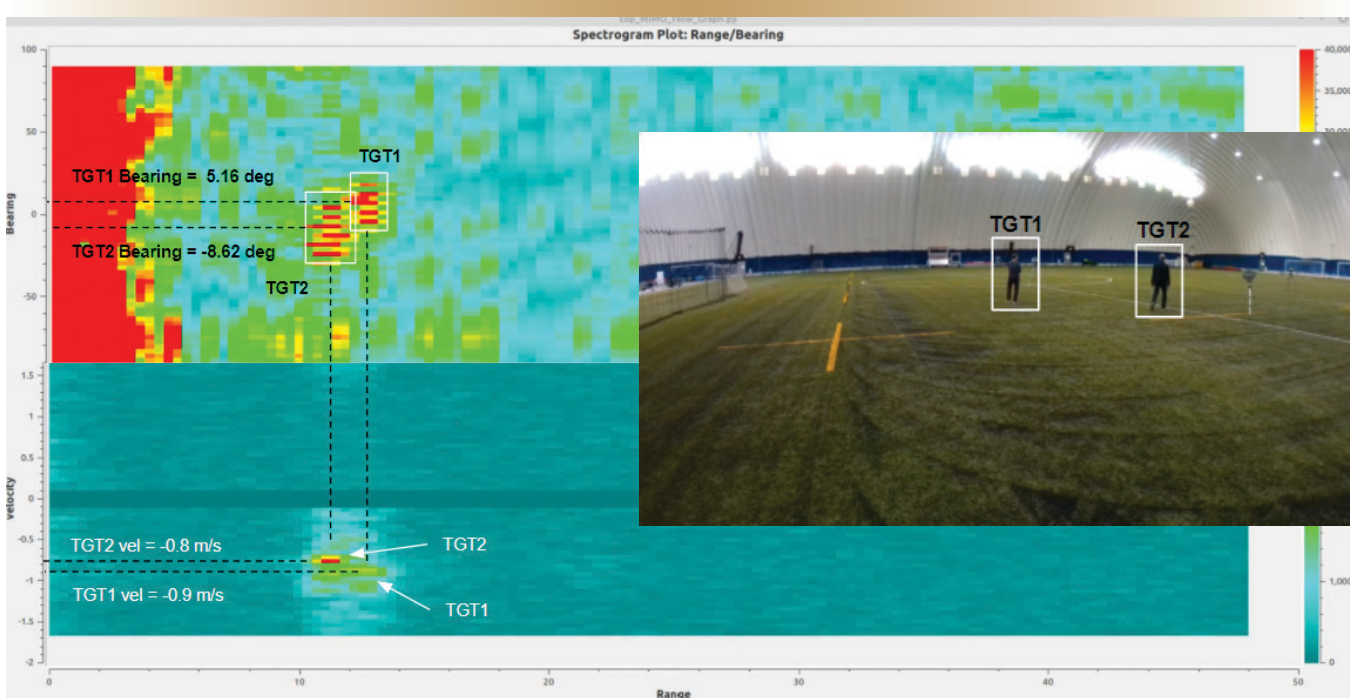

Figure 14. CDM MIMO radar real-time display.

The radar performance in the dome was close to theoretical values for both CMD and TDM. The maximum range for TDM was 21.75 m, and 16.75 m for CDM. A potential cause of the better performance in TDM is that CDM may suffer from random target illumination due to random constructive/destructive interference caused by

the phase coding of the waveform. Both multiplexing methods had similar performance in the multi-target test, with range, velocity, and angular resolution very close to the theoretical values. An example of the operator display is shown in Figure 14, with range vs. bearing on the top display, and range vs. velocity on the bottom display.

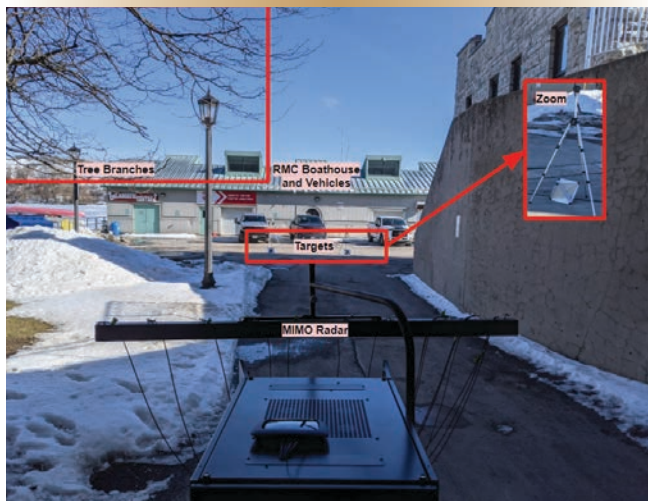

Figure 15. Field of view in the outdoor testing environment.

The outdoor testing location (Figure 15) was used to perform static measurements in CDM mode using marine radar reflectors to obtain a full radar resolution cell. Range and angular resolution tests were conducted in this environment.

Both range and angle tests used peak-to-null separation to show resolution (Rayleigh resolution). The results obtained in CDM mode were a range resolution of 1.75 m (0.75 m theoretical) and angular resolution of 10.5° (1.79° theoretical). Windowing was used in range and angle processing which increases the main lobe by 2.08 times when compared to a rectangular pulse, which is one reason the values are larger than the theoretical values. Another potential reason for the performance not meeting the theoretical values is that the targets are large optically at 1.31°, and electrically at 14° at a range of 20 m. This causes large radar returns in the display which makes fine measurements difficult. Point targets would provide better resolution measurements in this type of testing. The post-processing radar displays showing the range and angular resolution are presented in Figure 16.

Conclusion

This research aimed to do three things, all of which were demonstrated. The first was to create an AESA radar using SDRs capable of MIMO operation. Ettus Research SDRs were used to build a fully functional AESA radar capable of MIMO operation using all three multiplexing techniques. The second aim was to ensure the signal processing

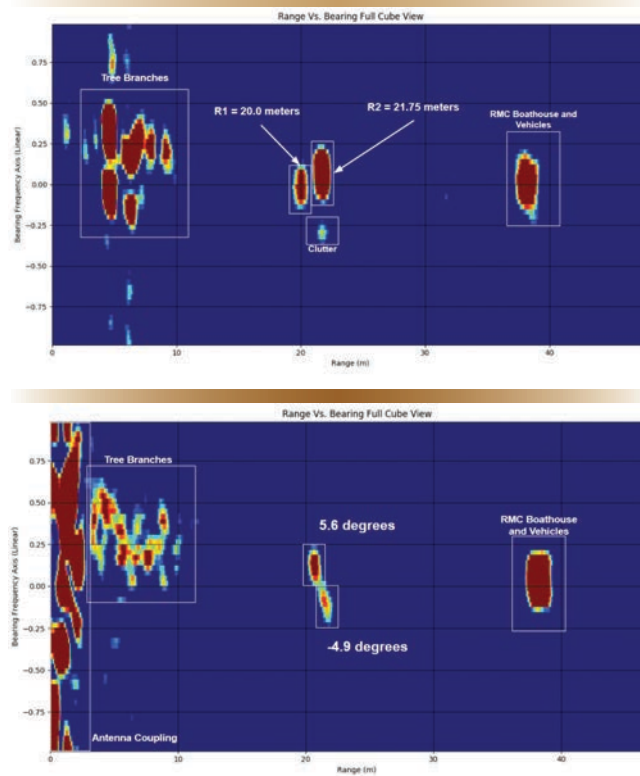

Figure 16. CDM MIMO radar range vs. bearing display, showing a range resolution of 1.75 m (top), and angular resolution of 10.5 degrees (bottom).

remained real-time, which was demonstrated in all three test environments. The final aim of the research was to compare TDM, FDM and CDM modes, which was completed in a multi-target environment.

This research has provided a basis for more work to continue in MIMO radar development by the radar community. It has demonstrated that modern SDRs can be used to build an AESA radar to allow further development of multiplexing strategies for use in MIMO radar. Finally, this research has shown the advantages that MIMO operation could bring to future radars for use in a military or civilian application.



Cdr Gilpin is a Naval Engineer and is currently serving as Senior Combat Systems Manager for the Canadian Surface Combatant Project in Ottawa, Ontario.

Déjà vu!

A second look at stories from our archives.

In 2015, members of the Naval Technical community were honoured to hear Women's Royal Canadian Naval Service (Wren) veteran **Elsa Lessard** speak about her wartime experiences during a special mentorship event that had a most unexpected surprise in store for her. In celebration of the **80th anniversary of the WRCNS**, we offer this second look at a remarkable event from our archives.

Enigmatic surprise for WRCNS veteran code listener Elsa Lessard (From MEJ 78 – Fall 2015)

A very special presentation on Code Listening and Code Breaking during the Second World War was sponsored by DGMEPM and the *Maritime Engineering Journal* at the HMCS Bytown Crow's Nest on Aug. 19, 2015 as part of the Naval Technical Officer mentorship program in the National Capital Region.

Wren veteran **Elsa Lessard**, and spytools collector-historian **Richard Brisson** spoke about the intricacies of intercepting and decoding German wartime messages. Lessard put a personal face on the responsibility and hardships borne by the Wren code listeners in Canada during the war, while Brisson explained the technical aspects of the German Enigma ciphering machine. Two Enigma machines and other artifacts, as well as a special naval display from **Jack Hearfield** were available for close inspection.

As a surprise for Elsa, a special prerecorded Morse code message of thanks for her wartime service had been encoded by Ottawa amateur radio expert **Ralph Cameron** (dit VE3BBM) and enciphered by Brisson using his Enigma



NTO mentorship coordinator Lt(N) Emilie Létourneau shared a quiet moment with Elsa Lessard.



Photo by LCDr Nick Manley

WRCNS veteran code listener Elsa Lessard copies Morse code from a submarine for the first time in more than 70 years.

machine. The message was emailed to **Melissa Raven** at the Museum of Naval History in Port Burwell, ON [see MEJ No. 77, p. 21] so that it could be transmitted back to the group in Ottawa by mobile phone at a prearranged time during the presentation directly from on board the retired RCN submarine *Ojibwa* (standing in as a U-boat) by site manager **Ally Shelly**. As part of the demonstration, Brisson decrypted the message after it was received:

"Congratulations and thank you, Elsa," wrote **Tim Barrett**, President of The Elgin Military Museum/HMCS Ojibwa at Port Burwell. "The work that you and your colleagues did during the Second World War paved the way for Canada's successful Cold War operations. We are in your debt."

As the dot and dash sounds of Barrett's message filled the room on speaker phone, we were delighted as Lessard asked for pen and paper and began copying code from a submarine for the first time since the Second World War. The image was unforgettable.

"I am really moved by this," she said afterward. "I'm overwhelmed. Thank you so much."



Photo by Brian McCullough

Elsa Lessard “Centenarian” Veteran of the Women’s Royal Canadian Naval Service during the Second World War

(Submitted text, courtesy Jack Hearfield)

Elsa Lessard was born in Ottawa on July 2, 1922. Her mother was from Britain and her father was French-Canadian. She went to high school at Lisgar Collegiate in downtown Ottawa, and after graduation joined the federal civil service as a clerk working in the Department of Finance. Dealing with financial records of fallen soldiers brought Elsa a greater awareness of the sacrifices of military personnel during the war.

Elsa came from a proud Navy family. Her older brother Frank was a Wireless Telegraphist in the RCN, responsible for sending and receiving Morse code messages aboard a destroyer at sea. He had a reputation as being one of the fastest signalers in the Canadian Navy, and had taught Morse code to Elsa when she was only 12 years old. Elsa and her younger brother Ossie wanted to be just like Frank, so they both joined the Royal Canadian Navy to do their bit for the country at war.

Elsa joined the Women’s Royal Canadian Naval Service in 1943, and was assigned service number W-1578. Like all new Wren recruits, she received basic training at HMCS *Conestoga*, the Navy training establishment in Galt (now Cambridge), Ontario. Her first trade was Captain’s Writer (a clerk), and she was posted to a new base, HMCS *Cornwallis*, near Digby, Nova Scotia. She was happy for the chance to see her brother Ossie, who was taking his basic training there, and enjoyed the dances and social life of a busy base.

She was soon sent on a Telegraphist course at St. Hyacinthe, near Montreal, and graduated as a Wireless Telegraphist Special Operator, with the rank of Able Wren. She studied electronics theory, and spent hours copying Morse code until everything sounded like Morse code – water pipes knocking, radio static, even music. Even at age 100, Elsa can still say a person’s name in Morse code dots and dashes, as it became a natural language for her.

Elsa was posted to HMCS *Coverdale*, a Special Wireless Station (signals intercept) site on a remote farm near Moncton, New Brunswick. Elsa spent eight-hour shifts sitting in front of a Marconi Model CSR-5 radio receiver tuned to a known frequency, listening attentively through a headset for the distinct tapping sound of the encrypted German Morse code radio messages sent when their U-boats briefly came to the surface. These messages, which had been encoded with the



Photo by Roberta Gal

Enigma machine, were transmitted in five-letter groups that Elsa rapidly transcribed onto paper. This information was transmitted overseas, feeding into the Navy’s overall situational awareness of enemy submarine positions in the Atlantic, allowing them to steer their ships away from these threats, keeping thousands of Allied sailors safer during transit.

Elsa’s brothers Frank and Ossie were on those Navy ships that were sailing through submarine-infested waters in the Atlantic. Elsa’s dedication to her work was motivated by a desire to help keep her brothers safe, as they had done for her. She had already lost two of her friends in the Battle of the Atlantic, and knew the risk of their job at sea. Luckily, both Lessard brothers survived the war, and Elsa had a very close relationship with them the rest of their lives.

Elsa’s dedication as a “Secret Listener” and the contribution of the work of Canadian Wrens in cracking the German Enigma code earned her the Bletchley Park commemorative badge. Elsa’s detailed files and membership lists compiled during her time as President of the Ottawa Branch of the Wrens Veterans Association allowed her to help many other deserving Wrens receive the Bletchley Park badge, after many decades of never being allowed to even speak of the work they had done during the war.

For decades, she has worked to raise awareness about the role of women in the Royal Canadian Navy, and their contribution to Allied victory in the Second World War. In 2008 she was awarded the Minister of Veterans Affairs Commendation for her work. She has represented the Wrens at special commemorations, and in 2012 christened the RCN Monument in Ottawa. In 2019, Elsa Lessard was the guest of honour at the Battle of Atlantic ceremony at the National War Memorial. She still lives in Ottawa, where she celebrated her 100th birthday on July 2.



Titles of Interest

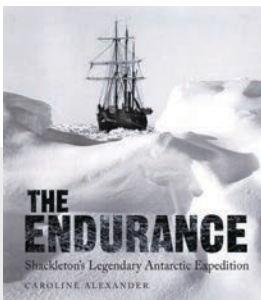

The Endurance: Shackleton's Legendary Antarctic Expedition

By Caroline Alexander

224 pages; 140 black and white photographs

ISBN: 9781526708786, Seaforth Publishing (2017/2021)

<https://www.pen-and-sword.co.uk/The-Endurance-Shackletons-Legendary-Antarctic-Expedition-Paperback/p/14033>

On March 9 of this year, 107 years after Irish-British explorer Sir Ernest Shackleton and his crew watched their ice-damaged ship *Endurance* sink to the bottom of Antarctica's Weddell Sea on Nov. 21, 1915, it was reported that researchers had discovered the 44-metre wooden vessel beautifully preserved, and resting upright at a depth of 3,000 metres.

Shackleton's 1914-1917 Imperial Trans-Antarctic Expedition to cross the continent of Antarctica from sea to sea via the South Pole ultimately failed in achieving its goal, but is best remembered as one of the greatest epics of leadership, resourcefulness, endurance and survival in the annals of polar exploration. The discovery of his "lost ship" makes this an opportune time to relive this remarkable episode in history through author Caroline Alexander's illustrated account of the expedition.

Drawing upon previously unavailable sources, the book presents the astonishing work of Australian expedition photographer Frank Hurley, whose visual record of the adventure was never before published comprehensively. Together, text and images recreate the terrible beauty of Antarctica, the awful destruction of the ship, and the crew's heroic daily struggle to stay alive, a miracle achieved largely through Shackleton's inspiring leadership.

The survival of Hurley's remarkable images is scarcely less miraculous: The original glass plate negatives, from which most of the book's illustrations are superbly reproduced, were stored in hermetically sealed canisters that survived months on the ice floes, a week in an open boat on the south polar seas, and several more months buried in the snows of a rocky outcrop called Elephant Island. When he was forced to abandon his professional equipment, Hurley captured some of the most unforgettable images of the struggle with a pocket camera and three rolls of Kodak film.

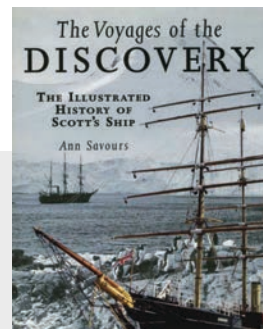

The Voyages of the Discovery: The Illustrated History of Scott's Ship

By Ann Savours

160 pages;

ISBN: 9781848327023, Seaforth Publishing (2013)

<https://www.pen-and-sword.co.uk/The-Voyages-of-the-Discovery-Paperback/p/3902>

Thirteen years prior to Sir Ernest Shackleton's 1914-1917 Trans-Antarctic Expedition, the Royal Geographical Society had proposed a National Antarctic Expedition as, even by the turn of the twentieth century, the southern continent remained largely a mystery. With this proposition came the design of the auxiliary steamship *Discovery*, the last traditional, three-masted wooden ship to be built in the United Kingdom.

Based on the design of a whale ship, *Discovery* was purpose-built in Dundee, Scotland to withstand ice, and was equipped with a hoisting propeller and rudder for Captain Robert Scott's acclaimed expedition of 1901-1904, which took both him and his third officer, Ernest Shackleton, to the Antarctic for the first time. As author Ann Savours describes in her book, one year after its return to Britain, *Discovery* was purchased by the Hudson's Bay Company, and worked as a cargo carrier between London and the HBC trading posts in the Canadian Arctic before becoming a royal research ship in 1925.

In 1916, *Discovery* was loaned to the British government and sent to rescue Shackleton's men on Elephant Island following the loss of *Endurance* almost a year earlier. The mission was aborted when news reached them that Shackleton himself had gone back for his crew. *Discovery* became a static training ship on the Thames at London in 1936. In 1986, the ship was transported back to Dundee, where it remains on permanent display.

— Edited by Ashley Evans





NEWS

 (SUMMER 2022)

Canadian Naval Technical History Association

CNTHA News
Est. 1997

CNTHA Chairman
Pat Barnhouse

CNTHA Executive Director
Tony Thatcher

**Directorate of History and
Heritage Liaison**
Michael Whitby

**Maritime Engineering
Journal Liaison**
Brian McCullough

Webmaster
Peter MacGillivray

Webmaster Emeritus
Don Wilson

CNTHA News is the unofficial newsletter of the Canadian Naval Technical History Association. Please address all correspondence to the publisher, attention Michael Whitby, Chief of the Naval Team, Directorate of History and Heritage, NDHQ
101 Colonel By Dr
Ottawa, ON K1A 0K2
Tel. (613) 998-7045
Fax (613) 990-8579

Views expressed are those of the writers and do not necessarily reflect official DND opinion or policy. The editor reserves the right to edit or reject any editorial material.

www.cntha.ca

Burrard Dry Dock and the Construction of Destroyer Escorts on the West Coast

By Dr. Chris Madsen

During the 1950s, Burrard Dry Dock emerged as the dominant shipbuilder working for the Royal Canadian Navy (RCN) on Canada's west coast. Leveraging an impressive record of building and converting ships for war purposes during the Second World War, Burrard Dry Dock's management team made several strategic moves to improve its business position, beginning with the 1946 purchase of Yarrows in Esquimalt. Its proximity to the government-operated Esquimalt Graving Dock, built in 1926, and the adjacent RCN dockyard afforded privileged access.

In 1951, Burrard Dry Dock bought out Pacific Dry Dock, its next-door competitor in North Vancouver, which added valuable equipment and even more skilled workers. This left Harold Husband's Victoria Machinery Depot as the only other principal operating shipyard in the province, which was subsequently purchased by Burrard Dry Dock in 1967. The president of the consolidated Burrard Dry Dock company was Clarence Wallace, a man known for his financial and corporate acumen. When he was appointed Lieutenant-Governor of British Columbia in October 1950, and until he returned to active management of Burrard Dry Dock in September 1955, each of the Burrard shipyards was run by a separate manager.

Combined with the subsidiary Yarrows shipyard in Esquimalt, Burrard Dry Dock became the single largest shipyard employer in British Columbia. With extensively modernized and expanded facilities, the company joined the ranks of nationally recognized and top-tiered shipyards in Montreal and Lévis, Quebec, and Halifax, Nova Scotia, all of whom were bidding on government contracts. After the United Nations action in Korea (1950-1953), the federal government committed to maintaining a workforce of 7,000 in Canada's shipbuilding industry to meet national security interests. Though some commercial work continued, Burrard Dry Dock duly became a privileged supplier to the federal government. For the better part of the next 15 years, Burrard's North

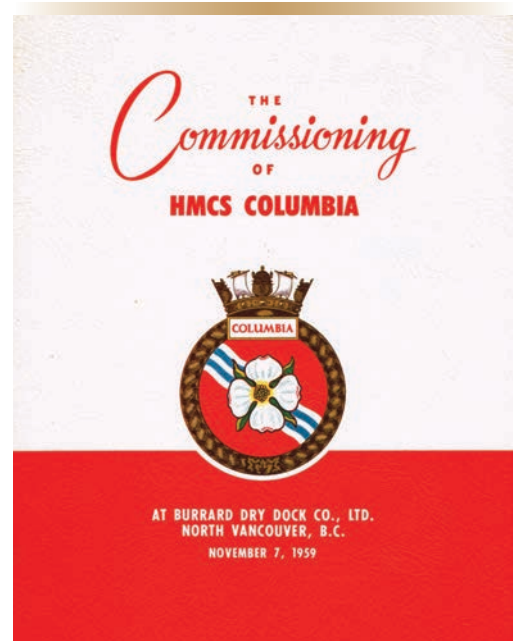

Source: Chris Madsen

Cover of the official commissioning booklet for HMCS *Columbia* on November 7, 1959.

Vancouver and Esquimalt shipyards focused almost exclusively on high-value public procurement contracts on behalf of the RCN and the Department of Transport's Marine Service.

At the time, the Navy was procuring steam-driven destroyer escorts (DEEs) — mid-range warships specialized for anti-submarine warfare (ASW) — as part of Canada's alliance contributions during the Cold War. The DEEs came in several variants, including the initial *St. Laurent* (205) class, the slightly larger *Restigouche* (257) class with better anti-aircraft arrangements and sensors, and the budget-friendlier modified repeat *Mackenzie* (261) class. The naval headquarters in Ottawa prepared drawings and offered technical advice to the selected shipyards, with Burrard Dry Dock constructing ships for each of the three classes. All of Canada's DEEs were named after major rivers. Several years passed between launch and commissioning due to the extensive fitting-out done in North Vancouver and Esquimalt (see table). Resident naval staff headed by

(Continues next page)

Table 1.
Destroyer escorts built and commissioned at Burrard Dry Dock.

Ship	Launched	Commissioned
<i>St Laurent class</i>		
DDE-207 HMCS <i>Skeena</i>	19 August 1952	30 March 1957
DDE-233 HMCS <i>Fraser</i>	19 February 1953	28 June 1957
<i>Restigouche class</i>		
DDE-258 HMCS <i>Kootenay</i>	15 June 1954	7 March 1959
DDE-260 HMCS <i>Columbia</i>	1 November 1956	7 November 1959
<i>Mackenzie class</i>		
DDE-263 HMCS <i>Yukon</i>	27 July 1961	25 May 1963

a technical commander and overseers for hull, engineering, electrical, ordnance and supply acted on behalf of the Department of Defence Production (Shipbuilding) in execution of the contracts, and made sure the RCN's specifications were fully met.

The destroyer escort was a Canadian design with British influences that incorporated dual-shaft English Electric steam turbines and Babcock & Wilcox boilers for propulsion, distinctive “rounded-down” weather decks for prevention of ice-buildup in cold weather, closed ventilation and contamination clearing systems for nuclear warfighting, and by the standards of the day, comparatively deluxe crew accommodation. Novel production techniques beyond the normal commercial work seen at Burrard Dry Dock had included pickling steel plates in acid baths, and a greater use of aluminum in the superstructure to save on weight. Additionally, in the plate shop, bonderizing of aluminum shapes and forms was done using a three-part process of dipping items in solutions for cleaning, then etching to remove the normal bright condition prior to spray painting with a protective zinc chromate primer. The “as fitted” machinery space installations for piping, electrical conduits, and ventilation trunking often depended upon which shipyard trade had performed the initial work.

Once completed, the Burrard Dry Dock-built destroyer escorts received weaponry and special equipment at a naval armament depot beside Lynn Creek in North Vancouver. HMCS *Skeena* and HMCS *Fraser* had twin 3-inch 50-calibre dual-purpose guns forward and aft, and two single-mount 40-mm Boffin guns. HMCS *Kootenay* and HMCS *Columbia* substituted a twin-mount 3-inch 70 forward, retained the 3-inch 50 twin mount aft, and dispensed entirely with the Boffins. Each destroyer escort employed the quarterdeck-mounted Limbo Mk 10 mortar as the main ASW offensive armament, an effective weapon

with a 1,000-yd range that could be controlled in both direction and range, and fired, by sonar operators from their compartment off the ship's operations room. HMCS *Yukon* added the American designed Mk 43 lightweight anti-submarine torpedo, launched “over the side” using a modified depth-charge thrower. A planned “*Vancouver* class” geared toward rapid construction in the event of war, being less capable and five knots slower than the destroyer escort, was shelved due to advances in naval warfare and the capabilities of the Soviet forces.

The destroyer escorts were slower at top speed than newer Soviet nuclear submarines, but they typically operated in groups of two or more to locate and engage a target with their high-explosive mortars. The RCN also pioneered the employment of shipborne helicopters as ASW sensor and weapon platforms, made possible by a new Canadian invention for deck landings, the bear trap, added later in conversions from DDE to DDH, and to the DDH-constructed *Annapolis* (265) class.

The production of destroyer escorts was a significant achievement for Burrard Dry Dock and a boon to Canada's domestic shipbuilding industry. The company and its workers progressively improved technical skills, quality of work, productivity, and cost estimations across their contracts and individual warships. Naval authorities also relearned how to manage and supervise major National Defence projects. While the Canadian-designed and -constructed DDEs were technologically obsolete in the face of changing naval warfare even before completion, they provided useful service in the Royal Canadian Navy for many decades, and far beyond their original intended ASW role as both operational and training platforms. Following on the destroyer escorts, Burrard Dry Dock received contracts for icebreakers from the Department of Transport's Marine Service, subsequently known in 1962 as the Canadian Coast Guard, to ensure continuity of government work and to maintain steady employment in the shipbuilding industry.

The construction of destroyer escorts reflected a relatively golden time for Burrard Dry Dock, Canadian shipbuilding in general, and the Royal Canadian Navy when policy coalesced to have a made-in-Canada solution to meet naval requirements, with both possibilities and limitations. It therefore remains an important and salient chapter in the Royal Canadian Navy's technical history.



Dr. Chris Madsen is a Professor in the Department of Defence Studies at the Canadian Forces College and Royal Military College of Canada in Toronto, Ontario.

HMCS *Kootenay* leaving Vancouver harbour after commissioning at Burrard Dry Dock in March 1959. This destroyer escort was one of five constructed at the company's North Vancouver Shipyard.



Source: Chris Madsen