



PAC 200

Canadian **Sailing Directions**

General Information, Pacific Coast

2022/05











Fisheries and Oceans
Canada

Pêches et Océans
Canada

Canada 

Pictograph legend

	Anchorage		Current		Radio calling-in point
	Wharf		Caution		Lifesaving station
	Marina		Light		Pilotage

Report discrepancies between real-world observations and descriptions in the publication

Users of this publication are requested to forward information regarding newly discovered dangers, changes in aids to navigation, the existence of new shoals or channels, or other information that would be useful for the correction of nautical charts and publications affecting Canadian waters to: chsinfo@dfo-mpo.gc.ca.

IMPORTANT NOTICE

The Canadian Hydrographic Service no longer produces hard copies of its publications.

Updates are published in Notices to Mariners at notmar.gc.ca
and on the Canadian Hydrographic Service website at charts.gc.ca

REPRODUCTION FOR PERSONAL USE

This digital publication - as published in charts.gc.ca - may be printed or reproduced in any format, without charge or further permission, provided that it is for non-commercial purposes, i.e. not for sale or any profit whatsoever.

To be used for navigation, the reproduction must be an unaltered, true copy of the publication found in charts.gc.ca, and kept up-to-date at all times.

REPRODUCTION FOR COMMERCIAL PURPOSES

This publication shall not be printed or otherwise reproduced in whole or in part for commercial purposes (i.e. in the purpose of sale or any profit whatsoever, as opposed to personal use), without prior written permission from the Canadian Hydrographic Service.

For full terms and conditions, visit
charts.gc.ca or email chsinfo@dfo-mpo.gc.ca.

Published under the authority of the
Canadian Hydrographic Service
Fisheries and Oceans Canada
200 Kent Street, Ottawa, Ontario, Canada, K1A 0E6

© Her Majesty the Queen in Right of Canada, 2022
Catalogue No. Fs74-67E-PDF
ISSN 2816-5098
Ottawa

Record of Changes

As the CHS acquires new information, relevant changes are applied to Sailing Directions volumes in order to maintain safety of navigation. It is the responsibility of the mariner to maintain their digital Sailing Directions file by ensuring that the latest version is always downloaded. Visit charts.gc.ca to download the most recent version of this volume, with all current changes already incorporated.

The table below lists the changes that have been applied to this volume of Sailing Directions. This record of changes will be maintained for the current calendar year only

Date	Chapter / Paragraph	Description of Change
05/2022	Chapter 2 Par. 126	Change the name of Canadian Coast Guard Auxiliary (CCGA) to Royal Canadian Marine Search and Rescue (RCM-SAR)
05/2022	Chapter 3 Par. 40	Delete: VHF Radiotelephone Practices and Procedures Regulations

TABLE OF CONTENTS

	Preface _____	V
	Explanatory notes _____	VI
	Abbreviations _____	VIII
CHAPTER 1	General Information, Routes and Port Facilities	
	Canada _____	1-1
	British Columbia _____	1-2
	Transportation _____	1-3
	Communications _____	1-5
	Vessel Traffic Services (VTS) _____	1-5
	Border Crossing _____	1-8
	Security _____	1-10
	Regulations _____	1-12
	Routes _____	1-12
	Pilotage _____	1-17
	Port Facilities and Services _____	1-20
CHAPTER 2	Navigational Hazards	
	Seamounts _____	2-1
	Hydrographic and Seismic Surveys _____	2-1
	Firing Practice and Exercise Areas _____	2-2
	Fishing Vessels _____	2-3
	Aquaculture _____	2-6
	Traffic _____	2-6
	Cables and Pipelines _____	2-8
	Bridges _____	2-9
	Magnetic Anomalies _____	2-9
	Natural Environment and Protected Areas _____	2-10
	Search and Rescue _____	2-12
	Cold Water Survival _____	2-16
CHAPTER 3	Aids to Navigation, Radio and Electronic Positioning	
	Aids to Navigation _____	3-1
	Radio Aids to Navigation _____	3-3
	Radar _____	3-7
	Global Navigation Satellite Systems _____	3-8
CHAPTER 4	Nautical Publications	
	CHS Publications _____	4-1
	Nautical Charts _____	4-3
	CCG and Other Publications _____	4-9
CHAPTER 5	Natural Conditions	
	Seabed _____	5-1
	Meteorology _____	5-2
	West Vancouver Island _____	5-5
	Juan de Fuca Strait _____	5-6
	Strait of Georgia _____	5-7
	Johnstone Strait Region _____	5-9
	Northern Shelf Region _____	5-9
	Deep Sea Region _____	5-10
	Water Density _____	5-10
	Ice _____	5-11
	Tide and Current Information _____	5-12
	Tides _____	5-12

	Surface Currents	5-12
	Tidal Currents	5-16
	Non-tidal Currents	5-17
	Waves	5-23
	Tsunami	5-26
APPENDICES	Sail Plan	A-1
	Distance Tables	A-3
	Wind Tables	A-7
	Frequency of Fog	A-11
	Beaufort Scale of Wind Force	A-12
	Federal and Provincial Powers for Protecting Marine Areas	A-13
	Metric Conversion Table	A-14
DIAGRAMS	Area of Application of Canada's Oceans Strategy	1-3
	Main Shipping Routes to/from Alaska and Japan	1-13
	Main Shipping Routes – BC South Coast	1-14
	Main Shipping Routes – BC North Coast	1-15
	Pilot Boarding Stations	1-18
	Commercial Fishing Methods	2-5
	Typical Aquaculture Site Layouts	2-7
	Kelp	2-10
	Life Expectancy in Water	2-15
	Survival in Cold Water	2-16
	Basic requirements for GPS signal generation	3-9
	Examples of Obstruction Errors	3-10
	Relation between tidal surfaces, charting datums and physical features	4-4
	Source Classification Diagram	4-6
	Sounding Methods	4-7
	Five Easy Steps for Updating your Nautical Chart	4-10
	Tidal Stream Information (TSI 1)	5-13
	Tidal Stream Information (TSI 2)	5-14
	Tidal Stream Information (TSI 3)	5-15
	Stages of Tidal Streams	5-16
	Distribution of Surface Currents of the North Pacific Ocean	5-18
	General Circulation (Winter)	5-19
	General Circulation (Spring)	5-20
	General Circulation (Summer)	5-21
	General Circulation (Autumn)	5-22
	Non-tidal Surface Currents	5-23
	Wave Statistics	5-24
	Index	I-1

The Second Edition of *Sailing Directions, PAC 200 — General Information, Pacific Coast, 2006*, has been fully updated from Canadian Government and other information sources. In general, all hydrographic terms used in this booklet are in accordance with the meanings given in the *Hydrographic Dictionary (Special Publication No. 32)*, published by the International Hydrographic Bureau.

General information for the British Columbia coast is given in this booklet. It contains navigational information and a brief description of the main port facilities as well as geographic, oceanographic and atmospheric characteristics.

Detailed descriptions of geographical areas are given in a series of booklets. Their limits are printed on the back cover. **The appropriate descriptive booklet(s) of *Sailing Directions* should be consulted in conjunction with this *PAC 200 — General Information* booklet.**

Tide and current information revised by the Canadian Hydrographic Service.

Meteorological information supplied by the Atmospheric Environment Service, Environment Canada.

Photographs by the Canadian Hydrographic Service unless otherwise indicated.



Canadian *Sailing Directions* amplify charted details and provide important information of interest to navigation which may not be found on charts or in other marine publications. *Sailing Directions* are intended to be read in conjunction with charts quoted in the text.

Remarks

Buoys are generally described in detail only where they have special navigational significance, or where the scale of the chart is too small to clearly show all the details.

Chart references, in italics in the text, normally refer to the largest scale Canadian chart but occasionally a smaller scale chart may be quoted where its use is more appropriate.

Distance tables contain approximate distances only that are based on tracks usable by most vessels consistent with safe navigation.

Facilities available to the general public are described. Floats and wharves that are not described can be assumed to be privately owned. Marina facilities are listed in the Appendix of the appropriate geographic books of *Sailing Directions*.

Magnetic Compass Roses must be corrected for annual change in variation.

Names have been taken from the Geographical Names Board of Canada. Where an obsolete name still appears on the chart, it is given in brackets following the official name. http://geonames.nrcan.gc.ca/index_e.php

Tidal information relating to the vertical movements of the water is not given and the *Canadian Tide and Current Tables, Volumes 5, 6 and 7* should be consulted. However, abnormal changes in water level are mentioned.

Wreck information is included where drying or submerged wrecks are relatively permanent features having significance for navigation or anchoring.

Units and terminology

A-frames are derricks generally constructed of logs formed in the shape of the letter “A”. They are used for lifting bundles of logs from logging trucks to water and are usually conspicuous.

Bearings and **Courses** refer to True North (geographic) and are given in degrees from 000° clockwise to 359°. Bearings of conspicuous objects, lights, ranges and light sectors are given

from seaward. Courses always refer to course to be “made good”.

Booming grounds can be either areas where logs are yarded and formed into sections, or areas where booms and sections are stored. They are generally private areas, holding water leases, which restrict public usage.

Broken water – a general term for a turbulent and breaking sea in contrast to comparatively smooth and unbroken water in the vicinity.

Clearances under bridges, overhead cables, etc., are those at HHWLT.

Conspicuous objects, natural or artificial, are those which stand out clearly from the background and are easily identifiable from a few miles offshore in normal visibility.

Deadheads/Sinkers are logs that have become so waterlogged that they are almost entirely submerged. They usually assume a vertical position; if water is shallow enough for their bottom end to be aground they can cause massive damage to a hull. They are invisible even in daylight unless a slight swell causes them to break surface.

Dead-weight tonnage and **mass** are expressed in metric tonnes of 1,000 kilograms. The kilogram is used for expressing relatively small masses.

Depths, unless otherwise stated, are referred to chart datum. As depths are liable to change, particularly those in dredged channels and alongside wharves and floats, it is strongly recommended that when critical these be confirmed by enquiry to the appropriate authority.

Distances, unless otherwise stated, are expressed in nautical miles. For practical purposes, a nautical mile is considered to be the length of one minute of arc, measured along the meridian, in the latitude of the position. The international nautical mile, which has now been adopted by most maritime nations, is equal to 1,852 m.

Elevations on land are given above HHWLT. Elevations of wooded islands, points, etc., are to tops of trees. **Heights** of objects, as distinct from the elevations, refer to the heights of structures above ground.

Figures in brackets given after those denoting fathoms, feet or yards, are their equivalent in metres. Those following lights and light buoys are their Canadian Light List number.

HHWLT (Higher High Water, Large Tide) is the highest predictable tide during an average year in the nineteen year lunar cycle.

HW (High Water) refers to the highest water level achieved during one tidal cycle.

LLWLT (Lower Low Water, Large Tide) is the lowest predictable tide during an average year in the nineteen year lunar cycle.

LW (Low Water) is the lowest water level achieved during one tidal cycle.

Latitudes and Longitudes given in brackets are approximate and are intended to facilitate reference to the general area on the chart quoted. They should not be used for navigation or as waypoints.

Logbooms are a collection of logs formed into units suitable for towing. They are generally oblong and can range up to 76 m wide and 360 m long. Logbooms are encircled and contained by **boomsticks** formed by logs chained together end to end.

Log dumps are areas where logs are dumped either from A-frames or log ramps. Usually the area is blocked off by boomsticks and pilings.

Prevailing refers to the wind or current most commonly observed during a specified period, such as a month or season.

Public wharf is generally available for public use, though certain fees may be charged by local authorities. Some wharves may give berthing priority to the local fishing fleets or other agencies.

Radar beacons (Racon) are beacons which respond to radars; a full description is given in *Radio Aids to Marine Navigation (Pacific and Western Arctic)*.

Rectilinear stream is a tidal stream which runs alternatively in approximately opposite directions, with a period of slack water in between.

Rotary streams are tidal streams, the direction of which gradually turns either clockwise or anti-clockwise through 360° in one tidal cycle.

Slack water is that period of negligible horizontal water movement when a rectilinear tidal stream is changing direction.

Small craft is used to designate pleasure craft and in general, small vessels with shallow draught.

Swell is wave motion caused by a meteorological disturbance, which persists after the disturbance dies down or moves away.

Tidal streams and currents are described by the direction toward which they flow. The **ebb** stream is caused by a falling tide and the **flood** stream is caused by a rising tide.

Time, unless otherwise stated, is expressed in Pacific standard or daylight time.

Whirlpool is an eddy or vortex of water. Any body of water having a more or less circular motion, caused by it flowing in an irregular channel, or by conjunction of opposing currents.

Winds are described by the direction from which they blow.



Related Publications

Canadian Hydrographic Service (www.charts.gc.ca)

- *Catalogue of Canadian Nautical Charts and Related Publications (Pacific)*
- *Chart No. 1 Symbols, Abbreviations and Terms*
- *Canadian Tide and Current Tables, Volumes 5, 6 and 7*
- *Canadian Tidal Manual*

Canadian Coast Guard (www.ccg-gcc.gc.ca)

- *Pacific Coast List of Lights, Buoys and Fog Signals*
- *Radio Aids to Marine Navigation (Pacific and Western Arctic)*
- *Notices to Mariners 1 to 46 Annual Edition*
- *The Canadian Aids to Navigation System*

National Oceanic and Atmospheric Association (www.chartmaker.ncd.noaa.gov)

- *United States Coast Pilot 7 and 8*
-

Units

°C	degree Celsius
cm	centimetre
fm	fathom
h	hour
ha	hectare
kHz	kilohertz
km	kilometre
kn	knot
kPa	kilopascal
m	metre
min	minute
MHz	megahertz
mm	millimetre
ft	foot
t	metric tonne
°	degree (plane angle)
'	minute (plane angle)

Directions

N	north
NNE	north northeast
NE	northeast
ENE	east northeast
E	east
ESE	east southeast
SE	southeast
SSE	south southeast
S	south
SSW	south southwest
SW	southwest
WSW	west southwest
W	west
WNW	west northwest
NW	northwest
NNW	north northwest

Various

CCG	Canadian Coast Guard
CHS	Canadian Hydrographic Service
HF	high frequency
HW	high water
LW	low water
MCTS	Marine Communications and Traffic Services
M	million, mega
NAD	North American Datum
ODAS	Ocean Data Acquisition System
SAR	Search and Rescue
VHF	very high frequency
VTS	Vessel Traffic Services

General Information, Routes and Port Facilities

Canada



1 **Canada** is the largest country in the Western Hemisphere and the second largest in the world. Land and fresh-water areas cover almost 10 million square kilometres (km²). The saltwater shoreline measures 243 000 km.

2 The national capital of Ottawa is in the province of Ontario. The city is situated on the south shore of the Ottawa River which separates the provinces of Ontario and Quebec. For more information see <http://www.canada.gc.ca/>.

3 **Constitution.** — Canada began formal constitutional development in 1663, a century before the transfer of rule from France to Britain in 1763. In 1982, the Canada Act patriated (severed from British Parliament) the Canadian Constitution. This was the final act of the British Parliament in Canadian constitutional development. The Canadian federation has also evolved through a step-by-step process of non-constitutional reform in the form of, for example, the Canadian Charter of Rights and Freedoms.

4 **Government of Canada.** — The structure of the Canadian federal government is comprised of executive, legislative and judicial branches.

5 The executive branch includes the Queen (or current reigning British monarch), the Governor-General (the Queen's representative in Canada), the Prime Minister, cabinet, and ministries and departments that provide government goods and services.

6 The legislative branch is the lawmaking branch of government and consists of those government bodies responsible for passing legislation. This branch includes two houses of parliament: the House of Commons (lower chamber) and the Senate (upper chamber). The Prime Minister and Cabinet are responsible to the House of Commons.

7 The judicial branch consists of the court system and includes the Supreme Court of Canada, Federal Court of Canada, and Tax Court of Canada.

8 **Provincial governments** are also structured by executive, legislative and judicial branches. In each province the Queen is represented by a Lieutenant-Governor. The Lieutenant-Governor acts on advice and with assistance of the Premier of the province and their Ministry who are responsible to the provincial legislature.

9 The legislature of each province is unicameral, consisting of the Lieutenant-Governor and a Legislative

Assembly. The assembly is elected by the people for a statutory term of five years but can be dissolved within that period by the Lieutenant-Governor on the Premier's advice.

10 **Territorial Governments.** — Yukon Territory, Northwest Territories and Nunavut are each governed by a Commissioner, appointed by the Government of Canada, and a legislative council elected by the people. The Commissioners function in the same capacity as provincial Lieutenant-Governors.

11 **Legal System.** — Civil law in each of the provinces — with the exception of Quebec — and in the three territories derives from the common law of England. Criminal law of Canada is based on criminal law of England.

12 In Quebec, the system has been influenced by legal developments in France, resulting in Quebec's own Civil Code and Code of Civil Procedure. Over the years, both Canadian common law and Quebec civil law have developed unique characteristics.

13 **Police forces** in Canada are organized into three groups:

1. Federal force — the Royal Canadian Mounted Police (RCMP);
2. Provincial police forces — in Ontario (Ontario Provincial Police) and in Quebec (Quebec Provincial Police – Sûreté du Québec);
3. Municipal police forces — available in most urban centres.

14 Canadian National Railways and Canadian Pacific Railway Company also have their own police forces.

15 **Official Languages.** — English and French are the official languages of Canada and have equality of status and equal rights and privileges as to their use in all institutions of Parliament and the government of Canada.

16 **Population.** — In 2006, the population of Canada was about 32.1 million. In British Columbia it approached 4.2 million.

17 **Currency.** — The Bank of Canada is the only bank note-issuing authority and is responsible for designing, producing and distributing Canada's bank notes. The Canadian dollar (CAD or C\$) is available in \$5, \$10, \$20, \$50 and \$100 denominations.

18 Canadian coins are produced and issued by the Royal Canadian Mint and are available in 1¢, 5¢, 10¢, 25¢, 50¢, \$1 and \$2 denominations.

19 **Weights and Measures.** — Canada uses the metric system based on the kilogram, litre and metre.

19.1 **Time Zone.** — The standard time of British Columbia is **Pacific Standard Time** that is 8 hours slow of Coordinated Universal Time (UTC -8h). During summer months, second Saturday in March to first Sunday in November, Pacific Daylight Time is in effect. Clocks are

advanced 1 hour (UTC -7h) <http://www.nrc-cnrc.gc.ca/eng/services/inms/time-services/time-zones.html>.

20 **Maritime Zones.** — The Canada Oceans Act (1996) defines four maritime zones.

21 **Territorial Sea** consists of a belt of sea that has, as its baseline, the low-water line along the coast, to an outer limit of 12 nautical miles.

22 **Contiguous Zone** consists of an area of sea that extends 12 nautical miles from the outer limit of the territorial sea or 24 nautical miles from the baseline of the territorial sea.

23 **Exclusive Economic Zone** has as its inner limit the outer limit of the territorial sea and its outer limit as 200 nautical miles from the baseline of the territorial sea.

24 **Continental Shelf** includes the seabed and subsoil of submarine areas, including the Exclusive Economic Zone, to a distance of 200 nautical miles from the baseline of the territorial sea where the outer edge of the continental margin does not extend up to that distance.

25 For further information on Canada's marine sovereign rights, jurisdiction, enforcement of federal laws and limitations see http://www.pac.dfo.mpo.gc.ca/oceans/Oceans-Act/oceansact_e.htm.

British Columbia

26 **British Columbia.** — Canada's westernmost province shares both land and marine boundaries with the United States of America at Alaska to the northwest and Washington to the south. British Columbia is the only Canadian province bordering the Pacific Ocean. The British Columbia saltwater shoreline is approximately 27 725 km. Vancouver Island and Haida Gwaii are the largest islands lying off the west coast of British Columbia. For more information see <http://www.gov.bc.ca/bvprd/bc/home.do>.

27 **Vancouver Island.** — Oriented in a northwest-southeast direction, Vancouver Island is about 450 km long with an average width of 70 km. Total land mass is approximately 32 000 km² with a highest elevation of 2 200 m above sea level. To the south, it is separated from the United States of America by Juan de Fuca Strait, Haro Strait and Boundary Pass. To the north, it is separated from the British Columbia mainland by the Strait of Georgia, Discovery Passage, Johnstone Strait and Queen Charlotte Strait. The coast of Vancouver Island is deeply indented with bays and inlets forming numerous deep-water harbours.

28 **Haida Gwaii.** — This archipelago of about 150 islands and islets is separated from the northwest coast of British Columbia by Hecate Strait and from Alaska by Dixon Entrance.

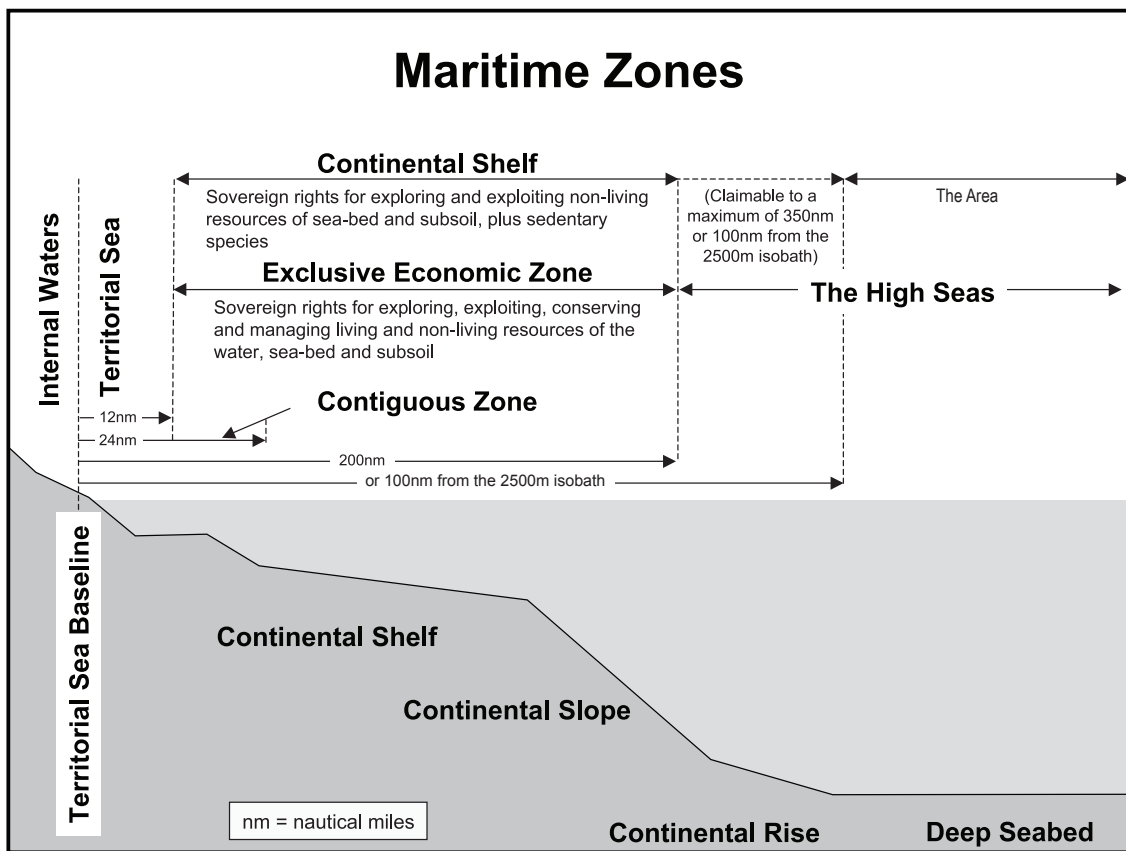

Area of Application of Canada's Oceans Strategy

29 Two main islands, **Graham Island** and **Moresby Island**, are separated by Skidegate Channel. This channel is navigable only by small vessels at high-water slack. Elevations on Haida Gwaii reach 100 m along the east and north coasts of Graham Island and 1 200 m along the west side of Moresby Island.

30 The west coasts of Graham and Moresby Islands are rugged and precipitous with numerous deep indentations. The continental margin, west of Haida Gwaii, has a narrow shelf between 2 and 10 miles wide. The east coast of Moresby Island is a maze of inlets and sounds, all with rocky seaboards and depths of 20 m or more. In contrast, the east coast of Graham Island is almost unbroken with low wooded shores fronted by depths under 20 m up to 23 miles offshore. The north shore of Graham Island is noted for extensive sandy beaches.

Transportation

31 **Sea Transportation.** — Regular worldwide shipping services are maintained between British Columbia and principle ports throughout the world. Freight transportation to

and from northern coastal communities is supported mostly by tugs and barges.

32 **Ferry service** is offered by many companies. British Columbia Ferry Services Inc. (B.C. Ferries) provides passenger and vehicle service for up to 47 ports of call on 25 routes throughout the coast. Washington State Ferries, in the United States, carries passengers, freight and goods to 20 ferry terminals in the Puget Sound area and to Sidney, B.C. Alaska State Ferries provides service to Alaska ports including departures from Prince Rupert, B.C. and Bellingham, WA.

33 **Rail Transportation.** — Transcontinental freight transportation is provided by Canadian National Railway Company and Canadian Pacific Railway. Privately owned companies serve the lower mainland and western states of Washington, Oregon and California.

34 Passenger rail service is operated by VIA Rail Canada Inc. on the mainland and by E&N Railway Company (RailAmerica) on Vancouver Island.

35 Ocean terminals for mainland freight railways are located in Vancouver, New Westminster, Squamish, Prince Rupert and Kitimat. On Vancouver Island, the railroad follows the southeast coast from Victoria to Courtenay. It also cuts across Vancouver Island to reach Port Alberni, but this line

is currently out of use. Railway facilities are at the shipping ports of Nanaimo and Port Alberni.

36 Northern British Columbia is served by Canadian National Railways with an ocean terminal at Prince Rupert. Passenger service is provided by VIA Rail. A branch line connects Kitimat with the main line running to Prince Rupert.

37 **Road Transportation.** — North of Bliss Landing, on the mainland, there are no roads leading to or along the coast. Local and secondary roads south of Bliss Landing are connected by ferries that cross the entrances of Jervis Inlet and Howe Sound. A coastal road from North Vancouver leads along the east side of Howe Sound to Squamish.

38 The main north/south highway on Vancouver Island runs between Victoria and Port Hardy. Local roads lead to the communities of Coal Harbour, Holberg and Winter Harbour. Near Nanaimo, the Inland Island Highway provides an alternate north/south route for high-speed and commercial truck traffic. A highway crosses Vancouver Island between Nanaimo and Port Alberni, continues west from Port Alberni and connects to Tofino and Ucluelet on the west coast. Other roads that cross Vancouver Island terminate in Port Alice and Gold River. A coastal road along the southwest side of Vancouver Island connects Victoria to Port Renfrew.

39 The main north/south highway in northern British Columbia is located approximately 500 km inland. Roads connecting to the main highway system reach the coast at Bella Coola, Kitimat, Prince Rupert, Kitsault and Stewart. The road between Bella Coola and Williams Lake, 480 km inland on the north/south highway, has a partly gravel surface.

40 Main highways from Kitimat and Prince Rupert join at Terrace — on the Skeena River — and then lead 580 km east to Prince George on the north/south highway. A paved road leads south from Stewart, connecting with the main highway joining Terrace and Prince George. A partly gravel road also leads north from Stewart and connects with the main Alaska Highway at the British Columbia/Yukon border.

41 The public highway on Haida Gwaii is mainly confined to Graham Island. It connects Masset at the north end to the village of Queen Charlotte at the south end. A ferry connects this highway with Alliford Bay, at the north end of Moresby Island. A short length of public highway connects Alliford Bay to Sandspit.

42 **Air Transportation.** — International passenger and cargo air services operate from Vancouver International Airport, Abbotsford International Airport, Victoria International Airport, Kelowna International Airport, and Prince George Airport. Domestic air services connect all principal towns on the mainland and between the mainland,

Vancouver Island and Haida Gwaii. Charter aircraft are available in most areas. Many coastal communities without airports are served by scheduled and chartered floatplane flights. Airport locations and heliports at hospitals are listed below.

43 **Sea-plane landing areas** are located in most major harbours and in numerous other areas along the coast. They are listed in the geographical books of Sailing Directions.

Airports near the coast

Airport	Position
Vancouver	49°11'N, 123°11'W
Victoria	48°39'N, 123°25'W
Nanaimo	49°03'N, 123°52'W
Comox	49°43'N, 124°53'W
Campbell River	49°57'N, 125°16'W
Port Hardy	50°41'N, 127°22'W
Tofino	49°05'N, 125°46'W
Prince Rupert	54°17'N, 130°27'W
Terrace (64 km inland from Kitimat)	54°28'N, 128°35'W
Sandspit	53°15'N, 131°49'W

Airports with paved runways

Airport	Position
Abbotsford	49°01'N, 122°22'W
Alert Bay	50°35'N, 126°55'W
Bella Bella (Campbell Island)	52°11'N, 128°09'W
Bella Bella (Denny Island)	52°08'N, 128°04'W
Bella Coola	52°23'N, 126°36'W
Boundary Bay	49°04'N, 123°00'W
Courtenay	49°41'N, 124°59'W
Duncan	48°45'N, 123°43'W
Gibsons-Sechelt	49°28'N, 123°43'W
Langley	49°06'N, 122°38'W
Masset	54°01'N, 132°07'W
Pitt Meadows	49°13'N, 122°43'W
Port Alberni	49°15'N, 124°50'W
Port McNeil	50°34'N, 127°01'W
Powell River	49°50'N, 124°30'W
Qualicum	49°20'N, 124°25'W
Squamish	49°47'N, 123°10'W
Stewart	55°56'N, 129°59'W
Texada (Gillies Bay)	49°42'N, 124°31'W

Aircraft landing strips with unpaved runways

Airport	Position
Delta	49°05'N, 122°56'W
Fort Langley	49°10'N, 122°33'W
Hope	49°22'N, 121°29'W
Kitimat	54°10'N, 128°35'W

Heliports at hospitals

Heliport	Position
Campbell River	50°00'N, 125°14'W
Comox	49°40'N, 124°56'W
Ganges	48°51'N, 123°31'W
Hope	49°22'N, 121°25'W
Kitimat	54°03'N, 128°39'W
Mission	49°08'N, 122°20'W
Nanaimo	49°11'N, 123°58'W
Port Alberni	49°15'N, 124°49'W
Port Alice	50°26'N, 127°29'W
Port Hardy	50°43'N, 127°30'W
Port McNeill	50°35'N, 127°04'W
Prince Rupert	54°18'N, 130°20'W
Sechelt	49°28'N, 123°45'W
Tofino	49°09'N, 125°54'W
Victoria	48°26'N, 123°19'W
Vancouver	49°16'N, 123°14'W

Communications

44 **Radio.** — In addition to facilities provided by Coast Guard Marine Communications and Traffic Services (MCTS), there are ship-to-shore radiotelephone connections through TELUS. Facilities at Victoria MCTS permit connection between ships and the shore telephone system by means of duplex equipment. Smaller and more isolated communities along the coast are equipped with telephone or radiotelephone. Government and private broadcasting throughout the province is available and the number of facilities is increasing. See *Radio Aids to Marine Navigation (Pacific and Western Arctic)*.

45 **Telephone** services in British Columbia are comprehensive and most areas have telephone communications. Microwave equipment has been used to extend services to more remote locations. There is direct cable connection between Vancouver Island, the Gulf Islands, Haida Gwaii and the mainland. Transpacific cables to New Zealand and Australia start at Port Alberni.

46 **Cell phone** coverage in British Columbia is dependent upon handset type and software release. Coverage is good in populated areas, but limited elsewhere. The west coast of Vancouver Island has coverage only in the vicinity of Tofino and Ucluelet. Between Port Hardy and Prince Rupert and in remote mainland inlets there is little or no coverage.

47 **Caution.** — **Cell phones should not be used as a substitute for VHF radios. In an emergency situation a VHF radio can be used to help locate a vessel in trouble by direction finding (DF). This cannot be done with a cell phone.**

Vessel Traffic Services (VTS)

48 **How VTS Operates.** — Ships are required to obtain VTS clearance prior to beginning a voyage in Canadian waters or when entering from seaward. This clearance is issued by a Marine Communication Officer (MCO) after screening information about identity, condition, cargo and intentions of the vessel. As it proceeds on its voyage the ship is required to maintain a listening watch on designated marine VHF radio channels and report at calling-in points (see diagrams in the *Radio Aids to Marine Navigation (Pacific and Western Arctic)*). In turn, the vessel is provided with information, advice and sometimes directions pertaining to other marine traffic, as well as navigational safety and weather information.

49 In many places, traffic routing systems have been established to further enhance vessel movement and safety. These consist of “one way” lanes and separation zones and are shown on nautical charts. A Tanker Exclusion Zone (TEZ) off the West Coast applies to tankers carrying crude oil from Alaska in the Juan de Fuca Strait. Movement Restriction Areas (MRAs) wherein local safety regulations apply have been established by legislated authority. The MCTS officers monitor and enforce compliance within these systems.

50 **Vessel Traffic Services (VTS)** systems have been instituted in two zones:

1. Prince Rupert Traffic Zone
2. Vancouver Traffic Zone

Refer to http://www.pacific.ccg-gcc.gc.ca/mcts-sctm/tofino/index_e.htm for more information.

51 Vessels approaching the West Coast on a North Pacific great circle route or approaching from the south along the United States coastline will first enter an area of responsibility of the **Prince Rupert Traffic Zone**. Radar coverage from Mount Ozard extends seaward for more than 90 kilometres.

52 The **Vancouver Traffic Zone** includes waters from the northern tip of Vancouver Island down the Queen Charlotte Strait and the Strait of Georgia to Victoria. The Vancouver Zone is divided up into four sectors, all the responsibility of Victoria MCTS Centre.

53 Ships transiting the Vancouver Zone use nine remote VHF radio sites. Vessels in the heavily traveled Gulf Islands and Strait of Georgia areas are tracked by shore based radar installations located at Mount Helmcken near Victoria, Mount Newton in Saanich, Bowen Island, Mount Parke on Mayne Island microwaved to the centre in Victoria, as well as radar located in West Vancouver and Berry Point above the Second Narrows in Vancouver Harbour.

54 Vessels approaching the West Coast bound for ports of Prince Rupert and Kitimat will enter an area of responsibility of the **Prince Rupert Traffic Zone**.

- 55 **Participation in VTS Systems is mandatory for:**
- every ship 20 m or more in length;
 - every ship engaged in towing or pushing any vessel or object, other than fishing gear, where:
 - combined length of the ship and any vessel or object towed or pushed is 45 m or more in length;
 - length of the vessel or object being towed or pushed by the ship is 20 m or more in length.

Regulations do not apply to:

- a ship towing or pushing any vessel inside a log booming ground;
 - a pleasure yacht less than 30 m in length;
 - a fishing vessel less than 24 m in length and not more than 150 tons gross.
- 56 Permission to hold a regatta, marine parade or race should be requested from Victoria Traffic or Prince Rupert Traffic. Marine Communications and Traffic Services (MCTS) Centre will then inform other mariners of such activities. The course or route of a regatta, marine parade or race should not intersect with established traffic routes without prior authority from the appropriate MCTS Centre.

57 **Cooperative Vessel Traffic Services (CVTS).** — The United States Coast Guard operates the Puget Sound VTS system, Seattle Traffic, from Seattle, Washington. A cooperative Vessel Traffic Services (CVTS) Agreement exists between Canada and the U.S. As part of the Agreement, Prince Rupert Traffic provides VTS for the offshore approaches to Juan de Fuca Strait and along the Washington State coastline from 48°N. Seattle Traffic provides VTS for both Canadian and American waters of Juan de Fuca Strait and Victoria Traffic provides VTS for both Canadian and American waters of Haro Strait, Boundary Passage, and southern Strait of Georgia.

58 A freighter will be provided with many VTS services on a typical voyage from Japan to Vancouver. It will obtain clearance from CVTS Offshore. When the freighter arrives within 50 nautical miles of Vancouver Island, Prince Rupert Traffic will communicate with the ship using one of several remote VHF sites and track the vessel on radar into Juan de Fuca Strait. Seattle Traffic will monitor the ship's movement from four remote radars as it passes through Juan de Fuca Strait. The last six hours of its trip will be monitored by Victoria Traffic using five remote radar/VHF sites.

59 **Canadian Coast Guard** has MCTS Centres at:

- Sidney (*48°39'04"N, 123°26'47"W*) **Victoria Traffic;**
- Prince Rupert (*54°17'51"N, 130°25'06"W*) **Prince Rupert Traffic.**

60 **United States Coast Guard** has a VTS Centre in Seattle that is identified as Seattle Traffic.

61 These MCTS Centres are equipped with VHF transmitting and receiving facilities both locally and from remote sites. Except for Prince Rupert they are equipped with radar.

62 **Geographical limits** of traffic zones are fully described in *Radio Aids to Marine Navigation (Pacific and Western Arctic)*.

64 **Seattle Traffic Zone** is all Canadian and American waters, in Juan de Fuca Strait, between longitude *124°40'W* and a line from Church Point to Race Rocks light to the intersection of the Canada/U.S. border at *48°17'06"N, 123°14'51"W*, then NE to Hein Bank light buoy, then to Cattle Point light. **This zone is administered by Seattle Traffic; assigned frequency is Channel 5A (156.25 MHz).**

65 **Victoria Traffic Zone** is Canadian waters east of Vancouver Island. It is divided into four sectors:

66 **Sector One** is all Canadian and American waters in Juan de Fuca Strait north of the line defining the east boundary of the area administered by Seattle Traffic. It also includes Canadian and American waters in Haro Strait, Boundary Pass and the south part of the Strait of Georgia. North limit of Sector One is a line joining Reception Point light (*49°28'15.9"N, 123°53'12"W*) to Merry Island light, to Ballenas Islands light to Cottam Point (*49°18'57"N, 124°12'45"W*). **This sector is administered by Victoria Traffic call sign VAK, assigned frequency is Channel 11 (156.55 MHz).**

67 **Sector Two** is waters of the south or main arm of Fraser River east of Sand Heads light (*49°06'23"N, 123°18'04"W*), to a line running 090° from Shoal Point (*49°11'45"N, 122°54'51"W*) to the south shoreline. **This sector is administered by Victoria Traffic call sign VAK, assigned frequency is Channel 74 (156.725 MHz).**

68 **Sector Three** is Canadian waters north and east of a line from Iona Breakwater light (*49°12'18"N, 123°15'50"W*), then 270°, 6.6 miles to *49°12'18"N, 123°25'53"W*, then 000°, 8.15 miles to Cape Roger Curtis light (*49°20'24"N, 123°25'53"W*), then 303°, 4.8 miles to Gower Point (*49°23'01"N, 123°32'06"W*), including all the waters of Howe Sound and Burrard Inlet. **This sector is administered by Victoria Traffic call sign VAK, assigned frequency is Channel 12 (156.6 MHz).**

69 **Sector Four** is Canadian waters bounded on the south by a line from Reception Point light (*49°28'15.9"N, 123°53,12"W*) to Merry Island light (*49°28'03.5"N, 123°54'40"W*) to Ballenas Islands light (*49°21'02"N, 124°09'32"W*) to Cottam Point (*49°18'57"N, 124°12'45"W*), and bounded on the north by a line from Cape Sutil (*50°52'34"N, 128°03'07"W*) to Mexicana Point (*50°54'52"N, 127°59'58"W*) to Cape Caution light (*51°09'49"N, 127°47'12"W*). **This sector is administered by Victoria Traffic call sign VAK, assigned frequency is Channel 71 (156.575 MHz).**

70 **Prince Rupert Traffic Zone** is Canadian waters of the west coast of Vancouver Island to the limit of the Territorial Sea, including Barkley Sound and Alberni Inlet but excluding the inside waters of other inlets. Then following the limit of

the Territorial Sea up to the British Columbia/Alaska boundary in Dixon Entrance. The zone is divided into two sectors with sector one further divided into a north and south zone.

71 **Sector One North** is all Canadian waters north of Vancouver Island between a line joining Cape Caution light (*51°09'49"N, 127°47'12"W*) to Mexicana Point (*50°54'52"N, 127°59'58"W*) thence to Cape Sutil (*50°52'34"N, 128°03'07"W*) and the British Columbia/Alaska border, excluding waters in Sector Two. **This sector is administered by Prince Rupert Traffic call sign VAJ, assigned frequency is Channel 11 (156.55 MHz).**

71.1 **Sector One South** is Canadian waters of the west coast of Vancouver Island to the limit of the Territorial Sea, bounded on the north by a line joining Cape Scott to Triangle Island. This includes Barkley Sound and Alberni Inlet, but excludes the inside inlets of other inlets. **This zone is administered by Prince Rupert Traffic call sign VAJ, assigned frequency is Channel 74 (156.725 MHz).**

72 **Sector Two** is all Canadian waters bounded by a line running from Bareside Point (*53°54'12"N, 130°16'31"W*) to Swede Point (*53°53'16"N, 130°15'35"W*); then following the northern shoreline of Pitt Island to *53°48'03"N, 129°58'31"W*, then to *53°48'41.4"N, 129°57'07.9"W*; then northward following the mainland shore to *54°09'38"N, 129°57'37"W*, then to *54°11'53"N, 129°58'51"W*; then northward following the mainland shore to *54°37'57"N, 130°26'31"W*, then to *54°38'02"N, 130°26'31"W*; then northward along the west shore of Maskelyne Island to Maskelyne Point (*54°38'55"N, 130°26'42"W*), thence to Wales Point (*54°42'17"N, 130°28'33"W*), then westward along the shore of Wales Island to *54°42'06"N, 130°31'47"W*, then to *54°42'27"N, 130°36'50"W*, then westward along the International Boundary to Cape Muzon light (*54°39'48"N, 132°41'30"W*), then westward along the shore of Dall Island to Point Cornwallis light (*54°42'12"N, 132°52'17"W*), then southward to Langara Point (*54°15'23"N, 133°03'30"W*), thence southward along the west coast of Langara Island to Lacy Island (*54°13'18"N, 133°05'24"W*), then southward to Cape Knox on Graham Island (*54°11'N, 133°05'W*), then eastward along Graham Island shoreline to Rose Spit Racon (*54°11'12.5"N, 131°38'43"W*), then southeastward to Seal Rocks (*54°00'N, 130°47'26"W*), then to Oval Point on Porcher Island (*53°56'24"N, 130°43'15"W*), then eastward following Porcher Island shoreline to Bareside Point. **This sector is administered by Prince Rupert Traffic call sign VAJ, assigned frequency is Channel 71 (156.575 MHz).**

73 A VHF/DF advisory service is available for ships in difficulty from receiver sites located at Mount Hays, Dundas Island, Cumshewa, Van Inlet, Naden Harbour, Barry Inlet, Mt. Gil, Klemtu and Calvert Island. Position and/or bearing and distance information may be provided for use at the discretion of the recipient.

74 **Vessel Traffic Services into Juan de Fuca Strait.** — In accordance with the Canada/United States Co-operative Vessel Traffic System Agreement, when inbound and crossing longitude *127°W*, latitude *48°N*, or within 50 miles of Vancouver Island, all vessels 30 m or greater, including tug and tows, must contact **Prince Rupert Traffic on VHF Channel 74**. After contact has been made vessels will receive instructions on when to switch to frequencies for **Seattle Traffic (VHF Channel 5A)**, and subsequently **Victoria Traffic (VHF Channel 11)**.

75 Participation with Prince Rupert, Seattle and Victoria Traffic is mandatory within Canadian and American territorial waters. Services are available considerably further offshore, typically about 60 miles. Although participation seaward of Canadian and American territorial waters is voluntary, vessels are strongly encouraged to participate to receive the full benefit of available Vessel Traffic Services. These benefits include traffic information, warnings of vessel congestion or other hazardous conditions, and many other forms of transit assistance.

76 Participation under the USCG VTS regulations is mandatory for:

- power driven vessels 40 m or more in length;
- towing vessels 8 m or more in length when towing;
- vessels certified to carry 50 or more passengers when engaged in trade.

77 **English Language Communications in CVTS Area.** — In accordance with the CVTS System Agreement, mariners are cautioned that, as specified in international regulations, requirements and agreements, all communications within the CVTS area must be in clear unbroken English. At least one person capable of conducting clear unbroken two-way radio communication using the English language must be present on the bridge at all times within the CVTS area. This requirement is deemed essential in order to maintain an acceptable level of marine safety within CVTS waters.

78 **Message Markers.** — Should language problems arise, communications may be preceded by the following message markers:

- Question a request for information
- Answer the reply to a previous question
- Request..... a request for action from others with respect to the ship
- Information .observed facts
- Intentionnotice of immediate planned navigational actions
- Warning..... information about dangers
- Advice.....a recommendation to correct a hazardous condition
- Instruction ... a lawful order
- Clearance..... an authorization to proceed subject to conditions

79 **Times** in traffic zones shall be given in Pacific Standard Time (PST, Time Zone +8), or Pacific Daylight Time (PDT), whichever is in effect. PDT is obtained by advancing the clock one hour. The twenty-four hour clock system should be used.

80 **Calling-in points** shown on the diagrams are in the geographical books of Sailing Directions. Mariners should use names assigned to Calling-in points rather than numbers.

81 **Note there is no intention on the part of the Canadian Coast Guard to attempt to navigate or manoeuvre ships from a shore station.**

82 For details on VTS see *Radio Aids to Marine Navigation (Pacific and Western Arctic)*.

83 **Puget Sound Vessel Traffic Service** is mandatory in United States waters of Juan de Fuca Strait east of Port Angeles, and in waters of Rosario Strait, Admiralty Inlet, Puget Sound and navigable waters adjacent to these areas. This service consists of a Vessel Traffic Centre (VTC) that may regulate routing and movement of vessels by radar surveillance, movement reports of vessels, VHF-FM radio communications, and specific reporting points. It also consists of traffic lanes, separation zones and precautionary areas. Complete details are in *United States Coast Pilot 7*.

84 Proper operating procedures are also given in the *Vessel Traffic Service Puget Sound User Manual*, available from:

Commanding Officer, U.S. Coast Guard,
Puget Sound Vessel Traffic Service,
1519 Alaskan Way S.,
Seattle, Washington, U.S.A. 98134-1192
<http://www.uscg.mil/d13/units/vts/psvts.html>

85 **Regional Marine Information Centre (RMIC)** is the information clearinghouse for the Pacific Region. Items include pollution reports, shipping information, after hours call outs for other government agencies and Notices to Shipping. The RMIC (like MCTS in general) is a 24 hour a day operation that is unique in Western Canada.

86 An average day in the RMIC involves fielding calls from the general and maritime public for shipping information for the West Coast and the Port of Vancouver in particular, to report pollution and navigational hazards and calls requesting tide and weather information. Some of the government agencies that the RMIC liaises with are the Port of Vancouver, Transport Canada Marine Branch, Fisheries and Oceans Canada Radio Room, Environment Canada – Environmental Protection Branch and the Provincial Emergency Program, Canada Customs and Agriculture Canada, the U.S. Coast Guard, VTS and various Canadian and U.S. naval groups.

87 Typically, most of the government agencies have ‘requests to be alerted’. Some agencies need to know in advance when a ship will be coming into Canadian waters; others need to be alerted both during office and after hours in response to

calls from ships agents, other government agencies and the general public.

88 The RMIC is the collector and disseminator of marine pollutant spills reports or land/air based spills that affect the coast. Spill reports are normally received via phone (pollution line 1-800-889-8852 or via 666-6011, 12, 13 or 14) or in the case of PEP and EPS, via fax. The reports are entered into the pollution database and the relevant authorities are called/paged and faxed.

Border Crossing

89 **Customs Reporting Requirements.** — *Customs Act and Regulations* require that the Master of each vessel arriving from a foreign port or place report immediately, on arrival in Canada, to Canada Customs. The Master only is permitted to go ashore to make the report and then must return to the vessel until inspection is completed. All passengers, merchandise and baggage must be held onboard until released.

90 “Arriving from a foreign port or place” means “touching” in one or more of the following manners:

- (1) anchoring in foreign waters;
- (2) coming alongside a dock in foreign waters;
- (3) contacting a hovering vessel.

91 Failure to comply with Customs law could result in penalties or seizure of the vessel.

92 Where bad weather or other emergency forces a landing at a port that has no Customs service, it is your obligation to telephone the nearest Regional Customs Office, or the nearest office of the Royal Canadian Mounted Police, to report the circumstances of your arrival.

93 **Recreational Boats.** — The Master of a recreational boat is the person in charge. As Master of the recreational boat, you are required to go to a designated telephone reporting marine site and call the telephone reporting centre at 1-888-226-7277. No one except the Master may leave the boat until authorization is given by customs. The Master also has to follow these steps:

- give the full name, date of birth, and citizenship for every person on the boat;
- give the destination, purpose of trip, and length of stay in Canada for each passenger who is a non-resident of Canada;
- give the length of absence for each passenger who is a returning resident of Canada;
- give the passport and visa information of passengers, if applicable;
- make sure all passengers have photo identification and proof of citizenship documents;
- declare all goods being imported, including firearms and weapons;

- report all currency and monetary instruments of a value equal to or greater than CAD\$10 000;
- for returning resident of Canada, declare all repairs or modifications made to goods, including the boat, while outside of Canada;
- give true and complete information.

94 As proof of presentation, the customs officer will give the Master a report number for the records. The Master has to give this number to a customs or immigration officer upon request.

95 Depending on the severity of the violation, the Canada Border Service Agency (CBSA) can impose penalties and seize any goods and any boat used to carry the goods. As well, you may be subject to criminal prosecution.

96 **Import Restrictions.** — All travellers can import goods for their personal use. United States residents must return all goods to the United States unless those goods were consumed while in Canada.

97 **If you import any promotional materials**, including samples, commercial goods, or equipment, you have to clear your importations through a commercial broker, pay duties and taxes, or provide security, as required.

98 **You cannot import controlled, restricted, or prohibited animals, plants, or goods** as described in the publications for Canadian residents called I Declare, or in Customs Information for Visitors to Canada and Seasonal Residents, for United States residents.

99 **There are restrictions on importing alcohol and tobacco products into Canada.** For more information, see the publications called I Declare, or Customs Information for Visitors to Canada and Seasonal Residents.

100 **You cannot import prohibited firearms or weapons** including Mace, pepper spray, and stun guns. If you plan to import firearms or weapons, for hunting or for a competition for example, read and follow the procedures stated in the publication called Importing a Firearm or Weapon into Canada.

101 Controlled, restricted, or prohibited goods will be seized and you may be subject to criminal prosecution.

102 **Penalties.** — You will be subject to random examinations to ensure that you comply with customs and immigration legislation as well as any other legislation administered or enforced by the CBSA.

103 Depending on the severity of the violation the CBSA can impose penalties and seize any goods and any aircraft or boat used to carry the goods. As well, you may be subject to criminal prosecution.

104 Citizenship and Immigration Canada can arrest and remove non-residents of Canada for violations of the Immigration and Refugee Protection Act.

105 **CANPASS Private Boat Program** is a result of the Canada-United States Accord on Our Shared Border. The ac-

cord sets out initiatives to promote trade, tourism, and travel between the two countries. If you often enter Canada from the United States using a private pleasure boat, CANPASS – Private Boat may be for you. Private Boat program members may call up to four hours in advance to report their estimated arrival time in Canada and then arrive at a telephone reporting marine site.

106 **You may qualify to participate** in the program if you are a citizen or permanent resident of Canada or a citizen or resident alien of the United States. However, you will not qualify for CANPASS – Private Boat membership if you:

- provide false or incomplete information on your application form;
- have been convicted of a criminal offence in any country for which a pardon has not been granted;
- have been found in violation of customs or immigration legislation;
- are inadmissible to Canada under the Immigration and Refugee Protection Act.

107 **How to Apply.** — Your participation in this program is strictly voluntary. If you choose to complete the application form E672, CANPASS Application Form, the information you provide will be used to determine your eligibility. If you are accepted into the program, your membership will be valid for five years. Complete and sign the application form and send it, with a non refundable five year processing fee of CAN\$40 for each applicant 18 years or older, to:

Customs Processing Centre
28-176th Street
Surrey B.C. V3S 9R9
Telephone: (604) 535-9346

108 **CANPASS Presentation and Reporting.** — The Master is the person in charge of the boat and it is through the Master that CANPASS – Private Boat members must present themselves and report goods. Masters are responsible for presenting themselves, their crew, and passengers by:

- calling 1-888-CANPASS (226-7277) up to four hours before arriving in Canada;
- giving the estimated time of arrival (ETA);
- calling 1-888-CANPASS again to report any change in the ETA, point of arrival, or other information;
- giving the name and registration number of the boat;
- giving the full name, date of birth, and citizenship for all persons on board the boat;
- giving the destination, purpose of trip, and length of stay in Canada for each passenger who is a non-resident of Canada;

- giving the length of absence for each passenger who is a returning resident of Canada;
- giving the passport and visa information of passengers (including members of the crew), if applicable;
- making sure all passengers have photo identification and proof of citizenship documents;
- declaring all goods being imported, including firearms and weapons;
- reporting all currency and monetary instruments of a value equal to or greater than CAD \$10,000;
- for returning residents of Canada, declaring all repairs or modifications made to goods (including the boat) while outside of Canada;
- giving true and complete information.

109 As proof of presentation, the CBSA officer will give the Master a report number. The Master has to give this number to a CBSA officer upon request.

110 If a CBSA officer is not there to meet the boat when it arrives at the reported ETA or actual time of arrival (whichever is later), the Master may then proceed to the boat's final Canadian destination.

111 **CANPASS Responsibilities.** — As a CANPASS Private Boat member, whether you are the person in charge of the boat, a member of the crew or a passenger, you must:

- show your CANPASS – Private Boat authorization, personal identification (original documents), and any required immigration documents to a CBSA officer upon request;
- not transfer your CANPASS – Private Boat privileges, identification, or documents;
- follow all the rules and requirements listed in this brochure and in the CANPASS – Private Boat Participant's Guide, and all the terms and conditions set out on your CANPASS – Private Boat authorization.

112 **Penalties.** — Even if it is determined that you are a low risk traveller and you are granted CANPASS – Private Boat membership, you continue to be subject to random examinations to ensure that you comply with the terms and conditions of the CANPASS – Private Boat program as well as any other legislation administered or enforced by the CBSA.

113 Your membership can be revoked or suspended if you fail to comply with the requirements and procedures of the CANPASS – Private Boat program. This includes non compliance with customs and immigration legislation or any other laws the CBSA administers.

114 Depending on the severity of the violation, the CBSA can impose penalties and seize any goods and any boat used to carry the goods. As well, you may be subject to criminal prosecution.

115 The CBSA will also enforce violations of the Immigration and Refugee Protection Act for CANPASS members who are not citizens of Canada.

116 **Ports of entry** into British Columbia are:

Port	Position
Bedwell Harbour, South Pender Island (May 1 – Sept 30 only)	48°45'N, 123°14'W
Campbell River	50°01'N, 125°15'W
Nanaimo	49°10'N, 123°56'W
Prince Rupert	54°18'N, 130°21'W
Sidney	48°40'N, 123°24'W
Steveston	49°07'N, 123°11'W
Ucluelet	48°57'N, 125°33'W
Vancouver	49°18'N, 123°08'W
Victoria	48°25'N, 123°22'W
White Rock	49°01'N, 122°48'W

117 **CANPASS Ports of Entry** into British Columbia are:

Port	Position
Cabbage Island	48°48'N, 123°05'W
Galiano Island (Montague Harbour)	48°54'N, 123°24'W
Mayne Island (Horton Bay)	48°50'N, 123°15'W
North Pender Island (Port Browning)	48°46'N, 123°15'W
Saltspring Island (Ganges)	48°51'N, 123°30'W

118 For more information on border crossing in Canada consult: <http://www.cbsa-asfc.gc.ca/menu-e.html>

119 For more information on border crossing in the United States consult: <http://www.cbp.gov/>

Security

120 **Security measures** have increased dramatically since the terrorist attacks in 2001. Some of the measures that concern mariners are listed below. For more information on security measures in Canada consult: <http://www.pco-bcp.gc.ca/default.asp?Language=E&Page=PCOsSecretariats&Sub=si>. For more information on security in the United States consult: <http://www.dhs.gov/dhspublic/index.jsp>.

121 **America's Waterway Watch Program** has been established to encourage anyone on or near the water to be aware of suspicious activity that might indicate threats to security. Anyone observing suspicious activity is asked to note details and contact the National Response Center at

1-877-24-WATCH or 1-800- 424-8802. In the case of immediate danger call local authorities at 911 or contact Coast Guard on VHF Channel 16. Do not approach or challenge anyone acting in a suspicious manner. For more information see the America's Waterway Watch Program at <http://www.americaswaterwaywatch.org/>.

122 In Canada, the Royal Canadian Mounted Police (RCMP) administers the **Coastal/Airport Watch Program** for the purpose of identifying persons, vessels, vehicles and aircraft that may pose a threat to Canada's national security, or that may be involved in illegal activities such as drug importation. Members of the public are encouraged to report suspicious activities to the police. In British Columbia, contact the Coastal/Airport Watch Program at 1-888-855-6655. For more information on the program please see the RCMP Coastal/Airport Watch Program web site at http://www.rcmp-grc.gc.ca/caw/index_e.htm.

123 **Marine Transportation Security Regulations** came into effect in July 2004. Regulations apply to vessels in Canada and Canadian ships outside Canada that are SOLAS ships or non-SOLAS ships.

124 A "**SOLAS ship**" means a vessel that:

- (a) is 500 tons gross tonnage or more or is carrying more than 12 passengers;
- (b) is engaged on a voyage from a port in one country to a port in another country other than a voyage solely on the Great Lakes and the St. Lawrence River as far seaward as a straight line drawn from Cap des Rosiers to West Point, Anticosti Island, and from Anticosti Island to the north shore of the St. Lawrence River along the meridian of longitude sixty-three degrees west.

125 A "**non-SOLAS ship**" means a vessel that is not a SOLAS ship, is engaged on a voyage from a port in one country to a port in another country and:

- (a) is more than 100 tons gross tonnage, other than a towing vessel;
- (b) carries more than 12 passengers;
- (c) is a towing vessel engaged in towing a barge astern or alongside or pushing ahead, if the barge is carrying certain dangerous cargoes.

126 Any vessel meeting the above criteria must submit a security plan to Transport Canada for approval. Upon approval and implementation of the plan the vessel will be issued a Ship Security Certificate. Failure to comply with the Marine Transportation Security Regulations could result in denial of entry into Canadian waters or other legal sanction.

127 All facilities that service such vessels are also required to be compliant with the Marine Transportation Security Regulations. Names and locations of such facilities can be found at: <http://www2.imo.org/ISPSCode/ISPSPort-Facilities.aspx>.

128 For more information with regard to compliance requirements of the Marine Transportation Security Regulations contact the Duty Security Inspector at 1-902- 427-8000.

129 **Pre-Arrival Information Report (PAIR)**. — Vessels inbound to Canadian waters on the West Coast shall send a PAIR to the Canadian Coast Guard Regional Marine Information Centre (RMIC) via one of the following methods below:

- if the duration of the segment of the voyage before entering Canadian waters is less than 24 hours, the PAIR shall be submitted as soon as practicable before entering Canadian waters but no later than the time of departure from the last port of call;
- if the duration of the segment of the voyage before entering Canadian waters is less than 96 hours but more than 24 hours, the PAIR shall be submitted at least 24 hours before entering Canadian waters.

Contact:

E-Mail: rmic-pacific@pac.dfo-mpo.gc.ca

INMARSAT: telex 04352586 "CGTC VAS VCR"

Any Canadian Coast Guard MCTS Centre, free of charge; or directly to CVTS Offshore by fax: (604) 666-8453.

For more information see *Radio Aids to Marine Navigation (Pacific and Western Arctic)*.

130 **Automatic Identification System (AIS)**. — Effective April 1, 2005 all vessels over 300 gross tons bound for an American port must be equipped with AIS. Any vessels without AIS capability must request a letter of deviation from the Captain of the port of entry prior to entry and have AIS operational prior to departure.

131 **Security zones around vessels** have been established by a number of different authorities. Within the waters of Puget Sound and adjacent waters the United States Coast Guard has established a temporary moving security zone of 500 yards surrounding passenger vessels. All vessels within this zone shall operate at the minimum speed necessary to maintain a safe course and shall proceed as directed by the Official Patrol or the Passenger vessel Master. No vessels will be allowed to transit this area without permission.

132 In **Alaska** a similar 100 yard security zone has been established around and under all escorted high capacity passenger vessels.

133 The **Port of Vancouver** has established a 100 m security zone around all military vessels in the Port of Vancouver. Any vessel wishing to come within the 100 m security zone shall obtain permission from the Vancouver Harbour Authority.

134 **Caution**. — It is strongly recommended to give all vessels and particularly passenger and military vessels

as wide a berth as possible. Any potentially threatening manoeuvres such as heading directly toward a vessel at high speed should be avoided.

135 **Controlled Access Zones** have been established by a number of different authorities particularly around military facilities or highly vulnerable facilities. In British Columbia waters Controlled Access Zones have been established at the following locations:

- DND jetty, Pedder Bay
- CFB Esquimalt
- DND facilities, Nanoose Bay

For further information see *Notices to Mariners 1 to 46 Annual Edition*.

136 **Ballast water** has been associated with the unintentional introduction of a number of organisms in Canadian waters and several have been extremely harmful to both the ecosystem and the economic well-being of the nation. Ballast waters taken on in areas outside waters under Canadian jurisdiction should not be discharged in waters under Canadian jurisdiction, unless one of the ballast water management options has been successfully performed. With exception of vessels not destined for a Canadian port, the Master of the vessel shall provide a fully completed ballast water report form by facsimile transmission, or by other means as approved by the appropriate marine communications and traffic services (MCTS) officer. For more information please see <http://www.tc.gc.ca/MarineSafety/tp/Tp13617/menu.htm>.

Regulations

137 **Regulations.** — Some of the regulations that concern mariners are listed below. For more information on regulations in Canada consult <http://laws.justice.gc.ca>.

- **Canada Shipping Act**
 - Aids to Navigation Protection Regulations*
 - Air Pollution Regulations*
 - Anchorage Regulations*
 - Boating Restriction Regulations*
 - Charts and Nautical Publications Regulations*
 - Collision Regulations*
 - Competency of Operators of Pleasure Craft Regulations*
 - Crewing Regulations*
 - Dangerous Goods Shipping Regulations*
 - Garbage Pollution Prevention Regulations*
 - Minor Waters Order*
 - Oil Pollution Prevention Regulations*
 - Pleasure Craft Sewage Pollution Prevention Regulations*
 - Pollutant Substances Prevention Regulations*
 - Safety Management Regulations*
 - Shipping Casualties Reporting Regulations*
 - Small Vessel Regulations*

- Vessel Traffic Services Zones Regulations*
- **Canadian Environmental Protections Act**
Ocean Dumping Regulations
- **Criminal Code**
- **Customs Act**
- **Fisheries Act**
Whale-Watching Guidelines
- **Indian Act**
- **International Convention on Civil Liability for Oil Pollution Damage**
- **International Convention for the Protection of Submarine Cables**
- **Migratory Birds Convention Act**
- **Navigable Waters Protection Act**
Navigable Waters Bridges Regulations
- **Oceans Act**
- **Pilotage Act**
Pacific Pilotage Regulations
Pilot Ladder Regulations
- **Quarantine Act**

Routes

138 **Tanker Exclusion Zone (TEZ).** — Loaded crude oil tankers of the Trans Alaska Pipeline System (TAPS) are requested to remain seaward of the Tanker Exclusion Zone (TEZ). The purpose of the TEZ is to keep laden tankers west of the zone boundary in an effort to protect shoreline and coastal waters from a potential risk of pollution. The TEZ is defined as a line joining:

54°00'N, 136°17'W
51°05'N, 132°30'W
48°32'N, 126°30'W
48°32'N, 125°09'W

139 **Area to be Avoided (Washington State).** — Adoption of the Area to be Avoided (ATBA) off the Olympic Coast National Marine Sanctuary originated as a buffer for adrift vessels requiring assistance along the rocky and environmentally sensitive coast. The ATBA, which went into effect in June 1995, advises operators of vessels carrying petroleum and hazardous materials to maintain a 25-mile buffer from the coast. This distance narrows as the vessel traffic lanes converge at the entrance to Juan de Fuca Strait.

140 The IMO-designated ATBA applies to all ships carrying cargoes of oil or hazardous materials and all ships 1 600 gross tons and above solely in transit. These vessels should avoid the area bounded by a line connecting the following positions:

48°23'18"N, 124°38'12"W
48°24'10"N, 124°38'12"W
48°26'09"N, 124°44'39"W

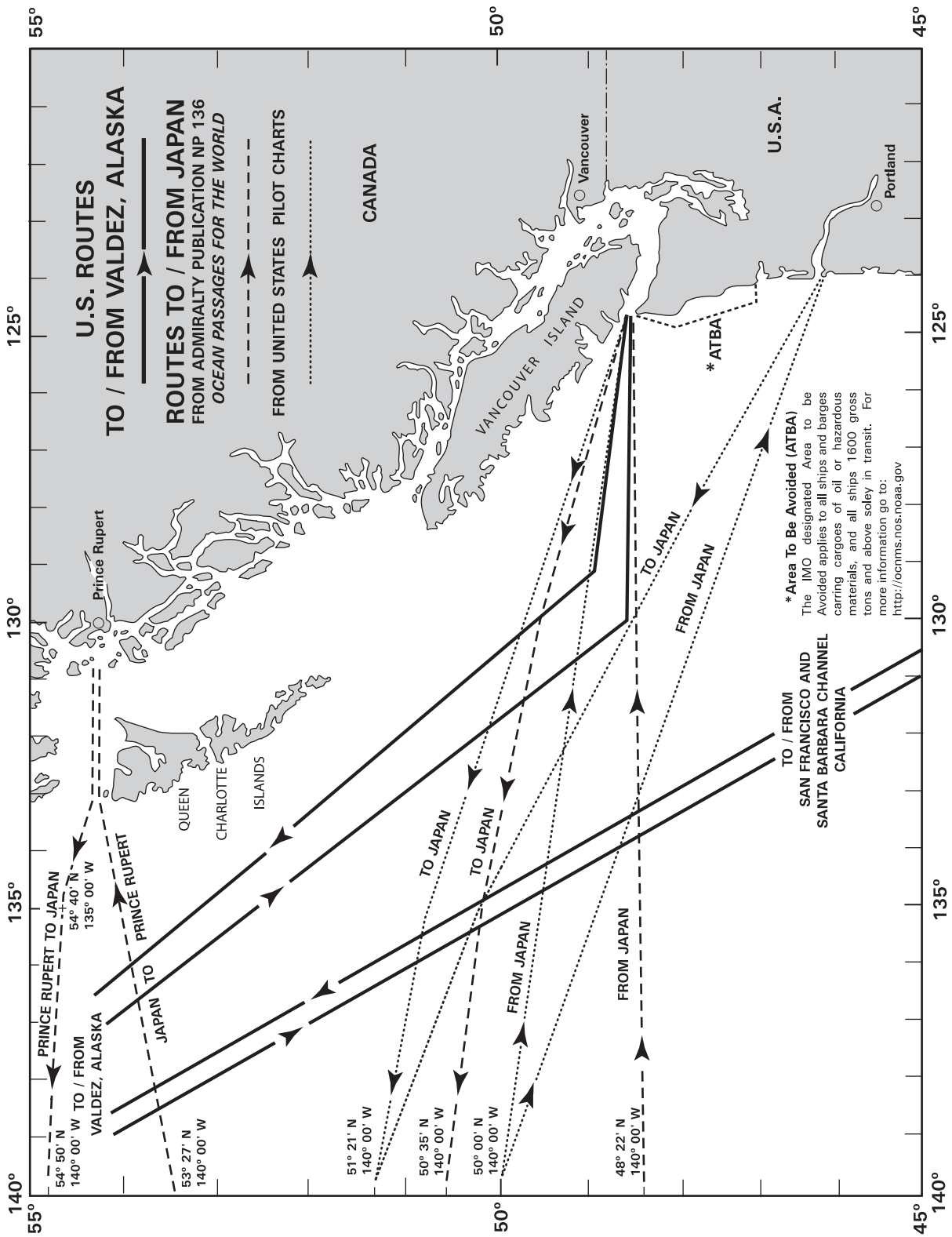

Main Shipping Routes to/from Alaska and Japan

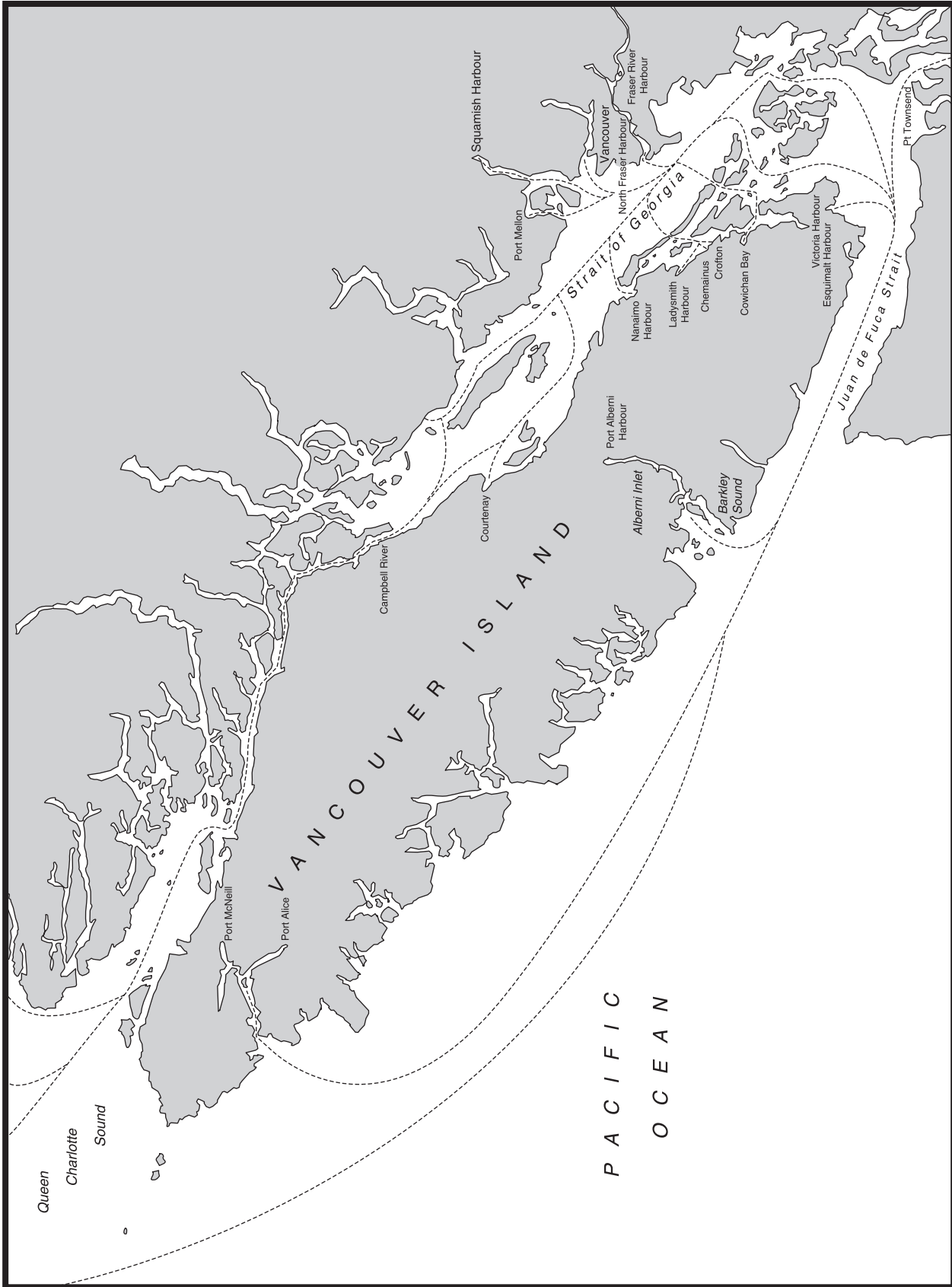

Main Shipping Routes - BC South Coast



Main Shipping Routes - BC North Coast

48°26'09"N, 124°52'48"W
 48°24'40"N, 124°55'42.6"W
 47°51'42"N, 125°15'30"W
 47°07'42"N, 124°47'30"W
 47°07'42"N, 124°11'00"W

141 **Juan de Fuca Strait.** — Principle ocean shipping routes serving southern British Columbia focus at the entrance to Juan de Fuca Strait. Vessels on these routes, except those with very deep draughts, should encounter no shallow water hazards as the offshore banks have relatively deep water over them.

142 La Pérouse Bank, in the NW approach to the strait, extends 35 miles west and 30 miles SW of Cape Beale and has depths of 37 to 100 m. Soquel Bank, off Pachena Point, has depths of 19.2 and 23.4 m. Swiftsure Bank off the entrance to the strait has depths of 34 m.

143 Navigation is simple in clear weather and coasts are well lighted but **owing to the irregularity of currents and tidal streams every precaution should be taken in thick weather.** The strait is subjected to frequent changes of weather – common to these latitudes – and in few parts of the world is more navigational vigilance needed than when entering Juan de Fuca Strait from the Pacific Ocean. A description of the climate of the west coast of Vancouver Island is in Chapter 5 and details of ocean currents, at the west entrance to Juan de Fuca Strait, are in *Canadian Tide and Current Tables, Volumes 5 and 6.*

144 An additional hazard during spring and summer months is the large number of fishing vessels that operate on La Pérouse Bank and in Juan de Fuca Strait. See *Notices to Mariners 1 to 46 Annual Edition.*

145 A Traffic Separation Scheme and Vessel Traffic Services System have been established by the Canadian and United States Coast Guards for Juan de Fuca Strait. Details are in *Radio Aids to Marine Navigation (Pacific and Western Arctic).*

146 The Canadian Forces have a naval base at Esquimalt (48°26'N, 123°27'W) with several firing practice and exercise areas in its vicinity. Details concerning location and operations are given in *Notices to Mariners 1 to 46 Annual Edition* together with other important information for mariners approaching Canadian ports. The Annual Supplement of Temporary (T) and Preliminary (P) Notices and the summary of these notices printed quarterly in monthly *Notices to Mariners*, both published by the Canadian Coast Guard, should be consulted.

147 **Victoria to Vancouver.** — The best route for medium and deep draught vessels is south of Trial and Discovery Islands, through the main channel of Haro Strait and north of Stuart and Skipjack Islands, then through Boundary Pass, west of Patos Island, into the Strait of Georgia.

148 The usual route for coastal or light draught vessels is south of Trial Islands, then by the inshore channels, Mayor and Baynes, passing west of Chain Islets and Chatham Islands, then to the north passing east of Zero Rock and between D'Arcy Shoals and D'Arcy Island, through Sidney Channel and Moresby Passage, through Swanson Channel between North Pender and Prevost Islands, and through either Active Pass or Porlier Pass into the Strait of Georgia. By using this route, weaker tidal streams will be experienced than are found in the Haro Strait route. **This route is not without its hazards as large numbers of pleasure craft, under sail or power, can be encountered mainly during summer months. This is particularly true of Active Pass, which is in regular use by ferries connecting Vancouver Island and the mainland.**

149 A Traffic Separation Scheme and Vessel Traffic Services System have been established by the Canadian and United States Coast Guards for Victoria to Vancouver and include Haro Strait and Boundary Pass. Details are in *Radio Aids to Marine Navigation (Pacific and Western Arctic).*

150 **Vancouver to Queen Charlotte Sound.** — Vessels usually pass north of Ballenas Islands and then through either Stevens Passage or between Sisters Islets and Hornby Island, from where a course is set for Discovery Passage, the only navigable channel from the Strait of Georgia to the NW for large vessels. Vessels may have to wait for slack water in Seymour Narrows for which Menzies and Duncan Bays, south of the narrows, and Plumper Bay to the north, are convenient anchorages.

151 From Seymour Narrows the route passes through Johnstone Strait and the Traffic Separation Scheme at Helmcken Island. The deepest route from Johnstone Strait into Queen Charlotte Strait is through Blackney Passage and Blackfish Sound. The most direct route is through Broughton Strait and its Traffic Separation Scheme into Queen Charlotte Strait.

152 The usual route through Queen Charlotte Strait into Queen Charlotte Sound is through Gordon Channel. An alternative is to follow Goletas Channel as far as Noble Islets then through Christie Passage and Gordon Channel into Queen Charlotte Sound.

153 **The route through Goletas Channel has Nahwitti Bar across its west end. In west gales heavy seas break across this bar.**

154 While several shoals and banks exist along this route even vessels with very deep draughts will have enough sea-room to clear them. Note that it may be necessary in some places to await slack water to avoid the worst effects of strong currents.

155 **The only obstruction likely to limit use of this route is the power line that spans Seymour Narrows. It has a vertical clearance of 55 m.**

156 A series of channels and passages are frequently used by low-powered or small vessels and towboats with rafts to avoid strong tidal streams that funnel through Seymour Narrows. This route begins near Powell River ($49^{\circ}52'N$, $124^{\circ}43'W$) and leads NW through Yuculta Rapids, west through Cordero Channel and then by various routes to Johnstone Strait.

157 **Cape Caution to Alaska.** — A number of different routes and combinations of routes are available. Strong gales may be frequently encountered in Queen Charlotte Sound and Hecate Strait.

158 The **Inside Passage** affords sheltered water with only a few areas exposed to the open ocean. The main route of the Inner Passage, starting from the south, is through Fitz Hugh Sound, Lama Passage, Seaforth Channel, Milbanke Sound, Finlayson Channel, Tolmie Channel, Princess Royal Channel, Grenville Channel, Arthur Passage and Malacca Passage into Chatham Sound.

 159 **Fitz Hugh Sound** can be approached from the south by South Passage or North Passage. **Caution must be used because of numerous offshore rocks, primarily the Sea Otter Group, and also because of frequent occurrence of heavy swell and dense fog.**

160 **Milbanke Sound** is frequently used as an entrance to the Inside Passage from Queen Charlotte Sound.

161 A route used by some vessels to avoid unsheltered waters of Hecate Strait leads from Queen Charlotte Sound into Laredo Sound. It then follows through Laredo Channel, crosses Caamaño Sound, then through Estevan Sound, Principe Channel and Browning Entrance into Hecate Strait.

162 **Vessels bound for Kitimat** ($54^{\circ}00'N$, $128^{\circ}41'W$) approaching from the south usually embark a pilot at Cape Beale ($48^{\circ}47'N$, $125^{\circ}13'W$).

163 The south approach to Triple Islands pilot boarding station is through Queen Charlotte Sound and Hecate Strait. **The latter is relatively confined and shallow at its north end and should be navigated with caution.**

164 **Dixon Entrance.** — North Pacific traffic bound for Prince Rupert or Portland Inlet usually embark a pilot at Triple Islands pilot boarding station ($54^{\circ}18'N$, $130^{\circ}53'W$). Two SE Alaska pilot boarding stations are also approached through Dixon Entrance.

 165 **In some areas strong and uncertain tidal streams and a number of dangers make navigation in Dixon Entrance treacherous in poor visibility.**

 166 **Caution.** — Some minor passages in the inner waters of British Columbia are only roughly examined. Pinnacles of rock and detached boulders from broken shores may exist. Whenever there is a broad and clear channel completely surveyed to modern standards choose this route over a less rigorously surveyed, shorter route.

Pilotage

 167 **Every ship over 350 gross tons is subject to compulsory pilotage.** See *Pilotage Act, Pacific Pilotage Regulations, Section 9* for more details.

168 **Specific circumstances may waive compulsory pilotage:** the ship is in distress, a person onboard requires medical evacuation, the ship is engaged in rescue or salvage operations, the ship is seeking refuge, a licensed pilot is not available, or the ship is warping and is not utilizing its engines or a tug. See *Pilotage Act, Pacific Pilotage Regulations, Section 10* for more details.

169 **Compulsory Pilotage Areas:**

Area 1 — All waters of and all waters flowing into the Fraser River. Also includes all waters of Boundary Bay.

Area 2 — All Canadian waters between Vancouver Island and the mainland. Its southern limit is near the pilot boarding station at the light buoy off Brotchie Ledge near Victoria, and its northern limit at an approximate line between Cape Caution and Cape Sutil on the north end of Vancouver Island.

Area 3 — All Canadian waters on the west coast of Vancouver Island.

Area 4 — All Canadian waters on the mainland north of Vancouver Island.

Area 5 — All Canadian waters in and around Haida Gwaii.

170 Area 4 extends 5 to 15 miles off the east shore and Area 5, 3 to 20 miles off the west shore of Hecate Strait **leaving a channel through Hecate Strait that is not within a compulsory pilotage area.** Area 5 also extends 3 to 5 miles off the west and north shores of Haida Gwaii. See *Pilotage Act, Pacific Pilotage Regulations, Section 3* for more details.

171 **Pilot Dispatch Offices** are located in:

- (a) Victoria
 - Telephone (250) 363-3878 or 1-800-523-8709
 - Fax (250) 363-3293
 - VHF Channel 17 (156.85 MHz);
- (b) Vancouver
 - Telephone (604) 666-6776 or 1-800-663-0407
 - Fax (604) 666-6093
 - VHF Channel 17 (156.85 MHz).

172 **Pilot Boarding Stations** for ships entering compulsory pilotage areas are:

- Adjacent to cautionary light buoy VH, off Brotchie Ledge, Victoria $48^{\circ}21'54"N$, $123^{\circ}23'00"W$;
- Off Cape Beale, at the entrance to Trevor Channel in Barkley Sound $48^{\circ}47'06"N$, $125^{\circ}16'03"W$;
- Off Triple Islands, near Prince Rupert $54^{\circ}18'58"N$, $130^{\circ}53'03"W$;

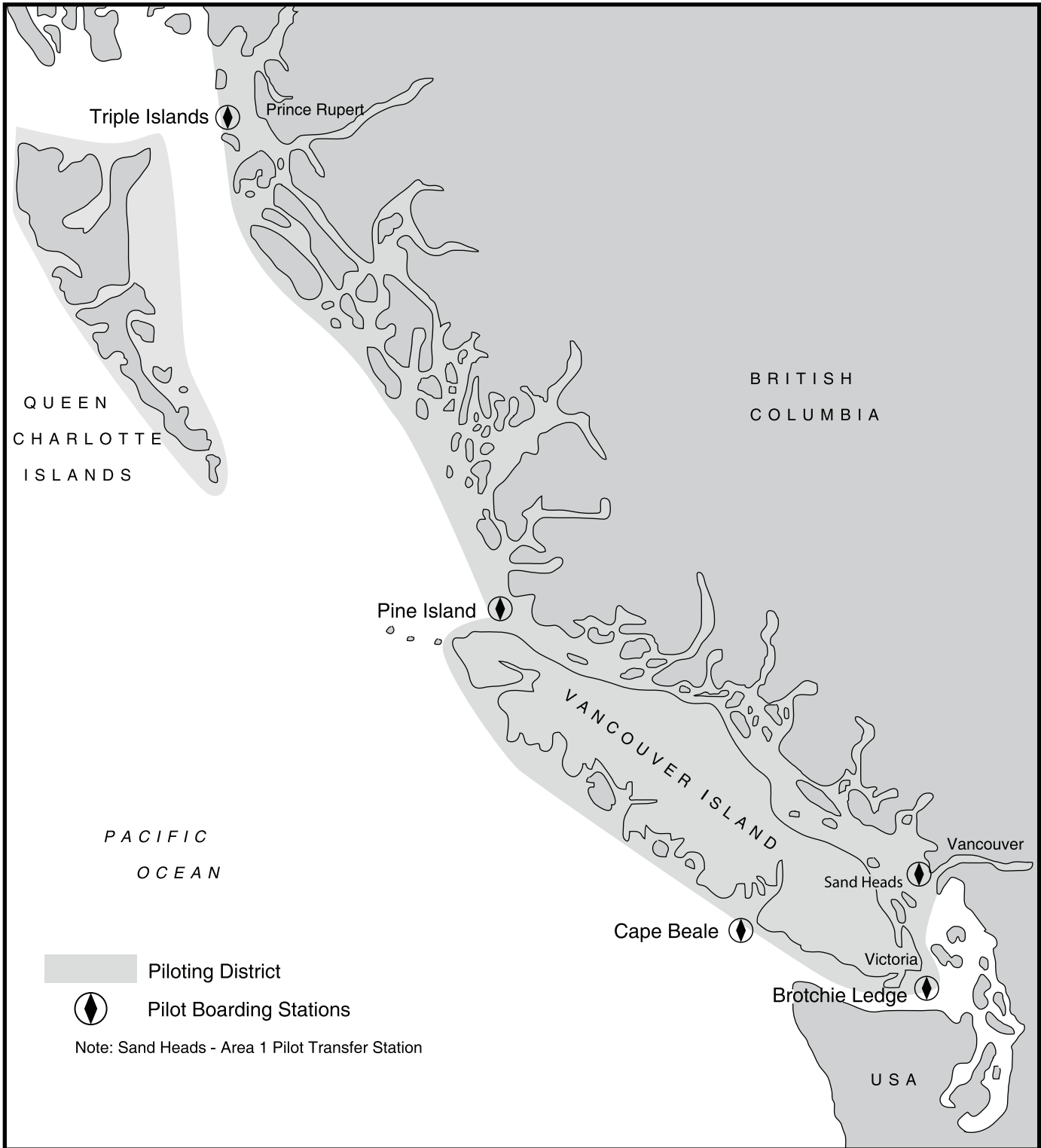

Pilot Boarding Stations

- Off Pine Island, Queen Charlotte Strait (May 1 to October 1) $50^{\circ}59'00''N$, $127^{\circ}48'00''W$;
- Off Sand Heads, at the mouth of the Fraser River, for Area 1 pilot transfers $49^{\circ}04'49''N$, $123^{\circ}20'32''W$;
- At any point or place in the region that the Authority considers necessary to ensure a safe and efficient pilotage service.
- Off Triple Islands, near Prince Rupert helicopter boarding $54^{\circ}19'00''N$, $131^{\circ}02'30''W$;

173 **Pilot Boarding.** — If rough weather at Cape Beale or Triple Islands prevents a pilot from boarding, the vessel should follow the pilot boat into more sheltered waters where embarkation is more practical.

174 In clear weather vessels should indicate their desire for a pilot, by day, by hoisting the International Code flag “G” and, by night, by a signal of four long flashes on their signal lamp. In fog or thick weather vessels should make a whistle signal of four long blasts. A repetition of this signal will assist the pilot-boat in locating the vessel.

175 Pilot-boats do not cruise on station but leave the pilot station onshore, subject to a vessels estimated time of arrival, in ample time to meet it at the boarding station.

176 Attention is drawn to Rule 35(j) of the *Collision Regulations* that reads: “A pilot vessel when engaged on pilotage duty may in addition to the signals prescribed in paragraphs (a), (b) or (g) of this Rule sound an identity signal consisting of four short blasts”. Pilot-vessels on the coasts of Canada adhere to this rule.

177 Pilot-boats are fitted with radar to assist in locating and tracking vessels during periods of low visibility.

178 **Notice to Obtain Pilots Arrivals.** — The Master, Owner or Agent of a ship that is to arrive in a compulsory pilotage area shall notify the Pacific Pilotage Authority of the estimated time of arrival, Co-ordinated Universal Time (UTC), of the ship at the pilot boarding station:

- (a) Victoria cautionary light buoy VH at least 12 hours prior to arrival, and shall confirm or correct the estimated time of arrival not less than 4 hours prior to arrival;
- (b) off Cape Beale at least 48 hours prior to arrival, and shall confirm or correct the estimated time of arrival not less than 12 hours prior to arrival;
- (c) off Triple Islands at least 48 hours prior to arrival, and shall confirm or correct the estimated time of arrival not less than 12 hours prior to arrival;
- (d) at such points or places that the Authority may designate in respect of any ship, at least 48 hours prior to arrival, and shall confirm or correct the estimated time of arrival not less than 12 hours prior to arrival.

179 **Notice to Obtain Pilots.** — **Departures and Movages.** — The Master, Owner or Agent of a ship that is subject to compulsory pilotage shall notify the Pacific Pilotage

Authority at least 12 hours before a pilot is required to be onboard the ship that is to go:

- (a) from one place in a compulsory pilotage area to any other place in a compulsory pilotage area;
- (b) from one place in a compulsory pilotage area to a place outside;
- (c) from a place outside a compulsory pilotage area to any other place.

180 **Pilot order time** may be delayed or cancelled without payment of cancellation fees if notice is received by the Pacific Pilotage Authority not less than:

- (a) six hours prior to transportation in the case of long jobs;
- (b) four hours in the case of Roberts Bank, English Bay, Fraser River Ports, all anchorages and berths east of Berry Point and airports at Vancouver, Victoria and Nanaimo;
- (c) three hours in all other cases.

See *Notices to Mariners 1 to 46 Annual Edition* for more details.

181 **Orders for pilots** must give the following information:

- (a) agency placing order
- (b) agency representative placing order
- (c) place where pilot is to board
- (d) place of destination
- (e) time required
- (f) specific landing instructions, if any
- (g) any other pertinent information e.g. Master’s best estimate of speed or deepest draught for a particular assignment.

182 **Pilotage Messages Arrivals.** — Radio messages from ships requiring pilots shall be addressed to Pilots Victoria and sent via any Canadian Coast Guard MCTS Centre by radiotelephone. Messages shall include:

- (a) time in Co-ordinated Universal Time (UTC) that pilot is required on board;
- (b) place vessel is to be boarded;
- (c) pilotage service to be performed;
- (d) whether or not vessel has been granted radio pratique;
- (e) name, nationality, length, breadth, draft and gross tons of ship.

183 **Tariff of pilotage rates** can be obtained from:

Pacific Pilotage Authority Canada
1000 – 1130 West Pender
Vancouver, B.C. V6E 4A4
Telephone (604) 666-6771
Fax (604) 666-1647
info@ppa.gc.ca
<http://www.ppa.gc.ca/>

184 **Pilot Ladder Regulations.** — Serious accidents associated with embarkation and disembarkation have resulted in death and maiming of Canadian Pilots. Regulations require the owner or Master of every ship to comply with these regulations.

185 Every ship shall be equipped with a ladder that is:

- efficient for the purpose of enabling pilots to embark and disembark safely;
- kept clean;
- maintained in good order and condition.

Every pilot ladder shall be secured so that:

- it is clear from any possible discharge from the ship;
- each step rests firmly against the ship's side;
- it is clear as far as practicable of the finer lines of the ship;
- the pilot can safely and conveniently gain access to the ship after climbing not less than 1.5 metres.

See *Notices to Mariners 1 to 46 Annual Edition* for more details.

186 **Pilotage in United States waters** is compulsory for all vessels except those under enrolment or engaged exclusively in the coasting trade on the west coast of the continental United States (including Alaska) and/or British Columbia. Port Angeles is the designated pilotage station for all vessels en route to or from sea. Pilotage for Puget Sound and adjacent inland waters is provided by the Puget Sound Pilots (<http://www.puget-sound-pilots.com/>).

187 Pilotage, except for certain exempted vessels, is compulsory for all vessels navigating the inside waters of Alaska and is provided by the Southeast Alaska Pilots' Association (<http://www.seapa.com/>) in Ketchikan. Pilot boarding stations or pickup points for approaching SE Alaska through Dixon Entrance are in Clarence Strait (*55°27'N, 131°53'W*) and Revillagigedo Channel (*55°08'N, 131°13'W*).

188 Information on pilotage in U.S. waters is in *United States Coast Pilots 7 and 8*.

Port Facilities and Services

189 **Principle ports** have facilities for large commercial vessels. For detailed services information consult the appropriate geographical book of Sailing Directions.

190 **Campbell River** is at the south end of Discovery Passage. A wharf for loading ore has depths of 10.3 m alongside. A pulp and paper mill in **Duncan Bay** has four berths with least depths alongside from 3.2 m to 9.6 m. Maximum tidal range for Campbell River is 4.8 m.

191 **Chemainus** is on the west side of Stuart Channel and has two deep-sea berths. It is usually approached from the Strait of Georgia via Porlier Pass and Houstoun Passage. This port exports forest products and imports petroleum products. Maximum tidal range for Chemainus is 4.3 m.

192 **Cowichan Bay** has two berths for exporting forest products. Depths alongside the berths are 8.3 m and 9.3 m. Chemainus Bay is usually approached from Haro Strait by way of Satellite Channel. Maximum tidal range for Cowichan Bay is 3.9 m.

193 **Crofton** is on the west side of Stuart Channel. It is usually approached from the Strait of Georgia, by way of Porlier Pass and Houstoun Passage. This port exports forest products, pulp and newsprint. It has three deep-sea berths with 12.0 m to 12.2 m depths alongside. Maximum tidal range for Crofton is 4.1 m.

194 **Esquimalt Harbour**, at the SE end of Vancouver Island, is approached from Juan de Fuca Strait; it is a public harbour. The harbour is a base for the Canadian Forces and for repairing large commercial vessels. There are two dry docks and other repair facilities in the harbour. Maximum tidal range for Esquimalt is 3.3 m.

195 **Fraser River Harbour** – known as **Fraser Port** – extends from the mouth of the south arm of Fraser River to well past the city of **New Westminster** but excludes the North and Middle Arms of the river. Water levels in the river are

Port	Position
Campbell River	50°02'N, 125°15'W
Chemainus	48°55'N, 123°43'W
Cowichan Bay	48°45'N, 123°36'W
Crofton	48°52'N, 123°38'W
Esquimalt Harbour	48°26'N, 123°26'W
Fraser River Harbour	49°12'N, 122°54'W
Kitimat	54°00'N, 128°40'W
Nanaimo Harbour	49°10'N, 123°56'W
North Fraser Harbour	49°12'N, 123°08'W
Port Alberni Harbour	49°14'N, 124°49'W
Port Alice	50°23'N, 127°27'W
Port Mellon	49°31'N, 123°29'W
Powell River	49°52'N, 124°33'W
Prince Rupert	54°19'N, 130°18'W
Ridley Island	54°13'N, 130°20'W
Squamish Harbour	49°40'N, 123°12'W
Stewart	55°56'N, 130°00'W
Vancouver	49°17'N, 123°06'W
Victoria Harbour	48°25'N, 123°23'W

subject to seasonal fluctuations. Several overhead cables and bridges cross the river.

196 Berths in Fraser River Harbour are mainly for forest products, general cargo, automobiles and bulk cargoes. Depths alongside the berths range from 4.6 to 11.6 m.

197 **Kitimat** is at the head of Douglas Channel. Port facilities are all privately owned and serve an aluminium smelting plant, and a lumber and pulp mill. Deep-sea berths are dredged to depths of 10.7 m and 12.8 m. Maximum tidal range in Kitimat is 6.6 m.

198 **Nanaimo Harbour** includes within its defined limits the waters of Departure Bay, False Narrows, Dodd Narrows and Northumberland Channel. Nanaimo Port Authority wharves have three berths with 10.1 m to 12.4 m depths alongside, generally used for loading forest products. Berths at **Harmac**, in Northumberland Channel, are privately owned and used for loading forest products and have depths of 10.0 m and 12.4 m alongside. Also in Northumberland Channel are the Nexen Chemicals wharf with a depth of 11 m alongside and the Duke Point Assembly wharf with a depth of 13.5 m alongside. Maximum tidal range for Nanaimo Harbour is 4.9 m.

199 **North Fraser Harbour** covers most of the North and Middle Arms of Fraser River. Traffic in the harbour consists mainly of tugs towing log booms, scows or barges. There are several bridges and overhead cables along the entire length of the harbour.

200 **Port Alberni Harbour** limits cover all waters of Alberni Inlet. There are three deep-sea berths with 11.4 m to 12.2 m depths alongside. Maximum tidal range for Port Alberni is 3.8 m.

201 **Port Alice** is on the east side of Neroutsos Inlet and is approached by way of Quatsino Sound, on the west coast of Vancouver Island. It is the site of a large pulp mill. The largest vessel to use the wharf (1983) had a length of 183 m and draught of 10.7 m. Depths off the wharf are constantly changing due to silt. Maximum tidal range for Port Alice is 4.2 m.

202 **Port Mellon** is on the west side of Thornbrough Channel, in Howe Sound. It is the site of a large pulp mill. The wharf is 152 m long with a least depth of 10.6 m alongside.

203 **Powell River**, on the north side of the Strait of Georgia, is the site of a large pulp and paper mill with two deep-sea berths. Depths alongside these berths are maintained by dredging and range from 5.8 m to 9.8 m. Maximum tidal range for Powell River is 5.4 m.

204 **Prince Rupert** is under the jurisdiction of the Prince Rupert Port Authority. Its limits include all the waters of Prince Rupert Harbour, Tuck Inlet, Morse Basin, Wainwright Basin, Porpoise Harbour and the facilities at Ridley Island and Port Edward. Prince Rupert is the terminal of the Canadian National Railway. The deep-sea berth in Port Edward has a

depth of 9.4 m alongside and the deep-sea berths in Prince Rupert have depths of 9.0 m to 13.7 m alongside. Maximum tidal range for Prince Rupert is 7.5 m.

205 **Ridley Island Terminals** can berth a ship of dimensions 150,000 dwt, 22 m draught, 325 m length and 50 m beam.

206 Prince Rupert Grain Limited grain terminal can berth ships of 10,000 to 65,000 dwt and up to 234 m long. The least depth alongside the berth is 13.1 m.

207 **Squamish Harbour** is at the head of Howe Sound. Its deep-sea berths include the facilities at Woodfibre and Squamish. **Woodfibre**, on the north side of the harbour, is the site of a large pulp mill. It has two wharves with depths of 9 m alongside and a third wharf with a depth of 4.6 m alongside. Squamish Terminals have two berths with depths of 12.2 m and 11.1 m alongside. The former chemical wharf at the entrance to Mamquam Blind Channel is disused and redevelopment is pending. Maximum tidal range for Squamish is 5.1 m.

208 **Stewart** is at the head of Portland Canal. Main industries are mining, logging and tourism. The deep-sea berth has a depth of 10.9 m alongside. Maximum tidal range at Stewart is 7.8 m.

209 **Vancouver Harbour** includes all the waters of Burrard Inlet and two terminals at Roberts Bank, in the Strait of Georgia. Maximum tidal range for Vancouver is 5 m.

210 Main berths in the west part of the harbour, between First Narrows and Second Narrows, consist of container terminals, grain elevators, bulk loading and forest products berths, dry docks and repair facilities. Least depth through First Narrows is 15 m and the bridge has a vertical clearance of 61 m.

211 Berths east of Second Narrows are generally for petroleum and forest products.

212 **Victoria Harbour** at the SE end of Vancouver Island is approached from Juan de Fuca Strait. It is a public harbour. Four deep-sea berths at Ogden Point, in the entrance of the harbour, are used during summer months to accommodate cruise liners. Depths alongside are 11.0 m to 14.4 m. There are many smaller wharves for coastal tankers, tugs, barges, fishing vessels, ferries and Coast Guard. Maximum tidal range for Victoria is 3.3 m.

213 **Fuel Availability.** — Major grades of bunker fuel and diesel fuel can be obtained at Esquimalt, Fraser Port (New Westminster), Nanaimo, Vancouver and Victoria. Bunkering at these ports is normally carried out from barges.

214 Prince Rupert usually has a good supply of diesel fuel and is the only port north of Vancouver with fuel in quantities required by deep-sea ships. Deep-sea ships should make arrangement in advance for bunkers.

215 Fuel can be delivered by barge to other ports in British Columbia; such shipments generally originate in Vancouver.

216 **Repairs.** — All types of hull and engine repairs can be undertaken in Vancouver and Esquimalt. Underwater repairs by divers only, together with above-water repairs, propulsion machinery and electronics repairs can be undertaken in Nanaimo, Port Alberni and Victoria. Minor repairs can be undertaken in Chemainus and Crofton.

217 **Dry docks** include Prince Rupert, Vancouver Harbour, and Esquimalt Harbour.

218 **Prince Rupert** is the only port in northern British Columbia with repair facilities for deep-sea vessels. These are limited to minor hull and machinery repairs. One boatyard has a marine slip for vessels up to 46 m long.

219 **Vancouver Harbour** has two floating dry docks capable of taking deep-sea vessels, and several smaller dry docks and marine railways. Dimensions of the major floating dry docks, all on the north side of the harbour, are:

Lifting capacity: 36 000 tonnes
Extreme length: 220 m
Length over keel blocks: 204 m
Breadth: 45.8 m
Depth over blocks: 10.65 m

Lifting capacity: 8 163 tonnes

Extreme length: 146.3 m

Length over pontoons: 128 m

Breadth: 25.6 m

Depth over blocks forward: 5 m

Depth over blocks aft: 4.5 m

220 **Esquimalt Harbour** has two dry docks, Esquimalt Graving Dock is for commercial vessels and a Canadian Forces dry dock is for naval vessels.

Esquimalt Graving Dock

Extreme length: 357.8 m

Breadth at entrance: 41.1 m

Depths over sill at MHWS: 12.2 m

Canadian Forces Dry Dock

Extreme length: 146.6 m

Breadth of bottom of dock: 19.8 m

Depth over sill at MHWS: 8.8 m

Depth over blocks at entrance: 7.8 m

Depth over blocks at head: 7.5 m

221 **Deratting** certificates and deratting exemption certificates, in accordance with international health regulations, are obtainable at Victoria and Vancouver and in an emergency at Prince Rupert.

Navigational Hazards

Seamounts

1 Clusters and chains of ancient volcanoes rising at least 1 000 m from the seafloor are found in the northern Pacific Ocean from the Gulf of Alaska to the Oregon Coast. The most prominent of these seamounts, Bowie and Cobb, have summits shallow enough to pose serious threat to deep draught vessels.

2 **Bowie Seamount** summit is located at $53^{\circ}18'N$, $135^{\circ}40'W$ or approximately 180 km (97 nm) west of Haida Gwaii. It rises from a depth of more than 3 000 m to approximately 24 m below the sea surface. Bowie Seamount lies between the Tanker Exclusion Zone and the Exclusive Economic Zone and is within 18 km of the shipping routes of trans-Pacific traffic bound for Dixon Entrance. Low pressure weather systems moving south from the Gulf of Alaska frequently pass into the Bowie Seamount area and the formation of high winds and seas, fog and precipitation can make navigation hazardous.

3 **Cobb Seamount** summit is located at $46^{\circ}46'N$, $130^{\circ}49'W$ or approximately 500 km (270 nm) SW of the entrance to Juan de Fuca Strait, or 500 km west of Grays Harbour, Washington. Summit depth is 23.8 m. Cobb Seamount lies close to the rhumb line course between Valdes, Alaska and ports in California.

 4 **Caution.** — Wave studies indicate shallow water effects can be experienced near seamounts at these depths. During heavy seas give these seamounts a wide berth.

5 **Seamounts of no hazard to navigation** are found throughout the Canadian Exclusive Economic Zone. Hodgkins Seamount ($53^{\circ}30'N$, $136^{\circ}04'W$) has a summit depth of 596 m and Davidson Seamount ($53^{\circ}40'N$, $136^{\circ}34'W$) has a summit depth of 1 146 m. Both are near Bowie Seamount. Union Seamount ($49^{\circ}32'N$, $132^{\circ}41'W$) has a summit depth of 160 m.

Hydrographic and Seismic Surveys

6 Hydrographic and seismic surveys are conducted in Canadian and American waters. Details of these surveys are normally broadcast as *Notice to Shipping* by MCTS Centres.



Photo: Canadian Coast Guard - Pacific Region

Survey vessels tow sensing devices and can be encountered without notice.

7 Seismic survey sensing devices may be streamed 2.5 to 3.5 miles astern and if there are multi-streamers, they may be 50 or 100 m apart. The sensing device is ballasted so that it remains submerged just below the surface or at streamer depths ranging between 10 and 20 m. An orange buoy is usually attached to the end of the cable to mark extent of streamers. A white light and a radar reflector are fitted to this buoy.

8 Vessel or vessels surveying will usually be making way through the water but sometimes may stop for extended periods.

9 During seismic surveys repeated shock waves may be generated, at intervals of 5 to 10 seconds, by mechanical or electrical energy sources or by compressed air. Dynamite is rarely employed for this purpose but if used charges up to 1 000 kg may be fired. If charges are being fired by radio or electrically triggered detonators, survey vessels may suspend radio and radar transmissions to avoid accidental firings. Vessels being called by signalling light should answer by the same means and not by radio.

 10 **Caution.** — Explosive charges are contained in cylinders, canisters, tubes and bags and may not be marked dangerous. Do not attempt to recover such items. If any are inadvertently taken aboard remove them immediately. See *Notices to Mariners 1 to 46 Annual Edition* Section F, Notice 37.

Firing Practice and Exercise Areas

11 **Military exercise areas** are located in offshore areas west of Vancouver Island and in Juan de Fuca Strait, the approach to Victoria Harbour, Haro Strait, Strait of Georgia, Saanich Inlet and Jervis Inlet. Anti-aircraft firing exercises, air-to-sea firing and anti-submarine exercises occur in areas designated WP, WCFA North and WCFA South.

12 In the SW approach to Juan de Fuca Strait there is a United States military exercise area designated W237. This area is used for surface firing, anti-aircraft firing, air to sea firing and anti-submarine exercises including high explosive projectiles.

13 When a firing practice and exercise area is scheduled for use, information will be promulgated by local Canadian Coast Guard *Notices to Shipping* and may also be advertised in local newspapers.

14 Warning signals, when given, usually consist of red flags by day and red fixed or red flashing lights at night. Absence of any such signal cannot be accepted as evidence that a practice area does not exist. Warning signals are shown from shortly before practice commences until it ceases. Ships

and aircraft carrying out night exercises may illuminate with bright red or orange flares.

 15 **Although Range Authorities are responsible for ensuring that there should be no risk of damage from falling shell-splinters, bullets, etc., to any vessel that may be in a practice area, it is advisable to stay clear of these areas when they are in use.**

16 For full information on military exercise areas see *Notices to Mariners 1 to 46 Annual Edition*.

17 **Submarines** operate in Victoria approaches and in Juan de Fuca Strait. Submarines may surface or remain submerged and may operate independently or with surface ships and/or aircraft. Details of submarine presence indicators and navigation lights used by submarines and their surface ships are in *Notices to Mariners 1 to 46 Annual Edition*.

18 **Ships in formation.** — Guidelines for single vessels approaching a formation of warships or merchant vessels in convoy, or aircraft carriers and other warships at sea, are described in *Notices to Mariners 1 to 46 Annual Edition*.

19 **Lights on Canadian warships.** — Canadian warships are exempt from carrying the second steaming light prescribed by *Collision Regulations*. Warships may exhibit additional lights or signals; these are described in *Notices to Mariners 1 to 46 Annual Edition*.

20 **Spoil ground areas and explosives.** — There are a number of spoil ground areas used for dumping explosives in offshore areas west and SW of Vancouver Island. Most are in depths less than 200 m and others are close to abyssal depths. These areas are charted and the central position for each area is:

- 48°26'N, 125°17'W
- 48°25'N, 125°29'W
- 48°10'N, 125°31'W
- 48°16'N, 126°20'W
- 48°15'N, 127°00'W
- 48°50'N, 126°50'W
- 48°21'N, 125°43'W
- 48°23'N, 125°39'W

21 Historical review indicates that mustard and phosphene chemical warfare agents in various containers, including munitions, was also dumped at the spoil ground centred on 48°15'N, 127°00'W. Uncorroborated anecdotal information suggests that some of the warfare agents may have been dumped short of this intended location. Avoid anchoring or conducting seabed operations in this vicinity. See Warfare Agent Disposal Project at <http://www.wadproject.forces.gc.ca>.

22 Anyone with information concerning dumping of explosive or chemical warfare agents is urged to contact Department of National Defence (DND). Anecdotal information plays an important role in corroborating data and closing the information gaps that currently exist.

23 Unexploded bombs, in depths of more than 115 m, are at:

- *48°21'07"N, 125°19'28"W*
- *48°19'24"N, 125°41'12"W*
- *48°21'19"N, 125°19'37"W*
- *48°16'06"N, 126°06'13"W*
- *48°44'05"N, 126°47'17"W*

Fishing Vessels

24 **Fishing vessels** of several types operate in waters around Vancouver Island. The heaviest concentrations of fishing vessels occur during the herring fishery in March and the salmon fishery in:

- (a) Juan de Fuca Strait from July 1 to November 1;
- (b) Strait of Georgia and the Fraser River and its approaches from approximately July 1 to November 1 and sporadically throughout the year; and
- (c) Johnstone Strait from mid-June to the end of October.

25 In the approach to Juan de Fuca Strait, inside the 100 m line off Estevan Point, La Pérouse and Swiftsure Banks, numerous fishing vessels can be encountered between April 15 and September 30. These vessels may be trolling, trawling or, particularly at night, they may be at anchor. Due to the prevalence of fog and low visibility in this vicinity, mariners approaching from any direction are advised to pass to the south and clear of the banks.

 26 **Mariners who choose to cross these banks should navigate with extreme caution to avoid risk of collision with fishing vessels.**

27 Masters of vessels to seaward of Juan de Fuca Strait and within Canadian waters are required to maintain a continuous listening watch on VHF radiotelephone. Mariners can communicate with MCTS Tofino Traffic to exchange information or assist in making a safe passage through fishing areas.

28 VTS systems for the coastal waters of British Columbia designate VHF channels for specific sectors. Commercial vessels transiting open fishing grounds in the Inside Passage and Hecate Strait are advised to monitor Channel 78A (156.925 MHz) in addition to the VTS channel for the sector they are in. Vessels in transit through the grounds should broadcast their intended track at frequent intervals (every ½ hour) on VHF Channel 78A and more frequently under reduced visibility conditions.

29 **Commercial fishing methods** commonly used in British Columbia waters are purse seining, gillnetting, longlining, trolling and trawling.

30 **Purse seine nets** wall off, surround and then gather large numbers of fish. Nets are about 390 m long and 20 m

deep and are generally carried on a drum at the stern of a vessel. When a school of fish is located the seine net is set over the stern, often with one end secured to a skiff. The skiff goes a short distance from the vessel until a few fathoms of net have entered the water. The seiner then runs in a large circle around the school, returning to the skiff where the two ends of the net are joined. When in position the seine net stands like a fence in the water supported at the surface by floats and held down by a lead line or weights at the bottom. The “purse line” is strung through large metal rings along the bottom and when it is hauled in by a winch the bottom is drawn together forming a huge purse around the fish.

31 Purse seine nets are generally used for harvesting migratory species such as salmon and herring. Vessels usually operate near shore and are almost immobile when nets are cast. Purse seining vessels range from 12 to 33 m long and have a crew of four to eight. In salmon seining a dip-net or “brailer” scoops fish from the net. Herring is generally brought aboard by means of a hydraulic pump.

32 **Gillnets** hang like curtains from the surface of the water. Floats are attached to the upper edge of the net and leads along the bottom. Fish are caught when they swim into the net and become entangled in the webbing by their gills. Gillnets are about 360 m long and 10 m deep. When the net is set the vessel and net can drift for one to four hours. Gillnets are used extensively for harvesting salmon and herring.

33 Gillnet vessels usually operate in shallower water along sides of channels. When large concentrations of vessels are present they fish in deep centre-channel waters. Vessels range from 9 to 11 m in length and are usually operated by one person.

34 **Longlining** uses a main fishing line with a series of shorter lines along its length onto which baited hooks are fixed. Anchors secure the gear to the ocean floor. Both ends of the longline are marked by buoys.

35 A complete unit of longline gear is called a skate and, depending on the type of fishery, up to 12 000 hooks may be used in one skate 450 to 550 m long. Gear is dispensed over the stern through a metal trough or chute and is recovered over the bow of the vessel. Longlining is used for harvesting halibut, black cod and dogfish.

36 **Trolling** is where several fishing lines with numerous attached lures are dragged slowly through the water. Trollers can be recognized by two main poles set amidships, each about the length of the vessel. Some vessels have two additional shorter poles in the bow. Poles are upright when travelling and at a 45° angle when fishing. Rigging of boats and type and arrangement of lines and lures vary according to the fishery. Usually six stainless steel fishing lines are employed. Each line, which is up to 190 m long with a lead weight at its end, is attached to the poles by pulleys. These lines are reeled in

and out on separate gurdy spools with individually controlled clutch and brake mechanisms.

37 Trolling vessels are usually 10 to 15 m long and carry a crew of two to four. When engaged in fishing these vessels are always moving, usually in straight lines. In British Columbia, trolling is used to harvest salmon, halibut and albacore.

38 **Trawlers** use the otter trawl method, where a long, wedge-shaped net narrows into a funnel-shaped bag called the cod-end. The mouth of the net is kept open during trawling by two otter doors that are made of iron-clad wood or metal. As the trawl is towed along the ocean floor fish entering the net are forced into the cod-end. The net can be towed for up to three hours.

39 Pacific coast trawlers, also known as “draggers”, range from 12 to 33 m in length and have a crew of two to eight. Groundfish such as lingcod, ocean perch, sole and flounder are the main harvest.

 40 **Passing distance.** — **Do not pass close to vessels engaged in fishing. Seiners and trawlers should be given a clearance of at least 1 km, and gillnetters and trollers 0.5 km. If unable to avoid running over a fishnet, stop engines immediately and maintain a course straight across the net rather than turning.**

41 **Special visual signals.** — Under *Collision Regulations Part D – Sound and Light Signals, Annex II Additional Signals For Fishing Vessels In Close Proximity – International*:

2. Signals for trawlers

- (a) Vessels of 20 m or more in length when engaged in trawling, whether using demersal or pelagic gear, shall exhibit:
 - (i) when shooting their nets: two white lights in a vertical line;
 - (ii) when hauling their nets: one white light over one red light in a vertical line;
 - (iii) when the net has come fast upon an obstruction: two red lights in a vertical line.
- (b) Each vessel of 20 m or more in length engaged in pair trawling shall exhibit:
 - (i) by night, a searchlight directed forward and in the direction of the other vessel of the pair;
 - (ii) when shooting or hauling their nets or when their nets have come fast upon an obstruction, the lights prescribed in paragraph 2(a) above.
- (c) A vessel of less than 20 m in length engaged in trawling, whether using demersal or pelagic gear or engaged in pair trawling, may exhibit the lights prescribed in paragraph (a) or (b), as appropriate.

3. Signals for purse seiners

Vessels engaged in fishing with purse seine gear may exhibit two yellow lights in a vertical line. These lights

shall flash alternately every second and with equal light and occultation duration. These lights may be exhibited only when the vessel is hampered by its fishing gear.

4. Special visual signals

In Canadian waters and fishing zones, a vessel engaged in pair-trawling shall exhibit at the foremast the International Code flag “T” during the daylight hours.

42 **Special sound signals.** — Under *Collision Regulations, Part D – Sound And Light Signals, Rule 35 Sound Signals in Restricted Visibility – International*: (c) A vessel not under command, a vessel restricted in her ability to manoeuvre, a vessel constrained by her draught, a sailing vessel, a vessel engaged in fishing and a vessel engaged in towing or pushing another vessel shall instead of the signals prescribed in paragraph (a) or (b) of this Rule, sound at intervals of not more than two minutes three blasts in succession, namely one prolonged followed by two short blasts.

43 Under *Annex II Additional Signals For Fishing Vessels In Close Proximity – International*:

5. Special sound signals

- (c) In Canadian waters and fishing zones, a vessel engaged in fishing as described in Rule 26(f) shall, in any condition of visibility, sound the following signals on her whistle:
 - (i) four blasts in succession, namely, two prolonged blasts followed by two short blasts when shooting a net or gear;
 - (ii) three blasts in succession, namely, two prolonged blasts followed by one short blast when hauling a net or gear;
 - (iii) four blasts in succession, namely, one short blast followed by two prolonged blasts, followed by one short blast when a net or gear is fast to an obstruction.
- (b) When in or near an area of restricted visibility, the signals described in paragraph (a) shall be sounded four to six seconds after the sound signal prescribed in Rule 35(c).

44 **Marking of fishing gear.** — Fishing gear set in all Pacific coast waters under Canadian jurisdiction are marked as follows:

- (d) A gillnet operated from a commercial fishing vessel has attached to each end of it,
 - (i) by day, a buoy painted iridescent or plain orange and not less than 125 cm in circumference;
 - (ii) by night, a lantern showing a white light;
- (b) A longline used in fishing is marked by a buoy attached to each end of the line;
- (c) A crab, shrimp or prawn trap set singly marked by a buoy.

45 Fishermen at various locations along the British Columbia coast sometimes use quick flashing lights on their

COMMERCIAL FISHING METHODS

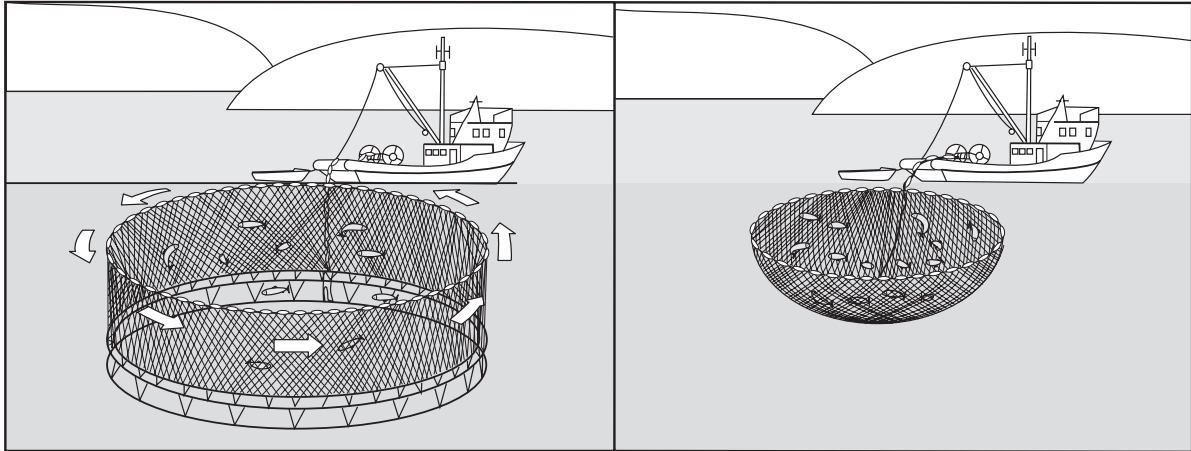

PURSE SEINING

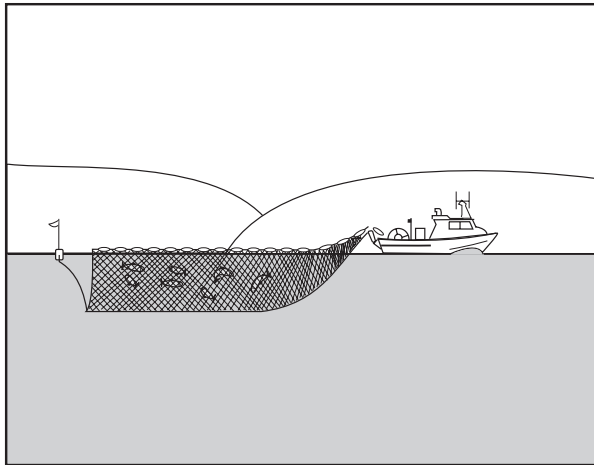

GILLNETTING

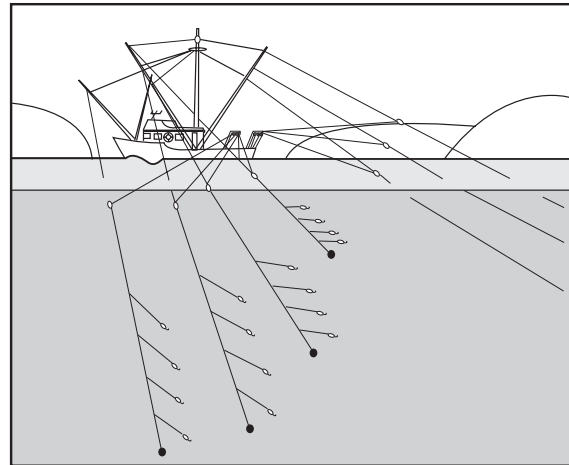

TROLLING

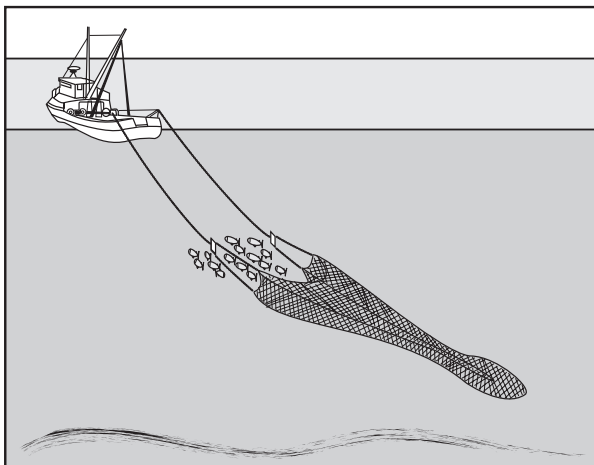

OTTER TRAWLING

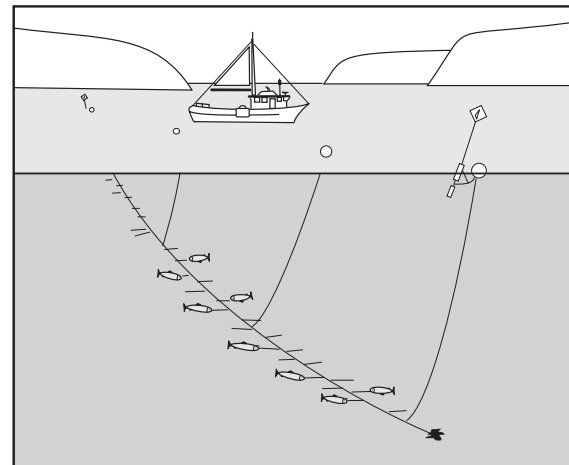

LONGLINING

net floats. Care must be taken not to confuse these lights with lighted aids to navigation.

46 **Fishing boundary markers** with white, orange or yellow triangles (outline only) can be seen in many locations along the shores of coastal waters. These markers indicate fishing zone boundaries and are not aids to navigation.

Aquaculture

47 **Aquaculture** is the raising of animals and plants in salt or fresh water. Marine farming is a relatively new and rapidly expanding industry along the British Columbia coastline. Some facilities are charted or advertised in *Notices to Mariners* and *Notices to Shipping*. Due to rapid industry expansion positions are not accurately known for all facilities. Maintain a safe distance to avoid creating damage from excessive wash and to avoid collisions and entanglement.

48 Rearing salmon and growing oysters are the main commercial enterprises along the coast at present. Small experimental industries are involved in raising abalone, scallops, mussels, sablefish, kelp and herring roe on kelp.

49 **Fish farms** in British Columbia produce coho and chinook salmon. Atlantic salmon is also raised. A typical salmon farm consists of floating walkways from which net pens are hung in the water 6 m or more deep. A large work and storage area is usually on the adjacent shore. Some farms are exclusively water-based and have large barges containing work, storage and living areas. Others are moored close offshore along major shipping channels such as Alberni Inlet or are moored in bays and inlets used by commercial and recreational vessels for anchorages. In some of the shallower, less frequented bays and inlets farms may be moored in the centre of the fairway.

50 **Oyster farms** are established in many locations along the coast. Two methods are used for growing oysters: bottom culture and off-bottom culture.

51 **Bottom culture** is the most common method and is confined to intertidal zone areas protected from excessive wave action. Oysters are frequently grown on the bottom where the foreshore is fine gravel or sand. Where the bottom is mud they are suspended from individual stakes driven into the bottom. Sometimes racks are used. Mariners should avoid creating excessive wash near these facilities and should not attempt to land.

52 **Off-bottom culture** methods use floating platforms from which the oysters are suspended. The floating platforms can be a raft, log float or a series of buoys linked by ropes. These floating facilities are left in one position for about two years and are then moved to the intertidal zone where the oysters are harvested.

53 Most oyster farms grow oysters from spat collected in Pendrell Sound or Pipestem Inlet. In mid- to late July oyster seed collectors gather oyster spat from these locations. Hatcheries for growing oyster broodstock are slowly replacing this method of obtaining oyster spat.

54 Other aquaculture facilities, such as **herring roe on kelp**, are used seasonally. The facilities are moored offshore in sheltered inlets and during the off-season are moored alongside the shore.

 55 **Caution.** — **Frequent aquaculture site changes require mariners to proceed with caution. Areas previously occupied by fish farms may be encumbered with submerged debris that can be a danger to navigation. Avoid anchoring in such areas.**

Traffic

56 **Seaplanes.** — In recent years the number of marine traffic incidents between vessels and seaplanes has increased. At a particular stage of taking off or landing seaplanes are committed and unable to change their intended action at the last minute. Adverse weather is generally more restrictive to seaplanes on the water than to ships. In addition, passing close to or ahead of a seaplane whose engines are operating creates an obvious hazard.

57 Mariners should avoid areas where seaplanes are known to operate, particularly in conditions of poor visibility. Adherence to practices of good seamanship should reduce the number of incidents between vessels and seaplanes.

58 **Ferry routes** shown on charts are general indications of the route followed by ferries. Ferries can be encountered anywhere within the vicinity of a route shown.

 59 **Large ferries are limited in their ability to manoeuvre particularly at low speed and during docking. Small craft should avoid passing close to ferries at all times.**

60 **Freighter traffic.** — An awareness of where shipping traffic is most likely to be encountered goes a long way toward making navigation easier and safer.

61 British Columbia waters are used by cargo vessels of various types and sizes and by ferries, tugs, barges and log booms. Operators of pleasure craft are reminded that *Collision Regulations, Rule 9(b)* states: “A vessel of less than 20 metres in length or a sailing vessel shall not impede the passage of a vessel which can safely navigate only within a narrow channel or fairway”.

62 In narrow channels such as Vancouver’s First Narrows, or in many narrow passages in the Gulf Islands such as Active Pass and Porlier Pass, the combination of narrow channels, shallow waters, winds, currents and tidal stream effects make navigating large vessels difficult. Planning of

TYPICAL AQUACULTURE SITE LAYOUTS

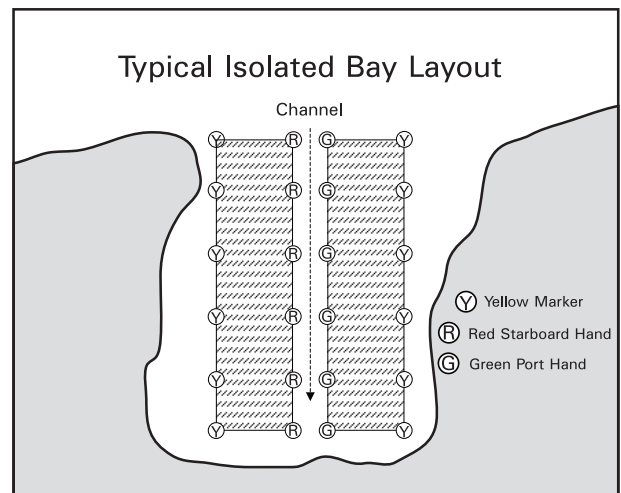
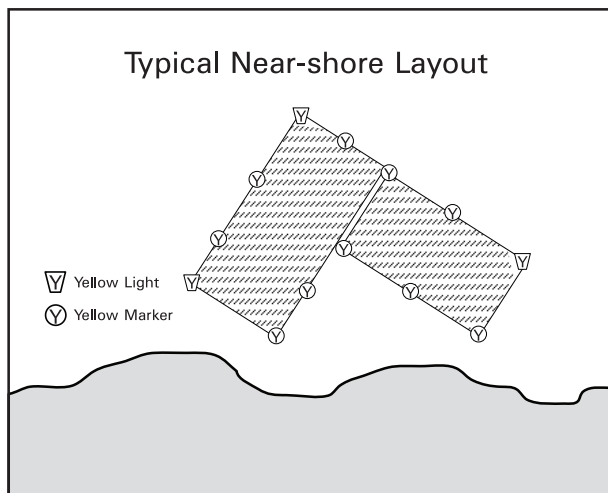
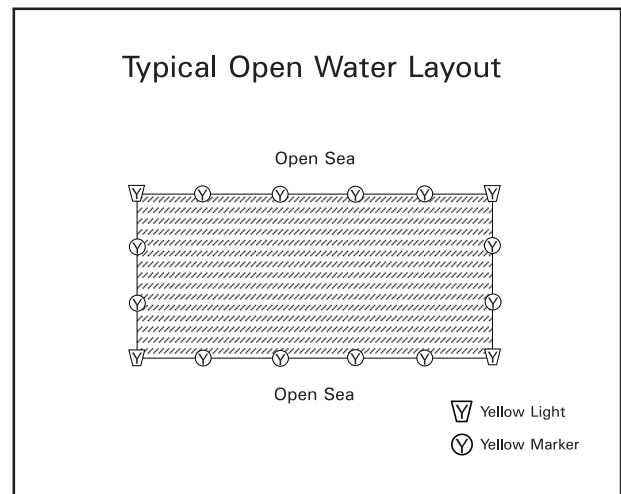
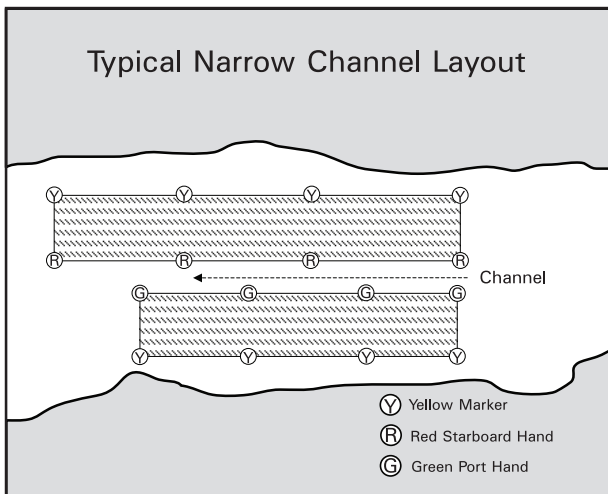
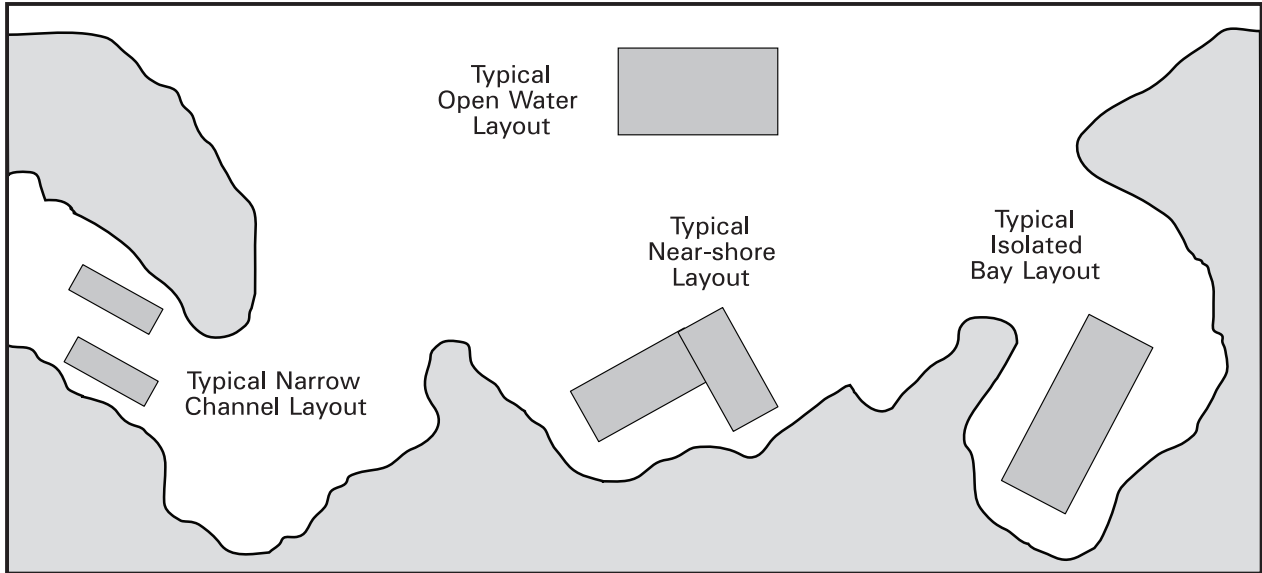



manoeuvres and following pre-set courses is usually necessary for large vessels to navigate narrow passages safely. Deviation from pre-set courses presents potential for running aground or interfering with sailing routes of other commercial vessels.

63 In addition to interfering with commercial vessels many operators of small craft endanger themselves by going too close to these large vessels. Operators of small craft should also remember that the view from the bridge of a large vessel can be obscured up to 61 m ahead of the vessel and as much as 15 m on either side.

64 **Barges under tow.** — Pick-up lines are trailed astern of barges under tow. A pick-up line can be up to 110 m long, and the end marked by a fluorescent buoy. All vessels should pass astern of towed barges at a sufficient distance to clear such trailing lines.

65 **Logbooms.** — Due to extensive logging along the British Columbia coast, tugs towing logbooms or rafts are frequently encountered, often in confined waterways. Booms are usually at the end of a long scope of towline that can be run foul of in conditions of poor visibility unless due care is exercised.

 66 **Caution.** — Never pass between a towboat and its tow. The towline, though not visible, may be just below the surface and will cause serious damage or fatalities when struck.

 67 **Driftwood.** — **Drifting logs are a pervasive danger. Small vessels are advised to exercise extreme caution at all times, especially when running at night.**

68 All sizes of logs are encountered individually but more often they are grouped together in various sizes. They are usually located near tidal swirls and eddies. Entire trees complete with branches and foliage may be encountered, usually during early summer when rivers are in their freshest stage and debris is washed towards the ocean.

69 Storms and extreme tides cause large numbers of drifting logs to wash off beaches. During calm weather floating logs can be found lying in any direction in a channel and if there is any sea they usually lie in the trough of waves.

70 **A particular danger is the “deadhead”** or log saturated with water. The resulting loss of buoyancy causes the log to become almost entirely submerged, usually in a vertical position with its visible end awash or just below the sea surface. Deadheads are invisible during daylight hours unless a slight sea or swell causes them to break the surface.

71 Notification of dangers to navigation, such as drifting logs or deadheads, are often broadcast as *Notices to Shipping* from MCTS Centres. Mariners are requested to notify the nearest MCTS Centre of any such hazard to navigation. Such messages may also be sent as Safety Signals to other mariners in the area.

Cables and Pipelines

 72 **Caution.** — **Canadian charts and information promulgated in *Notices to Mariners* do not differentiate between power and other types of cables. All overhead and submarine cables must be treated with caution.**

73 **Submarine cables and pipelines** are found throughout British Columbia waters. Many were installed before accurate electronic position-fixing systems were available so charted positions may not be accurate. A generous allowance should be made when selecting an anchorage in the vicinity of a cable.

74 Mariners should avoid anchoring or trawling in cable areas. Serious interference with telecommunications or power supplies will result from damage to cables.

75 If an anchor or fishing gear foul a cable and bring it to the surface a capsized situation may develop due to the extra load. In this situation every effort should be made to clear the anchor/fishing gear by normal methods. Should these efforts fail the anchor/gear must be slipped and abandoned.

76 **Do not attempt to cut a submarine cable.** High voltages are fed into cables and risk of death or severe burns due to electrocution exist if any attempt to cut a cable is made. A cut cable may also result in loss of services such as the ability to make emergency telephone calls. This may have serious and in some cases fatal consequences.

77 **Submarine pipelines** are generally found near harbours or across rivers and channels and are charted where information is available. They are installed on the seabed and where conditions permit may be buried. Every care should be taken to avoid anchoring or trawling near pipelines.

78 Any vessel fouling a pipeline should slip or abandon the anchor or gear without attempting to clear it. Any excessive force applied to a pipeline could result in a rupture. In the case of a gas pipeline the resultant release of gas at high pressure would be followed by an immediate fire hazard or explosion.

79 **Overhead cables** cross many major channels, harbours, inlets and rivers. Most cables are charted but existing ones are frequently modified or removed. These changes, together with new cable installations, are promulgated in *Notices to Mariners* when information is available.

80 An overhead cable may conduct high voltages and contact with, or close proximity to, such cables poses extreme danger. If the clearance cannot be obtained from local authorities, then allow 5 m less than the vertical clearance. Actual clearance will differ from charted clearance due to changes in atmospheric and water level conditions.

81 Elevation (clearance) of overhead cables is given above Higher High Water, Large Tide (HHWLT) in tidal waters. In non-tidal waters elevation is given above Chart

Datum. In non-tidal waters the height of water level above Chart Datum must be subtracted from the charted elevation to give actual elevation at a particular time.

 82 **Caution.** — **There can be a time delay between installation of submarine cables, pipelines, overhead cables and their subsequent publication in *Notices to Mariners*. Pay attention to submarine cable or pipeline signs onshore and look for overhead cables across any waterway. Installation may occur without proper notification in which case it is possible that *Notices to Mariners* are not issued and dangers are not charted.**

83 Radar echoes from overhead power cables appear on the scan as a single echo always at right angles to the line of the cable. Therefore, it can be incorrectly identified as the radar echo of a vessel on a steady bearing or collision course. If avoiding action is attempted the echo remains on a constant bearing moving to the same side of the channel as the vessel altering course.

84 **Magnetic compass and power cables.** — Submarine or overhead power cables carrying direct current can cause deflection of the magnetic compass needle in vessels passing over or under them. The amount of deflection depends on the amount of electric current and the angle the direction of the cable makes with the magnetic meridian.

85 Paired cables laid within 1.5 m of each other and in which the current is running in opposite directions can cause deflections of up to 2° if the compass is within 20 m of the cable.

86 Single cables carrying currents of 1 000 amperes can cause needle deflections of more than 2° when the compass is within 150 m and can increase to 90° or more in shallow water when the distance is within 10 m. Small vessels with an auto-pilot reliant upon a magnetic sensor may experience a large course alteration when crossing such a cable in shallow water.

Bridges

87 In tidal waters the vertical clearance of bridges is given above Higher High Water, Large Tide (HHWLT). In non-tidal waters, vertical clearance is given above Chart Datum. Horizontal clearances are sometimes shown on charts or given in the appropriate geographic booklet of *Sailing Directions* if particularly restrictive.

88 Bridges often have a large number of lights on them for both navigation and illumination purposes. It is not always possible to chart all lights on any particular bridge.

89 Bridges over navigable waters may be built and not immediately charted due to lack of information. Caution should be used particularly in built-up areas.

90 Some bridges swing or lift to provide clearance necessary for safe navigation. In some cases operation times are limited. The advance notice required to open a bridge may also be significant. This is necessary to minimize disruption to rail and road traffic, particularly where emergency services such as police, fire and ambulance are concerned. More information can be found in the appropriate geographic booklet of *Sailing Directions*. Information regarding operations for some, but not all of these bridges, may also be found in *Radio Aids to Marine Navigation (Pacific and Western Arctic)*.

Magnetic Anomalies

 91 Direction of the magnetic compass needle at some places will differ appreciably from the normal direction for the area. Magnetic anomalies are probably due to masses of magnetic iron ore or ore rock strata containing iron in the seabed under the vessel. When water is shallow and the force strong, the compass needle may be temporarily deflected when passing over such a spot but the area of disturbance will be small unless there are many centres close together.

92 **Local magnetic anomalies** have been reported in:

- Haro Strait off Bellevue Point
- Welcome Passage
- Strait of Georgia off Spilsbury Point
- Comox Harbour
- Retreat Passage at east end of Queen Charlotte Strait
- 75 miles SW of Cape Scott off the west coast of Vancouver Island
- along the north side of Dixon Entrance off Cape Muzon
- off Percy Islands near the south end of Clarence Strait
- the south entrance to Revillagigedo Channel SE of Duke Island (differences are as much as 50° and magnetic compass should not be relied on)
- Nakat Inlet

Local magnetic anomalies have also been reported in:

- Paddy Passage
- Harriet Harbour
- Barnard Harbour
- Laredo Channel
- Meyers Passage
- Milbanke Sound
- Merilia Passage
- Cousins Inlet

93 Whenever a ship passes over an area of local magnetic disturbance the position should be fixed and facts reported as far as they can be ascertained.

94 **Magnetic storms** vary in intensity and frequency with the sunspot cycle, similarly to aurorae. An intense magnetic storm is always accompanied by a bright and active aurora. The deeply coloured aurora showing more pronounced red and green and sometimes blue and violet tints are invariably connected with magnetic storms of considerable or great intensity.

95 Some magnetic storms are associated with the state of a local area of the sun. As the same part of the sun is again presented to the earth after an interval of about twenty-seven days such storms and the associated aurora may recur at this time interval. Other magnetic storms, usually including the most intense ones, occur at random times; these are usually associated with eruptive flares of the sun and occur about one or two days following the flare. The frequency of occurrence and intensity of magnetic storms follows an 11-year cycle, with maxima being observed near the years of sunspot maximum (1979/80, 1990/91, 2001/02 and so on).

96 A ship's compass may deviate during the progress of a magnetic storm. These deviations are usually about $\frac{1}{2}^\circ$ to 1° . They can occur to either side of the mean and can last from 10 to 60 minutes.

97 At Victoria, B.C. fluctuations up to $1\frac{1}{2}^\circ$ to either side of the mean have been recorded during major magnetic storms. The magnitude of these fluctuations increases to the north, reaching a maximum in the vicinity of the auroral zone, about 60° – 70° N on the B.C. coast, where deviations up to 3° can be expected during major magnetic storms. Such intense events are rare (1–3 times per year) and the more usual range is $\frac{1}{2}^\circ$ to 1° . Nevertheless, when bright aurora is seen particularly if it is of the more deeply coloured and rapidly moving kind, or if it is observed at lower latitudes, the possibility of deflection of the compass should be noted.

98 During a considerable magnetic storm freak radio reception can occur on certain wave lengths and short wave transmission can fade to complete silence. Beam radio communications, especially in a west/east or east/west direction, may be interrupted. Such conditions may last over several days at times when the sun is unusually active. Short wave fading also occurs occasionally from a different form of solar disturbance known as a "bright eruption". On average, such fading begins about seven minutes after the occurrence of the bright eruption and can last 5 to 10 minutes, gradually returning to normal within 40 to 50 minutes. These fadings are confined to the daylight hemisphere of the earth while magnetic storm fadings can occur at any time.

Natural Environment and Protected Areas

99 Aquatic plants and animals require special consideration in the marine natural environment and protected areas.

Kelp will be seen on the surface, growing on nearly every danger with a bottom of rocks or stones, especially in channels where water is in constant motion. Kelp is often absent in harbours and inlets where there is little movement of water.

100 Kelp is more abundant in summer and autumn months. During winter and spring this useful marine plant is not always seen.

101 Along the open coast kelp is often attached to the bottom at depths up to 15 m. In Haida Gwaii where plants can be well over 30 m in length they usually occur at depths up to 20 m. In the Strait of Georgia most floating kelp will be

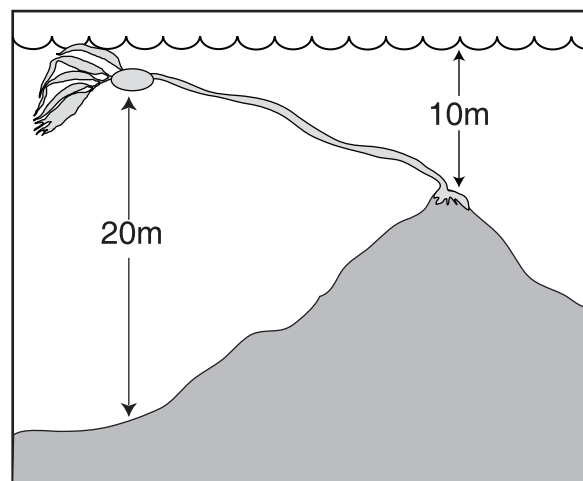

Kelp

found in depths less than 10 m. Kelp can be attached to the sea floor up to the lowest level to which tide normally falls. Presence of kelp can indicate water depths from 0–20 m.

102 **Never pass over kelp.** In general, by keeping clear of kelp danger is avoided but this must not reduce attention to soundings as the rule sometimes fails. Kelp is always a sign of danger, and unless the spot where it grows has been carefully sounded, it is not safe for a vessel to pass through it.

103 A heavy surge will occasionally tear kelp away from rocks and a stream of moderate velocity will ride it underwater, where it will not be seen. When passing on the side of a kelp patch, from which stems stream away with the current, care should be taken to give it a wide berth. Kelp showing with a strong tide is on one side of and not over the rocks. Least water will usually be found at a clear spot in the middle of a thick patch of fixed kelp.

104 Kelp not attached to rock will float on the water in heaps, whereas kelp attached to rocks streams away level with the surface and leaves will undulate if the current is strong.

105 **Sponge reefs** are found in four separate locations over 700 km² of seafloor in Queen Charlotte Sound and Hecate Strait. Lying in depths between 165 and 240 m, these

reefs consist of very dense populations of living hexactinellid (glass) sponges. Often more than 1 m in height they create mounds up to 19 m high and often many kilometres wide.

106 Long thought to have disappeared with the dinosaurs, but discovered by Canadian scientists in 1991, these are the world's first known sponge reefs. These unique reefs are under threat from trawl fishing in which heavy nets are dragged along the sea floor. Efforts are being made to seek protected status for these areas.

107 **Whale watching guidelines.** — Whales may be encountered throughout the waters off British Columbia. The following guidelines should be followed to avoid disturbing or injuring these animals:

1. Be cautious and courteous. Approach areas of known or suspected marine mammal activity with extreme caution. Look in all directions before planning your approach or departure;
2. Slow down. Reduce speed to less than 7 knots when within 400 metres/yards of the nearest whale. Avoid abrupt course changes;
3. Avoid approaching closer than 100 metres/yards to any whale;
4. If your vessel is unexpectedly within 100 metres/yards of a whale, STOP IMMEDIATELY and allow the whales to pass;
5. Avoid approaching whales from the front or from behind. Always approach and depart whales from the side, moving in a direction parallel to the direction of the whales;
6. Keep clear of the whales' path. Avoid positioning your vessel within the 400 metre/yard area in the path of the whales;
7. Stay on the offshore side of the whales when they are traveling close to shore. Remain at least 200 metres/yards offshore at all times;
8. Limit your viewing time to a recommended maximum of 30 minutes. This will minimize the cumulative impact of many vessels and give consideration to other viewers;
9. Do not swim with or feed whales.

107.1 **Southern Resident Killer Whale Critical Habitat Areas and Interim Sanctuary Zones.** — **Southern Resident Killer Whales** are an endangered species and are protected under the *Species at Risk Act*. Stressors on the whales include limited availability of Chinook salmon, physical and acoustical disturbances, oil spills, and contaminants. The areas and zones protecting the whales are in the waters off southwestern Vancouver Island and the transboundary areas of southern British Columbia and northern Washington. A lateral displacement area is within the outbound shipping lane in Juan de Fuca Strait. A voluntary speed limit of 7 knots is recommended and a minimum distance of 400 metres/yards

(0.215 nautical miles) should be kept from the whales or any other marine mammal. For more information see *Notices to Mariners Annual Edition 1 to 46* Section A2, Notice 5.

107.2 **Northern Resident Killer Whale Critical Habitat Areas and Interim Sanctuary Zones.** — **Northern Resident Killer Whales** are an endangered species and are protected under the *Species at Risk Act*. Stressors on the whales include limited availability of Chinook salmon, physical and acoustical disturbances, oil spills, and contaminants. The areas and zones affecting marine traffic are the continental shelf waters off southwestern Vancouver Island including Swiftsure Bank and La Pérouse Bank, southeastern Queen Charlotte Strait, and the waters of Dixon Entrance along the north coast of Graham Island from Langara to Rose Spit. A voluntary speed limit of 7 knots is recommended and a minimum distance of 400 metres/yards (0.215 nautical miles) should be kept from the whales or any other marine mammal. For more information see *Notices to Mariners Annual Edition 1 to 46* Section A2, Notice 5.

108 **Migratory Bird Sanctuaries.** — Environment Canada has established Marine Bird Sanctuaries (MBSs) (*Migratory Birds Convention Act*) to protect coastal and marine habitats used by birds for breeding, feeding, migration and over-wintering. Scientific research occurs regularly in these areas.

109 There are several MBSs on the British Columbia south coast. On Vancouver Island sites include Shoal Harbour, Esquimalt Lagoon and Victoria Harbour and on the lower mainland sites include Christie Islet and the George C. Reifel Migratory Bird Sanctuaries.

110 Migratory Bird Sanctuary regulations prohibit disturbance of migratory birds, their eggs, and their nests. Mariners should remain at a distance to avoid disturbing wildlife both by engine noise and from wash.

111 The regulations also prohibit disturbance of migratory bird habitat when MBSs are established on federal Crown land. In most MBSs, visitors must not carry firearms or allow their pets to run at large. In northern Canada, Aboriginal people have the right to carry firearms in MBSs for traditional hunting and trapping purposes.

112 For more information on Migratory Bird Sanctuaries refer to the Canadian Wildlife Service web site at <http://www.cws-scf.ec.gc.ca/habitat/default.asp?lang=en&n=45457D0B>.

113 In addition to MBSs there are five Important Bird Areas (IBAs) recognized in the southern Strait of Georgia. Chain Islets, Sidney Channel, Active Pass, Porlier Pass and Snake Island IBAs are identified sites for seabird breeding, feeding and wintering. For more information see the IBA Canada web site at www.ibacanada.ca.

114 **Marine Protected Areas.** — Fisheries and Oceans Canada has designated Marine Protected Areas (MPAs)

(*Oceans Act*) for the conservation and protection of all fishery resources, endangered or threatened species, and their habitats. The mandate also designates these areas for scientific and research purposes.

115 Six planning regions for Marine Protected Areas have been identified: North Coast, Haida Gwaii, Central Coast, West Coast of Vancouver Island, Strait of Georgia, and Offshore.

115.1 **MPA Prohibited Activities.** — With some exceptions no person shall:

- (a) Disturb, damage or destroy, or remove from the Area, any living marine organism or any part of its habitat;
- (b) Disturb, damage or destroy or remove from the Area, any part of the seabed; or
- (c) Carry out any activity — including depositing, discharging or dumping any substance, or causing any substance to be deposited, discharged or dumped — that is likely to result in the disturbance, damage, destruction or removal of a living marine organism or any part of its habitat.

116 For more information on Marine Protected Areas refer to Fisheries and Oceans web site at http://www.pac.dfo-mpo.gc.ca/oceans/mpa/default_e.htm.

117 **Ecological Reserves.** — Under the jurisdiction of the Province of British Columbia (Ministry of Environment) Ecological Reserves (*Ecological Reserves Act*) have been established to protect representative examples of the marine environment and the rare, endangered or sensitive species or habitats which exist within them. Ecological reserves contain unique features of interest to scientific researchers. They are not created for outdoor recreation and should not be confused with parks or other recreational areas. They are open to the public for non-consumptive, observational uses only. For more information refer to the Ministry of Environment Ecological Reserves web site at http://www.env.gov.bc.ca/bcparks/eco_reserve/ecoresrv/ecoresrv.html.

118 **Indian Reserves** are found in many places on the British Columbia coast and should not be landed without permission. It is an offence to deface or remove Indian artefacts.

Search and Rescue

119 Canadian Forces, supported by the Canadian Coast Guard, are responsible for co-ordinating all **Search and Rescue** (SAR) activities in Canada, including Canadian waters and high seas off the coasts of Canada. SAR operations in the Pacific area are co-ordinated at the Joint Rescue Co-ordination Centre (JRCC) at Canadian Forces Base Esquimalt. Canadian Forces and Coast Guard officers maintain a continuous watch

at this centre. The JRCC is the headquarters of a network of agencies trained to search for and aid vessels in distress. It is alerted by Coast Guard MCTS Centres or SAR units immediately upon receiving a distress signal.

120 All Government of Canada ships and aircraft are available for SAR duties when required, as are all Canadian registered ships in accordance with the *Canada Shipping Act*. Canadian Coast Guard operates a number of specialized vessels whose prime mission is SAR. They are easily identified by red hulls and white superstructures.

121 The *Canada Shipping Act* allows the Master of any vessel in distress to requisition any vessel or vessels to come to his assistance. Even if he has done so and the situation appears well in hand it is advisable for the Master to ensure that the JRCC concerned is informed and kept up to date since the JRCC has at its disposal expertise and resources specialized in SAR.

122 A vessel requisitioned to assist a vessel in distress is required to comply with direction from the JRCC and/or the Master of the vessel in distress. The *Canada Shipping Act* sanctions penalties for refusal to give aid. The JRCC may delegate its authority to the Master of a vessel on the scene, who is then termed the “Co-ordinator Surface Search (CSS)” or “On-Scene Commander (OSC)”.

123 **Patrol vessels.** — Canadian Coast Guard vessels specialized in SAR conduct regular patrols in all areas of commercial and recreational fishing, commercial and recreational transit, and in other areas where marine activities occur.

124 **SAR craft are stationed at:**

- Bamfield
- Campbell River
- French Creek
- Ganges
- Old Bella Bella
- Port Hardy
- Powell River
- Prince Rupert
- Sandspit
- Tofino
- Vancouver
- Vancouver (Sea Island; hovercraft)

125 During summer months – between mid May and early September – Coast Guard supplements rescue vessels with rubber boats trailered to any launching area in case of emergency.

126 **Royal Canadian Marine Search and Rescue (RCM-SAR)** is a volunteer organization co-ordinated by the Coast Guard. It is comprised of individuals with marine experience who supplement regular facilities by providing SAR services in local areas. These volunteers have been formed into groups at various strategic locations along the coast. As with all Search and Rescue operations, the volunteers will

be dispatched and co-ordinated through the Joint Rescue Co-ordination Centre, Esquimalt. Vessels fly a distinctive pennant when involved in SAR activities. Marinas and other locations that host a unit will fly a RCM-SAR pennant to indicate help is available at that location. Further information on this organization can be obtained from the Canadian Coast Guard or the JRCC in Esquimalt. See also the Canadian Coast Guard web site at <http://www.ccg-pacific.org/ccga-p/>.

127 **Air resources.** — Canadian Forces maintain fixed wing aircraft and helicopters dedicated and equipped for SAR at CFB Comox, on Vancouver Island. Other aircraft are available from federal and provincial departments if required. JRCC Victoria will also charter local helicopters to perform certain SAR functions.

128 **Airborne liferaft.** — Canadian Forces fixed wing aircraft and helicopters are capable of dropping inflatable liferafts and survival equipment. The complete drop consists of a line 305 m long with a 10-person dinghy at each end and a number of survival packages in between. This is dropped upwind of a distressed mariner; the dinghies inflate upon contact with the water. Helicopters are equipped with a rescue hoist and can deploy rescue specialist personnel and metal stretchers for evacuation.

129 **Helicopter evacuation** can be hazardous to both patient and helicopter crew and should only be used as a last resort to prevent death or permanent injury. If you are fishing, for example, and one of the crew suffers a slight injury, do not request a helicopter medical evacuation so that you can continue fishing.

130 If helicopter evacuation is necessary you must be prepared to proceed within range of a helicopter. Most rescue helicopters can proceed less than 150 miles offshore and then only if weather conditions permit. New Cormorant helicopters can proceed up to 200 miles offshore, conditions permitting. If you are beyond helicopter range advise the Coast Guard of your intentions so a rendezvous point can be selected.

131 In order for Coast Guard to evaluate the need for helicopter evacuation the following information should be ready:

- (a) Name of vessel, call sign, position, course and speed;
- (b) Patient's name, age and sex;
- (c) State of consciousness;
- (d) Respiration rate and difficulty or pain associated with breathing;
- (e) Pulse rate, strength and regularity; temperature of patient;
- (f) Nature and specific location of pain. Is pain dull, sharp, continuous, intermittent, confined to a small area or widespread;

- (g) When injury occurred and cause – blow, burn, fall – nature of wound, cuts or bruises. State if patient has been moved;
- (h) Determine amount of bleeding;
- (i) Describe any deformity or abnormal functioning on the part of the patient;
- (j) What treatment has been given and how patient has responded;
- (k) ETA destination/intentions;
- (l) Agent's or owner's name, address;
- (m) Frequency vessel standing by on and other back-up frequencies available;
- (n) If helo is to be involved: position on the ship best suited for helo hoist – clear of obstructions – and frequency for helo to contact vessel on.

132 **When helicopter evacuation of personnel is planned** prepare a suitable hoisting area, preferably aft, with a maximum radius of clear deck, 16 m if possible. The foredeck should be prepared only when the stern and amidships area cannot possibly be used. If bow area is the only area available, speed should be close to 5 kn and change course to place the wind 15° – 30° off the starboard quarter. Be sure to advise the helicopter before it arrives so the pilot can approach to aft, amidships or forward, as required. Point search lights vertically to aid helicopter in locating the ship; turn them off when helicopter is on the scene.

133 In preparing hoist area booms, flag staff, stays, running gear, antenna wires, etc., must be cleared away. Secure loose gear, headgear worn by crew in the hoist area, and awnings, and trice up running gear. At night, light the pick-up area but shade lights so as not to blind the pilot. Put lights on any obstructions in the vicinity so the pilot will be aware of their position. Arrange a set of hand signals to be used among crew members who will assist because there will be a high noise level under the helicopter and voice communications on deck will be virtually impossible.

134 **Do not secure any line from a helicopter to the vessel.** Tend it by keeping a moderate tension on it by hand. Allow the SAR technician, basket or stretcher from the helicopter to touch the deck before assisting to avoid static electrical shock.

135 Leave the patient in a warm, dry area. The SAR technician lowered to the vessel will evaluate the patient's condition and organize hoisting of the patient to the helicopter. Make sure documentation is available, such as passport, visa, hospital insurance card, etc., as well as the patient's medical record and have them packaged and ready for transfer with patient. Have a life-jacket available but do not put it on the patient until the SAR technician has made an examination.

136 **Sail Plan.** — Small craft operators are encouraged to prepare a Sail Plan before starting on a trip and leave it ashore with a responsible person or any Coast Guard MCTS Centre.

A checking-in procedure, by telephone or radiotelephone, for each point specified in the Sail Plan is highly recommended as this could prevent a needless alert that might set off a comprehensive air and marine search. A Sail Plan is provided at the back of this book. Additional copies are available from any Coast Guard office.

137 **AMVER.** — Automated Mutual-Assistance Vessel Rescue System, sponsored by the United States Coast Guard, is a unique, computer-based, and voluntary global ship reporting system used worldwide by Search and Rescue authorities to arrange for assistance to persons in distress at sea. With AMVER, rescue coordinators can identify participating ships in the area of distress and divert the best-suited ship or ships to respond. AMVER's mission is to quickly provide Search and Rescue authorities, on demand, accurate information on the positions and characteristics of vessels near a reported distress.

138 Merchant vessels of all nations making offshore passages of more than 24 hours are encouraged to send sail plans and periodic position reports to the AMVER Centre.

139 On the west coast of Canada, merchant vessels reporting to AMVER can address their message "AMVER VICTORIA" through any MCTS Centre free of charge. For further details see *Radio Aids to Marine Navigation (Pacific and Western Arctic)*.

140 **Distress message.** — If in distress (threatened by serious and imminent danger) and immediate assistance is required transmit the International Distress Call **MAYDAY** three times on 2182 kHz and/or VHF Channel 16 (156.8 MHz). If transmission on these frequencies is impossible, any other frequency on which attention might be attracted should be used. Any MCTS Centre, or vessel, that hears a distress message will reply and initiate Search and Rescue action.

141 **Urgency message.** — The transmission of a distress message could start an extensive sea and air search that might continue for several days in hazardous weather. If you are in urgent need of assistance but not in distress, transmit the Urgency Signal **PAN PAN** three times on 2182 kHz and/or VHF Channel 16 (156.8 MHz). Further details concerning distress and urgency communications are given in *Radio Aids to Marine Navigation (Pacific and Western Arctic)*.

142 **Ship-to-air distress signal** for use in Canadian waters has been designed in conjunction with Search and Rescue authorities. The signal consists of a cloth painted or impregnated with fluorescent paint showing a disc and square to represent the ball and flag of the international visual distress signal. Evaluation tests by Search and Rescue aircraft indicate the most suitable colour combination is black symbols on a background of fluorescent orange-red. The smallest useful size is a cloth 1.8 m by 1.1 m showing symbols that have dimensions of 46 cm and are the same distance apart. Grommets or loops should be fitted at each corner to take securing lines.

143 Since the purpose of the signal is to attract the attention of aircraft it should be secured across a hatch or cabin top. In the event of foundering, it should be displayed by survival craft. Search and Rescue aircraft recognize this signal as a distress signal and look for it in the course of a search. Any aircraft, on seeing this signal, is requested to make a sighting report to the JRCC.

144 The signal is commercially available but can be made at home or aboard ship without difficulty. A length of unbleached calico or similar material and a can of fluorescent orange-red spray paint are the main requirements. This signal is optional but it is hoped that Masters of vessels will use it for increasing the effectiveness of Search and Rescue operations.

145 **Aircraft signals.** — The following manoeuvres by an aircraft means it wants to direct a surface craft toward an aircraft or surface craft in distress:

- Aircraft circles surface craft at least once;
- Aircraft crosses projected course of surface craft close ahead at low altitude and rocks its wings, or opens and closes throttle, or changes propeller pitch. Due to possible high noise levels onboard surface craft, rocking of wings is the usual way of attracting attention. Engine and propeller signals may be less effective and are alternative methods;
- Aircraft heads in direction in which surface craft is to be directed. A repetition of such manoeuvres has the same meaning.

146 The following manoeuvre by an aircraft means the assistance of the surface craft to which the signal is directed is no longer required:

- Aircraft crosses wake of surface craft close astern at a low altitude and rocks its wings, or opens and closes throttle, or changes propeller pitch.

147 **COSPAS-SARSAT System.** — COSPAS: Space System for Search of Distress Vessels (Russian acronym); SARSAT: Search and Rescue Satellite-Aided Tracking. COSPAS-SARSAT is an international satellite surveillance system designed to detect and locate distress signals from emergency beacons onboard boats, aircraft and from hand-held personal locator beacons. The system is a network of satellites, ground stations, mission control centres and rescue coordination centres based worldwide.

148 COSPAS-SARSAT satellites detect emergency beacon distress signals from Earth, transmit the location to a ground station (in Canada – Edmonton, Alberta; Churchill, Manitoba; and Goose Bay, Labrador) and the information is then forwarded to a COSPAS-SARSAT control centre (in Canada – Canadian Forces Base Trenton). The control centre alerts the Search and Rescue centre nearest the incident and SAR teams then take over.

149 **EPIRB** (Emergency Position-Indicating Radio Beacon) is a small floating and portable beacon. When acti-

vated it transmits a distress signal. There are two classes of beacons, the free release Class 1 EPIRB with automated activation, and the manually activated Class 2 EPIRB. The most common beacons are those which transmit on the 406 MHz frequency and which use COSPAS/SARSAT satellites, and Inmarsat EPIRBs which transmit on 1.6 GHz. The signal sent by these beacons enable the localisation of the EPIRB and the identification of the owner. **It is essential to register the beacon in the National Beacon Database (1-800-727-9414).**

150 **SART** (Search and Rescue Transponder) is a portable radar transponder for use in lifeboats and life rafts. When it receives marine radar waves, the SART sends a signal which appears as a series of dots on a radar display. This allows a vessel to detect and locate those in need of rescue.

151 **Radar reflectors** on small vessels increase the probability of detection by SAR ships and aircraft. Reflectors also aid in collision avoidance.

152 A small craft that is the object of a search should place a radar reflector high as possible on the craft. If a radar reflector is not carried, large metallic objects might be of some use. All Coast Guard patrol vessels, aircraft, and some buoy tenders use radar and thus can continue searches in darkness and periods of low visibility if it can be assumed that the object of the search can be detected by radar.

153 Observations have shown that wooden hulls or other non-metallic objects may show on radar, depending on their

size, orientation, shape, and radar reflecting qualities. They make better radar targets if there are special radar-reflecting devices properly oriented and placed as high above the waterline as possible. The largest metallic object available should be used. Collapsible radar reflectors are available from most ship chandlers.

154 *Rule 40 of Collision Regulations* requires small vessels less than 20 m in length or vessels constructed primarily of non-metallic materials to fit or carry a radar reflector.

155 For further information concerning Search and Rescue consult *Notices to Mariners 1 to 46 Annual Edition* and *Radio Aids to Marine Navigation (Pacific and Western Arctic)*.

156 For general information on Search and Rescue in Canada see the National Search and Rescue Secretariat web site at http://www.nss.gc.ca/site/index_e.asp.

157 **In United States waters** the United States Coast Guard conducts and/or co-ordinates Search and Rescue operations for surface vessels or aircraft that are in distress or overdue. Search and Rescue vessels and aircraft have special markings, including a wide slash of red-orange and a small slash of blue on the forward portion of the hull or fuselage. Other parts of aircraft, normally painted white, may have other areas painted red to facilitate observation. For further details see *United States Coast Pilots 7* and *8*.

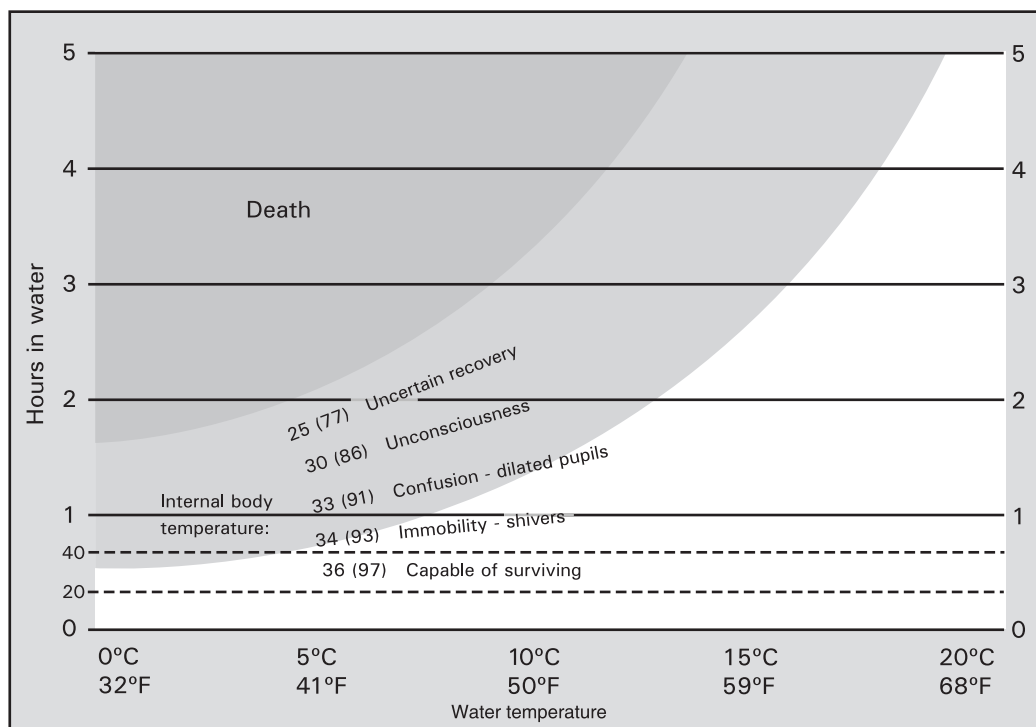

Life Expectancy in Water

Stages of immersion in which death may occur (water temperature 15°C or less, no flotation, no thermal protection):

Stage	Event	Elapsed time	Cause of death
1	Cold shock	3-5 minutes after immersion	Drowning, cardiovascular and respiratory problems
2	Swimming failure	30 minutes after immersion	Impaired physical performance resulting in inability to self-help; swimming failure and drowning
3	Hypothermia	30 minutes of immersion	Deep body cooling leading to hypothermia and drowning
4	Post-rescue collapse	Point of rescue or up to several hours afterward	Collapse of arterial blood pressure leading to cardiac arrest

Cold Water Survival

158 Year-round cold water temperatures and variable sea states along the B.C. coast affect cold water survival. Physical fitness, type of clothing, morale, injury or body temperature at the time of immersion influence the victim's survival time. Rescue is not a guarantee that an immersion victim will survive.

159 Death from drowning will occur in a lightly dressed individual wearing a PFD or a life jacket approximately two hours after immersion in water at 5°C, or in three hours in water at 10°C, or in six hours or less at 15°C. Without thermal protection – i.e. an immersion suit – chances of survival after long exposure to cold water are slim.

160 To increase chances of survival in cold water wear gear that fits, clean and maintain safety gear, and use gear that will increase chances of being rescued. Safety gear must have flotation, be easily detected by rescuers, and provide protection, mobility, and warmth.

161 In almost all weather conditions the body cools much faster in water than in air, so the less body surface submerged the better. If possible, pull up onto wreckage or a rock. Parts of the body with rapid heat loss are the head, neck, chest, and groin. To reduce body heat loss, protect these areas.

162 **Hypothermia** is dangerously low body temperature. Immersion in water cooler than core body temperature (37°C) for even a short period of time can seriously compromise the body's ability to function. Quick rescue and correct management of the hypothermic person are essential survival. Note that mild and severe hypothermia differ in symptoms and in treatment.

SURVIVAL IN COLD WATER



(1) Huddle together as closely as possible.

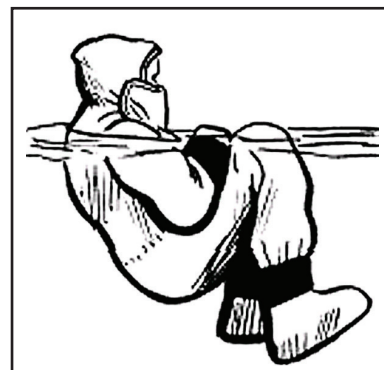

(2) Attempt to keep neck and head out of water. A PFD must be worn to maintain this position.



(3) Avoid staying in the water if possible.

163 **Symptoms of mild (non life-threatening) hypothermia** are:

- feeling cold or even numb;

- shivering, possibly quite violently, but able to stop shivering voluntarily;
- able to speak normally and answer questions appropriately;
- fine motor skills such as using hand tools or operating a radio may be slightly impaired; large motor skills such as walking are unaffected.

164 **Treatment of mild hypothermia.** — Remove immersion victim from the cold, remove wet clothing and providing warm blankets or clothing. Warm, sweet drinks or a hot meal will provide fuel to help the body warm itself. Watch for any changes in level of consciousness, which may indicate a dropping core temperature.

165 Even if the victim has been exposed to cold water for only a short time severe (life-threatening) hypothermia can result.

166 **Symptoms of severe (life-threatening) hypothermia** are:

- violent shivering which cannot be stopped voluntarily;
- slurred speech, confusion, inappropriate responses to questions, sleepiness;
- staggering, clumsiness, appearance of drunkenness;
- any other sign of reduced level of consciousness;
- unconsciousness;
- total unresponsiveness;
- rigidity;
- absence of breathing and absence of pulse;
- bluish or white skin, cold to the touch;
- may appear dead.

167 **Treatment of severe hypothermia.** — Treat the immersion victim gently. Rough handling may cause further stress on the heart causing it to beat erratically or it may stop beating completely. If unconscious, assess airway and breath-

ing. If breathing is not detected, begin rescue breathing using mouth to mask method (with oxygen if available by qualified personnel). Check carotid pulse (found on either side of the neck). Severe hypothermia will make pulse detection very difficult so great care must be taken to determine whether a pulse is present. Administering chest compressions over a weakly beating heart may cause erratic heartbeat (ventricular fibrillation) or full cardiac arrest. Rescuers should take at least two minutes to look for a pulse before starting chest compressions.

168 If the immersion victim cannot be immediately moved to shelter, wrap in space blankets or tarps to slow down heat loss due to evaporation. Once moved to shelter, remove all wet clothing, wrap in warm blankets and apply chemical heat packs to high heat-loss areas such as the groin, armpits, chest, head and neck. If an Inhalation Warming Unit (Res-Q-Air) is available, a trained rescuer should apply it. If the victim is revived and is fully conscious, warm sweet drinks without caffeine or alcohol may be given. Do not put victim into a hot bath or shower, and do not rub the extremities in an attempt to warm them up. Transport to a medical care facility as soon as possible.

169 Signs of life in a severely hypothermic person are difficult to detect. Even if the immersion victim appears dead, basic life support must be started and maintained. One to two hours of resuscitation effort is recommended. Exposure to cold can help preserve the body and increase chances of recovery.

170 For more information see the Canadian Coast Guard *SAR Seamanship Reference Manual* at http://www.ccg-gcc.gc.ca/sar/nsm-msn/main_e.htm and Transport Canada *Survival in Cold Waters* report at <http://www.tc.gc.ca/marinesafety/Tp/Tp13822/menu.htm>.

Aids to Navigation, Radio and Electronic Positioning

Aids to Navigation



1 **Aids to Navigation** on CHS charts are shown according to ownership. Those labelled (Priv) or *Priv* are owned and maintained by private organizations or individuals. Generally, information on these Aids to Navigation may not be as up to date compared with those owned by government or government agencies. Information on private aids is harder to find and maintain through *Notices to Shipping* and *Notices to Mariners*.

2 Private aids may not fully comply with standards, may not be well maintained, and are often subject to more frequent change. **These aids should be used with caution.**

3 **Lights.** — *Pacific Coast List of Lights, Buoys and Fog Signals* and *The Canadian Aids to Navigation System* must be consulted for full details concerning characteristics of lights, light buoys and fog signals.

4 **Emergency lights**, activated by failure of a main light, are installed at some light stations. They have a normal visibility of five miles and characteristic is Group Flash (6) 15 seconds.

5 **Light sectors.** — *Pacific Coast List of Lights, Buoys and Fog Signals* and *charts* do not always indicate any limitations to the arc of visibility of a light. Lights may be obscured on some bearings that are not shown. Rapid growth of trees on the west coast of Canada makes it possible for a light erected in a cleared area some years ago to become obscured by new growth.

6 **Fog signals.** — Sound is conveyed in a capricious way through the atmosphere. Apart from wind, large areas of silence have been found in different directions and at different distances from fog signals. In some instances even when close to a signal, sound can be lost.

7  **Mariners are strongly cautioned that they must not judge distance from a fog signal by the power of sound. It is also important never to assume that a fog signal is not in operation just because it cannot be heard, even when close to the station.**

8 **Air obstruction lights** are usually red or white in colour. They are shown either singly or in groups on high objects dangerous to air navigation such as hills, radio masts and tall chimneys. These lights are charted in locations where they may be of use to the mariner.

9 **Daybeacons.** — Although many fixed Aids to Navigation support and display a light for night navigation, some do not. Unlit aids, known as daybeacons, are used where night navigation is negligible or where it is not practical to operate a light.

10 Colour and shape are characteristics that identify the significance of a daybeacon. The lateral system for fixed aids is based on the same upstream direction used for buoys. Reflective material is applied to daymarks to improve their identification at night with the aid of a searchlight.

11 **Range marks.** — Unless otherwise stated, daymarks for ranges described in the geographic books of *Sailing Directions* are the shape as shown for typical range daymarks in the coloured diagram for normal navigation buoys.

12 **Buoys.** — The International Association of Lighthouse Authorities (IALA) Maritime Buoyage System Region B applies in Canadian and United States waters. The Canadian system includes lateral, cardinal and special buoys. Shape and/or colour of the buoy and colour and flash characteristic of the light indicate function of the buoy. *Chart No. 1 Symbols, Abbreviations and Terms* explains buoy symbols used on Canadian charts.

13 In cases where it is necessary to establish a buoy near an existing aid to navigation or navigation hazard, the buoy symbol may be offset slightly on a chart so that the existing symbol or hazard is not overprinted.

 14 **Buoy Caution.** — **Mariners should not rely on buoys to be in their charted positions at all times. Buoys should be regarded as aids to navigation and not as infallible navigation marks. The position of any buoy may not be as charted due to storm, collision, current, or undersea features such as shoals, reefs, or ledges that tend to render the buoy easily displaced.**

15 **Lateral buoys** indicate the course of a navigable waterway. Sides of the navigable waterway are indicated by buoys of a defined shape, colour or light characteristic in relation to the upstream direction.

16 There are six types of lateral buoys:

- port hand
- starboard hand
- port bifurcation
- starboard bifurcation
- fairway
- isolated danger.

17 **Upstream direction** is the direction from seaward, toward the headwaters, into a harbour, up a river or with the flood tide. In general, the upstream direction is in a northerly direction along the Pacific coast, in an easterly direction along the Arctic coast and in a southerly direction along the Atlantic coast. Although the flood tides meet in vicinity of Sentry Shoal ($49^{\circ}55'N$, $125^{\circ}00'W$), this has no effect on buoyage, which

should be treated as though flood tidal streams continue north beyond this point.

 18 **It is critical to establish upstream direction in order to use lateral buoys safely. Failure to do so may result in passing a lateral aid to navigation on the wrong side. Always consult the chart to ensure a correct understanding of the position of aids to navigation in relation to the dangers they are marking.**

19 **Buoy numbering.** — Only starboard and port hand navigation buoys are numbered. Starboard hand buoys have even numbers and port hand buoys have odd numbers. Buoy numbers increase in the upstream direction and are kept in sequence on both sides of a channel by omitting numbers where required. Buoy numbers are usually preceded by one or two letters to facilitate identification.

20 **Cardinal buoys** indicate the relative position of a hazard on the compass scale with buoys of defined shape, colour or light characteristic. Cardinal buoys have yellow and black horizontal bands and have topmarks consisting of two black cones. When lighted, lights are white.

21 There are four cardinal buoys, one for each cardinal point on the compass. When using cardinal buoys, keep to the named side of the buoy i.e. to the north of a North Cardinal Buoy. **Always consult the chart for details of the danger.**

22 **Special purpose buoys** in Canadian waters do not have lateral or cardinal significance. They can be a variety of shapes of lighted and unlighted buoys and may display yellow reflecting material. Except for ODAS (Ocean Data Acquisition System) buoys, special purpose buoys may have a yellow flashing light; an ODAS buoy may have a group flashing yellow light.

23 The term Ocean Data Acquisition System (ODAS) describes a wide range of devices used to collect meteorological and oceanographic data. They include ships, buoys, plastic envelopes and drift bottles.

24 In the north-eastern Pacific Ocean, Environment Canada operates a total of 17 year-round moored buoys consisting of 13 coastal three metre discus buoys, one experimental three metre discus buoy, and three offshore six metre NOMAD (Navy Oceanographic and Meteorological Automatic Device) buoys. These buoys report data to ground stations through GOES (Geostationary Operational Environmental Satellites) and Argos-tracking satellites.

25 The North Pacific Array of drifting buoys collect meteorological data beyond the coverage of the moored buoy network. These buoys report through Argos-tracking satellites and often give advance warning of rapid pressure drops indicating storm development and intensification.

26 The Marine Environmental Data Service (MEDS), a branch of Fisheries and Oceans Canada, acquires, processes, quality controls and archives real-time drifting buoy messages

Moored ODAS Buoys	Location
Patricia Bay	48.65°N, 123.50°W
La Perouse Bank	48.84°N, 126.00°W
Halibut Bank	49.34°N, 123.73°W
South Brooks	49.74°N, 127.93°W
Sentry Shoal	49.91°N, 124.99°W
East Dellwood	50.87°N, 129.92°W
West Sea Otter	51.37°N, 128.75°W
South Moresby	51.83°N, 131.22°W
South Hecate Strait	52.42°N, 129.79°W
West Moresby	52.52°N, 132.69°W
North Hecate Strait	53.62°N, 131.10°W
Nanakwa Shoal	53.83°N, 128.83°W
West Dixon Entrance	54.16°N, 134.28°W
Central Dixon Entrance	54.38°N, 132.45°W
North Nomad	53.91°N, 138.85°W
Middle Nomad	50.93°N, 136.10°W
South Nomad	48.35°N, 133.94°W

Source: Environment Canada. Positions effective 11/06. This table will not be maintained. Refer to Notices to Shipping for updates.

reporting over the Global Telecommunications System (GTS) as well as delayed mode data acquired from other sources.

27 **Bell and whistle buoys.** — Buoys of all types can be fitted with a bell or whistle that is activated by the motion of the buoy in water. Since the sound produced by these devices has no regularity and cannot be controlled, no lateral significance can be related. Sounds act only as a warning during periods of low visibility.

28 **For buoys in United States waters** consult *United States Coast Guard Light List, Volume VI*.

29 **Malfunctioning aids to navigation should be reported immediately to the nearest MCTS Centre so information can be broadcast as a Notice to Shipping.**

30 **Landmarks and conspicuous objects.** — A landmark is a natural feature or an artificial structure on land which is prominent from seaward and which the mariner can use to determine a direction or position. The term excludes structures built expressly for navigational purposes such as daymarks or daybeacons.

31 In remote areas landmarks are usually extraordinary natural features such as landslides, odd-coloured rock formations, coastal waterfalls or other features which are distinguishable from the surrounding topography. In urbanized areas, landmarks most often charted are man-made structures such as towers, church spires, domes, chimneys, flagpoles, and buildings.

32 Although the term landmark and conspicuous object are usually considered to be synonymous, in strict sense conspicuous objects are those which are plainly visible over large areas of the sea in varying conditions of light. Illustrative landmarks include symbols depicting artificial features and natural prominent features for the purpose of determining range or bearing by visual means (or radar) in coastal waters to determine a fix or estimated position. Charted landmarks are the logical equivalent of shore-based aids to navigation for use in coastal waters.

33 **Radio** provides mariners with one of the chief aids to navigation when navigating the west coast of Canada. To ensure maximum advantage it is essential to consult the latest edition of *Radio Aids to Marine Navigation (Pacific and Western Arctic)*.

Radio Aids to Navigation

Channel	Purpose
05A	VTS Seattle
06	Intership safety International SAR on-scene
09	Emergency communications for General Radio Service radios (CB)
11	VTS Victoria Sector 1 VTS Prince Rupert North Sector 1 Pilotage
12	VTS Victoria Sector 3 Ports Operations Pilotage
13	Bridge to bridge navigational traffic
14	VTS Seattle Ports Operations Pilotage
16	International distress, safety and calling
21B	Weather & NOTSHIP
83A	Ship and Canadian Coast Guard working frequency (Victoria and Comox)
26	Ship-to-shore for emergencies
66A	Marinas
68	Inter-ship and ship-to-shore for recreational vessels
70	Calling and alerting DSC
71	VTS Prince Rupert Sector 2
74	VTS Prince Rupert South Sector 1 VTS Victoria Sector 2
78A	Inter-ship for fishing vessels
83A	Ship and Canadian Coast Guard working frequency (Victoria)
84	Ship-to-shore for emergencies
WX1	Weather & NOTSHIP
WX2	Weather & NOTSHIP
WX3	Weather & NOTSHIP

34 **Coverage and factors affecting communications.** — Canadian Coast Guard provides reliable two-way radiotelephone communications with all ships within range of stations on the coast. The 2 MHz band is the backbone of the radiotelephone system. Additional facilities in the 4 MHz band have been installed at a number of stations to provide coverage over greater distances. Radiotelephone service is also provided at VHF (Very High Frequency).

35 **Limiting conditions 2 MHz band.** — Under ideal conditions limits of coverage are set by quality of system installation, the power of the ship's transmitter, the sensitivity of its receiver, and the efficiency of its antenna system. Unfortunately ideal conditions are not always present. Under adverse conditions it is difficult and at times impossible to maintain good communications between ship and shore stations. The main factors detrimental to good communications are:

- (a) Interference from radio signals which "skip" from great distances at night due to changes in the ionosphere (sky-wave propagation);
- (b) Fading signals, caused by night-time sky-wave propagation interfering with direct path (ground-wave propagation transmissions);
- (c) Sunspot cycle;
- (d) Static crashes due to thunderstorm activity;
- (e) Land masses intervening between ship and coast stations and causing a reduction in signal strength, as is the case when a ship is in a fjord or long inlet surrounded by mountains such those found on the coast of British Columbia.

36 There is also a reduction in signal strength when a ship approaches the coast and the proportion of land area to sea area between the ship and the shore station gradually increases.

37 Beside the advantage of the single sideband (SSB) technique as a means of conserving spectrum space, it is possible to overcome to some extent the atmospheric effects detrimental to good communications at night by employing SSB on both ship and shore stations. At such times this transmission technique offers an advantage of about 200% in range over double sideband (DSB) transmission.

38 A coastal ship having a transmitter with a power of 100 watts feeding into as efficient an antenna as shipboard limitations will allow can expect coverage of approximately 200 miles on the 2 MHz band. Many ships in coastal service are fitted with transmitters with power much less than 100 watts and therefore coverage for such ships can be expected for a distance of about 100 miles. These rough estimates assume the use of double sideband emissions under normal conditions. Adverse conditions may substantially reduce this coverage.

39 **Very High Frequencies (VHF)** from 156 to 174 MHz are assigned to the Maritime Mobile Service on a world wide basis. Not only does the use of VHF relieve the congestion on 2 and 4 MHz bands, but since VHF frequencies are free of the effects of atmospheric disturbances they can be used to great advantage. Most coast stations are equipped with facilities that make it possible to duplicate on VHF the marine telephone and message services offered on the 2 and 4 MHz frequencies. By using VHF, coverage is obtainable to more than the line-of-sight distance between coast and ship station antennas; a "radio horizon" with an average distance of about 50 miles can be obtained. In adverse conditions VHF offers a distinct advantage over 2 and 4 MHz within its limits of coverage.

40 **Ship to ship radio.** — To ensure safe navigation in Canadian waters and fishing zones the practices and procedures to be followed by persons onboard ships in respect of bridge-to-bridge VHF radiotelephones are prescribed in the *Recommended Code of Nautical Procedures and Practices*.

41 The Canadian Coast Guard maintains a system of communications between shore **Marine Communications and Traffic Services (MCTS) Centres** and vessels navigating in Canadian coastal and inland waterways. MCTS Centres in British Columbia having ship-shore communications facilities are:

- **Prince Rupert** call sign *VAJ*
Sector 1 North Channel 11
Sector 1 South Channel 74
Sector 2 Channel 71
(54°17'51"N, 130°25'26"W);
- **Victoria** call sign *VAK*
Sector 1 Channel 11
Sector 2 Channel 74
Sector 3 Channel 12
Sector 4 Channel 71
(49°19'32"N, 123°07'56"W).

42 The prime function of MCTS is to provide a ship-shore safety service. Canada is committed to arrange for coast watching and rescue of persons within its coastal area. MCTS Centres provide a ship-shore radio communication link 24 hours a day between shipping and the governmental agencies responsible for carrying out search and rescue operations. Scheduled broadcasts of weather observations and forecasts and information on aids and dangers to navigation are also provided.

43 **Vessel Traffic Services (VTS)** Systems are established throughout Canadian waters. The purpose of these systems is to promote safety of navigation, protection of the environment and expeditious movement of marine traffic. For more information see *Radio Aids to Marine Navigation (Pacific and Western Arctic)*.

44 **Global Maritime Distress and Safety System (GMDSS)** is an international system using satellite and terrestrial communication technologies, as well as the ship's radio communication systems. Developed by the International Maritime Organisation (IMO) and implemented at the global level since February 1999, the aim of GMDSS is to save lives. Land based SAR resources and ships in the vicinity can be rapidly alerted thus increasing chances of finding mariners in distress.

45 GMDSS has an impact on all Canadian vessels equipped with a radio, regardless of their size. Since April 2002, ships of 8 m in length and more and operating 20 miles and more offshore must be equipped with an EPIRB (Emergency Position-indicating Radio Beacon). Since February 2003, tow boats, ships carrying more than six passengers, and decked ships of 8 m in length and more, must carry a VHF DSC (see next section) when operating outside an MCTS area.

46 Mariners are strongly advised to contact Transport Canada Marine Safety Directorate offices for communications equipment carriage requirements relating to GMDSS.

47 Even though four international maritime areas (A1, A2, A3 and A4) are defined by GMDSS, Canada has chosen to implement radio services only for the A1 (East Coast and West Coast), A3 (offshore waters of these areas) and A4 (in the Arctic) areas. MF DSC is not available in Canada though coastal radio stations maintain a radio watch on 2182 kHz. Canadian GMDSS areas are:

- Zone A1 – corresponds to the area covered by the VHF DCS (40 miles from the coasts);
- Zone A3 – covered by the Inmarsat geostationary satellites (within the 70°N and 70°S parallels), excluding Zone A1;
- Zone A4 – zones not covered by A1 and A3 (Polar Regions).

48 MCTS Centres will continue to monitor VHF Channel 16 (156.8 MHz) for distress, urgency, safety and calling purposes for the foreseeable future. Mariners should conform to international procedures and the use of designated frequencies. If transmission on international distress frequencies is not possible, any other frequency on which attention might be attracted should be used.

49 **Digital Selective Calling (DSC).** — For most areas of the B.C. coast a DSC equipped radio can instantly transmit a distress call. Information such as vessel description, name and home contact are pre-programmed and broadcast to the Canadian Coast Guard. Connection to GPS also allows position information to be transmitted. DSC coverage is limited to the range of the VHF radio and a Maritime Mobile Service Identity (MMSI) number is required. The MMSI number should not be confused with obtaining a radio station licence (which is no longer required for pleasure craft).

50 A properly installed and registered DSC radio could help save your life. The Coast Guard urges you to complete the [application form](#) for recreational boaters or call Industry Canada at 1-800-667-3780 for more information. Your completed application form can be either faxed or e-mailed to your local Industry Canada Office.

 51 **Do not test this Distress Alerting feature.** There is no test feature and it is an offence under both the *Canada Shipping Act* and the *Radiocommunication Act* to send a false distress message.

52 **Cellular Telephone Marine Emergency Service #16 or *16.** — MCTS Centres in certain parts of Canada are connected to the cellular telephone network system. In an emergency situation cellular telephone users can dial #16 or *16 to access a MCTS Centre to obtain assistance. **Please note: dial either #16 OR *16 but not both.** Contact your cellular telephone service provider to determine which number they support. Also note that not all cellular telephone companies provide Marine Emergency Service.

 53 **Caution.** — A cell phone is not a substitute for a marine radio. The maritime mobile safety system in southern waters of Canada is based principally on VHF communications. VHF has the advantage that a call can be heard by the closest MCTS Centre and by ships in the vicinity that could provide immediate assistance. The telephone cellular network is a party-to-party system and the benefit of the broadcast mode in an emergency situation cannot be obtained.

54 Use of marine distress frequencies to obtain assistance in an emergency situation is the best option. Cell phones should be used only as an alternative if a VHF radiotelephone is not available.

55 **Notices to Shipping.** — Navigational warnings (NOTSHIP) pertaining to the Canadian waters of British Columbia are broadcast by MCTS Centres at specific times as indicated in the individual station listings given in *Radio Aids to Marine Navigation (Pacific and Western Arctic)*.

56 **Marine weather reports.** — Weather synopsis, area weather forecasts and marine bulletins, for all areas along the British Columbia coast, are broadcast continuously from MCTS Centres and by Environment Canada. Details of marine weather forecast areas and local weather report broadcasts are given in *Radio Aids to Marine Navigation (Pacific and Western Arctic)*.

57 Continuous marine weather information services for Juan de Fuca Strait and the Strait of Georgia are recorded on tape and are continually updated. They can be obtained by telephoning (250) 363-6492/6880. For access to marine weather forecasts in other areas see the Environment Canada web site at http://www.weatheroffice.ec.gc.ca/marine/region_03_e.html. If you need to speak to a weather forecaster

when onshore call 1-900-565-6565 or 1-866-640-6369 (fees apply).

58 **Direction finding.** — Any Canadian Coast Guard MCTS Centre will on request transmit signals to enable a ship to take a radio bearing with its own direction finder.

59 **Radio medical advice** can be obtained with assistance from the nearest MCTS Centre. Telephone patches via VHF radio can provide medical advice. In emergency situations medical evacuations can be arranged.

60 **Time signals.** — Canada's official time is the responsibility of the National Research Council's CHU with transmitters at $45^{\circ}18'N$, $75^{\circ}45'W$. It is equipped with vertical antennas to give the best possible coverage to the maximum number of Canadian users. The signal is transmitted continuously on 3330 kHz, 7335 kHz and 14670 kHz upper sideband H3E (AM compatible).

61 Carrier frequencies and second pulses are derived from a cesium atomic clock and hence are stable to a part in 10^{11} . The second pulses consist of 300 cycles of a 1000 Hz tone, with certain omissions and identifications. Omission of the 29th pulse identifies the half minute and omission of the 51st to 59th provides a window for the voice announcement. Zero pulse of each minute is one half second long, and the hour is identified by a pulse of one full second followed by nine seconds of silence. The bilingual voice announcement is heard each minute.

62 **Channel 9** (27.065 MHz) is for emergency communications by those with General Radio Service (Citizen Band) radios. Channel 13 (27.115 MHz) may also be pre-empted for use in marine emergencies. However, the following should be kept in mind by users of this frequency:

- (a) The combination of low power and line-of-sight range severely limits the effectiveness of a distress call;
- (b) This frequency is not monitored by Canadian Coast Guard cutters or by MCTS Centres;
- (c) The most likely prospect of a call reaching the Joint Rescue Co-ordination Centre (JRCC) is for it to be intercepted by another General Radio Service operator who is able to relay the call on 2182 kHz or by land line telephone.

63 The function of Channel 9 seems to have been rather widely misunderstood. Amendments to the *General Radio Regulations, Part II* include the following provision in Section 72 representing the General Radio Service:

(2) Licensed stations may use the frequency of 27.065 MHz for radio communications that concern only the immediate protection of lives or property.

64 The intention of the regulation is to reserve Channel 9 for communications in case of emergency only.

65 **Marina frequency.** — British Columbia coastal marinas monitor **Channel 66A**.

66 **NAVTEX** on board ships is a unidirectional communication system i.e. it receives but can't transmit. It prints Maritime Safety Information (MSI) which is issued by CCG. It is available through Prince Rupert MCTS on a frequency of 518 kHz. Broadcast times and content are listed in *Radio Aids to Marine Navigation (Pacific and Western Arctic)*.

67 **INMARSAT** allows communications by telephone (INMARSAT A and B only) and by teletex anywhere in the world, except Polar regions. INMARSAT system will be used for the distress calls as well as for MSI and the communications with the coastal facilities in the areas where there are no VHF, or MF/HF DSC facilities.

68 INMARSAT-A services will be withdrawn on 31 December 2007. Mariners should plan accordingly to ensure maritime communication requirements for their particular vessel are addressed beyond this date.

69 **Radiobeacons.** — Marine radiobeacons operate in the frequency band 285–325 kHz. Continuously operating radiobeacons normally transmit a continuous carrier modulated by a 1020 or 400 hertz tone. The tone is keyed at fixed intervals to provide the identifying Morse characteristic. Details regarding radiobeacons are given in *Radio Aids to Marine Navigation (Pacific and Western Arctic)*.

70 Radiobeacons are located at:

- **Active Pass**, Strait of Georgia ($48^{\circ}52'26''N$, $123^{\circ}17'23''W$);
- **Dead Tree Point**, Hecate Strait ($53^{\circ}21'01''N$, $131^{\circ}56'23''W$);
- **Masset**, Dixon Entrance ($54^{\circ}01'54''N$, $132^{\circ}07'38''W$);
- **Prince Rupert**, Chatham Sound ($54^{\circ}15'49''N$, $130^{\circ}25'20''W$);
- **Sandspit**, Hecate Strait ($53^{\circ}11'48''N$, $131^{\circ}46'33''W$);
- **Tofino**, West Coast Vancouver I ($49^{\circ}02'54''N$, $125^{\circ}42'16''W$).

 71 **Mariners are cautioned regarding the limitation of radiobeacons and receiving equipment, and the possible erroneous bearings that may result. Danger may arise from the misuse of radiobeacons in fog. No attempt should be made to home on a radiobeacon station while relying on hearing a sound fog signal from the same station in time to alter course to avoid danger.**

72 **Automatic Identification System (AIS)** is a communications system developed with guidelines from the International Maritime Organization (IMO), International Telecommunication Union (ITU) and International Electrotechnical Commission (IEC). Elements of shipboard AIS include data display equipment, AIS-compliant data sentence assembly and communication units.

73 The IMO Performance Standards for AIS [IMO Resolution MSC.74(69)] (IMO 2002b) require that systems be capable of functioning:

- In ship-to-ship mode, to assist in collision avoidance;
- In ship-to-shore mode, as a means for maritime nations to obtain information about a ship and its cargo;
- In ship-to-ship mode, as a vessel traffic service (VTS) tool.

74 AIS transponders use GPS technology to transmit ship identification and voyage information to other ships and to coastal shore-based authorities for safety and security purposes. SOLAS Chapter V Regulation 19 – Carriage requirements for ship borne navigational systems and equipment – outlines navigational equipment to be carried on board ships, according to ship type.

75 AIS propagation is slightly better than radar because of its longer wavelength. This is a particularly helpful feature for some waterways where land masses are common. At sea, the typical range for coverage is expected to be about 20 nautical miles. The ITU has designated two dedicated frequencies for AIS: 161.975 MHz marine band Channel 87B and 162.025 MHz (Channel 88B).

76 **In Canada** MCTS Centres use AIS to monitor vessel traffic movement.

77 The Canadian Coast Guard issued a mandatory AIS carriage requirement for all ocean-going and lake vessels transiting the St. Lawrence Seaway beginning March 25, 2003.

78 **In the United States** effective April 1, 2005 all vessels over 300 gross tons bound for an American port must be equipped with AIS. Any vessels without AIS capability must request a letter of deviation from the Captain of the port of entry prior to entry and have AIS operational prior to departure.

79 Implementation of AIS in United States waters has prompted the U.S. Coast Guard to issue a number of advisories:

- Users are not updating their unit to accurately reflect voyage related information such as navigation status, static draft, destination and ETA, etc. Due diligence on behalf of the user is required;
- AIS units that either do not transmit at all or improperly transmit the vessels dynamic data such as position, course, speed and heading etc. Improper installation or operation of external sensors such as gyro and GPS are the most likely cause;
- AIS data can be invaluable however as with any source of navigation information it should not be solely relied upon in making navigational and collision avoidance decisions;

- While AIS allows for safety related ship-to-ship text messaging to communicate with others and make passing arrangements, these communications do not meet regulatory requirements nor do they relieve a vessel operator from the Navigation Rules requirements to sound whistle signals or display lights and shapes.

Radar

80 **Radar beacons** are fitted to some of the more important light structures and buoys in British Columbia waters. A Racon responds to radar transmissions with a signal on a ship's radar display consisting of a line that starts at the approximate range of the Racon and extends toward the outer edge of the display, along the line of bearing from the ship. The signal display may be a solid line or it may be broken into Morse code dots and dashes according to the identification published in *Radio Aids to Marine Navigation (Pacific and Western Arctic)*. Two types of Racons are in use.

81 **Slow sweep Racons** sweep periodically through marine radar X band (9320–9500 MHz). The Racon signal is presented on the radar display only when the transmitter frequency passes through the narrow band width of the ship's radar receiver. This results in a short presentation time (1–3 antenna scans), with a long time delay (72 to 120 seconds), between presentations.

82 **Frequency agile Racons** measure the frequency and signal strength of the interrogating radar pulse then tune their transmitter to that frequency before responding. While it is possible for a response to be displayed on each antenna scan of every radar within range, in actual practice these Racons are programmed to turn off at regular intervals to prevent masking other echoes. The frequency agile Racon can be set up to respond to both X band and S band (3000 MHz) radars, but is normally set up only for X band.

83 Positions of Racons are shown on Canadian charts. Should a Racon fail to give a response to a ship's radar, this fact should be reported immediately to the nearest Coast Guard MCTS Centre so the information can be broadcast as a *Notice to Shipping*.

84 **Radar reflectors** are fitted to many buoys and some light structures to provide a more effective reflector surface to the aid upon which they are fitted, to increase the strength of the returned radar signal.

85 Operators of vessels less than 20 m in length or vessels constructed primarily of non-metallic materials are required by the *Canadian Collision Regulations* to fit a passive radar reflector if it is practicable and necessary for the safety of the vessel. Radar reflectors are obtainable from most chandlers.

86 **Radar ducting.** — Meteorological factors leading to radio ducting in the lower atmosphere are reasonably well known. Anomalous propagation is caused by steep gradients in temperature and/or moisture content which result in abnormal refraction of radio rays, causing unusually short or unusually long radar detection ranges. In some circumstances, reflection can take place also from the sea or earth surface, or between elevated layers of abnormal refractive index, causing “ducting”. Generally, a wave is coupled into a duct only when the ray angle is within $\frac{1}{2}^\circ$ to 1° of the horizontal. The possibility of a wave being trapped in a duct increases with increasing frequency.

87 Detailed information on the occurrence of ducting off the coast of British Columbia is limited. Computations, based on radiosonde data, suggest that the probability of having a minimum trapped frequency of 3 GHz is less than 2% except in summer months when it may rise to 4%. When ducting occurs it tends to last for several hours. As a result, the year-to-year variations of transmission loss at the small percentages of the time are substantial.

Global Navigation Satellite Systems

88 Global Navigation Satellite Systems (GNSS) include GPS (USA), Glonass (Russia), and Galileo (Europe-UK).

89 The most commonly used satellite navigation system is **Global Positioning System (GPS)**, established by the United States Department of Defence (US DoD). It is sometimes referred to as NAVSTAR.

90 GPS has three components:

- (1) A constellation of satellites orbiting about 20 000 km above the earth’s surface;
- (2) A control segment which maintains GPS through a system of ground monitor stations and satellite upload facilities;
- (3) Users – both civilian and military.

91 Each satellite transmits a unique digital code sequence of 1’s and 0’s precisely timed by a digital clock. This is passively received by a GPS receiver antenna and matched with the same code sequence generated inside the receiver. By lining up or matching the signals the receiver determines how long it takes the signals to travel from the satellite to the receiver. These timing measurements are converted to distance using the speed of light (about 300 000 km/sec), the same speed radio waves travel.

92 By measuring distances to four or more satellites simultaneously and incorporating the exact locations of the satellites (included in the signals transmitted by the satellites), the receiver can determine its latitude, longitude and height while at the same time synchronizing its clock with the GPS time standard. Determining a position from measurements

of distance is known as trilateration, not triangulation, which involves the measurement of angles.

93 GPS provides 24 hour per day global coverage and is an all-weather system not affected by rain, snow, sand or fog.

 94 **Caution.** — GPS makes a direct reading based upon the World Geodetic System 1984 (WGS84), considered as the equivalent of the North-American Datum 1983 (NAD83). Most GPS receivers are equipped with a conversion function for the various Reference Systems. Mariners can choose the system which is compatible with the chart used.

 95 Transports Canada advises to always set the receiver to NAD83 or WGS84, and manually apply correction values printed on the chart. Some CHS charts are still on the older NAD27 horizontal datum reference system. The difference between a NAD27 position and the same position on NAD83 can be 110 m on the Pacific Coast. It is critical to apply the required corrections.

96 **Differential GPS (DGPS)** is regular GPS with an additional correction (differential) signal added. It is used to increase the accuracy of positions derived from GPS receivers. With DGPS receivers, position accuracy is improved from 30 metres to better than 10 metres. The use of real-time corrections transmitted from a reference station within several hundred kilometres will improve accuracy. DGPS provides continuous precise positioning of 10 metres, 95% of the time or better.

97 A GPS receiver can be upgraded to receive DGPS signals only if it has been designed as “DGPS ready”. While many GPS receivers are advertised as differential ready this does not mean the differential receiver is already built into the unit. This is a useful option for those who do not need the more accurate technology immediately. Mariners are advised that differential corrections are based on NAD83.

98 Details on GPS are given in *Radio Aids to Marine Navigation (Pacific and Western Arctic)*, www.navcen.uscg.gov/ and at www.igeb.gov.

99 **GPS point positioning error sources** include:

- **Site** – receiver noise and multi-path errors;
- **Atmosphere** – signal propagation delays due to the ionosphere and troposphere;
- **Satellite** – errors in clock information and broadcast orbits.

100 Whenever the accuracy provided by the reference station falls below established limits a warning signal is automatically transmitted to advise the mariner that the service is unreliable. If the differential signal is lost altogether a DGPS receiver can continue to operate in GPS mode.

101 **Multipath** (or multiple paths) refers to a positioning error resulting from interference between radio waves which

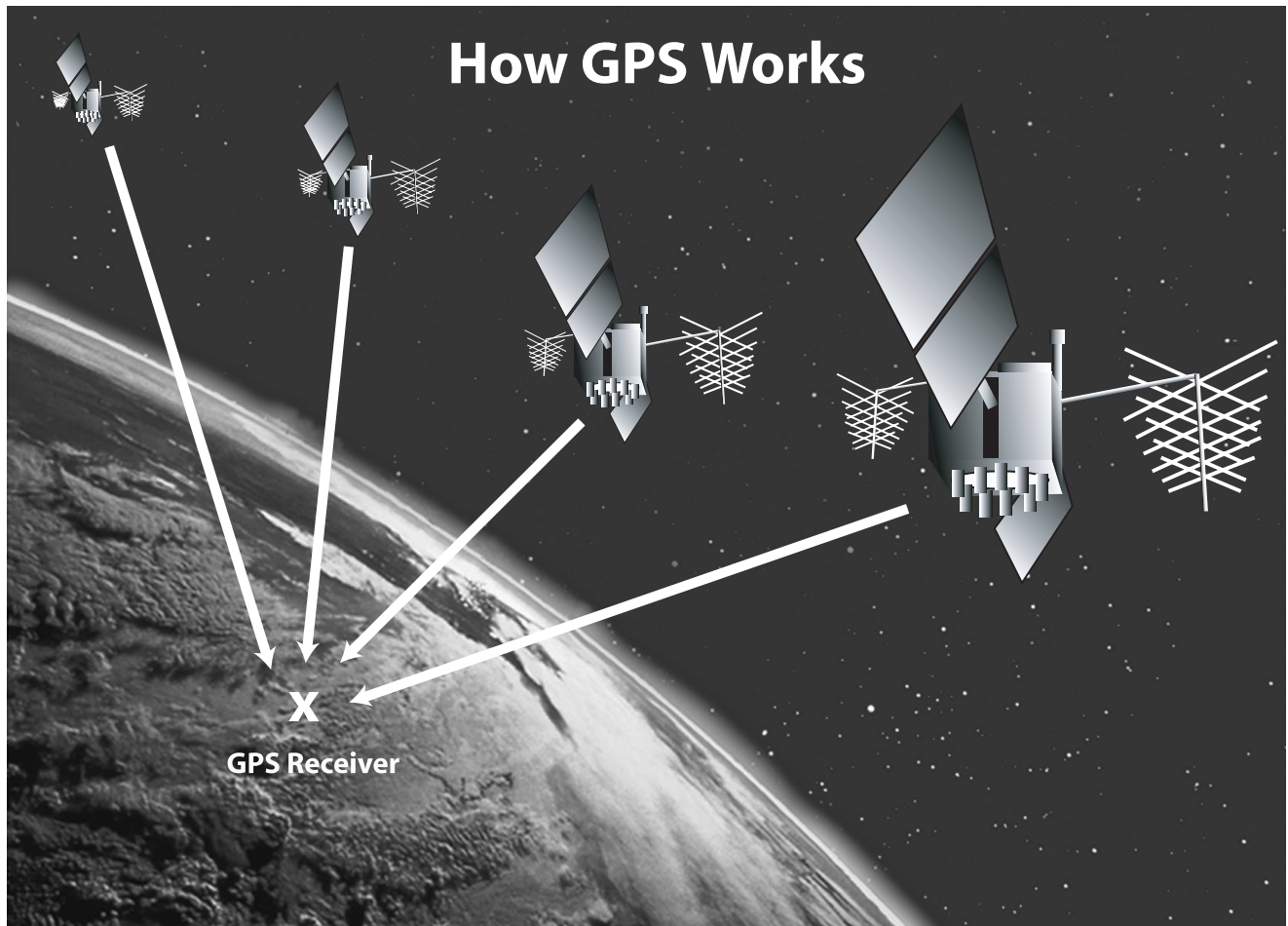

Basic requirements for GPS signal generation

have travelled between the transmitter and the receiver by two paths of different electrical lengths.

102 **Caution.** — Vessels with modern navigational equipment such as Loran-C, GPS or DGPS can navigate with a degree of accuracy and precision that was not available to hydrographic surveyors until recently. Charted positions of islands and other features shown on older nautical charts may not agree with latitude and longitude positions given by modern navigational equipment. Such older charts are generally on an unknown or assumed datum, as noted in the Horizontal Datum note printed on each chart. Positions on such charts should be confirmed by reference to range and bearing of known objects.

103 **Glonass.** — The Global Navigation Satellite System (Glonass) is a radio satellite navigation system operated by the Russian Space Forces for the Russian government. It operates separately from U.S. GPS and Europe-U.K. Galileo.

104 **Glonass** has a total of 24 satellites — 21 operating and three spares placed in three orbital planes. The system provides horizontal positioning accuracy of 57–70 metres and vertical positioning accuracy of 70 metres improved by differential mode. The system is subject to modernization and other improvements. Glonass is proposed to be fully operable in 2007 and to function at full capacity in 2008.

105 **Galileo.** — Galileo is a multipurpose global navigation satellite system under civil control. Key member states involved in development and administration are Germany, France, Italy, Spain and the United Kingdom. Galileo operates autonomously but will be interoperable with GPS and Glonass and is designed to operate with their known planned upgrades. Further to their navigation function, Galileo satellites are designed to downlink distress messages for Search and Rescue to dedicated COSPAS-SARSAT rescue centres.

106 The Galileo constellation comprises 30 satellites — 27 satellites with three operational in-orbit spares. It will offer dual-frequency delivering real-time positioning accuracy

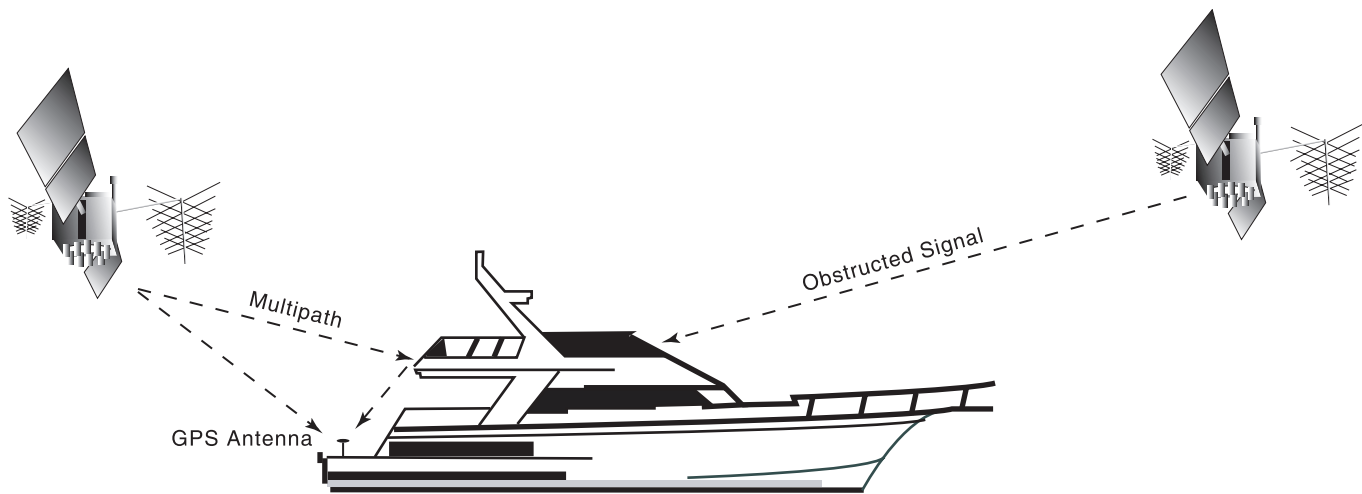

Examples of Obstruction Errors

down to the metre range. The system is proposed to be fully operable in 2008 and to function at full capacity at the end of 2009.

107 By 2010, GNSS receivers will be able to acquire signals from multiple constellations (GPS and Galileo and

possibly Glonass) and provide reliable and accurate (1 metre) positioning without reliance on shore-based correction services. Users will be warned automatically when problems occurs through Receiver Autonomous Integrity Monitoring, or RAIM.

Nautical Publications

CHS Publications

1 Under *Charts and Nautical Publications Regulations, 1995* of the *Canada Shipping Act*, mariners must have the appropriate CHS publications onboard and in use when navigating in Canadian waters. These are:

- The most recent edition of a chart that is issued officially, applies to the immediate area in which the ship is being navigated, and is the largest scale chart for that area;
- The reference catalogue;
- The annual edition of *Notices to Mariners*;
- *Sailing Directions*;
- *Canadian Tide and Current Tables*;
- *List of Lights, Buoys and Fog Signals*;
- Where the ship is required to be fitted with radio equipment, *Radio Aids to Marine Navigation*.

2 The chart may be in **electronic form** only if:

- It is displayed on an ECDIS (Electronic Chart Display and Information System), or in case of the failure of the ECDIS on a back-up arrangement;
- In waters for which an ENC (Electronic Navigation Chart) is available the ECDIS is operated using the ENC;
- In waters for which an ENC is not available the ECDIS is operated using an RNC (Raster Navigation Chart);
- The ECDIS is being used in the RCDS (Raster Chart Display System) mode in conjunction with the required paper charts;
- Accompanied by a back-up arrangement.

3 **The master and owner of a ship of less than 100 tons** are not required to have on board charts, documents and publications if the person in charge of navigation has sufficient knowledge of the following information such that safe and efficient navigation is not compromised:

- Location and character of charted shipping routes, lights, buoys and marks, and navigational hazards;
- Prevailing navigational conditions taking into account such factors as tides, currents, ice and weather patterns.

For more information refer to the Transport Canada web site at <http://www.tc.gc.ca/acts-regulations/GENERAL/c/csa/regulations/010/csa011/csa11.html>.

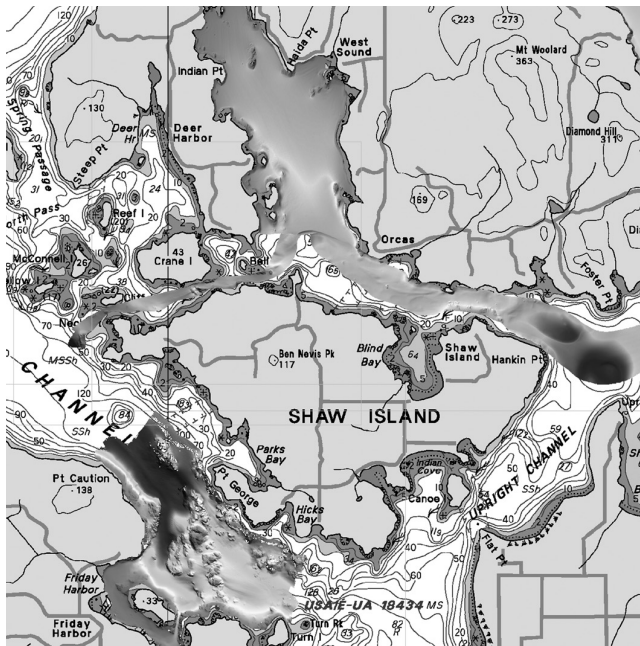

4 **Nautical chart categories.** — CHS charts are issued in the following categories:

- **New Chart** – first publication of a chart covering an area not previously charted to the scale shown, or covering an area different from any existing Canadian chart;
- **New Edition** – new issue of an existing chart containing amendments essential to navigation in addition to those issued in *Notices to Mariners* and makes existing editions obsolete;
- **Reprint** – new printing of the current edition of a chart incorporating no amendments of navigational significance other than those previously promulgated in *Notices to Mariners*. It may also contain amendments from other sources provided they are not essential to navigation. Previous printings of the current edition remain valid.

For more information see the Canadian Hydrographic Service (CHS) web site at <http://www.charts.gc.ca/pub/>.

 5 **Releases of New Charts, New Editions, Reprints and other publications are announced in Section 1 of the monthly edition of *Notices to Mariners*. It is dangerous and a violation of the *Charts and Nautical Publications Regulations, 1995* to continue to use cancelled charts or publications.**

6 A list of all charts showing edition dates of the current editions and reprint dates (if applicable) is published quarterly in the monthly *Notices to Mariners*.

7 **Notices to Mariners.** — Standard nautical charts published by CHS are amended to the date of issue by the Hydrographic Chart Distribution Office in Ottawa, Ontario. Beyond the date of issue, which is clearly stamped on the chart, it is the responsibility of the mariner to ensure that hand amendments are entered on the chart from information promulgated in the monthly editions of *Notices to Mariners*. For more information see <http://www.notmar.gc.ca/>.

8 Small craft charts, and some other charts such as planning charts, are not hand amended and are not stamped with a date of issue. These charts are only corrected to the date of printing and for subsequent corrections *Notices to Mariners* must be consulted.

9 Charts are not amended by CHS for Temporary (T) or Preliminary (P) *Notices to Mariners*. Any (T) or (P) Notices affecting a chart should be noted on the chart in pencil. The Canadian Coast Guard publishes an annual summary of all (T) and (P) *Notices to Mariners* in effect at the beginning of each year. A list of (T) and (P) Notices in effect is also published quarterly in the monthly editions of *Notices to Mariners*.

10 **Temporary Notices to Mariners** are used to describe conditions of a temporary duration (6-12 months) which affect navigation, for example deployment of a temporary buoy. For temporary conditions that are in effect for less than

six months, consult *Notices to Shipping*. In cases where a critical temporary change is in effect for more than 12 months a *Notice to Mariner* may be issued and a subsequent notice issued when the temporary condition no longer exists.

11 **Preliminary Notices to Mariners** are used to give mariners advance information about changes when further information or more permanent action is anticipated. (P) Notices may cause confusion and additional work for mariners and are used only when necessary, for example if:

- Changes affecting navigation are to take place in the near future. A (P) NOTMAR will be published so that mariners will have advanced information on the change. These are usually found in Section 1 of the monthly edition. They are often promulgated as *Notices to Shipping* as well;
- Changes have taken place that are too complex to describe in a written Notice and are too complex for hand amendment. These notices will usually explain that follow-up action will occur by publishing patch corrections, new editions or new charts. These are usually found in Section 2 of the monthly edition;
- Changes in conditions affecting navigation have taken place but full information is not available. These notices will usually be followed by regular NOTMAR action when complete information becomes available. This regular NOTMAR will cancel the (P) Notice and is usually found in Section 2 of the monthly edition.

12 **Raster ENC (Electronic Navigational Charts)** are electronic images of the paper chart and provide the same information. Supplementary navigation software allows GPS interface which provides real time position information and shows a vessel icon in relation to its intended track. The user may also enter way points and have other navigation functions such as computing times and courses. Raster data is usually available on CD ROM.

13 **Vector ENC**s are produced in the international standard S57 format and contain additional attribution that is not available on paper charts or raster ENC. The vector system can identify a wharf, for example, and attach attributes to it such as height, length, age, and ownership. This data might otherwise be available only by consulting the relevant *Sailing Directions*.

 14 **It is necessary to ensure that ENC data is maintained and up-to-date. Electronic data providers will usually have an update service allowing clients to download updates. However, mariners are cautioned that updates may not coincide with those issued in the monthly edition of *Notices to Mariners*.**

15 **It is possible for paper, raster and vector charts of the same area to show different data for the same features. It does not necessarily follow that ENC data is the most up-to-date.**

16 **Catalogues of Nautical Charts and Publications** are available in printed and digital formats. They illustrate chart coverage, show related publications, and list CHS chart dealers in Canada and other countries. They are available free of charge. Canadian catalogues are:

- 1 *Atlantic Coast*
- 2 *Pacific Coast*
- 3 *Ontario/Manitoba*
- 4 *Arctic*

17 **Chart No. 1 Symbols Abbreviations and Terms** is a booklet listing the symbols, abbreviations and terms used on Canadian charts. It is a useful tool for new chart users as well as experienced mariners. *Chart No. 1* is now available in the following formats:

- Free on the web
- CD ROM
- Printed booklets

18 **Sailing Directions** are books that supplement information given on charts. They contain general information for navigation as well as coastal descriptions, geographic information and detailed descriptions of port facilities. *Sailing Directions* are intended to be read in conjunction with charts quoted in the text.

19 Critical amendments between new editions of *Sailing Directions* are promulgated in Section IV of the monthly editions of *Notices to Mariners*. Annual summaries of *Notices to Mariners* for each specific volume of *Sailing Directions* are available on request to CHS.

20 When using *Sailing Directions* mariners should ensure that all amendments since publication have been entered. The publication of new editions of *Sailing Directions* is announced in the monthly editions of *Notices to Mariners*.

21 **Canadian Tide and Current Tables Volumes 5, 6 and 7** cover tidal waters of British Columbia as follows:

- *Volume 5 — Juan de Fuca Strait and Strait of Georgia;*
- *Volume 6 — Discovery Passage and West Coast of Vancouver Island;*
- *Volume 7 — Queen Charlotte Sound to Dixon Entrance.*

22 *Tide and Current Tables* are published annually and contain twelve months of daily tide predictions for all Canadian reference ports. Time and height differences for secondary ports are also provided. Daily current predictions are included for selected current stations.

23 The Tables are necessary for obtaining depth of water under the keel for anchoring, and for establishing the appropriate time for passage under bridges, launching, hauling and performing maintenance on vessels. They provide valuable information for recreational purposes such as beachcombing and tide pool exploration.

24 Current information is required when navigating narrow passages or channels that have strong currents and for safety considerations when the wind is against the current. In such circumstances steep waves may be generated that can be very dangerous to small craft.

25 Datum of predictions given in the *Canadian Tide and Current Tables* for both reference and secondary ports is, unless otherwise stated, the same as chart datum in that area.

26 Datum for United States Tide Tables and Charts is based on Mean Lower Low Water, which is a different datum to that used in Canada. It is therefore important to use a Canadian reference or secondary tidal port in Canadian waters and a United States reference or secondary tidal port in United States waters.

27 Tide, current and water level data is also available on the CHS web site at <http://www.waterlevels.gc.ca/english/Canada.html>.

28 **Current Atlas, Juan de Fuca Strait to Strait of Georgia** covers waters between Sooke and Campbell River including the Gulf and San Juan Islands. The Atlas, used in conjunction with *Canadian Tide and Current Tables, Volume 5*, contains diagrams illustrating where to expect strong tidal streams or large eddies, as well as surface currents caused by discharge from the Fraser River. Mariners will find the *Current Atlas* useful when planning a cruise or when racing.

29 **Where to buy.** — Charts and related publications can be purchased at over 800 authorized chart dealers throughout Canada, the United States, Europe and Asia. Chart dealers are required to stock charts and related publications for their immediate geographic area and to accept orders for any chart or related publication that a mariner requests.

30 **Digital data** at survey scale may be available for certain areas for specialized applications. Clients with a need for more detailed information, usually at a larger scale than shown on the chart, should contact CHS and digital data distributors for further information.

Nautical Charts

31 **Horizontal Datum** is a reference system for specifying positions on the earth's surface. All CHS nautical charts have a horizontal datum note in the title identifying which datum the chart is on and may also contain information about the corrections to be applied to the geographical positions to convert them to the international reference system or the internationally recognized regional datum.

 32 **It is critical to ensure that the horizontal datum setting on any GPS receiver matches the horizontal datum of the chart in use. Failure to do so may**

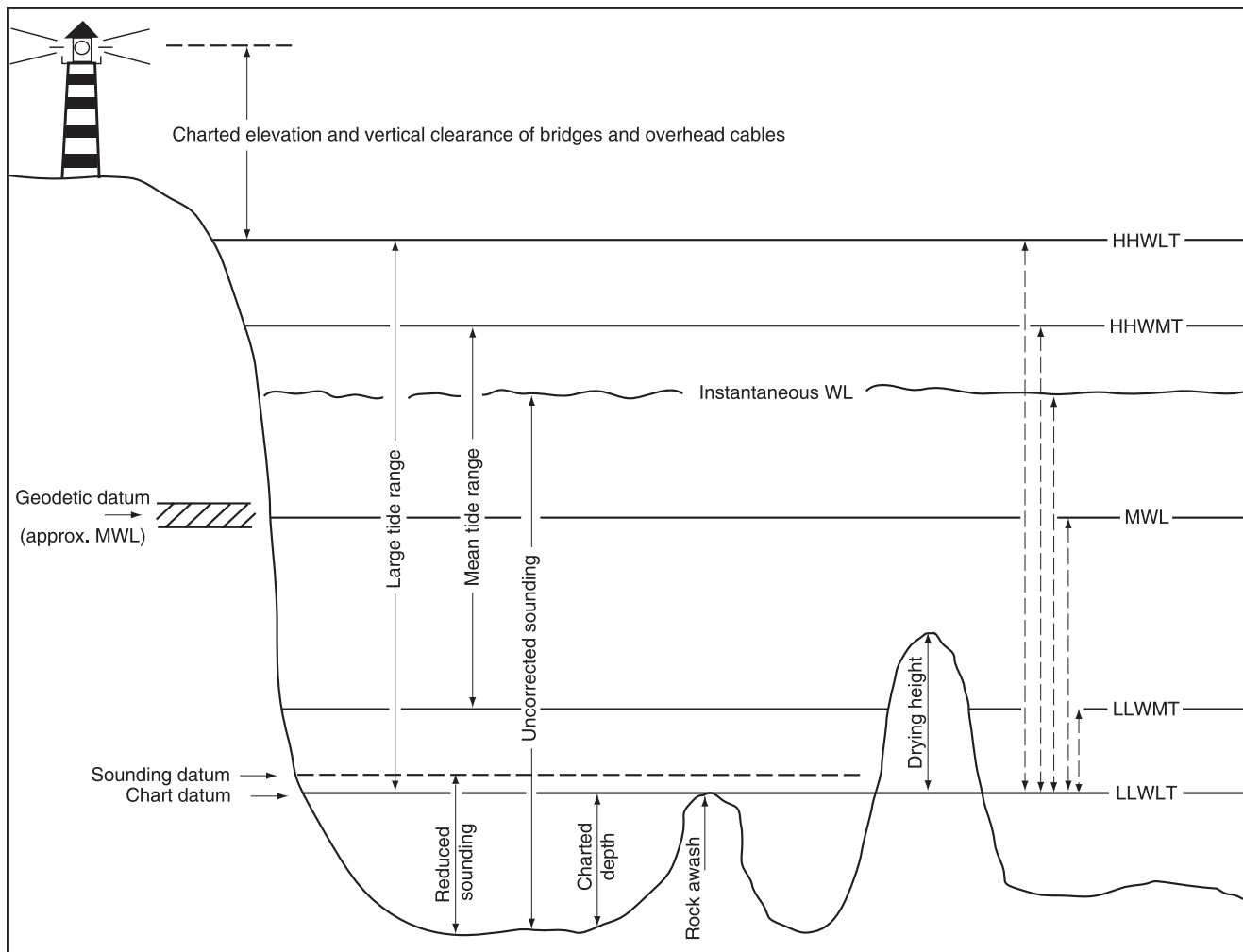

Relation between tidal surfaces, charting datums and physical features.

result in significant position discrepancies that could result in serious accidents.

33 The following horizontal datums may be found on CHS charts:

34 **Unknown Datum.** — A few charts based on old surveys may be on a horizontal datum that cannot be accurately determined. In these cases relative position fixing methods such as range and bearing should be used and electronic positioning systems such as GPS should not be used. These charts will usually have a special warning note on them.

35 **NAD27.** — Charts on the older North American Datum 1927 can be used with electronic positioning systems as long as positions are converted, or the appropriate datum setting is used on the GPS receiver. For the B.C. coast the difference between NAD27 and NAD83 is approximately 120 m. The difference increases the further north and west a vessel travels.

36 To convert GPS-derived NAD83 positions to be able to plot them correctly on NAD27 charts usually requires:

- the addition of approximately 0.7" of latitude to the NAD83 position;
- the subtraction of approximately 5.0" of longitude from the NAD83 position.



37 **The examples provided above are for reference only and should not be used for navigation. Use values provided in the chart title only.**

38 **NAD83.** — CHS is producing all New Charts on this datum and converting all existing charts when New Editions are published. NAD83 is equivalent to WGS84 allowing GPS derived positions to be compatible with the chart.

39 **Vertical Datum** used for Canadian nautical charts depends on whether the chart is of tidal or non-tidal waters.

40 **On charts of tidal waters** two vertical datum are referenced:

- A low water datum, Lowest Normal Tide, is used to reference soundings and drying heights;
- A high water datum, Higher High Water, Large Tide, is used to reference elevations and clearances of overhead structures.

41 Only rarely will the water level fall below Lowest Normal Tide or rise above Higher High Water, Large Tide and therefore only rarely are actual depths and clearances less than those indicated on the chart.

42 **On inland (non-tidal) waters** depths are usually referenced to chart datum below which the water level will seldom fall. Elevations may be referenced to chart datum or a High Water datum a few metres above chart datum. Land contours and spot elevations taken from topographic maps are referenced to Geodetic datum. Depths and elevations notes in the chart title should be consulted for further information.

43 Most inland charts also have a hydrograph. This is a graph showing monthly mean water level changes in relation to chart datum. Mariners can use these values to determine more accurate values for the time they are navigating in the area.

44 **Lowest Astronomical Tide.** — CHS will be converting charts to Highest Astronomical Tide (HAT) for high water datum and Lowest Astronomical Tide (LAT) for low water datum in the near future. The purpose is to meet international standards for ensuring consistency between individual national hydrographic authorities.

45 HAT is the highest water level and LAT is the lowest water level that can be expected under average meteorological conditions and under any combination of astronomical conditions. They are not extreme levels as some extreme conditions may cause higher or lower levels.

46 For Canada's Pacific coast the differences between currently used high and low water datum and LAT/HAT is small and mariners will see little or no difference in charted values.

47 **Metric and imperial unit charts.** — CHS is converting all charts to the metric system. Mariners should pay particular attention to whether the soundings on a chart are shown in fathoms, feet, or metres.

48 **Chart reliability.** — The value of a chart largely depends on the accuracy and detail of the surveys on which it is based. The date of the survey, or a statement of the authorities on which a chart is based, is given under the title of the chart. This information should be reviewed to allow chart users to become familiar with the chart source data prior to navigating in a particular area.

 49 **Mariners are cautioned that when a chart is compiled from several sources, the dates and areas of the surveys may be difficult to define. For this reason new charts and some new editions will have a source clas-**

sification diagram to illustrate the type of survey data used in the construction of the chart.

50 **Source Classification Diagram** contains important information concerning source data used in construction of a particular chart. The following information is provided:

- **Area** – allows the mariner to cross reference the geographic area shown in the pictorial representation of the chart to the information in the table;
- **Origin** – determines who was responsible for surveying the area;
- **Date** – determines when the area was surveyed which in turn determines the survey techniques used and the accuracy and amount of bottom coverage provided by the data. For more information see the Chart source data section below;
- **Line Spacing** – a measure of the distance between lines of data collected by an echo sounder equipped survey vessel. Line spacing determines the amount of the bottom that has been examined. It is a function of the complexity of the bottom and water depth. Lines spaced closer together provide more bottom coverage and less danger of undetected shoals existing. Lines spaced further apart provide less bottom coverage and a greater danger of undetected shoals;
- **Additional notes** – may indicate existence of lead line survey data or full bottom coverage multi-beam data.

51 **Chart source data.** — Depths measured by **leadline** began as the primary method of data collection and continued to be used until the development of electronic echo sounders in the mid 1930s. Depths may have been read to the nearest fathom, quarter fathom or foot depending on the depth of the water. While the quality of the data collected with leadline was reasonable the quantity of data gathered was not. Sufficient seafloor coverage was not obtained the requirement for representative bottom coverage lead to developments of other data collection methods.

52 If a Source Classification Diagram is not present the appearance of the chart and the survey date should allow the mariner to determine which charts still contain less reliable leadline data. Soundings often appear in straight lines or tracks and have a larger number of bottom samples associated with non-shoal soundings. Depth values are often in fathoms and fractions.

53 Positions during this era would have been mostly collected using sextant type technology. Accuracy is not as good as with more modern positioning systems and is only reliable relative to local survey control. Absolute accuracy may be poor and result in charts on an unknown datum.

54 **Single-beam echo sounders** were used to collect depths from the mid 1930s to the mid 1990s. The reasonably wide beam width of early echo sounders provided a much

SOURCE CLASSIFICATION DIAGRAM/DIAGRAMME DE CLASSIFICATION DES SOURCES			
Area/Zone	Origin/Origine	Date	Line Spacing/Espacement des lignes
a	CHS/SHC	1994-96	*
b	Govt	1990	5m
c	CHS/SHC	1993	50m
d	CHS/SHC	1975-84	50m
e	Govt	1997	60m
f	CHS/SHC	1974-79	70m
g	USA/É-UA	1959	80m
h	CHS/SHC	1984-85	100m
i	CHS/SHC	1968	150m
j	CHS/SHC	1968-83	200m
k	USA/É-UA	1959	250m

Govt - federal or provincial government/gouvernement fédéral ou provincial
* Full bottom coverage/entière couverture du fond

Source Classification Diagram

larger footprint on the seafloor than possible with a leadline, increasing the likelihood of discovering shoals to either side of the survey line. In addition, because the echo sounder can take depths much more rapidly than could be done with a leadline, the likelihood of detecting a shoal along the survey line in most cases is 100%. However, unless each beam footprint is overlapped by the footprint on the next line there is a possibility that shoals between lines may not be detected.

55 Positions during this era would have been collected using a number of methods including theodolite and electronic distance measuring equipment, in range-range and range bearing modes. Position accuracy is significantly increased

and survey control improvements provide good absolute positioning in most cases.

56 Since the mid-1990s **multi-beam echo sounders** have been used extensively in surveys. These systems offer the best attributes of the above systems: high accuracy, fine resolution of seafloor features, and complete seafloor coverage. It is unlikely that a shoal is undetected during multi-beam surveys. There is a very small likelihood that mast-like features such as a submerged piling, deadhead or mast of a wreck may go undetected. Where wrecks are detected by the multi-beam echo sounder, confirmation of existence, depth and location of a mast is normally by diver.

SOUNDING METHODS

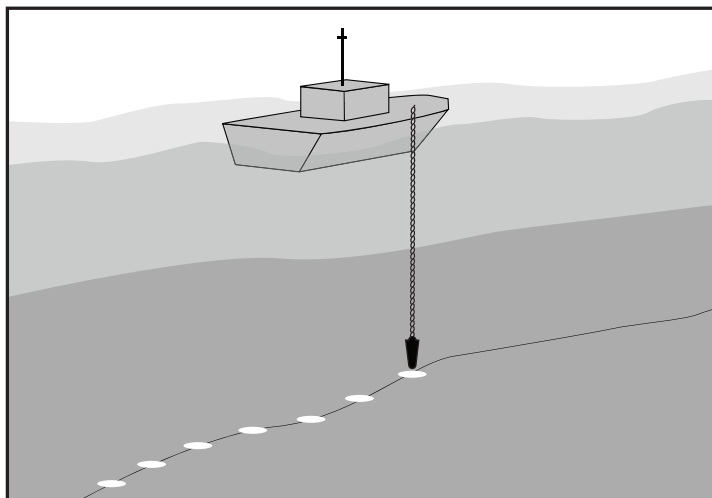

LEADLINE SOUNDING

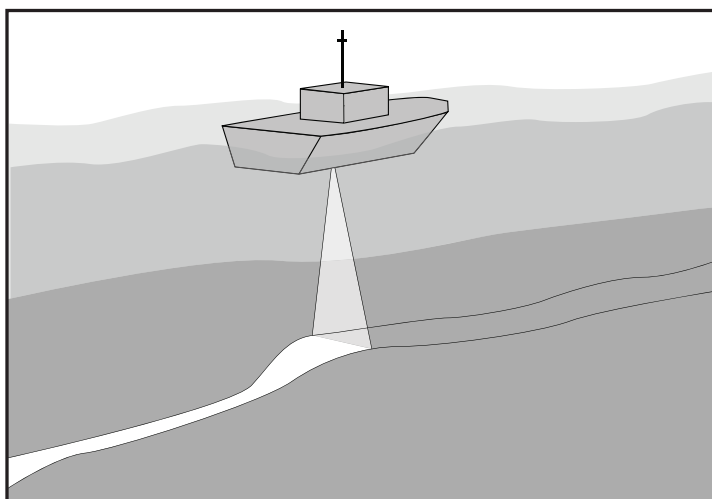

SINGLE-BEAM SOUNDING

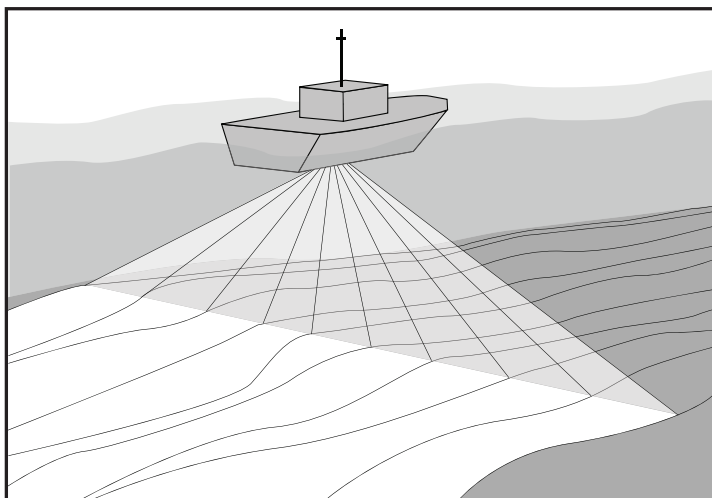

MULTI-BEAM SOUNDING

57 Positions during this era would be derived from GPS technology usually augmented with differential positioning for increased accuracy.

58 **Data on which CHS charts are based come from varied sources**, time periods and survey techniques. Most of the soundings, contours, shoreline, foreshore and offshore hazards on charts have been compiled from CHS hydrographic surveys. There are still a few areas, mostly remote, where no survey data exists at all. These areas are indicated by white space on the chart, often with pecked lines indicating approximate shoreline.

59 In some navigable waterways that are the responsibility of the Canadian Coast Guard to maintain, hydrographic surveys may have come from contract surveys conducted by qualified hydrographic survey companies or other government agencies. The technology and the methodology used for these waterways surveys meet or exceed the standards used on regular CHS surveys.

60 Regardless of who collected the survey data, a reasonable characterization of the accuracy and reliability of the resultant chart can be made by looking at the era of the survey and the area in which it was conducted. Technology for positioning depth soundings, for measuring those depths and for ensuring a complete coverage of a survey area in between survey lines can be inferred in general terms from the age of the survey, i.e. the date the survey was conducted. Similarly, methods used to position and describe the shoreline and foreshore have evolved over the last century.

61 The **appearance of a chart** may show the thoroughness of the surveys on which it is based. Note that a chart drawn from an old survey with few soundings may have had further soundings added to it later from ships' tracks on passage, thus masking the inadequacy of the original survey. The quality of a chart is not shown only by the number of soundings. New metric charts based on recent surveys may show more depth contours and fewer soundings, and some metric charts show information from old charts converted to metres. It is important to use the source classification diagram to assess a chart's reliability.

 62 The chart represents general conditions at the time of the original survey and also includes any changes reported to the Canadian Hydrographic Service before the edition date shown on the chart. Areas where sand or mud prevail, especially in the entrances and approaches to rivers and bays, are subject to continual change. **Extra caution is necessary in such areas.**

63 In regions where reefs and rocks abound it is always possible that surveys may have failed to find every obstruction. When navigating in such waters customary routes and channels should be followed, and avoid waters where irregular and sudden changes in depth indicate conditions associated with reefs and pinnacle rocks.

64 The maximum draught of vessels at the time of the survey should also be considered. Draughts of 15 m were considered a maximum until about 1958. For today's ships of normal draught in much-frequented waters, the reliability of most charts based on early surveys has been confirmed by the safe passage of ships over the years. Vessels with draughts approaching 30 m should exercise care within the 200 m line in less than adequately surveyed areas, even on recognized shipping lanes. In many instances, ships with draughts approaching 30 m may be testing the chart despite the fact that shallower-draught ships may have passed previously. A ship travelling into any unfrequented waters may also be testing the chart for the first time and should exercise due caution.

65 The largest scale chart of an area, with the exception of those charts specifically designed for the use of pleasure craft, should always be used for navigation because dangers to navigation cannot be shown with the same amount of detail on small-scale charts. In addition, because of production priorities only the largest scale charts incorporate information from a new survey.

 66 **Caution. — Some low priority areas in British Columbia have only been roughly examined. Remain vigilant in these areas for detached boulders from broken shores and for rock pinnacles. Whenever a broad and clear channel is accessible it is unwise to use, without need, one that may present undue risk in passage, even if it offers an apparent saving in distance.**

67 **Reporting hazards and providing feedback to CHS. — All mariners are encouraged to provide feedback to CHS regarding all navigation products. This is especially important for any information that may affect navigation safety such as uncharted shoals and shipwrecks.**

68 A *Marine Information Report* form is provided in the Appendices. A *Marine Information Report and Suggestion Sheet* is provided at the back of every monthly edition of *Notices to Mariners*. All information received is carefully assessed and action taken as required. Critical information may be promulgated by *Notices to Shipping* or *Notices to Mariners*. Information of a less critical nature is processed and retained for incorporation in the next New Edition.

69 **Ensure information provided is complete as possible.** Details such as the time and date, type of positioning system used, an accurate description of the feature and contact information are critical in ensuring that appropriate and accurate product amendments can be made. The common availability of GPS for accurate positions and digital cameras can make providing this information easy.

70 Reports concerning safety to navigation should be made as quickly as possible to the nearest MCTS centre for potential *Notices to Shipping* action. Detailed information should then be sent to:

Canadian Hydrographic Service
9860 West Saanich Road, PO Box 6000
Sidney, B.C. V8L 4B2
Tel: (250) 363-6358
Fax: (250) 363-6841
E-mail: chsinfo@dfo-mpo.gc.ca

71 **Chart production processes.** — A brief description of the chart production process is useful in order to understand the capabilities and limitations of this important navigational tool. Generally speaking production of any CHS product follows a number of similar steps.

72 **Production planning** occurs on an ongoing basis. The status of existing products is assessed against the need to update the information shown because of changes to natural conditions, shipping facilities, regulatory requirements, client needs and technological change. The amount of resources available to make the changes is then considered and a constantly evolving production plan developed and implemented. This plan determines which products are to be worked on and when they will be produced.

73 **Data gathering** is the next step in the chart production process. This includes using existing data such as plans submitted under the *Navigational Waters Protection Act*, topographic data from the National Topographic System maps and Provincial Government sources, client feedback and CHS and other survey data. New data may be specially acquired to ensure that the latest information possible is available for chart production. This includes data collected by CHS survey, geo-referenced air-photo and satellite imagery.

74 **Data validation and selection (compilation)** is the process in which data available is assessed. Information to be used in production of the chart is digitized and transformed to chart scale and projection. Most source data used is of a larger scale than the chart which ensures accuracy and the appropriate level of detail is available. Information to be shown on the final chart is then selected. Only a small portion of the data collected can be shown on the final chart due to scale and clarity considerations.

75 **Data presentation (drafting)** is the process where selected information is transformed into the standard presentation shown on the final chart. Additional information such as notes, titles and compass roses are added at this stage. A great deal of skill and expertise is required to ensure that data required for safe navigation is presented in a clear and easy to read format.

76 **Checking** occurs at several stages during the chart production process and involves review by a number of subject matter experts. This is a very lengthy and painstaking process to ensure that every single piece of information shown is as correct as possible, and presented in the best possible way to ensure safe navigation. All information is checked against the

original source data. Changes are then made and verified as necessary.

77 **ENC production** of both raster and vector format data is planned to coincide with the release of paper products as closely as possible. Vector data production requires additional coding and creation of international ENC standard S57 format objects. These objects are thoroughly checked to ensure they are correct and meet standards. Raster data production requires transformation of data into raster format and checking to ensure data is correct.

78 **Publication** occurs when final checks have been completed and all necessary amendments verified as having been made correctly. Data is published in a variety of paper and electronic formats in order to meet as many client requirements as possible.

79 **Magnetic variation.** — CHS charts have compass roses that show True and Magnetic North, as well as the local magnetic variation and its annual change. Isogonic lines (lines of equal magnetic variations) are printed on certain charts. When using magnetic courses or bearings, allowance must be made for the gradual changes in variation. The magnetic compass roses on charts will in time become slightly in error, and on small scale charts the variation may also change from one side of the chart to the other side.

80 **International charts** covering the world at scales of 1:3½ million and 1:10 million are being compiled by some member states of the International Hydrographic Organization. These charts can be reprinted by any member state in its own national series. Each chart carries its international number as well as any national number allocated to it.

81 International charts of waters surrounding Canada are being reprinted in the Canadian chart series as they become available. Being part of the Canadian series, these charts will appear in the Canadian Chart Catalogues and will be corrected by *Notices to Mariners*.

CCG and Other Publications

82 **List of Lights, Buoys and Fog Signals** is published in four volumes every two or three years. The *Pacific Coast List of Lights, Buoys and Fog Signals* covers coastal waters, rivers and lakes of British Columbia. Corrections to the List of Lights are given in Section V of the monthly editions of *Notices to Mariners*. The *List of Lights, Buoys and Fog Signals* must be consulted to determine characteristics and positions of lights, buoys and fog signals.

83 **Radio Aids to Marine Navigation** (*Atlantic, St. Lawrence, Great Lakes, Lake Winnipeg, Arctic and Pacific*) is updated each April and amended by the *Navigational Warning (NAVWARN)* service and *Notices to Mariners*, when applicable. *Radio Aids to Marine Navigation* is avail-

FIVE EASY STEPS FOR UPDATING YOUR NAUTICAL CHART

1. Check index in monthly Notices to Mariners to find which chart is affected.

Index 1	3891 East Narrows and/et West Narrows - New Chart - 08-SEP-89 - NAD83
28-FEB-2003 or 2003-02-28	
Add	port hand daybeacon
Symbol - use Chart 1 for a description	Co-ordinates
	LNM/D 24-AUG-2001 or 2001-08-24
	53°08'43.1" N 132°22'04.1" W
	(P202044P) DFO (6200076-01)

2. Plot latitude co-ordinate on chart border using dividers. Mark this distance on the chart.

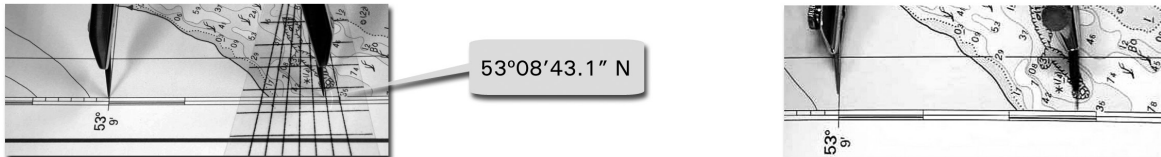

3. Plot longitude co-ordinate on chart border using dividers. Mark this distance on the chart.

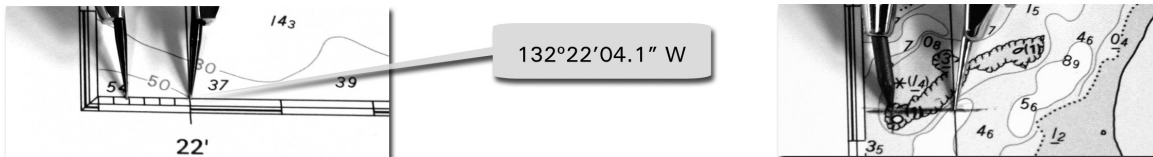

4. Use Chart 1 to help find required change. Add symbol at intersection of latitude and longitude.

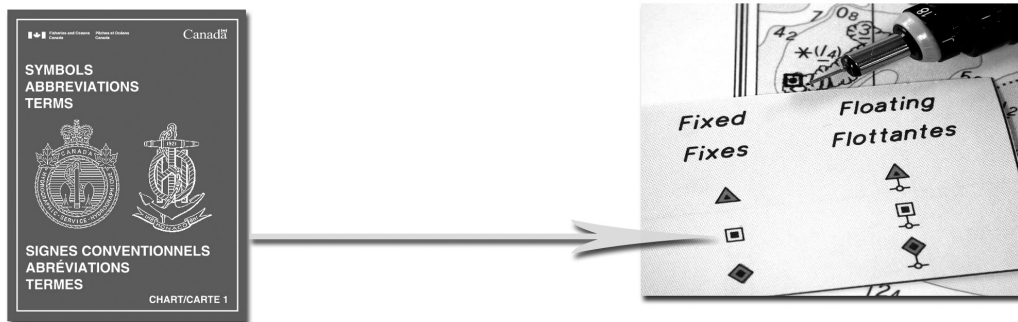

5. Apply Notice date onto chart in appropriate location.

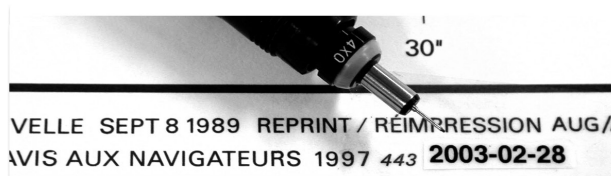

able online, free of charge, on the *Canadian Coast Guard* website. This publication provides information on radio communications, radio navigational aids services and Vessel Traffic Services provided in Canada by the Canadian Coast Guard. Also included are radio facilities of other government agencies that contribute to marine safety in Canadian waters.

84 ***Notices to Mariners 1 to 46 Annual Edition*** contains information concerning various regulations, firing practice and exercise areas, routing of ships, search and rescue and marine services provided by the Canadian Coast Guard.

85 ***Notices to Mariners Monthly Edition*** contain important navigational information including amendments to charts, *Sailing Directions*, *List of Lights*, *Buoys and Fog Signals* and *Radio Aids to Marine Navigation*. The release of new charts and the withdrawal of old ones, the availability of new editions of nautical publications and the issue of new marine regulations are announced through this publication. These notices are obtainable free of charge on request to:

Leader, Notices to Mariners
Navigation Aids
Navigation Systems Branch
Canadian Coast Guard
Fisheries and Oceans Canada
Ottawa, Ontario K1A 0E6
<http://www.notmar.gc.ca/>

86 Collectors of Customs and Excise, Base Managers of the Canadian Coast Guard and dealers for Canadian charts exhibit reference copies of *Notices to Mariners* in their offices.

87 ***Notices to Shipping*** are radio navigation warnings broadcast by Canadian Coast Guard MCTS centres. They are also available online at http://www.pacific.ccg-gcc.gc.ca/mcts-sctm/notship/index_e.htm.

88 ***The Canadian Aids to Navigation System*** contains an illustration of normal navigation and special purpose buoys and daymarks, together with a description of the shapes, colours and characteristics of buoys used in Canadian waters. This is a very useful publication for mariners not familiar with aids to navigation and how they should be used.

89 ***Recommended Code of Nautical Procedures and Practices*** is published by the Marine Safety Directorate of Transport Canada and contains information on:

- Basic principles to be observed in keeping a navigational watch;
- Recommendations on operational guidance for officers in charge of a navigational watch;
- Basic principles to be observed in keeping a watch in port;
- Recommendations on principles and operational guidance for deck officers in charge of a watch port;
- Recommendations on basic guidelines and operational guidance relating to safety radio watchkeeping for radiotelephone operators.

For more information see the Transport Canada web site at <http://www.tc.gc.ca/MarineSafety/TP/TP1018/menu.htm>. Other general information can be found at <http://www.tc.gc.ca/marine/menu.htm> and <http://www.ccg-gcc.gc.ca/>.

90 ***Safe Boating Guide*** is issued free of charge by Transport Canada. It describes and illustrates the lights required to be carried by small craft, the Canadian buoyage and beacon systems and the basic steering and sailing rules. It also contains advice and information regarding search and rescue, safety equipment and practices.

91 ***Sea Kayaking Safety Guide*** is also issued free of charge by Transport Canada. It contains important safety information for this rapidly growing sport.

Natural Conditions

Seabed

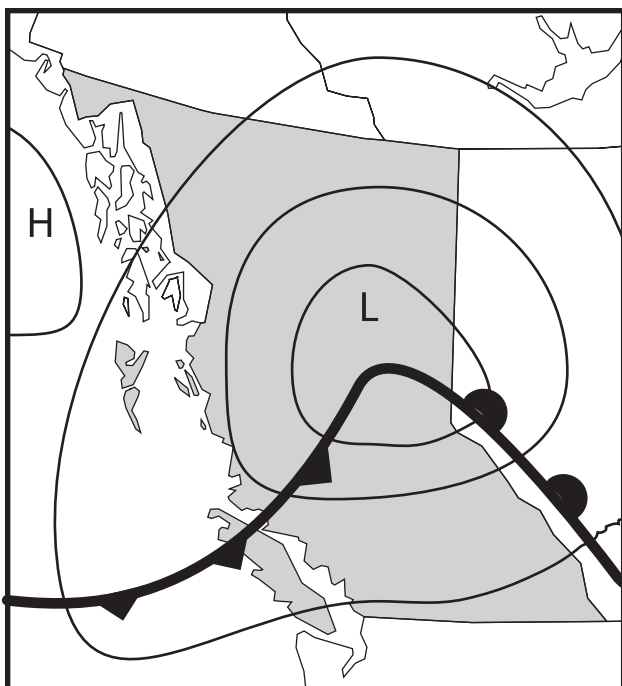

1 The continental margin west of Vancouver Island has a shelf about 40 miles wide at its south end and 10 miles wide at its north end. Between Brooks Peninsula and the head of Ououkinsh Canyon it is only four miles wide. The shelf edge and seabed lies at depths between 180 to 360 m. Several deep troughs and basins lie on the continental shelf west of Juan de Fuca Strait entrance and Barkley Sound.

2 **La Pérouse Bank** lies west and southwest of the basins and troughs fronting Barkley Sound. **Swiftsure Bank** lies in the west approach to Juan de Fuca Strait. These banks cover an extensive area and are used by commercial fishermen. Deep fjords penetrate the west coast of Vancouver Island. North of Barkley Sound, deep troughs from these fjords do not extend across the continental shelf and there are no deep basins on this portion of the shelf.

3 The continental slope along the west coast of Vancouver Island and Washington descends to depths of 1 800 to 2 500 m and is indented by several canyons. **Juan de Fuca Canyon** is the only canyon that penetrates the shelf to any great extent. The trough at the head of this canyon leads NNE, across the shelf, into Juan de Fuca Strait.

4 Canyons to the north of Juan de Fuca Canyon that indent the continental shelf are, from south to north: Nitinat Canyon, Barkley Canyon, Loudoun Canyon, Father Charles Canyon, Clayoquot Canyon, Esperanza Canyon, Kyuquot Canyon, Crowther Canyon, Ououkinsh Canyon, Quatsino Canyon, Kwakiutl Canyon, and Pisces Canyon.

5 The continental margin west of Haida Gwaii has a narrow shelf between 2 and 10 miles wide. The continental slope is tripartite, having steep upper and lower slopes with gradients about 20° . Its central part has a gentle reverse gradient often broken by ridges and sediment-filled troughs. One of the world's greatest crustal fractures, the Queen Charlotte Fault Zone, runs along this continental margin and is in large part responsible for its shape. The area is prone to earthquakes of magnitudes to 8.6 on the Richter scale.

6 **Dixon Entrance** is a deep trough separating the north end of Haida Gwaii from Dall and Prince of Wales Islands and continues east to the entrance of Portland Inlet. Learmonth Bank, in the west entrance to Dixon Entrance, is an extensive bank with an uneven bottom and a least known depth of 37 m. An ebb tidal stream with west winds can create sea conditions

that are hazardous to small craft on the bank. **Celestial Reef** and **West Devil Rock**, in the centre and near the east end of Dixon Entrance, are dangerous reefs on a common bank with a very uneven bottom.

7 The continental slope and shelf between Vancouver Island and Haida Gwaii are indented by several canyons. The shelf edge in this area lies at depths between 300 and 400 m. The two largest banks in this sound are North Bank, at 104 m depth lying to the NW, and Goose Island Bank at 31 m depth lying to the SE.

8 **Hecate Strait** is a submarine valley which narrows sharply at the north portion and whose deepest part is adjacent to the mainland shore. Depths diminish from around 300 m in the south to about 50 m in the north. Dogfish Banks, at the west side of the northern three-quarters of the strait, is a broad platform of glacial sands and gravels with depths decreasing northward from 90 m to 20 m adjoining the flat coastal plain of Graham Island.

9 **Coast Mountains**, to the east of Queen Charlotte Sound and Hecate Strait, were formed by uplift and erosion modified by more recent glaciation. A system of roughly parallel blocks, separated by lateral and transverse valleys, forms an intricate pattern of coastal channels and fjords. Glaciers moving down these valleys created steep sides and deep floors in these channels and fjords which afford a convenient inside passage along the coast.

10 **Bowie Seamount** ($53^{\circ}18'N$, $135^{\circ}40'W$), about 100 miles west of Graham Island, has a least depth of 24.3 m. The summit area, with depths less than 370 m, is 7 miles long (ENE/WSW) and about 2 miles wide (NW/SE). The most notable bathymetric feature of Bowie Seamount is a terrace at 240 m that is most prominent at the east and west ends of its ridge-like summit. A profile taken east from the summit revealed a depression near the base of the seamount with depths greater than the oceanic depths (about 2 800 m) on this side of the seamount.

11 A seamount chain extends NW from Bowie Seamount into the Gulf of Alaska. Named seamounts close to Bowie Seamount in this chain are **Hodgkins Seamount** and **Dickins Seamount**.

12 **Dellwood Seamount Chain** lies about 80 miles west of Cape Scott at the NW extremity of Vancouver Island. **Scott Seamount Chain** lies about 25 miles west of Dellwood Seamount Chain. **Paul Revere Ridge**, SE of Dellwood Seamount Chain, is separated from **Haida Ridge** to the east by **Vancouver Gap**. These two ridges lie parallel to, and on the lower part of the continental slope off the NW end of Vancouver Island. **Seminole Seamount** ($49^{\circ}45'N$, $129^{\circ}46'W$) lies about 30 miles west of the south end of Paul Revere Ridge.

13 **Cascadia Basin**, at the foot of the continental slope bordering southern Vancouver Island and Washington, is

bounded on its west side by **Juan de Fuca Ridge**. **Juan de Fuca Abyssal Plain** lies on the west side of Juan de Fuca Ridge. Several seamount chains trend NW from the ridge across the abyssal plain. Some of these seamount chains and seamounts are:

14 **Heck Seamount** ($48^{\circ}25'N$, $129^{\circ}23'W$) is the largest of the **Heck Seamount Chain**, which is 35 miles long and consists of three peaks. Other peaks are **East Peak** and **West Peak**. **Endeavour Seamount** lies 7 miles east of East Peak.

15 **Heckle Seamount Chain** lies about 15 miles SW of Heck Seamount Chain. **Heckle Seamount** ($48^{\circ}29'N$, $130^{\circ}08'W$) is the NW and largest summit of this chain.

16 **Springfield Seamount** ($48^{\circ}05'N$, $130^{\circ}12'W$) lies 24 miles SSW of Heckle Seamount.

17 **Cobb Seamount** ($46^{\circ}46'N$, $130^{\circ}48'W$) has a minimum depth of 23.8 m. The base of this seamount covers an area of 240 square miles and mean gradient of its slopes is 12° . It has four terraces and a centrally located pinnacle. The uppermost terrace, about 2 miles in diameter, lies in depths down to 90 m.

18 **Bathymetric maps** of the sea floor, portraying submarine topography, are available for the west coast of Canada. The General Bathymetric Chart of the Oceans (GEBCO) is at scale 1:10 million and the Natural Resource Maps are at 1:250 000.

19 Production of GEBCO was supervised by a joint Guiding Committee composed of members nominated by the International Hydrographic Organization (IHO) and the Intergovernmental Oceanographic Commission (IOC) of UNESCO. The Fifth Edition of GEBCO, completed in 1984, consists of 18 charts covering all oceanic areas. Sheets of the Fifth Edition of GEBCO, and its digital equivalent, the GEBCO Digital Atlas, are available through chart dealers.

20 Natural Resource Maps, published at a scale of 1:250 000, showing gravity and magnetic anomaly fields and bathymetry, are available for offshore areas of Canada, including British Columbia. Bathymetric maps of this series are designed as a seaward continuation of the National Topographic System. Natural Resource Maps are published by CHS and are available through chart dealers.

Meteorology

21 **Climate and weather conditions.** — A general description of the coast is provided below followed by information on regional inshore and offshore waters.

22 **Land.** — To a large degree physical properties of both land and ocean surfaces determine climate of the British Columbia coast. Steep mountains tower above the coast and reach elevations of several thousand metres within a few miles of most shorelines. They extend beyond provincial

boundaries and to the north and NW reach Alaska and the Aleutians. Mountains have a profound influence on cyclone tracks, winds, precipitation and visibility.

23 **Ocean.** — Temperature of ocean surface varies slightly from year to year. It also varies seasonally and with latitude. Off the north British Columbia coast the range, winter to summer, is approximately 3 to 11°C and off the south coast approximately 7 to 14°C. With such temperatures the surface does not freeze. However, some inlets along the mainland coast penetrate the continent quite deeply. In very cold winter weather a limited amount of ice can form at the heads of these inlets. During such times very small ice floes may reach estuaries of larger rivers.

24 Every few years an **El-Niño** event results in water temperatures 1 to 3°C warmer than normal for a few months. These events are triggered by wind and ocean conditions along the equatorial Pacific, where they tend to occur about Christmas time (hence the name, after El Niño, the Christ child). Accompanying most El Niño winters is a strengthening of the Aleutian Low Pressure System (described below) with stronger southerly winds along the B.C. coast that push warmer waters into British Columbia. During El Niño events fish and other marine species appear in B.C. waters that are usually seen only further south.

25 **In summer,** water temperature along the immediate coast is frequently a few degrees colder than it is a few hundred miles further offshore. This is caused by upwelling of cold water along the continental shelf during periods of steady NW wind. Such periods are common in summer and the irregular distribution of temperature that develops is the primary cause of advection fog, which restricts visibility over large areas. NW winds and upwelling in summer are stronger along the SW coast of British Columbia than in northern B.C. waters. Upwelling is strongest off Oregon and northern California.

26 **General circulation.** — Barometric pressure averaged over several decades indicates two significant features in summer and winter of the northeast Pacific. First is an anticyclone at low latitudes called the North Pacific High. The second is the Aleutian Low, a cyclone at higher latitudes. These features vary greatly in intensity, from day to day, and may be completely absent on some days. However, they exist 'on the average' and are described therefore as semi-permanent. The North Pacific High is elongated. In winter, its major axis lies along a line from North California to Hawaii. In summer the axis is almost parallel to this line but lies about ten degrees of latitude farther north.

27 The Aleutian Low at higher latitudes is also elongated. In winter the axis stretches from the north Gulf of Alaska to the Aleutians. In summer it is displaced far to the NW and lies near Kamchatka. Intensity varies throughout the year, the anticyclone being strongest in summer and the cyclone strongest in winter.

28 A branch of the general circulation, known as 'westerlies', lies between these two features. Summer westerlies are weaker than those of winter and displaced farther north. As a rule some sections of the British Columbia coast lie across westerlies throughout the year. Despite the name, flow in the westerlies is not everywhere symmetrical nor along parallels of latitude. This is the region where major migrating depressions are found together with their attendant frontal systems. Changes in circulation are both frequent and pronounced with cyclonic and anticyclonic conditions alternating at irregular intervals.

29 Amongst other factors, intensity of frontal depressions depends upon temperature difference between the air masses involved. In winter, north Canada and Alaska are vast sources of very cold air. In contrast, the ocean surface produces air masses that are relatively warm and moist. Subsequent interaction of these vastly different air streams produces cyclones of great vigour, which for a time superimpose upon westerlies their strong individual circulations.

30 During long summer days the north continent is warmed quite strongly. The effective source of cold air becomes the Arctic Ocean much farther north. Lacking frigidity of the winter continent it produces air that is cool rather than cold. During summer, fronts are weaker, attendant cyclones less frequent and less vigorous, and storms as a rule are shifted farther north.

31 In summary, atmospheric flow patterns off the British Columbia coast change greatly in both strength and direction from day to day. Basically, they are stronger in winter than in summer, and stronger when near migratory cyclones than when near anticyclones.

32 **Winds.** — Strongest winds along the exposed British Columbia coast accompany intense cyclones and fronts associated with them, usually in autumn and winter. With the most violent of these, sustained winds in excess of 65 kn have been recorded in exposed areas and it is estimated that gusts up to 100 kn occur. The pattern of winds surrounding each cyclone is anti-clockwise. However, two additional factors are important in this area. First, most frontal cyclones are at least partially occluded by the time they arrive over British Columbia coastal waters. Second, both direction and speed of wind are influenced by topography and in any locality may depart widely from the usual pattern. This is particularly so in inlets which are not aligned with general wind direction.

33 Generally, as a cyclone approaches the coast, winds back into the SE quadrant and increase in speed, often reaching gale force. As the storm centre moves inland a shift to SW, west or NW occurs but again both direction and speed are influenced to a marked degree by local terrain. For example, strong NW flow that follows a storm is unaffected by the terrain along the west coast of Vancouver Island. However, in Juan de Fuca Strait this flow is deflected to a westerly wind

and in the east part of the strait with escape of air into the Strait of Georgia, even to SW. Departures of this nature are frequent and significant along the coast.

34 Height and steepness of coastal terrain have profound effects on movement of approaching cyclones. Many vortices that have previously moved steadily toward the coast from west or SW start to move erratically and are ultimately deflected either north or south. Those that have followed the favoured track from the SW are diverted most often into the Gulf of Alaska where they gradually decay. This circumstance contributes greatly to prevailing SE winds along the coast, and low average pressure in the Gulf of Alaska especially in winter. On an annual basis, prevailing wind over the open ocean is SE (25% of the time) followed in order by NW winds (20%), west winds (12%), and SW winds (11%). However, there are marked seasonal variations in frequency of winds from particular quadrants.

35 Two features of note are pronounced excess of SE winds in the fall as the rainy season recommences, and the

Seasonal Wind Directions (%)				
	SE	SW	W	NW
Winter	26	11	10	16
Spring	24	11	13	22
Summer	19	11	16	27
Fall	34	12	8	14

excess of NW winds in summer. Since the latter promote upwelling of cold deep water along the coast, which in turn produces advection fog, poor visibility is the major weather hazard in the normally quiet summer season.

36 Winds in excess of 34 kn occur quite frequently in winter. Duration of individual storms is about one to two days while the interval between storms varies from one to five days. Under exceptionally settled circumstances, periods of up to two weeks may elapse without gales. In spring, average duration decreases to a day or less and the interval between storms increases to about one week.

37 Summer is the quietest season and intervals between gales can be as small as two weeks or as great as six. Fall sees a transition between quiet summer circulation and the vigorous winter one. Duration and frequency of gales increase and conditions do not differ too greatly from spring.

38 **Strong winds** occur without cyclonic storms. Of particular importance due to their strength and suddenness are **Squamish winds**. These occur periodically in most mainland inlets and in west coast inlets of Haida Gwaii in winter. During clear winter weather a vast pool of very cold air accumulates on the interior plateau and is contained there, for a time, by the great mass of the coastal ranges. Eventually some mechanism, usually a fall in pressure in the offshore area, triggers movement of this cold air toward the coast.

Its normal gravitation toward sea level is accentuated by the orientation and narrowness of major inlets.

39 Speeds more than 50 kn have been recorded in such outflows, and there are unverified reports of speeds greater than 75 kn. As a rule these streams of out-flowing wind spread as they reach mouths of inlets, but their effect is experienced many miles beyond the inlet mouth. For example, Victoria receives NE gales from outflow through Howe Sound and the Fraser Valley, while Cape St. James feels the effect from Douglas Channel.

40 Another feature encountered on the British Columbia coast, and particularly in inlets on the west coast of Haida Gwaii, is the **Williwaws**. These are violent squally winds, usually of short duration, experienced near mouths of narrow inlets due to seaward drainage of cold air from high ground through narrow valleys or fjords. They are primarily a winter phenomenon. **They can be dangerous to vessels at anchor because of their very sudden onset, and radical changes in direction of successive gusts may cause vessels to yaw badly, with the possibility of dragging anchor.**

41 On warm summer days, high temperature of the land contrasted with that of the sea promotes an onshore flow of air known as the 'sea breeze'. While these breezes normally pose no problems, except to very small craft in long fjords and harbours, they sometimes develop into strong winds without reaching gale force. At night, reverse temperature gradient promotes the 'land breeze', which is generally much lighter than the 'sea breeze'. **However, adjacent to high terrain, particularly in front of stream beds or small valleys, this drainage of cold air can be briefly quite violent.**

42 Tables showing wind frequency, direction and velocity for selected stations are given in the Appendices. Winds at some stations are influenced by local topography and can differ considerably from winds offshore.

43 **Precipitation.** — Total yearly precipitation is heavy along most of the coast. This is due not only to abundance of moisture in the air, but to frequency of travelling storms (producers of upward motion), and to steepness of terrain which increases this lifting many times. Although it is difficult to measure precipitation at sea it is fairly well established that only 760–960 mm fall each year in the offshore area. Along exposed sections of the coast annual precipitation in excess of 3,000 mm is common. Along the SE coast of Vancouver Island rainfall is less; annual amounts can be as small as 760 mm.

44 Temperature of the ocean prevents occurrence of persistent **snow** in the offshore area. However, in winter periodic outbreaks of cold continental air interact with milder air from the Pacific, and under such circumstances heavy snowfall does occur in coastal waters. One characteristic of such snow storms is the large size of flakes, which are can reduce visibility significantly. Snow-squalls on a more moderate scale also occur along east coasts of offshore islands

when cold air from the interior moves out toward the ocean. Although such an air stream is dry as it leaves the mainland, it picks up enough warmth and moisture from the sea surface to produce clouds and snow with only modest lifting over island terrain.

45 **Visibility** in unpolluted air over the ocean surface is normally good. At times it can be reduced by precipitation, extremely low cloud or fog. Rain does not usually affect visibility greatly and mostly occurs with brisk winds. Heavy rains occurring on steep exposed coasts reduce visibility and sometimes produce a great deal of low cloudiness reaching down almost to the surface. During infrequent snow storms, mainly November to March, visibility can be very poor. Visibility near shore can be reduced at times to 0.5 mile or less, and can complicate already difficult navigational problems that the rugged coast presents.

46 **Fog** is by far the most serious factor. The main cause of fog over the ocean is transport of relatively warm moist air over a surface cold enough to condense some of the moisture. This is called advection fog, and occurs in several ways. Temperature of the ocean surface normally decreases as one moves north. A steady transport of air from low to high latitudes for a day or so will produce advection fogs if air is fairly moist and drop in temperature significant. These conditions are met in the extensive southerly airstreams that precede well developed but slow moving cyclones.

47 The most common cause of advection fog along the British Columbia coast is transport of air from the west or NW over cold, up welling waters along the immediate coast in summer. After a few days of NW wind, sea surface temperatures in the offshore area are often several degrees warmer than those inshore. Cooling of the air stream as it moves inshore produces extensive banks of advection fog which at times extend along the outer coast from Queen Charlotte Sound to Northern California. Fog persists through day and night even with moderate winds. Strong winds do tend to lift it to a very low deck of stratus cloud with some improvement in visibility, but such winds are not very frequent in summer and visibilities at or near zero persist over wide areas for several days.

48 This type of advection fog, more commonly known as sea fog, drifts over shorelines and into inlets or passages in any light onshore breeze. During the day, heat of the land evaporates it and to a lesser extent warmth of shallow sheltered waters reduces its frequency to a considerable degree. Along the outer coast several cycles of advance and retreat may occur in a single day, with visibility fluctuating widely over periods of an hour or so. Extensive fog banks lying just offshore drift across the coastline during morning as heating of land creates an onshore sea breeze. With arrival of fog over the margin of the land, heating is arrested for a time and the breeze stops. This allows heat from the land surface to evaporate the fog

and the cycle is then repeated. **Visual navigation close to shore can be challenging under these conditions.**

49 A Frequency of Fog table is in the Appendices.

50 **Main weather hazards along the coast are strong and variable winds associated with travelling storms, periodic bitter Squamish winds of winter, and extensive banks of dense sea fog that are most persistent in the summer season.**

West Vancouver Island

51 **Water temperatures.** — Sea surface temperature ranges from about 7°C in winter to 14°C in summer. At the landward end of inlets, effect of the land mass of Vancouver Island causes water temperatures to be a few degrees lower in winter and 1° or 2°C higher in summer. From June until October the ocean surface is frequently warmer in offshore areas than along the immediate coast where upwelling of cold water occurs after periods of steady NW wind. This is the primary cause of sea fog.

52 **Air temperatures.** — Coldest months are January and February and warmest July and August. Temperatures climb quite rapidly from April to June and fall just as quickly from September to November. In winter daily range of temperature is from about 1°C to about 7°C, but in cold spells it is not unusual to have temperatures of minus 5°C and, on rare occasions minus 12°C. At the heads of long inlets the chilling effect of the land mass is felt more strongly, during cold weather temperatures are about 4°C lower than at the seaward entrance. On rare occasions they have fallen to about minus 16°C. During periods of mild winter weather temperatures reach 10°C fairly often and 15°C infrequently.

53 In summer, daily range of temperature is from about 10°C to 15°C, but it is not uncommon for temperatures to rise to 22°C during hot spells. At the heads of long inlets on such occasions, warming effect of the land mass is significant and extremes of 37°C have been recorded.

54 **Cloud cover.** — The region is much affected by travelling cyclones which approach from the sector between south and NW. They are frequent and intense in winter, relatively infrequent and weaker in summer. Skies are overcast about 70% of the time in winter and relatively clear only about 20%. Despite infrequent occurrence of disturbances in summer, extensive shallow cloudiness persists and skies are overcast about 50% of the time and relatively clear about 30%. In ports at the heads of inlets, cloudiness in winter differs little from normal, but in summer heating of the surrounding land is effective in decreasing cloudiness especially during the afternoon.

55 **Precipitation.** — Most precipitation in this region arises from interaction of travelling storms with steep moun-

tainous terrain that reaches an elevation of 2 000 m in the central part of Vancouver Island. A few hundred miles offshore annual precipitation amounts only to about 760 mm, but along the immediate coast it averages about 3 000 mm per year. In some valleys that open to the SW annual totals in excess of 5 000 mm have been recorded.

56 Most precipitation falls between October and April when travelling cyclones are most frequent and intense. During the rainy season monthly amounts of 430 mm are quite common. Maximum amount falling in any one day ranges from 150–220 mm. In the wet season the number of days on which precipitation occurs averages about 22 per month, during the dry season this decreases to about ten.

57 Snow is confined to November through March and occurs when air from the ocean overruns cold Arctic air that has moved down from the north continent. These outbreaks of cold air are most frequent in January and February. Annual snowfall averages about 40 cm along the outer coast but can exceed 130 cm at the heads of longer inlets. The number of snowy days is about ten per season along the outer coast and about fifteen at the heads of inlets.

58 **Visibility.** — For most of the year fog is distributed fairly evenly throughout day and night. Summer fogs in July and August occur more frequently in early morning and clear off in the afternoon. Months with least fog are April to June. The foggiest period is July to September. Advection fog, caused by warm moist air from the west or NW being transported over cold up-welling coastal waters, is the most common source of fog along the coast. It drifts inland in any light onshore breeze and often penetrates even the longest inlets.

59 During July to September dense smoke haze from forest fires can spread for considerable distances from shore and may impede navigation.

60 Heavier coastal rains often produce low cloud that reaches down almost to the water surface and under such circumstances visibility can be reduced to less than 0.5 mile. Winter snow storms are infrequent but during these storms visibility is poor.

61 **Winds.** — Along the outer coast winds are predominantly from SE or NW, and account for about 65% of all winds over the year. During the stormy season, October to March, SE winds are most dominant, accounting for 45% of all winds compared with about 20% for NE. In the period May to September these percentages are approximately reversed. Strongest winds accompany intense cyclones and fronts associated with them. Generally, as a cyclone approaches the coast, winds flow back into the SE quadrant and increase in speed, often reaching gale force. With passage of the storm, winds tend to shift into the NW quadrant but there can be temporary periods of SW wind. In the most intense storms

of winter, maximum sustained wind speed is about 65 kn but it is estimated that gusts up to 90 kn occur on occasion.

62 Steepness of terrain influences both speed and direction of winds to a significant degree, and in any given locality these can depart widely from the general pattern. This is generally the case in inlets not aligned with general wind direction. In winter, winds in excess of 34 kn (gales) occur quite frequently. Duration of individual storms is of the order of one day while the interval between storms varies from one to five days. However, under exceptionally settled winter conditions periods up to two weeks may elapse without gales. During spring, duration of gales decreases to less than one day for the most part and the interval between them increases to one week or more. Travelling storms in summer are infrequent and less intense than those of winter. The interval between gales can be as small as two or as great as six weeks. Autumn is a transitional season between more settled weather of summer and stormy winter weather and conditions are much like those in spring.

Juan de Fuca Strait

63 **Water temperatures.** — Juan de Fuca Strait is a long passage about 12–15 miles wide with mountainous terrain on either side. Since it connects outer waters of the Eastern Pacific Ocean with inner waters of the Strait of Georgia, climate at the west entrance resembles that of the outer coast while at the east entrance it is more like that of the Strait of Georgia. Transition between the two climates is more or less gradual and is completed over a distance of about 60 miles. Sea surface temperatures are relatively cold ranging from about 7°C in winter to 12°C at the most in summer. This factor favours the drift of sea fog east through the strait in summer.

64 **Air temperatures.** — In winter, daily temperature range is from about 1° to 7°C, but it is not unusual to have temperatures of minus 5°C and on rare occasions minus 15°C. During periods of mild weather in winter temperatures reach 10°C fairly often and infrequently 14°C. In summer the daily range of temperature is from about 10°C to about 20°C but it is not uncommon for temperatures to rise to 28°C during hot spells and extremes of 35°C have been reached on rare occasions.

65 **Cloud cover.** — In winter cloudiness is fairly uniform along the strait, skies being overcast about 70% of the time and relatively clear only about 20%. In summer the difference in cloudiness between west and east sectors of the strait is much more significant. Despite infrequent occurrence of disturbances in summer there is extensive shallow cloudiness at the west entrance but very little at the east entrance. As a consequence, at the west entrance summer skies are overcast

about 50% of the time and clear about 30%, while at the east entrance these figures are approximately reversed.

66 **Precipitation.** — Annual precipitation amounts are about 3 800 mm at the west entrance decreasing to about 615 mm at the east end of the strait. Most precipitation falls between October and April, during this period monthly amounts of 500 mm are common in the west decreasing to 100 mm in the east. Maximum amount falling in any one day is about 234 mm in the west and about 80 mm in the east. In the wet season precipitation falls on about twenty days each month, during summer the number decreases to about eight days. Snow is confined to November to March. Annual snowfall averages about 61 cm in the west and 32 cm in the east. Average number of snowy days is eleven in the west and east.

67 **Visibility.** — While snow or very heavy rain can reduce visibility to 0.6 mile or less on occasion, sea fog is by far the most frequent cause of poor visibility. It is formed when relatively moist air is transported over a cold water surface. While this situation sometimes occurs in south airstreams that precede slow moving depressions in winter, it happens much more frequently in summer when air from the west or NW is transported across the colder waters of the strait. This type of fog can persist day and night at the west end of the strait even with moderate winds and is often carried to the east end by west breezes that develop due to the heating of the land mass in periods of settled summer weather. Under these circumstances it has been noted that fog banks penetrate the south side of the strait more readily than the north side, reaching Port Townsend more frequently than Victoria.

68 On average visibility is reduced to less than 0.6 mile on about 55 days per year at the west end of the strait, on about 35 days per year at the east end. Seventy percent of fog at the west end occurs during the period mid June to mid October. At the east end the fog season lasts a little longer and only 45% of all fogs occur in summer and early autumn.

69 **Winds.** — Mountainous terrain on either side of the strait does not permit development of SE or NW winds that are so common in the Strait of Georgia and along the west coast of Vancouver Island. Instead flow in the central part of the strait is either east or west. At the west entrance the wind regime is much like that of the west coast but at the east entrance, particularly on the Canadian side, circulation differs significantly from that of the Strait of Georgia.

70 In winter as disturbances move toward the coast strong, east winds develop in the central part of the strait. This circulation in turn promotes drainage of air from the Strait of Georgia and from October to March nearly 40% of all winds at Victoria are from the sector north to NE. After storms move inland winds usually shift to west, but near Victoria, movement of air toward the Strait of Georgia greatly increases frequency of winds blowing from the sector SW to west.

Gales are quite frequent from October to March occurring on about fifteen days per month on average at the west entrance and on about ten days per month in the east part of the strait. Sustained speeds in excess of 50 kn have been recorded with gusts reaching 80 kn.

71 Frequency of gales decreases in the warmer season and by mid summer on average only one or two gales occur each month. However during this period heating of the west continent promotes a large-scale inflow from the ocean toward the mainland coast. Frequency of west and SW winds rises from a winter average of 20%, to a summer maximum of 60%, but they seldom reach gale force unless for other reasons.

Strait of Georgia

72 **Water temperatures** in the Strait of Georgia can be divided into two layers, the surface layer shallower than about 50 m and the lower layer below this level to maximum depths. Observed temperatures in the lower layer are nearly uniform throughout the year, at 8° to 10°C, with winter values about 1°C higher than summer values.

73 In winter in most parts of the strait temperature of sea surface is about 7°C, but during cold spells it is often a few degrees lower near the heads of major mainland inlets and at mouths of large rivers along the mainland coast. In very severe winters ice forms at the heads of the longest inlets and small ice floes come down major rivers but not to a degree that impedes shipping. In summer water temperatures rise to about 15°C and in shallower parts of the strait to 17°C. In May and June, the time of freshet in rivers, sea surface temperatures in estuaries are often 2°C to 3°C lower than in adjacent parts of the strait.

74 **Air temperatures.** — In winter, air temperatures in the Strait of Georgia are a little lower than on the west coast of Vancouver Island and in summer noticeably higher. January and February are still the coldest months, July and August the warmest. Temperatures rise rapidly in April and May and fall just as quickly in September and October. In midwinter daily range of temperature is from about 0°C to 5°C but during cold spells it is not unusual to have temperatures of minus 8°C and on extremely rare occasions temperatures of minus 18°C have been recorded. During periods of mild winter weather temperatures reach 10°C fairly often and on rare occasions 15°C. In summer daily range of temperature is from about 12° to 22°C but during warm spells it is not uncommon to have temperatures of 29°C. On rare occasions temperatures of 34°C have been recorded.

75 **Cloud cover.** — In winter, skies are overcast about 70% of the time and relatively clear only about 15%. In summer skies are overcast only about 35% of the time and relatively clear about 40%. There is a tendency for more sunshine

along the west shore of the strait than along the mainland shore but except in the immediate vicinity of Victoria, which is one of the sunniest places in British Columbia, this is not pronounced.

76 **Precipitation.** — Since much of the moisture from Pacific storms is dropped on the mountains west and SW of the region, annual precipitation in the Strait of Georgia is much less than along the west coast of Vancouver Island. Normal amount is about 1 000 mm per annum but since topography has such an important influence some places receive as little as 700 mm others more than 2 100 mm per year. The extreme southeast coast of Vancouver Island, lying in the rain shadow of the Olympic Mountains, is the driest region and steep mountainous slopes of the mainland coast are wettest.

77 Most precipitation falls between November and March and during this period it is common to have 20 wet days per month producing an average monthly amount of about 150 mm. However, in prolonged wet spells monthly amounts more than 310 mm have been recorded, with maximum daily rainfall ranging between 60 and 120 mm. In summer on average there are about five rainy days per month on which 30 to 50 mm of rain accumulate.

78 In winter cold Arctic air occasionally bursts down mainland inlets and across the Strait of Georgia moving out to the ocean through Juan de Fuca Strait. These outbreaks produce snow either by forcing subsequent disturbances from the Pacific to go aloft or by evaporating water from the surface of the strait and depositing it later as snow. In the first case snowfall is quite general, but in the second case it is usually confined to the east coast of Vancouver Island. Snow can fall any time from November to March but it is most frequent from mid December to mid February. On average there are about 10 snowy days each season, with total snowfall amounting to between 31 and 61 cm.

79 **Visibility.** — Chief restrictions to visibility are fog, certain forms of precipitation and smoke. Most fog occurs from September to March and is caused by moist air cooling over land surfaces during long winter nights. It is usually dissipated by daytime heating but in prolonged periods of clear weather in the colder season fog can persist throughout the day. Visibility falls below 0.6 mile on about 20 days per year in most coastal areas but this figure can be as high as 60 days in preferred places such as the flat land in the delta of the Fraser River where, at certain times, relatively low temperature of river water contributes to the cooling process.

80 Only heaviest rains affect visibility to any marked degree but in coastal snow storms visibility is usually less than 0.6 mile. During periods of settled weather in late summer and autumn smoke from forest fires or from large urban areas tends to accumulate in the strait and when extensive can impede navigation to some degree.

81 **Winds.** — In the open strait winds are predominantly either from SE or NW but along the mainland coast the SE winds are replaced by those from the east. During the stormy winter season east or SE winds occur more than 60% of the time, west or NW winds about 10%. In summer percentages are closer to 20 and 50 respectively. In the area adjacent to the east entrance of Juan de Fuca Strait, SW winds occur about 20% of the time mainly after the passage of disturbances in winter but occasionally in summer as well.

82 Direction and speed of wind are much influenced by terrain and in any given locality can depart widely from the general pattern. Although the strait is protected by the mountains of Vancouver Island gales do accompany the more intense storms of winter, blowing from the SE as the system approaches and veering to the west or NW after its passage. Winds in excess of 34 kn occur on the average 3 or 4 times per month during the period October to March. In exposed areas sustained wind speeds of about 50 kn have been recorded on rare occasions with peak gusts estimated at 70 kn.

83 Strong winds occur without cyclonic storms. Of particular importance because of their strength and suddenness are **Squamish winds** that occur periodically in most mainland inlets in winter. During clear winter weather a vast pool of very cold air accumulates on the interior plateau of British Columbia. Sometimes a fall in pressure in the offshore area causes it to move toward the coast. Normal gravitation toward sea level is accentuated by the orientation and narrowness of major inlets and speeds more than 50 kn have been recorded in some of these outflows. These streams of outflowing wind spread out as they reach the mouths of inlets and only rarely do they remain strong 15 or 20 miles away. Howe Sound, Jervis, Toba and Bute Inlets all experience these winds to some degree each winter.

84 **Small craft crossing from the Gulf Islands to Lower Mainland will find the following information on summer winds useful.** During summer months of June to September, normal prevailing wind in the Strait of Georgia is NW, also referred to as a Westerly wind. This is “good weather wind” as the occasional SE wind that blows during summer is almost certain to bring rain and clouds to the area.

85 For small craft crossing the Strait of Georgia the most frequently used routes are Nanaimo to Welcome Passage and Silva Bay to Burrard Inlet. The prevailing Westerly wind pattern, in summer, in the Strait of Georgia, is quite the opposite to the wind pattern found in Juan de Fuca Strait. While the most favoured time for crossing Juan de Fuca Strait is in the early morning, for the Strait of Georgia a late afternoon or early evening crossing is preferred.

86 It is often true that the Strait of Georgia will be calm and smooth at daybreak. However, if the normal Westerly develops, the wind will not be too long in coming and mariners who start off early in the morning in calm weather may be

confronted with rough conditions by the time they reach the middle of the Strait of Georgia or complete the crossing.

87 The following general rule observed and developed over years can be followed with expectation of a satisfactory crossing in almost all cases. When the Westerly wind shows signs of letting up in the late afternoon or early evening it will almost certainly continue to drop until dark, as it is very unusual for the Westerly wind to increase in velocity between late afternoon or early evening and dark. Mariners setting out on a crossing at 1700 or 1800 hours can readily determine what the water conditions are likely to be during the entire crossing. If small craft operators are satisfied with conditions when starting out they can usually count on either conditions improving or at least remaining as they are until dark. After dark, it is possible the wind may pick up again.

88 The normal Westerly wind usually goes down in late afternoon or evening but periodically there will be what is called a “Three-day Westerly” which gives the strait almost continuous fresh and gusty winds, night and day, extending over a total of three, or rarely four days. This condition (which may only happen two or three times a season) is fairly easy to determine as winds in late afternoon remain fresh and gusty and show no sign of a let-up. When they do begin to drop off in late afternoon, rough water conditions in the strait will moderate quite rapidly and a crossing should be considered that evening under favourable conditions. Quite frequently small craft skippers will make the mistake of waiting until the next morning, after having waited a day or two for the wind to drop, and then see it drop off in the late afternoon, instead of making their crossing that evening when their chances of a good crossing would be much better.

89 Comments made so far refer to the normal “good weather” Westerly of summer. When a “Southeaster” is blowing there is no discernible pattern to it nor is there a preferred crossing time.

90 One other very reliable weather sign is presence or absence of dew on decks in the evening. If decks are found wet or damp with dew it is almost a sure sign the following day will be bright and clear, whereas absence of dew may indicate a change in weather. If a wind is blowing in the evening dew will not have a chance to form and absence of dew could be misleading under those circumstances.

Johnstone Strait Region

91 **Water temperatures.** — The Johnstone Strait area is characterised by rapid tidal streams, constricted passages, and numerous shallow sills. Water is almost always in constant agitation and surface temperatures during the summer months seldom surpass 10°C. Warm air temperatures combined with these cold surface water temperatures result in fog during

summer. In winter and spring months, water temperatures are uniform in the water column and average about 7°C.

92 **Visibility.** — During late summer and early fall fog banks tend to form at the north end of Vancouver Island into Queen Charlotte Strait and usually not further than Robson Bight. Fog patches may persist in the centre of the strait during the day but generally fog goes through a cycle of accumulating during the night and dissipating by late morning. At times it can take up to noon or early afternoon to clear. Winds generally increase as fog lifts.

93 During summer there is a sea breeze effect in Johnstone and Queen Charlotte Straits. Air rising over the heated mainland coast draws cooler marine air inland resulting in westerly winds. These winds build in strength beginning in late morning and, combined with prevailing wind flow, can lead to wind speeds of 30 kn by late afternoon. The western portion of Johnstone Strait appears to be especially susceptible to these winds. The sea breeze dies out just before dusk and is replaced by a considerably weaker land breeze from the east, affecting the more open waters of Queen Charlotte Strait.

94 **Winds.** — Prevailing winds for Johnstone Strait and Queen Charlotte Strait are westerly in summer and easterly in winter. These are funnelled into northerly and southerly prevailing winds respectively, in Discovery Passage. Polar outbreaks from the mainland interior moving down larger fiords such as Knight Inlet, Kingcome Inlet, and Loughborough Inlet can lead to gale force winds over limited areas within the region. In general, strong winds along main channels are associated with passage of frontal systems.

Northern Shelf Region

95 This region includes Queen Charlotte Sound, Hecate Strait, and Dixon Entrance.

96 **Water temperatures.** — Temperature varies throughout the year and is dependant upon solar energy, sea currents and freshwater runoff. Average sea surface temperatures range from about 6°C in April to around 14°C in August. Waters of Dixon Entrance are generally colder than those of Hecate Strait and Queen Charlotte Sound. Maximum sea-surface temperatures in coastal seaway do not occur at the end of the heating season in mid-August, nor minimum cooling temperatures at the end of March, because wind-driven currents bring in relatively cold water in summer and relatively warm water in winter to partially counteract the effect of solar heating.

97 There is also a reverse seasonal variation in deep waters of the seaway, which is colder and more saline in summer than in winter. Two processes account for these reversals in trend. First, NW winds along the outer coast in summer move

surface waters seaward and thereby cause deeper oceanic water to move onto the continental shelf. Second, increased outflow of brackish water from the seaway in summer strengthens the deep inward flow of estuarine circulation. The influence of freshwater discharge is most strongly felt in Dixon Entrance in late spring and summer when runoff from the Nass and Skeena Rivers tend to flow seaward within a comparatively warm brackish layer 10 m thick that spans the northern side of the channel. In contrast, cooler, saltier oceanic water generally prevails over the southern half of the channel at this time.

98 **Air temperatures.** — Over an entire year temperatures in this region will range from about 3°C to 16°C. In summer months, June to September, average air temperatures are 11°C to 16°C. In winter months, December to March, temperatures range from 3°C to 8°C. In spring and fall expect temperatures to be between 4°C and 12°C, and 4°C to 13°C degrees respectively.

99 **Visibility.** — Percentage occurrence of sea fog over the coastal seaway is greater during summer (June through September) than during fall or winter (October through March). Fog tends to be more prevalent over the seaward approaches to Queen Charlotte Sound and Dixon Entrance than over the mainland side or over Hecate Strait. Less intense upwelling in these regions results in lower amounts of summer fogs common in the exposed coast to the south.

100 **Foggiest months** are August and September at 10-15% of the time. Fog occurs less than 5% of the time in March and April, and around 10% during May through July. Winds that sometimes accompany fog in summer may lift the moisture to a very low deck of stratus clouds with slight improvement in visibility, but in general, many days of near zero visibility are likely to persist over wide areas of the seaway.

101 **Winds.** — Prevailing winds over this inland waterway are associated with the same pressure systems that influence deep-sea wind regimes, in particular the Aleutian Low (winter), and the North Pacific High (summer). Local conditions have an additional effect on wind patterns in this area and a number of generalizations can be made. First, winds travelling over the seaway tend to move parallel to the coastline because of the bordering mountains. Second, mainland shore wind speeds drop, likely due to winds dispersing as they travel towards the coast. Finally, frequency and intensity of south easterlies is greater over the northern sector of the seaway than over the southern sector, whereas the frequency and intensity of northwesterlies is greater in the south than in the north.

102 The most pleasant months to cruise the coastal seaway are June, July and August. Prevailing winds are from the west in Dixon entrance and from the NW in Queen Charlotte Sound. Conditions usually remain favourable until early

September, but by October deteriorate rapidly with the onset of storm activity.

Deep Sea Region

103 The Deep Sea Region includes exposed waters seaward of the British Columbia-Washington coast. Current weather conditions and historical climate data collected by offshore buoys can be obtained from the National Oceanic and Atmospheric Administration (NOAA) web site at <http://www.ndB.C.noaa.gov/Maps/Northwest.shtml>.

104 **Water temperatures.** — From November to March average sea-surface temperatures range from about 10°C off Washington to 7°C just north of Haida Gwaii. By midsummer surface water temperatures outside of the upwelling zone are about 15°-16°C off Washington and 12°-14°C off British Columbia. Temperatures decrease significantly with depth, and below 150-200 m are generally colder than 5°C near mid-ocean and 7°C near the continental shelf.

105 **Air temperatures.** — Air temperatures tend to be within a few degrees of water temperatures though wind chill will push these numbers down. Exposed regions generally have temperatures ranging from 5°C in January to about 15°C in August.

106 **Cloud cover.** — North of about latitude 40°N average cloud cover per month always exceeds 75%. Maximum cloud coverage stretches in a broad east-west band seaward of the B.C. coast. Coastal cloud cover tends to be slightly lower than deep-sea cloud cover at a given latitude. Off the B.C.-Washington coast, low cloud cover increases from a midwinter value of 65% to a maximum of over 70% in July.

107 **Visibility.** — Maximum fog occurs in August with an average of 15 days in contrast to a few days a month from November through May. The foggy period lasts from June to October and corresponds to the time of prevailing winds.

108 **Winds.** — Two major large-scale pressure cells, the Aleutian Low and Pacific High, determine prevailing winds in the northeast sector of the Pacific Ocean. The Aleutian Low builds in intensity from August to January and tapers off until July. In contrast, the Pacific High reaches maximum intensity between June and August.

Water Density

109 **Sea temperature, salinity and density.** — Distribution of sea surface temperature, salinity and density is affected by broad east-setting surface currents. In the Inside Passage, this distribution is also influenced by seasonal variations in winds, tides and river outflow. Surface temperatures that are affected by the warm oceanic currents are relatively high.

Monthly Densities

Place		Jan	Feb	Mar	Apr	May	Jun	Jul	Aug	Sep	Oct	Nov	Dec
New Westminster 49°12'N, 122°55'W See Note 1	Mean Max	1.00000	1.00000	1.00000	0.99998	0.99992	0.99966	0.99933	0.99903	0.99937	0.99986	1.00000	1.00000
	Mean	0.99998	0.99998	0.99999	0.99995	0.99979	0.99950	0.99904	0.99882	0.99905	0.99966	0.99995	0.99999
	Mean Min	0.99993	0.99993	0.99998	0.99989	0.99963	0.99932	0.99883	0.99876	0.99880	0.99950	0.99985	0.99998
Vancouver Hbr 49°17'N, 123°07'W See Note 2	Max Obs		1.02185	1.02123	1.02194			1.01681	1.01817	1.01950	1.02053		1.02175
	Mean		1.02069	1.02027	1.02102			1.01587	1.01761	1.01899	1.02013		1.02145
	Min Obs		1.01703	1.01945	1.02006			1.01406	1.01647	1.01855	1.01914		1.02124
Departure Bay 49°12'N, 123°57'W See Note 3	Mean	1.01918	1.01891	1.01995	1.02020	1.01916	1.01726	1.01635	1.01784	1.01910	1.02024	1.01966	1.01957
Esquimalt/Victoria Hbr Approaches See Note 4	Max Obs			1.02419	1.02482	1.02492	1.02395	1.02371	1.02365	1.02408	1.02469	1.02437	
	Mean			1.02414	1.02453	1.02440	1.02388	1.02355	1.02356	1.02397	1.02427	1.02422	
	Min Obs			1.02413	1.02445	1.02407	1.02372	1.02345	1.02341	1.02393	1.02399	1.02400	
Kains Island 50°26'N, 128°02'W See Note 3	Mean	1.02249	1.02262	1.02298	1.02282	1.02330	1.02365	1.02351	1.02373	1.02341	1.02326	1.02264	1.02239
Port Alberni 49°14'N, 124°49'W See Note 5	Max Obs				1.00889	0.00680	1.00697	1.01322	1.01868	1.01801			
	Mean				1.00682	1.00396	1.00430	1.00951	1.01511	1.01339			
	Min Obs				1.00485	1.00076	1.00191	1.00458	1.01194	1.00681			
Prince Rupert 54°19'N, 130°20'W See Note 6	Mean Max	1.0237	1.0239	1.0238	1.0233	1.0226	1.0203	1.0203	1.0216	1.0226	1.0228	1.0232	1.0234
	Mean	1.0228	1.0230	1.0228	1.0219	1.0196	1.0180	1.0186	1.0200	1.0207	1.0205	1.0215	1.0220
	Mean Min	1.0215	1.0214	1.0201	1.0160	0.0166	1.0153	1.0162	1.0176	1.0150	1.0166	1.0186	1.0145

1. Data from 1948 - 1957. Observations made at a depth of 3 feet during the hour before the daytime high tide.

2. Data for 1950. Values are mean density from surface to about 15 feet. Values for Aug - Oct based on less than 9 observations.

3. Data from 1996-2005. Values are mean density at depth of 1 metre.

4. Data for parts of 1951 & 1952. Values are mean density from surface to about 20 feet. Values for Mar, Jun, Aug, and Sept based on less than 9 observations.

5. Data from 1939 & 1941. Values are mean density from surface to about 15 feet.

6. Data from January 1940 - June 1942. Observations made at a depth of 3 feet during the hour before daytime high tide.

Salinities vary in different sections of the coast mainly as a result of tidal currents and the presence or absence of fresh water runoff from main rivers. Distribution of density generally parallels that of salinity and varies inversely with temperature. It attains a maximum in winter when the temperature is coldest and a minimum in summer when it is warmest.

110 Density is the specific gravity of the sea water or the ratio between the weight of a sea water sample and the weight of an equal volume of distilled water at 4°C. The table of Monthly Densities shows monthly mean maximum, mean and mean minimum surface density values for selected places along the coast of British Columbia. For all harbours except Vancouver, Esquimalt, and Port Alberni density was computed from a sea water sample taken daily within one hour of the daytime HW at a depth of 0.8 m. For Vancouver, Esquimalt, and Port Alberni density was computed from serial oceanographic station data collected at different phases of the tide.

111 Although data are not available for Comox or Powell River, the density distribution for these harbours should be very much like that presented for Departure Bay.

112 Density data are presented for Kains Island (Quatsino Sound), in lieu of data for Port Alice. Densities at Port Alice most probably are considerably lower than those shown for Kains Island.

113 In northern British Columbia the greatest annual range of density occurs in the vicinity of Ivory Island due to heavy precipitation and Triple Islands because of the proximity of large rivers. Range of density at other stations is small.

114 Mean monthly sea surface densities for various ports and harbours in this area are influenced by precipitation and river runoff. Runoff is governed by ice and snow melt. Wide density variations occur in estuaries as a result of the encounter between dense oceanic water and considerably lighter river water. Densities at most ports and harbours are lowest in summer as a result of increased volume of fresh water outflow from land caused by ice and snow melt from higher elevations.

115 In the Fraser River a salt water wedge penetrates about 18 miles upstream. This salt water intrusion is described with the general description of the Fraser River.

Ice

116 Loose pieces of ice tend to come down the Fraser River but do not cause damage to shipping. Ice generally forms within inlets on the mainland north of Cape Caution (51°10'N), and reaches a thickness of 20 to 30 cm. It occasionally extends

as far as 25 miles from the heads of inlets but seldom forms in main channels.

117 **Skeena River** freezes in its upper portion during average winters and as far as Port Essington in severe years. In severe winters ice sometimes extends from Port Essington to Kennedy Island and Inverness Passage. Nass River also freezes over.

118 **Superstructure icing** can occur when air temperatures are minus 2°C or less with moderate to strong winds. The probability of these conditions occurring in British Columbia waters is estimated to be less than 5%.

119 During well-established Arctic outbreaks strong outflow winds blow out of most coastal inlets. These cold, strong winds are confined to relatively narrow jets as they leave inlets. A ship travelling along the coast can experience heavy ice accumulations on its windward side while crossing these regions of strong winds.

Tide and Current Information

 120 **Tide and current information** is based on data obtained by CHS and the State of the Ocean Section of the Institute of Ocean Sciences.

121 *Canadian Tide and Current Tables* give tidal predictions for major ports in each tidal region, tidal differences for virtually all other localities, and slack water and maximum velocity tables for the more important passes and narrows. They are published annually by CHS and can be obtained from authorized chart dealers.

122 Tidal Stream Information diagrams show locations of reference and secondary current stations in *Canadian Tide and Current Tables, Volumes 5, 6 and 7*. Additional current information not included in *Tide and Current Tables* is also shown.

Tides

123 On the British Columbia coast observed tide is the resultant of the semi-diurnal tide, with an interval between successive high waters of about half a day, and the diurnal tide with an interval between successive high waters of about one day. Consequently there may be a significant difference in height of successive high or low waters i.e. there is a marked diurnal inequality.

124 **From the entrance of Juan de Fuca Strait** the tide travels either through the strait and the Gulf Islands into the Strait of Georgia or north along the west coast of Vancouver Island to Cape Scott and then south through Queen Charlotte and Johnstone Straits and through Discovery Passage meeting the tide that has come through Juan de Fuca Strait in the

vicinity of Cape Mudge, south of Campbell River. Since the time difference of HW or LW between Juan de Fuca entrance and Strait of Georgia is almost six hours, the tide is low in the Strait of Georgia when it is high at Juan de Fuca entrance, and vice versa.

125 **On the west coast of Vancouver Island** tidal characteristics are mixed semi-diurnal with a large tide range of about 4.3 m becoming almost diurnal at Victoria, with the range decreasing to about 3 m and reverting to mixed semi-diurnal again in the Strait of Georgia. Range in the Strait of Georgia is about 5 m.

126 **In Queen Charlotte Strait** tide is mixed semi-diurnal, but with a less apparent diurnal inequality and with a range of about 5.5 m. It decreases in range again as it reaches Campbell River to about 4.6 m and shows greater diurnal characteristics.

127 The tide relative to its arrival at Queen Charlotte Sound reaches the west end of Dixon Entrance about 50 minutes later. It propagates north along the mainland coast and up Hecate Strait and north up the west coast of Haida Gwaii and east through Dixon Entrance, the two branches meeting near the north end of Hecate Strait about one hour after its arrival in Queen Charlotte Sound.

128 **Amplitudes** of semi-diurnal and diurnal components increase slightly as the tide travels north along the Pacific coasts of Vancouver Island and Haida Gwaii. In Hecate Strait and Dixon Entrance there is a large increase in the semi-diurnal component without a corresponding increase in the diurnal component. Consequently in these areas and in the inlets on the northern mainland, the tide exhibits a more semi-diurnal character than on the open British Columbia coast. Range of large tides varies from 8.1 m at Stewart to 1.6 m in Masset Inlet.

129 In long, deep inlets HW or LW occur only a few minutes later at the head than at the entrance to inlets, in some cases they occur almost simultaneously.

Surface Currents

 130 **Surface currents** are produced by many different processes. Periodic motions produced by astronomical tides are called **tidal currents or tidal streams**. Motions produced by all other processes are called **non-tidal currents**. Included in the latter category are large scale current systems generated by prevailing winds over the ocean. Tidal currents are nearly repeated every 12 hours and 25 minutes and are rotary in the open ocean and usually rectilinear in passages. Non-tidal currents are relatively constant in speed and direction for periods of weeks to months. Although both are generally weak in the open ocean, non-tidal motions usually

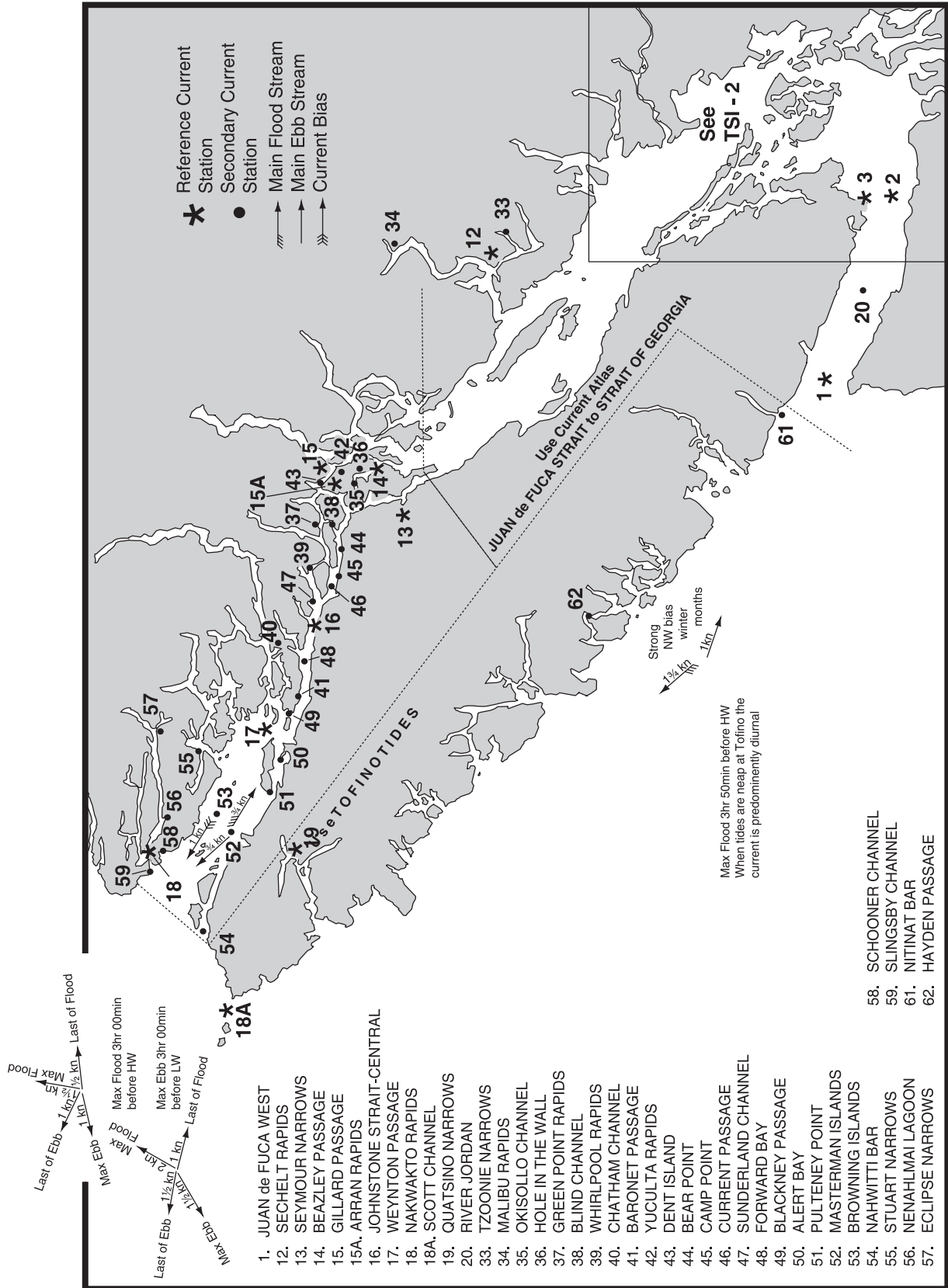

TSI - 1

TIDAL STREAM INFORMATION



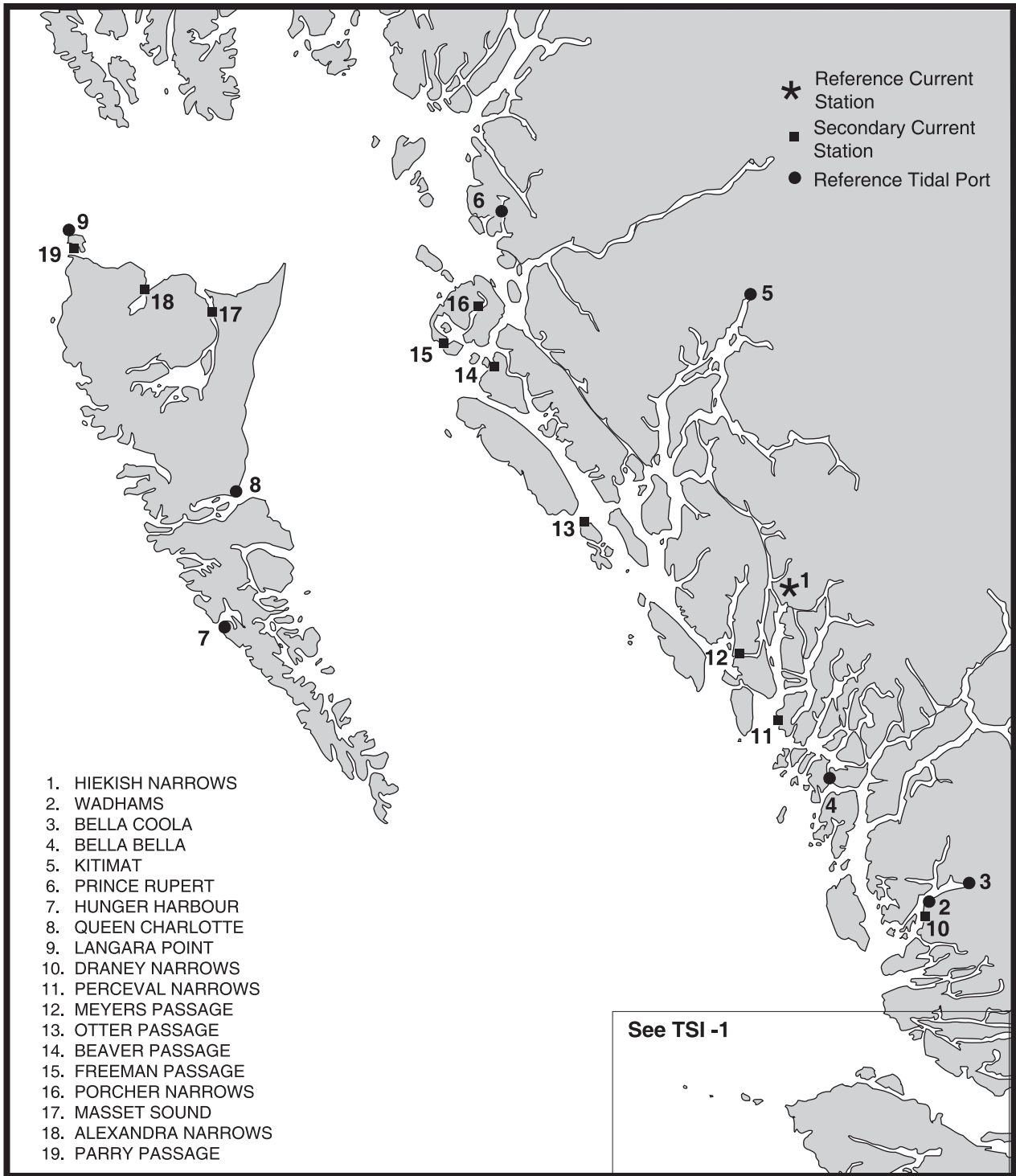

TIDAL STREAM INFORMATION

TSI - 3

predominate. Over shoaling regions of the continental shelf tidal currents often become of greater importance.

Tidal Currents

131 **Tidal currents offshore.** — The prevailing non-tidal component of currents offshore is augmented to some degree by tidal currents. In the open ocean such currents are observed to be rotary whereby tidal motions at any particular locality are constantly changing direction with time. This rotation of the direction vector can be either clockwise or counter-clockwise depending upon location and type of tide, and is repeated nearly every 12 hours and 25 minutes ($\frac{1}{2}$ lunar day). One exception is found off SW Vancouver Island, where this period is 24 hours.

132 **Speed of tidal current** also changes in a periodic manner but rarely exceeds 0.1 kn away from the coast. Only over the continental slope and continental shelf where they are amplified by shallowing depth do they become significant. In shallow depths around Scott Islands and off the north coast of Vancouver Island, tidal currents are stronger than non-tidal flow. They set in generally NW and SE directions at 2 to 3 kn.

133 Tidal streams flood and ebb into and out of sounds, straits and inlets. The flood entering Juan de Fuca Strait continues around the SE end of Vancouver Island, through passages between the Gulf and San Juan Islands, then into the Strait of Georgia and numerous inlets extending from it. Along the west coast of Vancouver Island, the flood accentuates the prevailing NW current in winter but reduces the SE current in summer. Upon entering Queen Charlotte Strait around the north end of Vancouver Island, the flood then turns SE through channels between the island and mainland, meeting the flood that has progressed northward from Juan de Fuca Strait in a region between 7 to 10 miles SE of Cape Mudge. Consequently this region is characterized by weak and confused tidal currents.

134 **The ebb current along the north side of Juan de Fuca Strait** flows parallel to the Vancouver Island coast where it can augment the NW non-tidal current in winter. The tidal stream ebbs regularly through Scott Channel and SW around the outermost of the Scott Islands. In passages between Vancouver Island and the mainland direction of the ebb streams is generally the reverse of the flood streams.

135 **The flood entering Dixon Entrance** along the north shore of Haida Gwaii splits. Part heads north into the Alaskan channels and Portland Canal, and part turns south into Hecate Strait and the inlets and channels south of Prince Rupert. Similarly the flood stream entering Queen Charlotte Sound enters channels and inlets along the coast, and part turns north into Hecate Strait meeting the flood from Dixon

Entrance at about the latitude of Skidegate. Highest tides in British Columbia are found near Skidegate, and at Steward in Portland Canal. In long channels with a north and south entrance (Grenville, Principe, Laredo and Princess Royal Channels), the flood enters from both ends and meets in the middle where tidal currents are usually weak and variable.

136 The ebb current flows out of the inlets and channels, and in the main flows in the exact opposite direction of the flood streams.

137 **In channels of the Inside Passage** tidal streams follow the general direction of the fairway branching into or coming from many connecting passages and adjacent inlets. Rates of these streams vary greatly and range up to a maximum in Seymour Narrows where the flood and ebb streams can attain 16 and 14 kn, respectively.

138 Mariners should be aware that in connecting channels in which tidal currents attain only moderate speeds, resultant currents produced by both tidal and non-tidal motions are often unpredictable. This is a consequence of complicated effects of winds, atmospheric pressure, bottom topography and irregular shapes of channels.

139 **Slack water** is the condition, usually for a short time, during which there is little or no current as the tidal streams turn from flood to ebb and ebb to flood. It should be remembered that in channels and passes slack water rarely occurs simultaneously with the time of HW and LW by the shore. The difference may be considerable and relation ir-

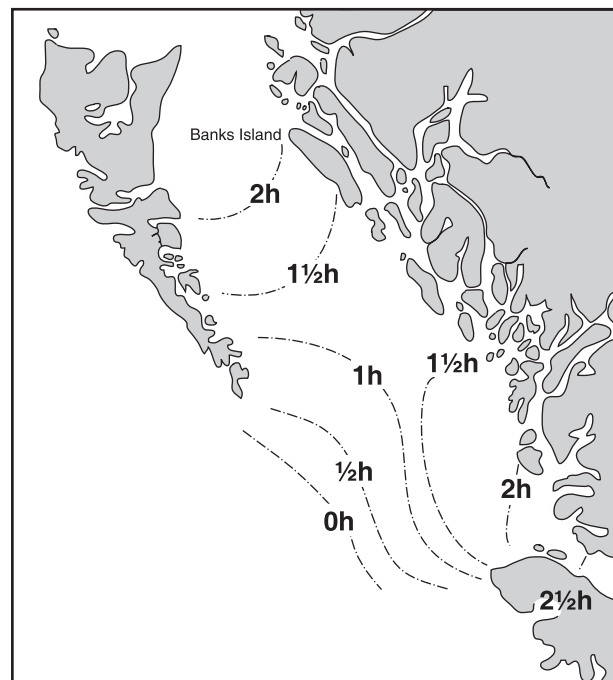

STAGES OF TIDAL STREAMS

regular. Nevertheless, the slack water nearest the time of HW is termed HW slack, and the one nearest the time of LW the LW slack. The former occurs after the run of the flood stream, and the latter after the end of the ebb stream. Tables giving times of slack water in more important passes with constants referring to others are included in *Canadian Tide and Current Tables*.

140 In inlets rates of tidal streams decrease toward the head, and the turn occurs about the time of HW and LW by the shore, or shortly afterward. When crossing the entrance of an inlet allowance must be made for tidal streams setting into or out of the inlet according to the state of tide.

141 Where sufficient data is available specific tidal information is included with the description of the various areas and places in geographic books of *Sailing Directions*. See also *Canadian Tide and Current Tables*.

 142 **Caution.** — **Tidal currents in British Columbia are the world's fastest, and caution is required in channels connecting coastal basins. Always consult the *Canadian Tide and Current Tables*.**

143 The turn of the tidal stream offshore is seldom coincident with the time of HW and LW by the shore. Off the open coast, the tidal stream may turn two or three hours after occurrences of HW or LW and in consequence, the terms “flood” and “ebb” are generally replaced by “in-going stream” or “north-going stream”.

144 **Rapids and narrows.** — In narrow channels with strong tidal streams the only safe rule is to pass through the narrows at slack water. If passage must be made through at other stages of the tidal stream the rule is to stay in smooth water, which is generally in the centre of the channel, and avoid areas of broken water, upwelling and whirlpools.

145 Powerboat wakes, when combined with strong tidal streams, often result in unnaturally high seas that could prove more dangerous than the actual rapids themselves.

 146 **Caution.** — **Current arrows on charts show the usual or mean direction of a tidal stream. It must never be assumed that direction of the stream will not vary from that indicated. Velocities given on charts are for large tides and may vary periodically.**

147 When times of turn to ebb and turn to flood are given in *Canadian Tide and Currents Tables*, on charts or in *Sailing Directions* it must never be assumed that times will not vary from those given. Apart from in Juan de Fuca Strait and the Strait of Georgia, where modern long term data is available, many of these predictions are based on sparse observations. Atmospheric conditions can cause large variations in predicted times of turn.

Non-tidal Currents

 148 Two major east-flowing non-tidal currents that cross the North Pacific Ocean north of the tropics are the **North Pacific Current** and the **Sub Arctic Current**. Both have origins in current regimes off the east coast of Asia. The largest in this regime is the strong well-defined Kuroshio that flows northward from the western Equatorial Pacific along the east coast of Japan. The smaller current in this region is the equally well defined Oyashio that sets SW along the Kuril Islands to the north of Japan. That portion of the Kuroshio that turns eastward between about 35°N and 40°N spreads out to form the broad and slow North Pacific Current. The remaining portion that mixes with the Oyashio north of Japan turns eastward to form the broad and slow Sub Arctic Current. Water is also fed into the Sub Arctic Current by the general southward flow to the east of the Oyashio.

149 Neither the North Pacific Current nor the Sub Arctic Current has limits that can be defined easily from surface observations. Nevertheless, because of their different origins, they do have distinctive water characteristics and are known to be separated by a rapid meridional change in water properties called the Sub Arctic Boundary. Over most of the North Pacific Ocean this boundary is found within a few degrees of 40°N. Within about 1 000 miles of the coast of California however, the Sub Arctic Boundary begins to dip to near 35°N and eventually disappears as it approaches the coast of North America. Since both the North Pacific Current and the Sub Arctic Current are continually being modified by prevailing winds and air temperatures over the ocean they tend to be weak and variable flows with an average eastward drift of about 2 to 4 nautical miles per day.

150 **To the east of about 150°W** the North Pacific Current turns south eastward where it enters the Subtropics as a part of the general clockwise rotation over the southern half of the North Pacific. The Sub Arctic Current divides into two separate branches upon approaching the west coast of North America – the more northerly branch setting north eastward into the Gulf of Alaska as the Alaska Current, and the more southerly branch setting south eastward toward the tropics as the California Current. In keeping with the poorly established flow of the Sub Arctic Current its division into two branches is by no means abrupt. Rather the process takes place throughout a region between about 45°N to 50°N and from 130°W to 150°W. Within this region currents are somewhat mixed with many meanders and eddies of various sizes varying from tens of miles to hundreds of miles embedded in the main flow. Although the latter tends to be persistent in direction, at speeds less than ¼ kn for periods of months, currents associated with eddies may be in any direction and have speeds that exceed ½ kn.

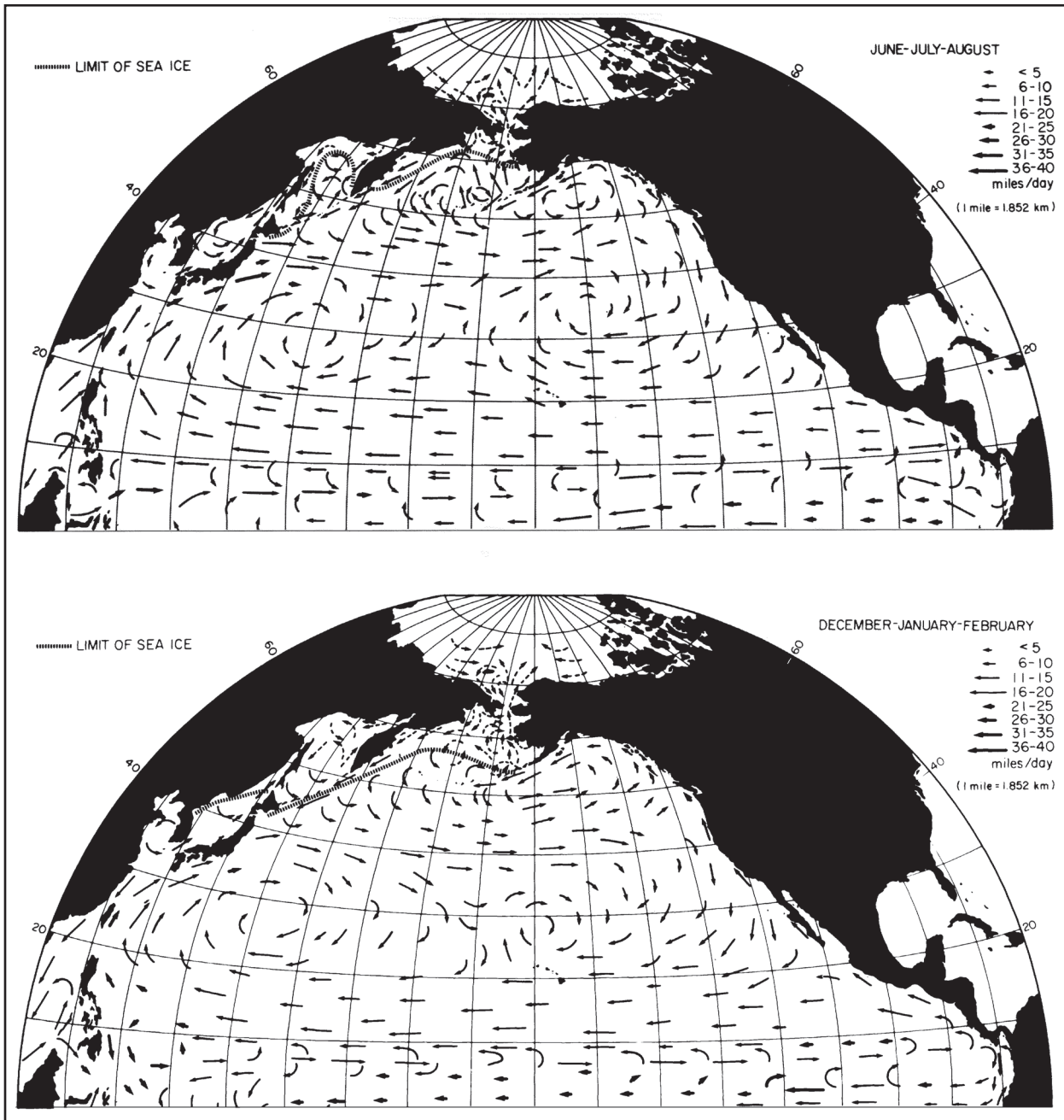

Distribution of Surface Currents of the North Pacific Ocean

(Adapted from U.S. Pilot Charts by Tabata, 1975 in Atmosphere, Vol. 13, No. 4.)

151 In general, division of the Sub Arctic Current into two branches will be more confined to the SE portion of the division region during winter (October–March), than in summer (May–September). Speeds of currents and abruptness of the splitting process will be most pronounced in winter, these features being a consequence of strong and well-established wind systems at that time.

152 Off the continental shelf of Haida Gwaii and SW Alaska the Alaska Current is the dominant oceanic current. Flow in this area is predominantly to the north at speeds between 0.1 to 0.5 kn throughout the year. In winter, these currents can intensify to speeds over 1 kn during persistent south to south easterly winds. In summer near-shore flow may be occasionally reversed by strong winds from the north to NW.

GENERAL CIRCULATION (MEAN DRIFT IN KNOTS)

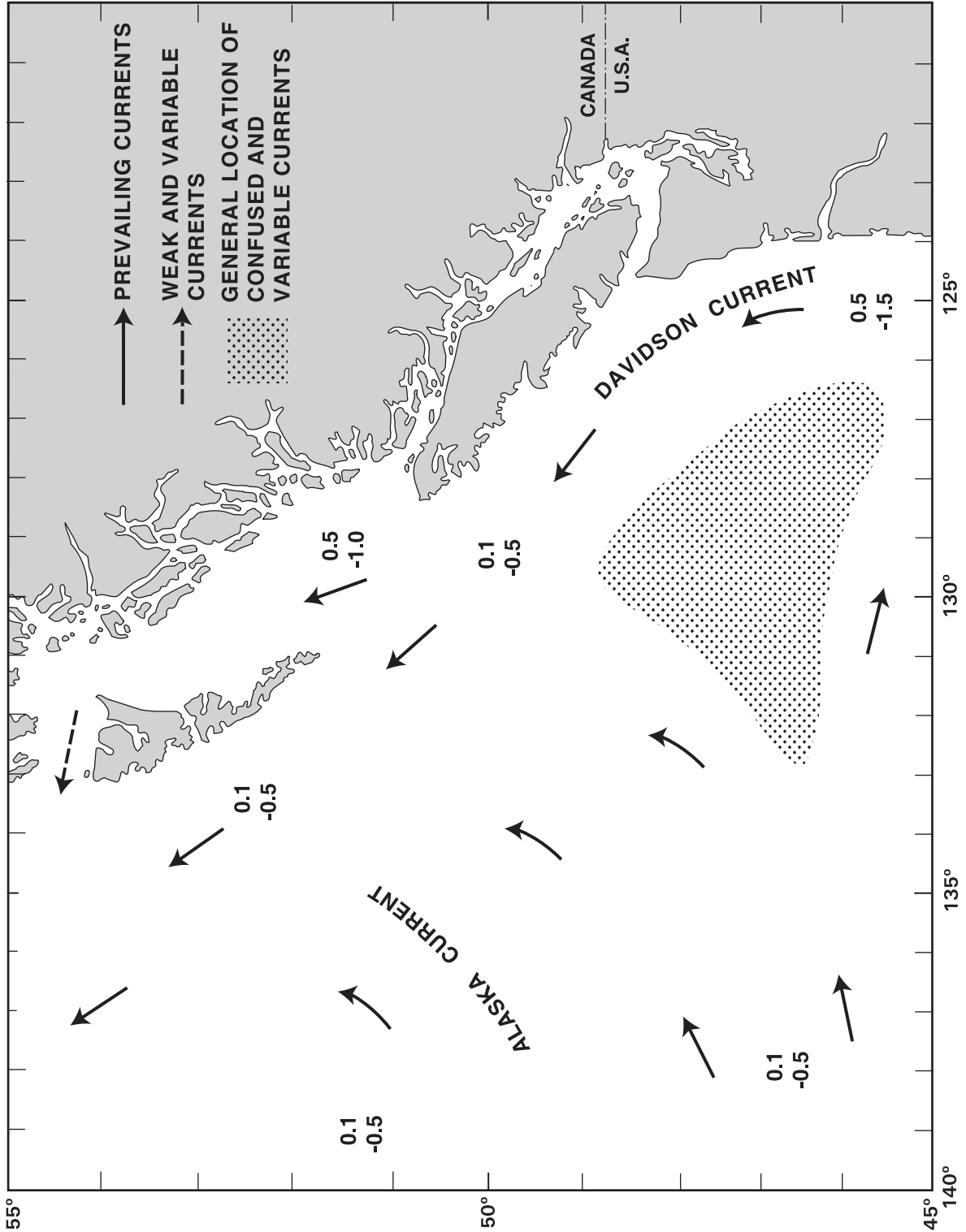

WINTER (December, January, February)

GENERAL CIRCULATION
(MEAN DRIFT IN KNOTS)

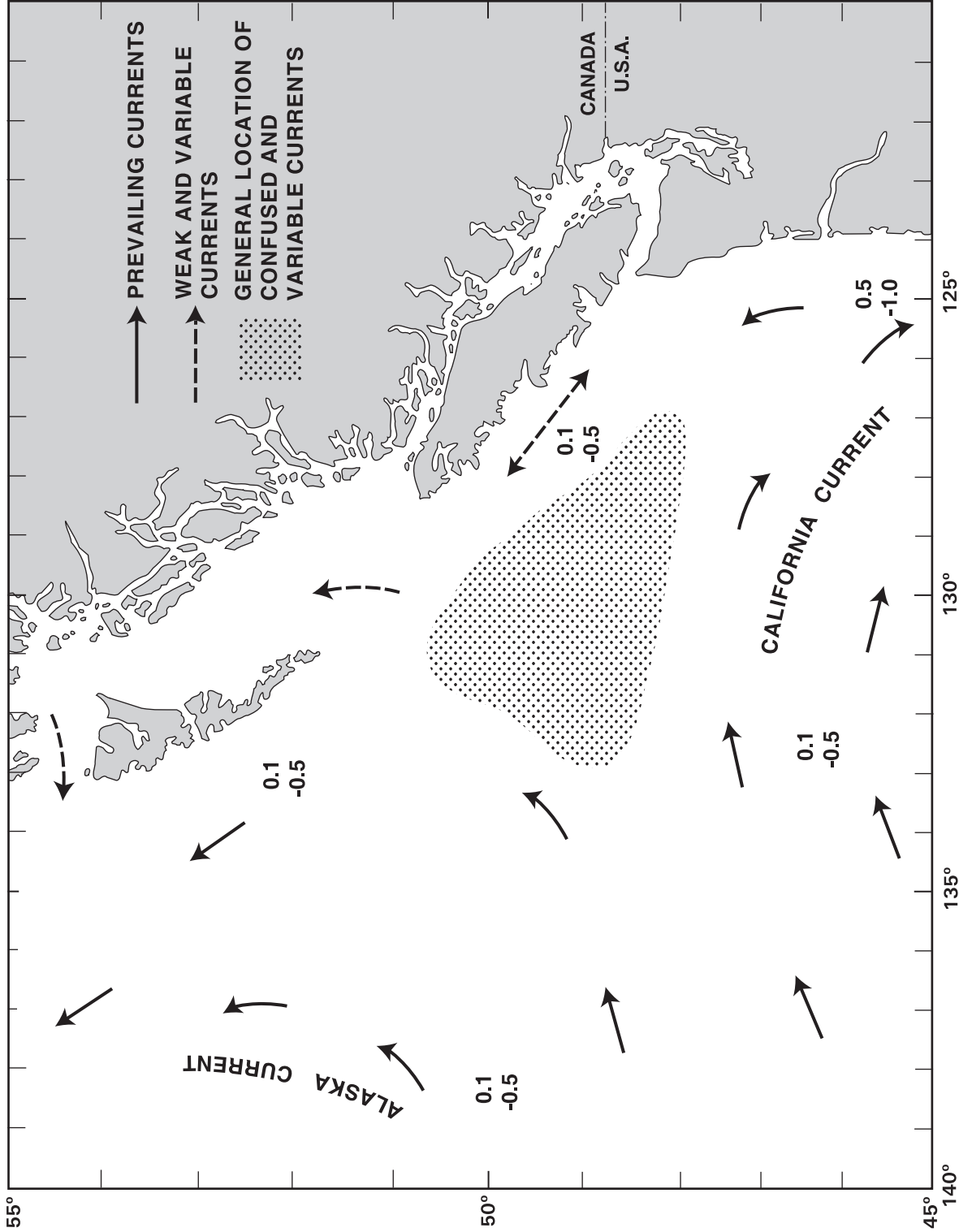

SPRING (March, April, May)

GENERAL CIRCULATION (MEAN DRIFT IN KNOTS)

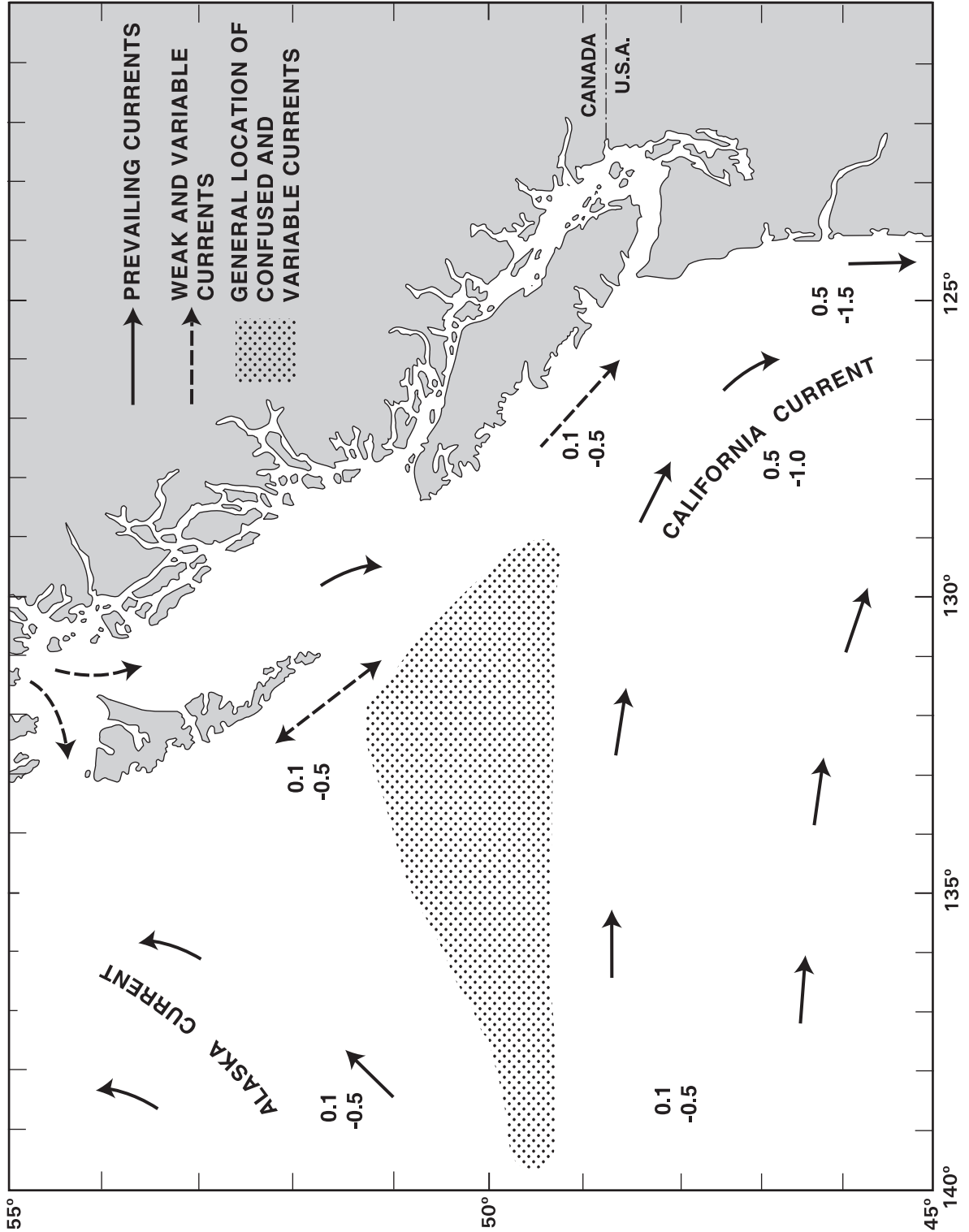

SUMMER (June, July, August)

GENERAL CIRCULATION
(MEAN DRIFT IN KNOTS)

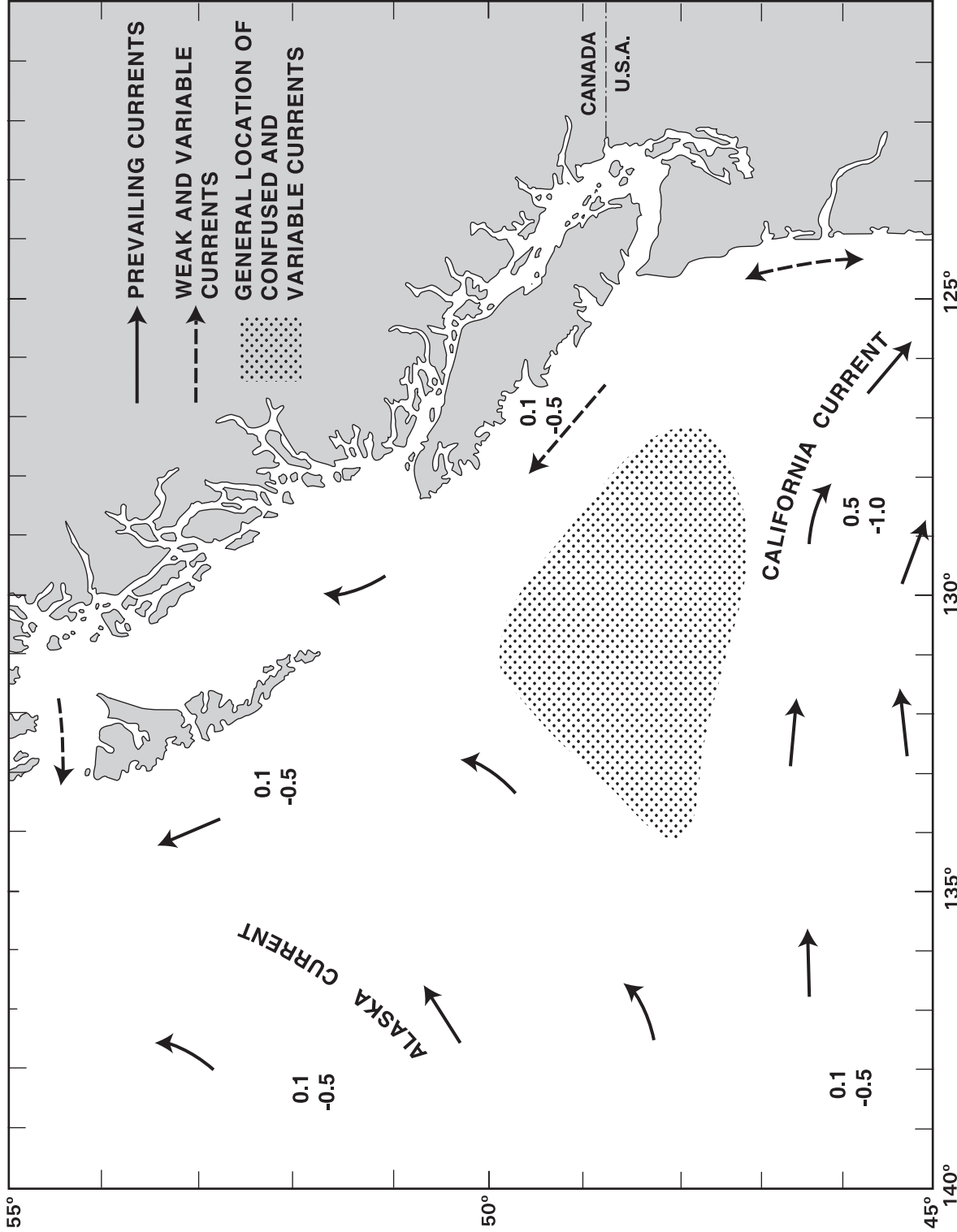

AUTUMN (September, October, November)

Note: November has, in many respects, the characteristics of currents in Dec. - Feb., particularly with regard to the Davidson Current.

At such times the Alaska Current is forced seaward whereby its near-shore boundary will be characterized by eddies and irregular current patterns.

153 **Off the west coast of Vancouver Island** non-tidal currents are generally directed to the NW in winter at speeds of 0.1 to 0.5 kn although strong flows as large as 2 kn have been reported. In part, the winter intensification of the northward flow in this region is due to the overall strengthening of the Alaska Current and the shifting of the division region of the Sub Arctic Current to the SE. Closer to shore, over the continental shelf, currents are stronger and respond more quickly to changes in wind. Beginning around October in this region, when winds begin to shift from north westerly to south easterly along the coast, flow within about 100 miles of the shore shifts from the weak southerly currents associated with the Davidson (Inshore) Current to the somewhat northerly flow associated with the Davidson (Inshore) Current. With persistent south easterly winds in winter inshore flow is predominantly to the north and southward reversals occur infrequently, always driven by north westerly winds. By January and February maximum northward speeds up to 2 kn are possible over the continental shelf during strong south easterly winds.

154 Beginning in May, winds off the Vancouver Island coast start shifting to the NW with a corresponding reversal in the direction of the coastal currents. Offshore the current sets SE at around ½ kn, however, within 10 miles of the coast it continues to set NW at around ¼ kn. In both cases the current may be either strengthened or reversed with strong winds. Well off the continental shelf the SE current becomes part of the California Current.

155 **At the entrance to Juan de Fuca Strait** detailed early observations taken for 2½ years from the Swiftsure Bank Light Vessel have indicated a persistent north westerly set of surface water on the Vancouver Island side. These currents are greatest during periods of SE winds and least during NW winds. Work by Tully in 1941 verified these findings. He also suggested that the strong north westerly flow on the north shore of the strait as far as Cape Beale could be associated with large counter-clockwise eddies that develop at the approach to this area. Satellite-derived information shows the Tully Eddy (also denoted Juan de Fuca Eddy) as a semi-permanent feature.

 156 **Caution.** — **The NW set of the current across the entrance of Juan de Fuca Strait will carry ships toward the Vancouver Island side where scores of ships have foundered. Mariners should exercise extreme caution in this region, particularly in thick weather.**

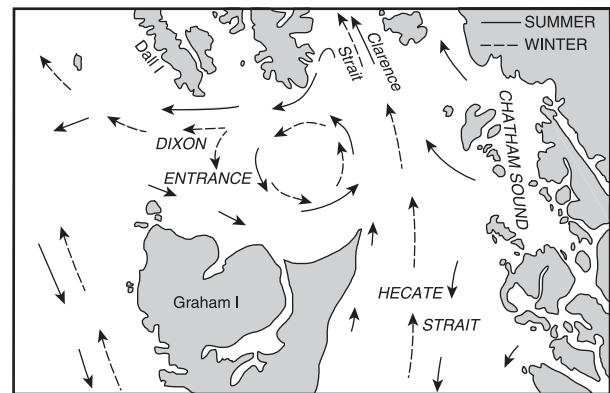

NON - TIDAL SURFACE CURRENTS

Summer conditions correspond to NW winds and a large river runoff; winter conditions to SE winds and a low runoff.

Waves

157 **Sea and Swell.** — Information on seasonal distribution of wave heights, periods and directions in the North Pacific Ocean has been derived mostly from decades of visual estimates reported by officers of deep-sea vessels. **Wave statistics** have been reproduced from tables in the *United States Navy Marine Climatic Atlas of the World, Volume II, North Pacific Ocean*. In these tables the higher of the sea or swell is selected for summarization. If heights are equal the wave with the longer period is selected.

158 **The first block of tables** shows wave height versus wave period. For example, during January in the area west of Haida Gwaii and Vancouver Island waves with a height of 0–0.5 m and a period of less than 6 seconds, occur 2% of the time. Waves 8–9.5 m high with a period of 6–7 seconds occur less than 0.5% of the time. Number of observations for this area in January was 1 737.

159 **The second block of tables** shows wave height versus wave direction. The percentage scale at the top refers only to the bar opposite the direction. For example, during January in the area west of Haida Gwaii and Vancouver Island, waves from the north occur 10% of the time and waves from the west 22% of the time. Figures within the table are the percentage frequency of wave heights and direction. For example in the aforementioned table a wave 0–1 m from the north occurs less than 0.5% of the time. A wave 2–3 m high from the west occurs 7% of the time. Number of observations for this area in January was 1 730.

160 Direct measurements of wave heights have been taken at Cobb Seamount ($46^{\circ}45'N, 130^{\circ}50'W$), Ocean Weather Station Papa ($50^{\circ}00'N, 145^{\circ}00'W$), and a buoy moored 4 miles west of Long Beach on Vancouver Island ($49^{\circ}01'N, 125^{\circ}50'W$).

WAVE STATISTICS

AREA WEST OF QUEEN CHARLOTTE AND VANCOUVER ISLANDS

JANUARY

Height (m)	PERIOD (SECONDS)					IND
	<6	6-7	8-9	10-11	12-13	
0-0.5	2	+	0	0	0	6
1-1.5	9	9	3	1	+	+
2-2.5	5	10	8	3	1	+
3-3.5	1	7	5	4	2	1
4-5.5	1	3	5	2	1	1
6-7.5	0	1	2	2	+	+
8-9.5	0	+	1	0	+	1
≥ 10	0	0	0	+	+	0

1737

APRIL

Height (m)	PERIOD (SECONDS)					IND
	<6	6-7	8-9	10-11	12-13	
0-0.5	5	+	+	+	0	0
1-1.5	19	10	5	1	+	+
2-2.5	7	9	7	3	1	+
3-3.5	2	7	4	2	1	1
4-5.5	+	2	4	1	+	+
6-7.5	0	+	+	+	+	0
8-9.5	0	+	+	+	+	+
≥ 10	0	0	+	+	+	0

2045

JULY

Height (m)	PERIOD (SECONDS)					IND
	<6	6-7	8-9	10-11	12-13	
0-0.5	14	2	1	+	0	0
1-1.5	25	20	6	2	+	+
2-2.5	3	6	5	1	+	+
3-3.5	+	1	2	1	+	0
4-5.5	+	1	+	+	+	0
6-7.5	0	+	0	0	0	0
8-9.5	0	0	0	0	0	0
≥ 10	0	0	0	0	0	0

1973

OCTOBER

Height (m)	PERIOD (SECONDS)					IND
	<6	6-7	8-9	10-11	12-13	
0-0.5	3	1	+	+	0	0
1-1.5	9	10	4	1	+	+
2-2.5	3	12	10	3	1	+
3-3.5	1	5	7	3	2	1
4-5.5	+	2	4	3	3	1
6-7.5	0	+	1	1	+	1
8-9.5	0	+	1	0	+	1
≥ 10	0	0	0	+	0	0

1948

PERCENT

	0	20	40	60	80
N	+	2	2	2	1
NE	+	2	1	+	+
E	+	2	2	1	+
SE	+	2	1	1	+
S	+	4	4	2	2
SW	+	4	6	4	4
W	+	3	7	5	4
NW	+	4	4	3	2
CALM	6	1	+	+	+
TOTALS	8	23	29	20	14

1730

PERCENT

	0	20	40	60	80
N	1	2	1	1	+
NE	+	1	+	+	0
E	+	1	+	+	0
SE	+	2	2	1	1
S	1	4	4	3	1
SW	+	6	4	3	2
W	1	11	9	5	3
NW	2	9	6	3	1
CALM	2	1	+	+	+
TOTALS	8	38	27	16	9

2031

PERCENT

	0	20	40	60	80
N	1	4	2	1	+
NE	+	1	+	+	0
E	+	1	+	+	0
SE	1	2	1	+	+
S	2	6	1	+	+
SW	3	9	3	1	+
W	5	19	6	2	+
NW	4	13	4	1	+
CALM	5	1	+	0	0
TOTALS	20	58	16	5	1

1931

PERCENT

	0	20	40	60	80
N	+	1	1	1	+
NE	+	1	+	+	+
E	+	1	+	+	0
SE	+	2	2	2	1
S	1	5	5	4	2
SW	1	4	6	4	3
W	+	7	9	6	5
NW	+	4	5	2	2
CALM	+	1	1	+	+
TOTALS	4	27	30	19	15

1940

AREA WEST OF WASHINGTON AND OREGON COASTS

Height (m)	PERIOD (SECONDS)					IND
	<6	6-7	8-9	10-11	12-13	
0-0.5	8	3	+	+	0	0
1-1.5	16	11	2	1	1	+
2-2.5	3	6	7	4	2	+
3-3.5	1	3	5	3	1	1
4-5.5	1	2	3	2	2	2
6-7.5	0	+	+	+	+	1
8-9.5	0	+	+	0	+	0
≥ 10	0	0	0	0	0	0

1554

Height (m)	PERIOD (SECONDS)					IND
	<6	6-7	8-9	10-11	12-13	
0-0.5	6	3	1	1	0	0
1-1.5	11	15	9	1	1	+
2-2.5	5	7	8	3	2	+
3-3.5	1	2	4	3	2	1
4-5.5	+	2	2	3	2	1
6-7.5	0	+	+	1	1	+
8-9.5	0	0	+	+	0	+
≥ 10	0	0	0	0	0	0

1575

Height (m)	PERIOD (SECONDS)					IND
	<6	6-7	8-9	10-11	12-13	
0-0.5	13	3	+	+	0	0
1-1.5	28	18	7	2	+	+
2-2.5	5	8	3	1	+	+
3-3.5	1	2	1	1	0	+
4-5.5	+	1	+	+	0	0
6-7.5	0	0	0	0	0	0
8-9.5	0	0	0	0	0	0
≥ 10	0	0	0	0	0	0

1583

Height (m)	PERIOD (SECONDS)					IND
	<6	6-7	8-9	10-11	12-13	
0-0.5	4	3	+	+	0	0
1-1.5	10	12	10	3	1	+
2-2.5	3	8	12	6	1	+
3-3.5	1	3	5	4	3	1
4-5.5	1	1	3	1	1	1
6-7.5	0	0	+	+	+	+
8-9.5	0	0	+	0	0	+
≥ 10	0	0	0	0	0	0

1565

PERCENT

	0	20	40	60	80
N	1	3	1	1	1
NE	+	1	1	+	+
E	+	2	+	+	+
SE	2	2	2	1	1
S	1	5	3	3	3
SW	1	6	4	3	3
W	2	6	6	4	2
NW	2	4	5	2	1
CALM	5	+	1	+	0
TOTALS	16	31	22	15	12

1546

PERCENT

	0	20	40	60	80
N	3	8	3	1	1
NE	1	1	1	+	+
E	+	1	+	+	0
SE	1	1	+	+	+
S	+	3	2	1	1
SW	1	4	4	3	2
W	2	8	8	4	4
NW	2	12	7	3	2
CALM	1	1	+	+	0
TOTALS	11	38	25	13	10

1565

PERCENT

	0	20	40	60	80
N	6	23	8	2	+
NE	1	2	1	+	+
E	+	+	0	0	0
SE	+	1	+	0	0
S	+	3	2	+	+
SW	1	3	1	+	+
W	2	8	3	1	0
NW	4	16	4	1	+
CALM	3	+	+	0	0
TOTALS	18	57	19	5	1

1566

PERCENT

	0	20	40	60	80
N	1	7	4	2	1
NE	+	2	1	+	+
E	1	+	+	+	0
SE	+	1	1	+	0
S	+	3	5	2	1
SW	1	5	4	3	1
W	2	9	8	7	2
NW	1	9	7	3	2
CALM	1	+	+	+	+
TOTALS	7	36	31	17	11

1558

+ indicates < 0.5% but > 0.

161 Comparisons between visual and measured wave heights reveal that mariners consistently underestimate lower wave heights, but are generally accurate for high waves. Wave statistics obtained by visual estimates appear to be fairly reliable. However, due to routing of vessels they are biased toward good weather conditions and are dubious in areas away from major shipping routes.

162 **Ocean Weather Station Papa** is the only one of the three locations used for direct measurements of waves that is representative of a truly deep-sea environment. Wave directions are almost identical to corresponding wind directions and are from the SW and NW quadrants roughly 70% of the time. It is also the direction from which the largest waves arrive.

163 Mean significant wave height for all seasons is a maximum of around 5.5 m, for waves from the SW to NW quadrants, and about 2.5 m from the NE quadrant. Average significant wave heights range from 5 to 5.5 m between October and April, and from 1.2 to 2 m between June and August increasing abruptly again to around 5 m in September.

164 Peak period of waves at Ocean Weather Station Papa is 9 to 10 seconds and occurs about 18% of the time. Very long swells with a period of 17 to 20 seconds occur about 6% of the time. Wave heights undergo an appreciable daily variation, regardless of season, in this area of the North Pacific Ocean. Even during months of relatively low average waves there can be periods of exceptionally high waves, and vice versa.

 165 **Mountainous waves greater than 12 m high can occur in any part of the North Pacific Ocean with the possible exception of the south central portion.** At Ocean Weather Station Papa mountainous waves, 12 to 15 m high, were observed on seven occasions between 1951 and 1963 all during the months November to March. The wave period at Cobb Seamount is significantly longer, 12 seconds, compared to 9 seconds at Ocean Weather Station Papa.

166 Wave data have been collected off **Long Beach** on Vancouver Island since 1970. Significant wave heights averaged over all seasons are 1.2 to 2 m over 55% of the time, 2 to 3 m about 31%, and 3 to 6 m about 13%. The most common wave period of 10 seconds occurs about 18% of the time and waves with periods of 10 seconds or more occur about 50% of the time while maximum periods of 20 seconds occur around 5%. Only 6% of all waves have periods shorter than 6 seconds. Day-to-day variability to be expected for waves close-off the coast is similar to Station Papa with generally lower heights.

167 No direct measurements of waves have been made in **Juan de Fuca Strait**. Generally seas associated with offshore winds rarely progress very far inland before they meet the shore. Seas are primarily in alignment with the axis of the strait. Swell propagating inland from the ocean increase the overall height of seas and cause them to steepen. Even a

large deep ocean swell will be reduced to a low ground swell by the time it reaches the east portion of the strait. Near the entrance of the strait waves can be expected to exceed 6 m high 10% of the time in winter and 3 m high 10% of the time in summer. Inside the strait, because the fetch is always less than 75 miles, fully developed seas would not usually be expected to exceed heights of 2 m. Dangerous rips occur off prominent points, over banks and in the approaches to Haro and Rosario Straits when the tidal stream opposes the sea.

168 Wave heights in the **Strait of Georgia** are limited by the fetch of the wind that is further limited by obstructions such as Texada Island. Recorded wave measurements have been taken at several locations in the Strait of Georgia. Off Sturgeon Bank maximum wave heights were always less than 4 m and off Roberts Bank they were always less than 3.3 m. Only 10% of the time did maximum wave heights exceed 1.2 m in both localities, however, 60% of the time the maximum waves exceeded 0.3 m. Periods of 5 to 6 seconds occur as much as 30% of the time and the most probable maximum period is 9 seconds off Sturgeon and Roberts Banks.

 169 Highest and steepest waves in the Strait of Georgia occur in rips where strong tidal streams oppose wind waves generated over long fetches. **The approaches to Boundary Pass, Fraser River and Discovery Passage are particularly dangerous because of these rips.** Substantial rips can also form at the Strait of Georgia entrances to Active Pass and Porlier Pass during a flood tidal stream with NW winds or near Point Atkinson during the ebb with SE winds.

170 **In Johnstone Strait and Discovery Passage** seas will be consistently lower than seas observed in the Strait of Georgia. Because surface ebb tidal streams in these two channels are considerably stronger than surface flood tidal streams, the largest seas will develop from winds from the west in Johnstone Strait and from the north in Discovery Passage north of Seymour Narrows. South of Seymour Narrows the largest wave heights will occur on the flood during periods of strong SE winds in the Strait of Georgia.

171 **In Queen Charlotte Strait**, due to greater channel width, seas will be higher and have longer periods than those in Johnstone Strait. Low, eastward propagating swells are commonly found in Queen Charlotte Strait and are the remnants of larger oceanic swell from Queen Charlotte Sound. They undergo a gradual reduction in height as they move inland.

172 **In Queen Charlotte Sound, Hecate Strait and Dixon Entrance** measurements of wave heights were taken at six locations between October 1982 and May 1984. Wave statistics, compared with data obtained in other areas of the world, indicate that Queen Charlotte Sound is comparable to Hibernia, on the Grand Banks of Newfoundland, and slightly more severe than in the central North Sea. Dixon Entrance and Hecate Strait are less severe and comparable with the

North Sea although greater background energy, associated with swell, is present in Dixon Entrance. Hecate Strait, though less exposed to swell than the site in Dixon Entrance west of Learmonth Bank, is more severe in terms of large-wave occurrence except during the summer.

173 **In the entrance of Queen Charlotte Sound** ($51^{\circ}18.5'N$, $129^{\circ}57.6'W$), mean and maximum significant wave heights are:

Mar–May 2.7–9.5 m
Jun–Aug 1.7–4.1 m
Sep–Nov 2.9–10.4 m
Dec–Feb 4.0–11.4 m
Maximum wave height 18.5 m

174 **In Queen Charlotte Sound SW of McInnes Island** ($52^{\circ}06.8'N$, $128^{\circ}57.5'W$) interruptions to measurements during winter months may have introduced biased statistics; mean and maximum significant wave heights are:

Mar–May 2.4–7.3 m
Jun–Aug 1.1–3.8 m
Sep–Nov 1.7–6.7 m
Dec–Feb 3.9–6.8 m
Maximum wave height 12.4 m

175 An example of very high waves was recorded in 1968 from an oil rig moored in 137 m of water in Queen Charlotte Sound. Two late October storms in tandem maintained seas in excess of 3 m for sixteen consecutive days. At the height of these storms waves were recorded from 9 to 15 m high and reached 20 m on October 22. A giant wave recorded between 27 and 30 m high developed during the latter storm.

176 **In the south entrance to Hecate Strait** ($52^{\circ}11.6'N$, $130^{\circ}20.5'W$), mean and maximum significant wave heights are:

Mar–May 2.2–8.8 m
Jun–Aug 1.1–3.7 m
Sep–Nov 1.9–9.2 m
Dec–Feb 3.0–10.7 m
Maximum wave height 19.8 m

177 **In Hecate Strait SW of Bonilla Island** ($53^{\circ}21.2'N$, $130^{\circ}46.7'W$), interruptions to measurements and no measurements during summer months may have introduced biased statistics; mean and maximum significant wave heights are:

Mar–May 1.2–5.6 m
Sep–Nov 1.6–8.2 m
Dec–Feb 1.7–6.8 m

178 **In Dixon Entrance** measurements were taken west and east of Learmonth Bank. West of Learmonth Bank ($54^{\circ}26.9'N$, $133^{\circ}19.4'W$), mean and maximum significant wave heights are:

Mar–May 2.5–7.9 m
Jun–Aug 1.6–4.3 m
Sep–Nov 2.6–9.0 m
Dec–Feb 3.2–8.8 m

Maximum wave height 15.2 m

179 **East of Learmonth Bank** ($54^{\circ}26.2'N$, $132^{\circ}48.3'W$), mean and maximum significant wave heights are:

Mar–May 2.1–6.9 m
Jun–Aug 1.2–3.5 m
Sep–Nov 2.2–6.7 m
Dec–Feb 2.9–7.3 m
Maximum wave height 13.6 m

180 Wave measurements were obtained in **Chatham Sound** from a wave rider buoy moored about 1.5 miles west of Prince Rupert Harbour from September 1972 to June 1973. Most waves were found to be lower than 1 m high and to have periods of 2 to 5 seconds. Low swells entering the sound from Dixon Entrance were common and swell periods of 8 to 10 seconds accounted for 20% of the wave observations. Only 10% of the swells were higher than 1 m. During the observation period the significant wave heights remained below 3 m. In winter the eastward propagating swell often persisted for two to three days but with wave heights in excess of 2 m for less than a day each time.

Tsunami

181 The Japanese word for “harbour wave”, tsunami or seismic sea wave refers to a group of waves of long period and wave length produced by an underwater disturbance. Tsunamis are often erroneously referred to as “tidal waves”. Most tsunamis are associated with strong earthquakes, magnitude 7 or larger on the Richter scale, in which epicentres are within or border the ocean floor. Volcanic eruptions, submarine landslides, or avalanches into coastal waters may also produce tsunamis.

182 Once generated in the deep ocean, waves spread rapidly away from their source and attain speeds up to 500 kn. The interval between successive crests is typically from 10 to 40 minutes. In the open sea the height of the wave is small, perhaps a fraction of a metre, and is normally not detectable from a ship. However, in coastal waters waves slow down in rate of travel and increase in heights with diminishing depths and can be very large and destructive. In shallow harbours or inlets tsunamis may appear as a fast rising or falling tide accompanied by strong currents, as a bore or wall of water or occasionally as a crashing wave. Waves may excite natural resonance periods in harbours and can continue for one or more days. The first wave is not necessarily the largest and sometimes the greatest danger may occur several hours after the arrival of the first wave.

183 About 80% of all tsunamis occur in the Pacific. Studies of tide records from Tofino show that large tsunamis have reached the Canadian west coast from Chile, Alaska, Aleutian Islands, Kamchatka, Kuril Islands and northern Japan.

184 The west coast of Vancouver Island is extremely vulnerable to major tsunamis set up by earthquakes along the Cascadia Subduction Zone, which lies a few hundred kilometres to the west. Tsunamis of up to 10 m height or larger may hit this coast. These events occur every 300 to 900 years, as determined by examination of sediments long the coast of B.C., Washington State and Oregon. Tsunamis from Cascadia Subduction zone earthquakes will hit the west coast of Vancouver Island within 20 minutes after the earthquake. It will reach Victoria in one to two hours. Tsunami currents in harbours and especially at entrances to harbours will be dangerous. The heights of such a tsunami will diminish to several meters as it progresses into Juan de Fuca Strait and into northern B.C. Simulations of this tsunami show currents of more than 15 knots at the entrances to Esquimalt and Victoria Harbours. **Ships in harbours of southern B.C. should not attempt to depart the harbour for the safety of deeper waters if there is any chance of encounter with the tsunami in the harbour entrance.** The initial tsunami wave is not necessarily the largest and such waves will persist for hours.

185 The most recent Cascadia tsunami destroyed at least one First Nations village, located in Pachena Bay. Non-natives have not experienced such an event, and the next one, due in the next several hundred years, may cause death and destruction. Mariners should expect the wave to be as big as the Asian tsunami of 2004.

186 In addition, submarine landslides, such as occurred in Kitimat Harbour in 1975, may produce locally destructive waves. Such events are infrequent, but are a possibility near river deltas or in places where sediments are being deposited or disturbed. Strong local earthquakes (over magnitude 7) usually trigger such tsunamis in B.C. waters. However, the danger zone rarely extends beyond the basin where the landslide takes place.

187 The largest tsunami on the Canadian west coast in the past 200 years originated from the Anchorage, Alaska area

in 1964. Inlets and harbours on the west coast of Vancouver Island, Haida Gwaii, and the coast north of Vancouver Island received large waves. At Port Alberni waves arrived at intervals of about 90 minutes and the largest may have had a height from trough to crest of 8 m. Its maximum height reached more than 2 m above the highest tide level and flooded over dykes into the city. The lowest troughs, though not visible in the darkness, may have run out to more than 2 m below lowest normal tides.

188 **Hazards to shipping** in such a tsunami come from strong currents, perhaps ten times larger than during normal tides, dragging anchor or breaking loose from docks, and being driven ashore or left aground. Navigation is made more hazardous by turbulent currents, logs set adrift, and by lights and navigation aids being destroyed or moved.

189 **The International Tsunami Warning System** centred near Honolulu, Hawaii, ascertains as soon as possible after a major earthquake whether a dangerous tsunami has been generated. Canada maintains special tide stations, at Tofino, Winter Harbour and Langara Island, as part of this warning system.

190 Tsunami warnings for the Canadian west coast are disseminated by British Columbia Provincial Emergency Program (PEP) Authorities, through the RCMP, to coastal communities and shipping in harbour, as well as via Coast Guard MCTS Centres for ships approaching or leaving the coast. These warnings are most effective if the arrival time is more than a few hours after the earthquake. For example, Alaskan tsunamis require more than three hours to reach British Columbia, and mariners can expect to hear warnings over marine and commercial radio. Cascadia Subduction zone tsunamis might arrive before authorities are able to notify mariners and the general public.

Sail Plan

Adapted from Transport Canada Publication TP 511E.

Fill out a sail plan for every boating trip you take and file it with a responsible person. Upon arrival at your destination, be sure to close (or deactivate) the sail plan. Forgetting to do so can result in an unwarranted search for you.

Sail Plan

Owner Information

Name: _____

Address: _____

Telephone Number: _____ Emergency Contact Number: _____

Boat Information

Boat Name: _____ Licence or

Registration Number: _____

Sail: _____ Power: _____ Length: _____ Type: _____

Colour _____ Hull: _____ Deck: _____ Cabin: _____

Engine Type: _____ Distinguishing Features: _____

Communications

Radio Channels Monitored: HF: VHF: MF:

MMSI (Maritime Mobile Service Identity) Number: _____

Satellite or Cellular Telephone Number: _____

Safety Equipment on Board

Lifejackets and PFD's (include number): _____

Liferafts (include type and colour): _____ Dinghy or Small Boat
(include colour): _____

Flares (include number and type): _____

Other Safety Equipment: _____

Trip Details — Update These Details Every Trip

Date of Departure: _____ Time of Departure: _____

Leaving From: _____ Heading To: _____

Proposed Route: _____ Estimated Date and

Stopover Points (include date and time): _____ Time of Arrival: _____

_____ Number of People on Board: _____

Search and Rescue Telephone Number: _____

The responsible person should contact the nearest Joint Rescue Coordination Centre (JRCC) or Maritime Rescue Sub-Centre (MRSC) if the vessel becomes overdue.

Act smart and call early in case of emergency. The sooner you call, the sooner help will arrive.

JRCC Victoria (British Columbia and Yukon) 1-800-567-5111

+1-250-413-8933 (Satellite, Local or out of area)

727 (Cellular)

+1-250-413-8932 (fax)

jrccvictoria@sarnet.dnd.ca (Email)

JRCC Trenton (Great Lakes and Arctic) 1-800-267-7270

+1-613-965-3870 (Satellite, Local or Out of Area)

+1-613-965-7279 (fax)

jrcctrenton@sarnet.dnd.ca (Email)

MRSC Québec (Quebec Region) 1-800-463-4393

+1-418-648-3599 (Satellite, Local or out of area)

+1-418-648-3614 (fax)

mrscqbc@dfo-mpo.gc.ca (Email)

JRCC Halifax (Maritimes Region) 1-800-565-1582

+1-902-427-8200 (Satellite, Local or out of area)

+1-902-427-2114 (fax)

jrcchalifax@sarnet.dnd.ca (Email)

MRSC St. John's (Newfoundland and Labrador Region) 1-800-563-2444

+1-709-772-5151 (Satellite, Local or out of area)

+1-709-772-2224 (fax)

mrscsj@sarnet.dnd.ca (Email)

MCTS Sail Plan Service

Marine Communications and Traffic Services Centres provide a sail plan processing and alerting service. Mariners are encouraged to file Sail Plans with a responsible person. In circumstances where this is not possible, Sail Plans may be filed with any MCTS Centre by telephone or marine radio only. Should a vessel on a Sail Plan fail to arrive at its destination as expected, procedures will be initiated which may escalate to a full search and rescue effort. Participation in this program is voluntary. *See Canadian Radio Aids to Marine Navigation.*

DISTANCES — INSIDE PASSAGE

PRINCE RUPERT TO CAPE CAUTION VIA GRENVILLE, PRINCESS ROYAL AND SEAFORTH CHANNELS; LAMA PASSAGE, FITZ HUGH SOUND

Prince Rupert

72	Sainty Point													
100	28	Butedale												
121	49	67	Kitimat											
158	58	65	57	Kemano										
135	63	35	102	104	Boat Bluff									
161	89	61	126	128	26	Susan Rock								
180	108	80	147	145	45	20	Bella Bella							
190	118	90	157	155	55	30	10	Pointer Island - E end Lama Passage						
210	138	110	167	176	63	50	30	20	Ocean Falls					
255	183	165	213	211	119	86	61	56	54	Bella Coola via Burke Channel				
203	131	103	181	179	68	42	23	12	33	56	Namu			
222	150	122	189	191	87	61	42	32	51	66	20	Safety Cove		
232	160	132	199	201	98	71	52	42	61	86	30	10	Dugout Rocks	
245	173	145	212	214	110	84	65	55	74	99	43	23	13	Cape Caution Lt - 078° 2.2 miles

Distances are approximate and expressed to the nearest nautical mile.
 Distances are based on the most frequently used tracks which may not be suitable for all vessels.

PRINCE RUPERT TO QUEEN CHARLOTTE ISLANDS

Prince Rupert

9	Holland Rocks										
28	19	Seal Rocks									
80	71	52	Lawn Point Buoy								
91	81	63	11	Sandspit							
99	89	71	19	8	Queen Charlotte						

Distances are approximate and expressed to the nearest nautical mile.
 Distances are based on the most frequently used tracks which may not be suitable for all vessels.

PRINCE RUPERT TO EAST COAST OF QUEEN CHARLOTTE ISLANDS

Prince Rupert

9	Holland Rocks										
28	19	Seal Rocks									
95	86	67	Cumshewa Head								
99	90	71	11	Reef Island							
122	113	94	38	27	Scudder Point						
128	119	100	44	33	6	Copper Islands					
136	127	108	56	45	18	12	Garcin Rocks				
158	149	130	73	62	35	29	17	Cape St James			

Distances are approximate and expressed to the nearest nautical mile.
 Distances are based on the most frequently used tracks which may not be suitable for all vessels.

DISTANCES — INSIDE PASSAGE

WEST COAST QUEEN CHARLOTTE ISLANDS, CAPE ST. JAMES TO LANGARA POINT

Cape St. James

14	Anthony Island						
39	25	Gowgaia Bay entrance					
67	53	28	Tasu Sound entrance				
101	87	62	34	Marble Island			
126	112	87	59	25	Hippra Island		
151	137	112	84	50	25	Frederick Island	
172	158	133	105	71	46	21	Langara Point

Distances are approximate and expressed to the nearest nautical mile.

Distances are based on the most frequently used tracks which may not be suitable for all vessels.

Note: 3 to 5 miles offshore

WIND TABLES FOR SELECTED LOCATIONS ON THE BRITISH COLUMBIA COAST

Addenbroke Island 51°36'N 127°51'W

Active Station

Elevation: 21.3 m

Wind (km/s)	Jan	Feb	Mar	Apr	May	June	July	Aug	Sept	Oct	Nov	Dec	Year
Speed	15.9	15.4	15	14.6	13.9	14.2	13.1	13.1	12.8	13.8	15.4	15.4	-
Most Frequent Direction	SE	SE	SE	S	N	N	N	N	N	S	SE	SE	-
Maximum Hourly Speed	97 ^a	93	74	97	87	64	52	55	74	84	93	93	-
Direction Max. Hourly Speed	S	SE	S	SE	SE	S	NW	S	SE	SE	SE	NW	S

^a All-time extreme (1981/22)

Bonilla Island 53°29'N 130°38'W

Active Station

Elevation: 16.2 m

Wind (km/h)	Jan	Feb	Mar	Apr	May	June	July	Aug	Sept	Oct	Nov	Dec	Year
Speed	-	-	-	-	-	23.7	22.4	-	-	-	-	-	-
Most Frequent Direction	-	-	-	-	-	SE	SE	-	-	-	-	-	-
Maximum Hourly Speed	103	143 ^a	119	103	84	82	66	77	87	105	126	116	-
Direction Max. Hourly Speed	SE	S	SE	S	SE	SE	SE	SE	SE	SE	SE	S	S

^a All-time extreme (1974/20)

Bull Harbour 50°55'N 127°57'W

Inactive Station

Elevation: 13.7 m

Wind (km/h)	Jan	Feb	Mar	Apr	May	June	July	Aug	Sept	Oct	Nov	Dec	Year
Speed	13.2	12.7	12	10.2	9.2	7.4	6.1	5.5	6.8	9.7	13.5	13.5	10
Most Frequent Direction	SE	SE	SE	SE	NW	NW	NW	NW	SE	SE	SE	SE	SE
Maximum Hourly Speed	121	129 ^a	97	97	72	64	80	48	89	113	113	113	-
Direction Max. Hourly Speed	SE	SE	SE	SE	SE	SE	SE	SE	SE	SE	E	SE	SE

^a All-time extreme (1960/06)

Cape Beale Light 48°47'N 125°13'W

Active Station

Elevation: 25.9 m

Wind (km/h)	Jan	Feb	Mar	Apr	May	June	July	Aug	Sept	Oct	Nov	Dec	Year
Speed	17.1	16	17.2	15.8	14.6	14.2	12.1	10.5	10.3	13.5	17.1	17.4	-
Most Frequent Direction	SE	SE	SE	SE	SE	SE	SE	SE	SE	SE	SE	SE	-
Maximum Hourly Speed	89	97 ^a	84	84	71	61	56	66	80	77	93	92	-
Direction Max. Hourly Speed	W	SE	SE	SE	NW	SE	NW	W	SE	W	SW	SE	SE

^a All-time extreme (1969/07)

Cape St. James 51°55'N 131°01'W

Inactive Station

Elevation 92.0 m

Wind (km/h)	Jan	Feb	Mar	Apr	May	June	July	Aug	Sept	Oct	Nov	Dec	Year
Speed	38	36	32.2	30.4	27.9	26.3	25.5	24.8	25.1	30.9	36.5	37.7	30.9
Most Frequent Direction	NE	NE	SE	W	NW	W	W	W	W	S	NE	NE	W
Maximum Hourly Speed	154	159	159	158	111	114	93	96	122	177 ^a	142	159	-
Direction Max. Hourly Speed	NW	SE	NE	S	W	SE	E	E	SE	SE	SE	NE	SE
Maximum Gust Speed	189	193 ^b	169	143	154	122	104	126	137	191	181	191	-
Direction Maximum Gust	SE	SE	SE	SE	SE	E	SE	E	W	SE	SE	SE	SE

^a All-time extreme (1963/31)

^b All-time extreme (1978/09)

Cape Scott 50°46'N 128°25'W

Active Station

Elevation: 71.6 m

Wind (km/h)	Jan	Feb	Mar	Apr	May	June	July	Aug	Sept	Oct	Nov	Dec	Year
Speed	18.8	17.9	16.4	15.1	13.5	12.2	10.7	11.2	13.7	16.9	18.9	19.1	-
Most Frequent Direction	SE	SE	SE	SE	NW	NW	NW	NW	NE	SE	SE	SE	-
Maximum Hourly Speed	93	102	93	74	85	78	74	111 ^a	83	111	93	102	-
Direction Max. Hourly Speed	SE	SE	SE	SE	E	SE	SE	SE	SE	SE	E	SE	SE
Maximum Gust Speed	150	135	128	122	111	126	93	91	130	158	146	158 ^b	-
Direction Maximum Gust	SE	SE	SE	SE	SE	SE	SE	SE	SE	S	SE	E	E

^aAll-time extreme (1991/08)

^bAll-time extreme (1994/21)

Chatham Point 50°19'N 125°25'W

Active Station

Elevation: 22.9 m

Wind (km/h)	Jan	Feb	Mar	Apr	May	June	July	Aug	Sept	Oct	Nov	Dec	Year
Speed	12.3	12	13	13.8	15.6	17.2	19.4	17.6	14.1	11.7	12.8	13.3	14.4
Most Frequent Direction	SE	SE	SE	SE	W	W	W	W	W	SE	SE	SE	W
Maximum Hourly Speed	74	102	83	83	74	70	68	83	83	93	83	108 ^a	-
Direction Max. Hourly Speed	NW	NW	SE	SE	NW	NW	SW	NW	NW	SE	NW	E	E

^aAll-time extreme (1988/01)

Comox Airport 49°43'N 124°54'W

Active Station

Elevation: 25.6 m

Wind (km/h)	Jan	Feb	Mar	Apr	May	June	July	Aug	Sept	Oct	Nov	Dec	Year
Speed	12.7	13.4	13.7	12.8	12.4	12.3	11.8	10.9	9.9	11.5	13.8	14.3	-
Most Frequent Direction	SE	SE	SE	SE	SE	SE	NW	NW	W	SE	SE	SE	SE
Maximum Hourly Speed	77	84	81	67	63	64	56	56	64	69	93 ^a	81	-
Direction Max. Hourly Speed	SE	E	E	SE	SE	SE	SW	SE	SE	SE	SE	SE	SE
Maximum Gust Speed	113	114	133	106	90	93	97	78	97	159 ^b	129	121	-
Direction max. gust	SE	E	E	E	SE	SE	E	SE	E	SE	SE	SE	SE

^aAll-time extreme (1962/29)

^bAll-time extreme (1990/02)

Egg Island 51°15'N 127°50'W

Active Station

Elevation: 14.0 m

Wind (km/h)	Jan	Feb	Mar	Apr	May	June	July	Aug	Sept	Oct	Nov	Dec	Year
Speed	26.2	26.1	22.4	20.4	17.3	16.2	14.5	14.2	15.1	22	28.1	27.3	-
Most Frequent Direction	SE	SE	SE	SE	NW	NW	NW	NW	SE	SE	SE	SE	-
Maximum Hourly Speed	119	137 ^a	120	111	133	98	74	81	93	115	113	124	-
Direction Max. Hourly Speed	E	E	SE	E	E	SE	E	E	SE	E	E	E	E

^aAll-time extreme (1999/12)

Estevan Point 49°22'N 126°33'W

Active Station

Elevation: 7.00 m

Wind (km/h)	Jan	Feb	Mar	Apr	May	June	July	Aug	Sept	Oct	Nov	Dec	Year
Speed	-	23.3	24.2	22.5	-	21.7	-	-	-	-	-	-	-
Most Frequent Direction	-	SE	SE	NW	-	NW	-	-	-	-	-	-	-
Maximum Hourly Speed	111	116	115	105	98	100	74	81	83	93	111	132 ^a	-
Direction Max. Hourly Speed	SE	S	W	SE	SE	SE	NW	SE	E	SE	SE	W	W
Maximum Gust Speed	132	148	154	128	138	101	103	144	133	143	167	180 ^b	-
Direction Maximum Gust	W	SE	SE	SE	E	SE	SE	SE	SE	SE	SE	W	W

^aAll-time extreme (1976/08)

^bAll-time extreme (1976/08)

Ethelda Bay 53°03'N 129°40'W
Inactive Station

Elevation: 9.60 m

Wind (km/h)	Jan	Feb	Mar	Apr	May	June	July	Aug	Sept	Oct	Nov	Dec	Year
Speed	-	14.7	-	12	10.4	9.85	8.55	-	-	-	-	-	-
Most Frequent Direction	-	NE	-	SE	SE	SE	NW	-	-	-	-	-	-
Maximum Hourly Speed	93	120 ^a	65	69	65	65	48	65	72	83	74	83	-
Direction Max. Hourly Speed	NE	NE	SE	S	SE	SE	SE	SE	SW	SW	SE	NE	NE

^aAll-time extreme (1980/14)

Kitimat 54°0'N 128°42'W
Active Station

Elevation: 16.80 m

Wind (km/h)	Jan	Feb	Mar	Apr	May	June	July	Aug	Sept	Oct	Nov	Dec	Year
Speed	-	-	-	-	-	-	-	-	-	-	-	-	-
Most Frequent Direction	-	-	-	-	-	-	-	-	-	-	-	-	-
Maximum Hourly Speed	40	34	40 ^a	32	35	32	31	29	35	37	35	39	-
Direction Max. Hourly Speed	SE	S	-	SE	SE	SE	SE	SE	SE	S	NW	N	-

^aAll-time extreme (1971/07)

McInnes Island 52°15'N 128°43'W
Active Station

Elevation: 25.9 m

Wind (km/h)	Jan	Feb	Mar	Apr	May	June	July	Aug	Sept	Oct	Nov	Dec	Year
Speed	-	-	-	-	14.9	15	13.5	12.9	-	-	-	-	-
Most Frequent Direction	-	-	-	-	NW	NW	NW	NW	-	-	-	-	-
Maximum Hourly Speed	130	126	113	119	97	81	74	85	102	124	122	119	-
Direction Max. Hourly Speed	W	S	S	SE	SE	SE	S	SE	SE	SE	SE	SW	W
Maximum Gust Speed	146	137	119	152	104	107	80	81	128	157 ^a	148	141	-
Direction Maximum Gust	SE	S	SE	SE	SE	SE	SE	SE	SE	SE	SE	SE	SE

^aAll-time extreme (1984/12)

Merry Island Lightstation 49°28'N 123°55'W
Active Station

Elevation: 6.10 m

Wind (km/h)	Jan	Feb	Mar	Apr	May	June	July	Aug	Sept	Oct	Nov	Dec	Year
Speed	18.7	19.8	19.5	17.8	16.1	15.8	14.4	14.3	14.6	18	21.9	21.4	-
Most Frequent Direction	E	E	E	NW	NW	SE	NW	NW	NW	NW	E	E	-
Maximum Hourly Speed	97	93	85	89	72	72	69	70	80	89	100 ^a	97	-
Direction Max. Hourly Speed	SE	E	E	E	E	E	E	E	SE	E	SE	E	SE

^aAll-time extreme (1962/29)

Port Alberni Airport 49°15'N 124°49'W
Inactive Station

Elevation 2.4 m

Wind (km/h)	Jan	Feb	Mar	Apr	May	June	July	Aug	Sept	Oct	Nov	Dec	Year
Speed	3.7	4.4	5.3	7.1	8.2	9.4	9.4	8.7	6.2	4.6	4.1	3.4	6.2
Most Frequent Direction	NW	NW	NW	S	S	S	S	S	S	NW	NW	NW	S
Maximum Hourly Speed	56	48	40	50	45	46	48	52	39	47	43	64 ^a	-
Direction Max. Hourly Speed	SE	S	S	S	S	S	SE	S	S	SE	SE	SE	SE

^aAll-time extreme (1969/11)

Port Hardy Airport 50°40'N 127°22'W Active Station

Elevation: 21.6 m

Wind (km/h)	Jan	Feb	Mar	Apr	May	June	July	Aug	Sept	Oct	Nov	Dec	Year
Speed	14.8	14.3	12.7	11.2	20.6	9.8	9.1	7.8	7.3	10.3	14.7	14.9	11.4
Most Frequent Direction	E	E	E	E	NW	NW	NW	NW	E	E	E	E	E
Maximum Hourly Speed	84 ^a	80	76	83	68	56	53	46	58	71	76	74	-
Direction Max. Hourly Speed	E	E	E	E	W	E	S	E	E	E	E	E	E
Maximum Gust Speed	113	119 ^b	111	103	84	77	72	83	78	101	111	113	-
Direction Maximum Gust	E	E	E	E	E	E	S	E	E	E	E	SW	E

^aAll-time extreme (1975/11)

^bAll-time extreme (1978/08)

Prince Rupert 54°17'N 130°26'W Active Station

Elevation: 34.4 m

Wind (km/h)	Jan	Feb	Mar	Apr	May	June	July	Aug	Sept	Oct	Nov	Dec	Year
Speed	14.3	14.7	14.5	14.5	12.9	11.3	9.6	9.6	10.8	14.5	14.7	15	13.1
Most Frequent Direction	SE	SE	SE	SE	SE	W	W	SE	SE	SE	SE	SE	SE
Maximum Hourly Speed	89	74	70	74	64	55	64	54	75	93 ^a	89	87	-
Direction Max. Hourly Speed	SE	S	SE	S	SE	SE	SE	S	S	SE	SE	SE	SE
Maximum Gust Speed	115	113	113	109	96	76	64	70	96	135	137 ^b	133	-
Direction Maximum Gust	SE	S	SE	S	SE	SE	SE	SE	S	SE	SE	SE	SE

^aAll-time extreme (1964/18)

^bAll-time extreme (1968/28)

Sandspit Airport 53°15'N 131°49'W Active Station

Elevation: 6.40 m

Wind (km/h)	Jan	Feb	Mar	Apr	May	June	July	Aug	Sept	Oct	Nov	Dec	Year
Speed	21.6	21.1	20	20.5	19.3	17.7	16.4	16	17.2	19.9	21.4	21.4	19.4
Most Frequent Direction	SE	SE	SE	SE	SE	SE	W	W	SE	SE	SE	SE	SE
Maximum Hourly Speed	129	105	100	113	97	77	74	74	93	137 ^a	121	121	-
Direction Max. Hourly Speed	-	-	-	-	-	-	-	-	-	-	-	-	-
Maximum Gust Speed	161	164 ^b	121	140	122	97	93	100	113	148	161	152	-
Direction Maximum Gust	SE	SE	SE	SE	E	SE	SE	E	SE	E	SW	SE	SE

^aAll-time extreme (1954/20)

^bAll-time extreme (1974/20)

Stewart Airport 55°56'N 129°59'W Active Station

Elevation: 7.30 m

Wind (km/h)	Jan	Feb	Mar	Apr	May	June	July	Aug	Sept	Oct	Nov	Dec	Year
Maximum Hourly Speed	41	48	57	48	46	46	39	35	33	48	46	50	-
Direction Max. Hourly Speed	S	N	S	S	S	S	S	S	S	SW	S	S	S
Maximum Gust Speed	61	61	50	54	65	50	39	56	46	63	65	74	-
Direction Maximum Gust	N	N	S	SW	S	S	N	S	SW	NW	S	SW	SW

Vancouver International Airport 49°12'N 123°10'W Active Station

Elevation: 4.30 m

Wind (km/h)	Jan	Feb	Mar	Apr	May	June	July	Aug	Sept	Oct	Nov	Dec	Year
Speed	11.5	12.1	12.9	12.6	12	11.7	11.5	11	10.6	11	12.3	12	11.8
Most Frequent Direction	E	E	E	E	E	E	E	E	E	E	E	E	E
Maximum Hourly Speed	69	89 ^a	77	72	61	52	48	50	64	76	89	82	-
Direction Max. Hourly Speed	SW	W	W	W	W	W	W	W	W	SE	W	SE	W
Maximum Gust Speed	97	119	108	100	90	70	71	85	91	126	129 ^b	100	-
Direction	SW	W	W	W	W	W	W	W	W	SE	W	SE	W

^aAll-time extreme (1960/20)

^bAll-time extreme (1957/25)

FREQUENCY OF FOG

Station	Observations		Percentage of observations when fog was present											
	Years	No. Per Day	Jan	Feb	Mar	Apr	May	June	July	Aug	Sept	Oct	Nov	Dec
Alert Bay 50°35'N 126°57'W	1954-81	6	3.2	2.6	2.3	2.2	2.7	5.0	7.7	14.1	13.4	8.0	3.9	3.9
Bull Harbour 50°55'N 127°56'W	1953-81	6	6.3	5.6	4.7	5.0	6.1	9.4	13.9	18.5	16.8	10.2	7.0	7.6
Campbell River 49°57'N 125°16'W	1979-81	16	20.1	35.7	6.6	7.4	6.6	3.2	3.2	4.4	14.6	24.8	29.4	35.5
Cape St. James 51°56'N 131°01'W	1953-80	24	22.3	24.1	16.8	16.1	14.9	18.6	21.5	20.5	23.3	26.3	19.5	24.3
Cape Scott 50°47'N 128°26'W	1966-81	8	12.3	11.1	11.8	10.6	12.3	14.7	19.3	24.7	20.0	17.7	13.4	14.4
Estevan Point 49°23'N 126°33'W	1953-79	14	22.5	21.5	16.2	11.1	10.3	12.8	14.8	21.4	18.4	23.6	18.9	22.4
Ethelda Bay 53°03'N 129°41'W	1957-80	4	12.3	13.8	11.4	9.2	9.8	10.8	12.3	14.7	16.6	20.0	14.0	14.3
Langara 54°15'N 133°03'W	1954-80	4	4.9	4.3	4.4	4.3	4.2	8.5	14.6	13.8	9.9	6.1	5.1	5.3
McInnes Island 52°16'N 128°43'W	1955-80	6	6.9	5.2	4.7	5.0	5.6	7.1	9.4	13.9	13.7	10.5	7.6	6.6
Merry Island 49°28'N 123°54'W	1954-79	11	4.7	3.8	1.0	0.3	0.1	0.2	0.4	0.4	3.1	6.5	5.0	2.7
Port Hardy 50°41'N 127°22'W	1953-81	24	6.5	4.8	3.8	3.0	2.8	5.0	7.1	13.3	17.2	12.1	7.8	6.8
Prince Rupert 54°17'N 130°23'W	1961-80	24	11.5	11.4	10.6	10.8	7.8	12.8	16.8	20.6	17.9	13.5	10.3	12.4
Sandspit 53°15'N 131°49'W	1953-80	24	9.4	10.8	7.4	6.2	5.4	6.2	5.4	5.4	8.2	12.7	12.2	11.2
Spring Island 50°00'N 127°25'W	1953-79	24	20.2	19.2	13.8	12.2	10.6	11.5	11.6	16.5	15.2	20.3	16.5	20.0
Tofino 49°05'N 125°46'W	1960-81	24	25.7	23.4	20.5	16.4	14.1	18.1	21.8	29.8	26.8	29.0	23.4	27.6
Triple Islands 54°18'N 130°53'W	1953-67	4	1.2	1.8	0.9	1.2	2.6	5.2	7.1	8.5	6.9	1.3	0.9	1.6
Vancouver Airport 49°11'N 123°10'W	1953-81	24	25.3	21.0	9.1	4.4	3.5	3.7	3.0	7.4	16.7	25.7	24.3	25.5
Vancouver Harbour 49°18'N 123°07'W	1976-81	14	37.1	24.1	13.0	7.8	7.5	7.6	3.8	7.6	13.0	20.9	18.8	20.8
Victoria 48°25'N 123°19'W	1953-81	24	11.0	9.2	3.4	2.8	1.9	2.6	2.6	5.4	12.7	17.4	13.4	10.8

BEAUFORT SCALE OF WIND FORCE

For an effective height of 10 m above sea level.

Beaufort Number	Wind Description	Deep Sea Criteria	Probable mean wave height in metres*	Mean wind speed equivalent in knots	Mean wind speed equivalent in m/sec
0	Calm	Flat calm, mirror smooth	-	<1	0-0.2
1	Light air	Small wavelets, without crests	0.1 (0.1)	1-3	0.3-0.5
2	Light breeze	Small wavelets, crests glassy but not breaking	0.2 (0.3)	4-6	1.6-3.3
3	Gentle breeze	Large wavelets, crests beginning to break	0.6 (1)	7-10	3.4-5.4
4	Moderate breeze	Small waves, becoming longer, crests breaking frequently	1 (1.5)	11-16	5.5-7.9
5	Fresh breeze	Moderate waves, longer with crests breaking	2 (2.5)	17-21	8.0-10.7
6	Strong breeze	Large waves, forming crests, breaking more frequently	3 (4)	22-27	10.8-13.8
7	Strong wind	Large waves, streaky foam	4 (5.5)	28-33	13.9-17.1
8	Gale	High waves, increasing in length, continuous streaking of crests	5.5 (7.5)	34-40	17.2-20.7
9	Strong gale	High waves, crests rolling over, dense streaking	7 (10)	41-47	20.8-24.4
10	Storm	Very high waves, overhanging crests, surface white with foam	9 (12.5)	48-55	24.5-28.4
11	Violent storm	Exceptionally high waves, surface completely covered with foam	11.5 (16)	56-63	28.5-32.6
12	Hurricane	Air filled with spray, visibility impaired	14 (-)	≥64	32.7 and over

This table is intended as a guide to show roughly what may be expected in the open sea, remote from land. It should never be used for logging or reporting sea state. In enclosed waters, or when near land, with an off-shore wind, wave heights will be smaller and the waves steeper.

*Figures in brackets indicate probable maximum height of waves.

FEDERAL AND PROVINCIAL POWERS FOR PROTECTING MARINE AREAS

Agency	Legislative Tools	Designations	Mandate
Fisheries and Oceans Canada (Federal)	<i>Oceans Act</i>	Marine Protected Areas	To protect and conserve: <ul style="list-style-type: none"> • fisheries and resources, including marine mammal and their habitats; • endangered or threatened species and their habitats; • unique habitats; • areas of high biodiversity or biological productivity; • areas for scientific and research purposes.
	<i>Fisheries Act</i>	Fishery closures	Conservation mandate to manage and regulate fisheries, conserve and protect fish, protect fish habitat and prevent pollution of waters frequented by fish.
Environment Canada (Federal)	<i>Canadian Wildlife Act</i>	National Wildlife Areas Marine Wildlife Areas	To protect and conserve marine areas that are nationally or internationally significant for all wildlife but focusing on migratory marine birds.
	<i>Migratory Birds Convention Act</i>	Migratory Bird Sanctuaries	To protect coastal and marine habitats which are heavily used by birds for breeding, feeding, migration and over-wintering.
Parks Canada (Federal)	<i>National Parks Act</i> Proposed National Marine Conservation Areas Act	National Parks Proposed Marine Conservation Areas	To protect and conserve for all time marine conservation areas of Canadian significance that are representative of the five National Marine Regions identified on the Pacific coast of Canada, and to encourage public understanding, appreciation and enjoyment.
Ministry of Environment (Provincial)	<i>Ecological Reserve Act</i>	Ecological Reserves	To protect: Representative examples of BC's marine environment; <ul style="list-style-type: none"> • rare, endangered or sensitive species or habitats; • unique, outstanding or special features; and • areas for scientific research and marine awareness.
	<i>Park Act</i>	Provincial Parks	To protect: <ul style="list-style-type: none"> • examples of marine diversity, recreational and cultural heritage; and • special natural, cultural heritage and recreational features. To serve a variety of outdoor recreation functions including: <ul style="list-style-type: none"> • enhancing major tourism travel routes; • providing attractions for outdoor holiday destinations.
	<i>Wildlife Act</i>	Wildlife Management Areas	To conserve and manage areas of importance to fish and wildlife and to protect endangered or threatened species and their habitats, whether resident or migratory, of regional, national or global significance.
	<i>Land Act</i>	Designated Wildlife Reserves	To reserve Crown land for specified periods for a variety of reasons, including the protection of sensitive habitat or habitat important for the conservation or well-being of species.
	<i>Environment and Land Use Act</i>	"Protected Areas"	To protect: <ul style="list-style-type: none"> • representative examples of marine diversity, recreational and cultural heritage; and • special natural, cultural heritage and recreational features.

Source: Marine Protected Areas: A Strategy for Canada's Pacific Coast (2000).

Metric Conversion Table

metres	feet	fathoms
0.1		
0.2		
0.3	1	
0.4		
0.5		
0.6	2	
0.7		
0.8		
0.9	3	
1.0	3.28	
1.1		
1.2	4	
1.3		
1.4		
1.5	5	
1.6		
1.7		
1.8	6	1
1.9		
2.0		
2.1	7	
2.2		
2.3		
2.4	8	
2.5		
2.6		
2.7	9	
2.8		
2.9		
3.0	10	
3.1		
3.2		
3.3		
3.4	11	
3.5		
3.6		
3.7	12	2
3.8		
3.9		
4.0	13	
4.1		
4.2		
4.3	14	
4.4		
4.5		
4.6	15	
4.7		
4.8		
4.9	16	
5.0		

metres	feet	fathoms
5.1		
5.2	17	
5.3		
5.4		
5.5	18	3
5.6		
5.7		
5.8	19	
5.9		
6.0		
6.1	20	
6.4	21	
6.7	22	
7.0	23	
7.3	24	4
7.6	25	
7.9	26	
8.2	27	
8.5	28	
8.8	29	
9.1	30	5
9.8	32	
10.4	34	
11.0	36	6
11.6	38	
12.2	40	
13.4	44	
14.6	48	8
15.8	52	
17.1	56	
18.3	60	10
21.3	70	
24.4	80	
27.4	90	15
36.6	120	20
45.7	150	25
50	164	
55	180	30
64	210	35
73	240	40
91	300	50
100	328	
110	360	75
150	492	82
183	600	100
200	656	
250	820	
274	900	150
366	1200	200
549	1800	300

- Aids to Navigation**, *C3/P1*
 Airborne liferaft, *C2/P128*
 Aircraft signals, *C2/P145*
 Air obstruction lights, *C3/P8*
 Air resources, *C2/P127*
 Air Transportation, *C1/P42*
 AMVER, *C2/P137*
 Aquaculture, *C2/P47*
 Area to be Avoided, *C1/P139*
 Automated Mutual-Assistance
 Vessel Rescue System, *C2/P137*
 Automatic Identification
 System (AIS), *C1/P130, C3/P72*
- Ballast water**, *C1/P136*
 Barges under tow, *C2/P64*
 Barkley Canyon, *C5/P4*
 Bathymetric maps, *C5/P18*
 Bell and Whistle Buoys, *C3/P27*
 Bottom culture, *C2/P51*
 Bowie Seamount, *C2/P2, C5/P10*
 Bridges, *C2/P87*
 British Columbia, *C1/P26*
 Buoy numbering, *C3/P19*
 Buoys, *C3/P12*
- Cables and pipelines**, *C2/P73*
 Calling-in points, *C1/P80*
 Campbell River, *C1/P190*
 Canada, *C1/P1*
 Canadian Aids to Navigation
 System, The, *C4/P88*
 CANPASS Ports of Entry, *C1/P117*
 CANPASS Presentation and
 Reporting, *C1/P108*
 CANPASS Private Boat
 Program, *C1/P105*
 CANPASS Responsibilities, *C1/P111*
 Cardinal buoys, *C3/P20*
 Cascadia Basin, *C5/P13*
 Catalogues of Nautical Charts and
 Publications, *C4/P16*
 Celestial Reef, *C5/P6*
 Cell Phone, *C1/P46*
 Cellular Telephone Marine Emergency
 Service #16, *C3/P52*
 Channel 9, *C3/P62*
 Chart 1 Symbols Abbreviations
 Terms, *C4/P17*
 Chart production, *C4/P71*
 Chart Reliability, *C4/P48*
 Charts and Nautical Publications
 Regulations, 1995, *C4/P1*
 Chart Source Data, *C4/P51*
 Chemainus, *C1/P191*
 CHS Publications, *C4, P1*
 Clayoquot Canyon, *C5/P4*
 Climate and weather
 conditions, *C5/P21*
 Coastal/Airport Watch
 Program, *C1/P122*
 Coast Mountains, *C5/P9*
 Cobb Seamount, *C2/P3, C5/P17*
 Cold Water Survival, *C2/P158*
 Commercial Fishing Methods, *C2/P29*
 Compulsory Pilotage Areas, *C1/P169*
 Constitution, *C1/P3*
- Contiguous Zone, *C1/P22*
 Continental Shelf, *C1/P24*
 Controlled Access Zones, *C1/P135*
 Co-operative Vessel Traffic System
 Agreement, *C1/P74*
 Cooperative Vessel Traffic
 Services (CVTS), *C1/P57*
 Coverage and factors affecting
 communications, *C3/P34*
 Cowichan Bay, *C1/P192*
 Crofton, *C1/P193*
 Crowther Canyon, *C5/P4*
 Currency, *C1/P17*
 Current Atlas, Juan de Fuca Strait to
 Strait of Georgia, *C4/P28*
 Customs reporting
 requirements, *C1/P89*
- Daybeacons**, *C3/P9*
 Deadhead, *C2/P70*
 De-ratting, *C1/P221*
 Dellwood Seamount Chain, *C5/P12*
 Dickins Seamount, *C5/P11*
 Differential GPS (DGPS), *C3/P96*
 Digital Data, *C4/P30*
 Digital Selective
 Calling (DSC), *C3/P49*
 Direction finding, *C3/P58*
 Distress message, *C2/P140*
 Dixon Entrance, *C5/P6*
 Driftwood, *C2/P67*
 Duncan Bay, *C1/P190*
- East Peak**, *C5/P14*
 Ecological Reserves, *C2/P117*
 El-Niño, *C5/P24*
 Emergency lights, *C3/P4*
 ENC Production, *C4/P77*
 Endeavour Seamount, *C5/P14*
 EPIRB, *C2/P149*
 Esperanza Canyon, *C5/P4*
 Esquimalt Harbour, *C1/P194*
 Exclusive Economic Zone, *C1/P23*
- Father Charles Canyon**, *C5/P4*
 Ferry routes, *C2/P58*
 Ferry service, *C1/P32*
 Fish farms, *C2/P49*
 Fishing boundary markers, *C2/P46*
 Fishing vessels, *C2/P24*
 Fog signals, *C3/P6*
 Fraser Port, *C1/P195*
 Fraser River Harbour, *C1/P195*
 Freighter traffic, *C2/P60*
 Frequency agile Racons, *C3/P82*
 Fuel availability, *C1/P213*
- Galileo**, *C3/P105*
 Gillnets, *C2/P32*
 Global Maritime Distress and Safety
 System (GMDSS), *C3/P44*
 Global Navigation Satellite
 Systems, *C3/P88*
 Global Positioning
 System (GPS), *C3/P89*
 Glonass, *C3/P103*
 Government of Canada, *C1/P4*
- GPS point positioning error
 sources, *C3/P99*
 Graham Island, *C1/P29*
- Haida Gwaii**, *C1/P28*
 Haida Ridge, *C5/P12*
 Harmac, *C1/P198*
 Hecate Strait, *C5/P8*
 Heckle Seamount, *C5/P15*
 Heckle Seamount Chain, *C5/P15*
 Heck Seamount, *C5/P14*
 Heck Seamount Chain, *C5/P14*
 Helicopter evacuation, *C2/P129, C2/P132*
 Herring roe on kelp, *C2/P54*
 Hodgkins Seamount, *C5/P11*
 Horizontal Datum, *C4/P31*
 How VTS Operates, *C1/P48*
 Hydrographic and Seismic Surveys,
 C2/P6
 Hypothermia, *C2/P162*
- INMARSAT**, *C3/P67*
 Inside Passage, *C1/P158*
 International charts, *C4/P80*
- Juan de Fuca Abyssal Plain**, *C5/P13*
 Juan de Fuca Canyon, *C5/P3*
 Juan de Fuca Ridge, *C5/P13*
- Kelp**, *C2/P99*
 Kitimat, *C1/P197*
 Kwakiutl Canyon, *C5/P4*
 Kyuquot Canyon, *C5/P4*
- Landmarks and conspicuous
 objects**, *C3/P30*
 La Pérouse Bank, *C5/P2*
 Lateral buoys, *C3/P15*
 Leadline, *C4/P51*
 Learmonth Bank, *C5/P6*
 Legal System, *C1/P11*
 Lights, *C3/P3*
 Light sectors, *C3/P5*
 Lights on Canadian Warships, *C2/P19*
 Limiting conditions 2 MHz
 band, *C3/P35*
 List of Lights, Buoys and
 Fog Signals, *C4/P82*
 Local magnetic anomalies, *C2/P92*
 Logbooms, *C2/P65*
 Longlining, *C2/P34*
 Loudoun Canyon, *C5/P4*
 Lowest Astronomical Tide, *C4/P44*
- Magnetic Anomalies**, *C2/P91*
 Magnetic compass and
 power cables, *C2/P84*
 Magnetic storms, *C2/P94*
 Magnetic variation, *C4/P79*
 Marina Frequency, *C3/P65*
 Marine Communications and Traffic
 Services (MCTS), *C3/P41*
 Marine farming, *C2/P47*
 Marine Protected Areas, *C2/P114*
 Marine Transportation Security
 Regulations, *C1/P123*
 Marine weather reports, *C3/P56*
 Maritime Zones, *C1/P20*

- Marking of fishing gear, *C2/P44*
MAYDAY, *C2/P140*
Message Markers, *C1/P78*
Metric and Imperial Unit
Charts, *C4/P47*
Migratory Bird Sanctuaries, *C2/P108*
Mild hypothermia, *C2/P164*
Military exercise areas, *C2/P11*
Moresby Island, *C1/P29*
Multibeam echosounders, *C4/P56*
Multipath, *C3/P101*
- NAD27**, *C4/P35*
NAD83, *C4/P38*
Nanaimo Harbour, *C1/P198*
Natural Environment and
Protected Areas, *C2/P99*
Nautical Charts, *C4, P31*
NAVTEX, *C3/P66*
New Chart, *C4/P4*
New Edition, *C4/P4*
New Westminster, *C1/P195*
Nitinat Canyon, *C5/P4*
Non-tidal Currents, *C5, P148*
Northern Resident Killer
Whales, *C2/P107.2*
North Fraser Harbour, *C1/P199*
Notices to Mariners, *C4/P7*
Notices to Mariners 1 to 46
Annual Edition, *C4/P84*
Notices to Mariners Monthly
Edition, *C4/P85*
Notices to Shipping, *C3/P55, C4/P87*
- Ocean Data Acquisition**
System (ODAS), *C3/P23*
Off-bottom culture, *C2/P52*
Official languages, *C1/P15*
Ououkinsh Canyon, *C5/P4*
Overhead cables, *C2/P79*
Oyster farms, *C2/P50*
- PAN PAN**, *C2/P141*
Participation in VTS Systems, *C1/P55*
Passing distance, *C2/P40*
Patrol vessels, *C2/P123*
Paul Revere Ridge, *C5/P12*
Pilotage, *C1/P167*
Pilot dispatch offices, *C1/P171*
Pisces Canyon, *C5/P4*
Police forces, *C1/P13*
Population, *C1/P16*
Port Alberni Harbour, *C1/P200*
Port Mellon, *C1/P202*
Ports of Entry, *C1/P116*
Powell River, *C1/P203*
Pre-Arrival Information
Report (PAIR), *C1/P129*
Precipitation, *C5/P43*
Preliminary Notices to
Mariners, *C4/P11*
Prince Rupert, *C1/P204*
Prince Rupert Traffic
Zone, *C1/P54, C1/P70*
Provincial governments, *C1/P8*
Puget Sound Pilots, *C1/P186*
Puget Sound Vessel Traffic
Service, *C1/P83*
Purse seine nets, *C2/P30*
- Quatsino Canyon**, *C5/P4*
- Radar beacons**, *C3/P80*
Radar ducting, *C3/P86*
Radar reflectors, *C2/P151, C3/P84*
Radio, *C1/P44, C3/P33*
Radio Aids to Marine
Navigation, *C4/P83*
Radiobeacons, *C3/P69*
Radio medical advice, *C3/P59*
Rail Transportation, *C1/P33*
Range marks, *C3/P11*
Raster ENCs, *C4/P12*
Recommended Code of Nautical
Procedures and Practices, *C4/P89*
Regional Marine Information
Centre, *C1/P85*
Regulations, *C1/P137*
Repairs, *C1/P216*
Reporting hazards, *C4/P67*
Reprint, *C4/P4*
Road Transportation, *C1/P37*
Royal Canadian Marine Search and
Rescue (RCM-SAR), *C2/P126*
- Safe Boating Guide**, *C4/P90*
Sailing Directions, *C4/P18*
Sail Plan, *C2/P136*
SAR craft, *C2/P124*
SARSAT, *C2/P147*
SART, *C2/P150*
Scott Seamount Chain, *C5/P12*
Sea, *C1/P31*
Sea and Swell, *C5/P157*
Seabed, *C5/P1*
Sea kayaking safety guide, *C4/P91*
Sea-plane landing areas, *C1/P43*
Seaplanes, *C2/P56*
Search and Rescue, *C2/P119*
Sea temperature, salinity
and density, *C5/P109*
Seattle Traffic Zone, *C1/P64*
Security zones around
vessels, *C1/P131*
Seminole Seamount, *C5/P12*
Ship-to-air distress signal, *C2/P142*
Ship to Ship Radio, *C3/P40*
Single-beam echosounders, *C4/P54*
Slow sweep Racons, *C3/P81*
Source Classification Diagram, *C4/P50*
- Southern Resident Killer
Whales, *C2/P107.1*
Special Purpose buoys, *C3/P22*
Special sound signals, *C2/P42*
Special visual signals, *C2/P41*
Spoil ground. Explosives, *C2/P20*
Sponge Reefs, *C2/P105*
Springfield Seamount, *C5/P16*
Squamish Harbour, *C1/P207*
Squamish winds, *C5/P38*
Stewart, *C1/P208*
Submarine cables, *C2/P73*
Submarine pipelines, *C2/P77*
Submarines, *C2/P17*
Swiftsure Bank, *C5/P2*
- Tanker Exclusion Zone (tez)**, *C1/P138*
Telephone, *C1/P45*
Temporary Notices to Mariners, *C4/P10*
Terrace, *C1/P40*
Territorial Governments, *C1/P10*
Territorial Sea, *C1/P21*
Tide and Current Information, *C5/P120*
Tide and Current Tables, *C4/P21*
Time signals, *C3/P60*
Traffic, *C2/P56*
Trawlers, *C2/P38*
Treatment of severe hypothermia, *C2/P167*
Trolling, *C2/P36*
Tsunami, *C5/P181*
- Unknown Datum**, *C4/P34*
Upstream direction, *C3/P17*
Urgency message, *C2/P141*
- Vancouver**, *C1/P209*
Vancouver Gap, *C5/P12*
Vancouver Island, *C1/P27*
Vancouver Traffic
Zone, *C1/P52, C1/P65*
Vector ENCs, *C4/P13*
Vertical Datum, *C4/P39*
Very High
Frequencies (VHF), *C3/P39*
Vessel Traffic Services (VTS), *C3/P43*
Vessel Traffic Services (VTS), *C1/P50*
Victoria Harbour, *C1/P212*
Visibility, *C5/P45*
- Waterway Watch Program**, *C1/P121*
Wave statistics, *C5/P157*
Weights and Measures, *C1/P19*
West Devil Rock, *C5/P6*
West Peak, *C5/P14*
Whale watching guidelines, *C2/P107*
Williams Lake, *C1/P39*
Williwaws, *C5/P40*
Winds, *C5/P32*
Woodfibre, *C1/P207*



Sailing Directions British Columbia Coast Index of Booklets



- PAC 201** Juan de Fuca Strait and Strait of Georgia
- PAC 202** Discovery Passage to Queen Charlotte Strait and West Coast of Vancouver Island
- PAC 205** Inner Passage — Queen Charlotte Sound to Chatham Sound
- PAC 206** Hecate Strait, Dixon Entrance, Portland Inlet and Adjacent Waters and Haida Gwaii
- PAC 200** General Information — Pacific Coast