



## Surveyor General Branch



# National Standards for the Survey of Canada Lands



**Version 1.2  
January 2022**

For information regarding reproduction rights, contact Natural Resources Canada at [nrcan.copyrightdroitdauteur.nrcan@canada.ca](mailto:nrcan.copyrightdroitdauteur.nrcan@canada.ca).

© Her Majesty the Queen in Right of Canada, as represented by the Minister of Natural Resources, 2022

Cat. No. M124-8/2022E-PDF (Online)  
ISBN 978-0-660-40960-3

*Aussi disponible en français sous le titre :*  
Normes nationales pour l'arpentage des terres du Canada



## **Note on this version**

This version 1.2 of the *National Standards for the Survey of Canada Lands* includes all published Addendum for the previous version of the National Standards (1.1), namely:

- **Addendum 1.6 - February 20, 2020**  
Object: Amendment to paragraph 19.b. of Section *1.6 Monumentation of Parcels and Boundaries*
- **Addendum 1.7 - February 20, 2020**  
Object: Amendment to paragraphs 5, 6, 12, 18 and 23 of *Appendix E: Digital Spatial File Specifications*
- **Addendum 1.8 - July 14, 2020**  
Object: Amendment to paragraph 1 of Section *2.7.1 Definition of Compiled Plan*, and paragraphs 5.1, 8 and 14 of Section *2.7.3 Plan Preparation*
- **Addendum 1.9 - February 1, 2021**  
Object: Addition of new Chapter *15: Mining Surveys - Nunavut*
- **Addendum 1.10 - February 1, 2021**  
Object: Amendment to the title, to paragraphs 1, 2 and 5 of Section *13.1 Introduction*, to paragraphs 6, 8, 12a., 15 and 22 of Section *13.2 Survey Methods*, to paragraph 37b. of Section *13.4 Plan Preparation*, to the specimen plan of Section *13.6 Specimen Plan*.
- **Addendum 1.11 - March 29, 2021**  
Object: Modify the whole of *Chapter 7: Building Unit Surveys*
- **Addendum 1.12 - June 29, 2021**  
Object: Incorporation of new tables of uncertainty, clarification on some of the items for Survey Reports and update information regarding names of regulations in *Chapter 11: Oil & Gas Surveys – NT, NU and Offshore*
- **Addendum 1.13 - January 1, 2022**  
Object: Modify the whole of *Chapter 6: Deferred Monumentation*



## Table of Contents

<b>Preface</b>	<b>v</b>
<b>Chapter 1: SURVEYS</b>	<b>1</b>
1.1 Introduction	1
1.2 Types of Monuments	1
1.3 Monument Markings	2
1.4 Ancillary Monumentation	2
1.5 Re-Establishment and Restoration of Monuments	3
1.6 Monumentation of Parcels and Boundaries	4
1.7 Line Cutting, Blazing, and Placement of Line Markers	6
1.8 Determination of Bearings	8
1.9 Geo-Referencing	8
1.10 Survey Accuracy	9
1.11 Survey Connections	10
1.12 Calibration of Measuring Equipment	10
<b>Chapter 2: SURVEY PLANS</b>	<b>11</b>
2.1 Introduction	11
2.2 Guidelines for Preparation of Survey Plans	13
2.3 Jurisdictional Boundary Survey Plans	21
2.4 Parcel Survey Plans	22
2.5 Highway, Railway, and Similar Right-of-Way Survey Plans	23
2.6 Resurvey Plans	25
2.7 Compiled Plans	26
2.8 Explanatory Plans	29
2.9 Administrative Area and Land Use Area Plans	31
<b>Chapter 3: FIELD NOTES</b>	<b>32</b>
3.1 Introduction	32
3.2 Information to be shown on Field Notes	32
3.3 Forms of Field Notes	33
3.4 Specimen Field Notes	33
<b>Chapter 4: SURVEY REPORTS</b>	<b>34</b>
4.1 When Is a Survey Report Required?	34
4.2 Content of Survey Reports	34
4.3 Processing of Survey Reports	35
<b>Chapter 5: WATER AND OTHER NATURAL BOUNDARIES</b>	<b>36</b>
5.1 Water Boundaries	36
5.2 Other Natural Boundaries	38



<b>Chapter 6: DEFERRED MONUMENTATION</b>	<b>39</b>
6.1 Definition of Deferred Monumentation	39
6.2 Use of Deferred Monumentation	39
6.3 Survey Methods	39
6.4 [Repealed]	40
6.5 Plan of Survey	40
6.6 [Repealed]	40
6.7 Field Notes of Final Placement of Monuments	40
6.8 Specimen Plans	41
<b>Chapter 7: BUILDING UNIT SURVEYS</b>	<b>42</b>
7.1 Definition of Building Unit Survey	42
7.2 Survey Methods	42
7.3 Plan Preparation	42
7.4 Title of Plan	43
7.5 Specimen Plans	44
<b>Chapter 8: CONDOMINIUM SURVEYS</b>	<b>45</b>
8.1 Introduction	45
8.2 Condominium Surveys in National Parks in Alberta	45
8.3 Condominium Surveys in NT, NU, and YT	46
8.4 Specimen Plans	48
<b>Chapter 9: AIR SPACE PARCEL SURVEYS</b>	<b>49</b>
9.1 Definition of Air Space Parcel Survey	49
9.2 Survey Methods	49
9.3 Plan Preparation	49
9.4 Title of Plan	50
9.5 Specimen Plan	50
<b>Chapter 10: OIL &amp; GAS SURVEYS ON FIRST NATION RESERVES</b>	<b>51</b>
10.1 Introduction	51
10.2 Survey Methods	51
10.3 Plan Preparation	52
10.4 Approvals and Certification	52
10.5 Survey Returns	52
10.6 Specimen Plans	53
<b>Chapter 11: OIL &amp; GAS SURVEYS – NT, NU, AND OFFSHORE</b>	<b>54</b>
11.1 Introduction	54
11.2 Establishing Grid Areas, Sections, and Units	55
11.3 Survey Methods	55
11.4 Plan Preparation	57
11.5 Survey Returns	59
11.6 Specimen Plans	59





<b>Chapter 12: OIL &amp; GAS SURVEYS – YT</b>	<b>60</b>
<b>Chapter 13: MINERAL CLAIM SURVEYS – NORTHWEST TERRITORIES</b>	<b>61</b>
13.1 Introduction	61
13.2 Survey Methods	62
13.3 Field Note Preparation	65
13.4 Plan Preparation	65
13.5 Survey Returns	66
13.6 Specimen Plan	66
<b>Chapter 14: MINING SURVEYS – YUKON</b>	<b>67</b>
14.1 Introduction	67
14.2 Claim Boundaries	67
14.3 Placer Mining Surveys	70
14.4 Quartz Mining Surveys	71
14.5 Field Note Preparation	73
14.6 Plan Preparation	74
14.7 Approvals and Certification	74
14.8 Survey Returns	75
14.9 Specimen Plans	76
<b>Chapter 15: MINING SURVEYS – NUNAVUT</b>	<b>80</b>
15.1 Introduction	80
15.2 Establishing Grid Areas, Sections and Units	80
15.3 Survey Methods	80
15.4 Plan Preparation	82
15.5 Survey Returns	83
15.6 Specimen Plans	83
<b>APPENDICES</b>	<b>84</b>
Appendix A: Glossary	84
Appendix B: Recommended Scales and Areas	88
Appendix C: Recommended Symbology	89
Appendix D: Abbreviations	91
Appendix E: Digital Spatial File Specifications	93



## Preface

*The National Standards for the Survey of Canada Lands* replaces the previous publication entitled *General Instructions for the Survey of Canada Lands*. It provides professional Canada Lands Surveyors with the technical standards that apply to surveys undertaken on Canada Lands, and constitutes the instructions of the Surveyor General for surveys of Canada Lands as specified in Section 24 (2) of the *Canada Lands Surveys Act*.

Canada lands are diverse, both geographically and administratively. Therefore it is a challenge to create common standards that meet the detailed requirements of all jurisdictions. The *National Standards* have been compiled to provide a common approach to boundary definition for all property rights systems (land registration and natural resource management regimes) and encourage the use of emerging technology throughout the Canada Lands Surveys System.

In recognition of the diverse needs of the property rights systems operating within the Canada Lands jurisdiction, the *National Standards* will be supported by *Regional Chapters* to address specific local requirements. Both the *National Standards* and the *Regional Chapters* are designed to be living documents with well-defined processes for maintenance that will involve all stakeholders including the land surveying community.

Content has been updated to provide current, comprehensible, and relevant *National Standards*. Redundant material in the previous publication has been removed, and some standards have been added or significantly revised, including those for geo-referencing, deferred monumentation, and water boundaries, to mention a few.

A Canada Lands Surveyor engaged to conduct a survey on Canada Lands must:

1. open a survey project in [MyCLSS](http://www.myclss.ca) ([www.myclss.ca](http://www.myclss.ca)) (My Canada Lands Survey System) before commencing the survey;
2. adhere to the *National Standards*; and
3. comply with any specific survey instructions issued by the Surveyor General for the project.

Information on the administrative requirements and procedures for surveys on Canada Lands is provided in [Getting a Survey Done](https://clss.nrcan-rncan.gc.ca/clss/surveystandards-normesdarcentage/gsd-frta) (<https://clss.nrcan-rncan.gc.ca/clss/surveystandards-normesdarcentage/gsd-frta>), a publication intended to assist those administering Canada Lands, including federal and territorial government departments and Aboriginal governments. It provides guidelines for arranging for surveys on Canada Lands and refers to the legislation that governs those surveys. Canada Lands Surveyors will also find that *Getting a Survey Done* contains invaluable information to support client consultation and help navigate the Canada Lands Surveys System.

The *National Standards* are a key component of the plan to position the Canada Lands Surveys System for the future and are designed to improve the efficiency and effectiveness of the System for all stakeholders.

Jean Gagnon  
Surveyor General of Canada Lands



## Chapter 1: SURVEYS

### 1.1 Introduction

- Chapter 1 of the National Standards provides standards that apply to all cadastral surveys of Canada Lands and private lands in the northern territories. Chapters 2 through 14 provide additional standards for certain categories of survey products. The Surveyor General may also provide additional specific survey instructions for certain surveys.
- If a common boundary separates the Canada Lands being surveyed from provincial lands, all applicable provincial laws and regulations pertaining to surveys must also be followed. If there is any conflict between federal and provincial survey requirements, consult the regional office of the Surveyor General Branch. Requirements that produce the higher standard of survey are generally to be followed.

### 1.2 Types of Monuments

- For surveys situated in the territories, use CLS 77 posts (see Figure 1 below) or CLS standard (capped) posts (see Figure 2 below) unless otherwise specified in the National Standards or in specific survey instructions. The minimum length of these posts must be 91.4 cm (36 inches) unless bedrock is encountered. In bedrock, drill a hole at least 7 cm long into the rock and cement a shorter rod for either post type into the hole. If the rod is shortened and cemented into rock, record the length of the post and record the post type as “CLS 77 rock post” or “CLS standard rock post.”

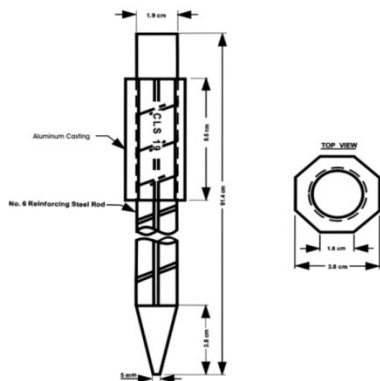

Figure 1 - CLS 77 Post

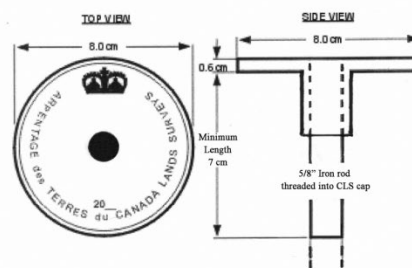

Figure 2 - CLS Standard Rock Post

- CLS 77 posts should protrude sufficiently for the marking to be readable unless the protrusion will create a safety hazard or render the posts subject to damage. Place CLS standard posts so that the top of the cap is flush with the adjacent surface.





6. Additional types of monuments or modifications to monuments may be approved or specified by the Surveyor General based on the nature of the ground, the terrain, safety concerns, and local custom.

### 1.3 Monument Markings

7. Mark CLS 77 posts and CLS standard posts with:
  - a. the letters “IR” for monuments on First Nation Reserve boundaries and “NP” for National Park boundaries;
  - b. the letters “R/W” or “R” on the side of the monument facing a right-of-way or road for monuments on right-of-way boundaries or roads;
  - c. lot numbers, bare land condominium unit numbers, and other parcel numbers;
  - d. a distinguishing number for monuments marking parcels and right-of-ways in rural and remote areas (e.g., 1L1000, 2L1000, ..., R25, R27, R28, etc.); and
  - e. the year of the survey.
8. Mark witness monuments with the letters “WT” followed by the distance and the approximate direction from the monument to the witnessed corner (e.g., WT 15 N).
9. In the provinces, mark monuments in accordance with the provincial practice unless otherwise specified in the National Standards or in specific survey instructions. This requirement includes using provincial markings for section and quarter section corners in DLS township surveys.

### 1.4 Ancillary Monumentation

10. The purpose of ancillary monumentation is to protect monuments from destruction and make them easier to find. Ancillary monumentation must accompany each placed monument unless conditions make this impracticable. Ancillary monumentation may include the following:
  - a. At each monument, place a wooden stake 5 cm square and 60 cm long approximately 0.3 m from the monument. This is suitable for townsites and subdivisions.
  - b. At each monument where public visibility is required (e.g., to protect monuments or mark jurisdictional boundaries), in lieu of a 5 cm square wooden stake, place a marker comprised of a T-section, angle, or similar type of fencing post or a flexible fibreglass reinforced composite marker. It must be at least 1.5 m long and placed, if possible, 0.3 m from the monument. Apply to the marker a decal or plaque with suitable markings and place the marker so that the decal or plaque faces the monument.
  - c. Considering the nature of the ground, the terrain, safety issues, and local custom, use other types of ancillary monumentation as appropriate (e.g., stone mounds, bearing trees, or other types of wooden stakes or wooden markers).



11. Record the type and the position of the ancillary monumentation used and a description of any decal or plaque applied to markers. It is sufficient to state where the ancillary monumentation is placed relative to the monuments, with only the exceptions noted. For bearing trees, record the type and the diameter of the tree, the distance and bearing from the monument to the blaze, and the markings placed on the blaze. Record the type of bearing (astronomic, grid, or magnetic). If the distance from the blaze to the monument is not measured horizontally, record the points from which it is measured (e.g., from the blaze to a point 1 m vertically above the post).
12. Do not place markers in traveled roads or trails or in any other place where they may create a safety hazard to people or vehicles, including off-road vehicles like quads and snowmobiles.

### 1.5 Re-Establishment and Restoration of Monuments

13. Most new surveys involve retracing previously surveyed boundaries and may require re-establishing and/or restoring monuments. In addition, surveyors carrying out other work, such as construction surveys, site surveys, and real property reports, may re-establish and/or restore monuments.
14. If the position of a lost or disturbed monument is re-established, and if it is used to place a new monument on a boundary dealt with by a survey, place new monumentation that meets current standards at the re-established position. In the case of a disturbed monument, the original monumentation may be used if it can be straightened or otherwise returned to its original position (see *Specimen Plan #7: Plan of Survey of Lots and Road and Utility Right-of-Way* (<https://clss.nrcan-rncan.gc.ca/clss/surveystandards-normesdarcentage/>)).
15. If the nature of the terrain or improvements make it impossible or inadvisable to re-establish a monument on a straight line boundary in its original position, and it is not necessary to place a witness monument because the position does not mark a parcel corner, place a new monument at a new location on the boundary in a secure location as close as practicable to the original position. Record the reason why the monument could not be re-established in the original position (See *Specimen Plan #9 Plan of Resurvey of Jurisdictional Boundary* (<https://clss.nrcan-rncan.gc.ca/clss/surveystandards-normesdarcentage/>)).
16. All obliterated monuments used in a survey must be restored. This requirement includes replacing the original monument with a similar monument or straightening the monument. Record the nature of the evidence found of the obliterated monument and what was done to restore it.
17. If the survey work carried out to re-establish or restore a monument is not shown on a survey plan, the work must be shown in field notes prepared in one of the forms prescribed in *Chapter 3: Field Notes* in the National Standards, and submitted for recording in the Canada Lands Survey Records (CLSR).



18. If the survey work is carried out to correct errors or supposed errors or to re-establish lost monuments, a plan of resurvey may be prepared for confirmation by the Surveyor General under Section 33 of the *Canada Lands Surveys Act*.

## 1.6 Monumentation of Parcels and Boundaries

19. Place monuments on all artificial boundaries being surveyed:
- at each change of direction of straight line boundaries;
  - at intervals not exceeding ten (10) kilometres for straight line boundaries;
  - at points of intersection with previously monumented boundaries except in the situations outlined in paragraph 20 below; and
  - at the beginning and end of curves, at points of changes of curvature, and at points where straight line boundaries intersect curves.
20. It is not necessary to place monuments at points of intersection with previously surveyed boundaries in the following situations:
- Where there is no tenure on an existing parcel or subdivision and it is not otherwise being used, or is not likely to be used, for any purpose, providing that:
    - the boundary of the parcel or subdivision is not part of a main survey fabric, such as a section line or concession line; and
    - sufficient connections are made to the parcel or subdivision to illustrate the relationship on the plan of survey.
  - Where in the resurvey of a jurisdictional boundary, such as the exterior boundary of a First Nation Reserve or National Park, monuments defining boundaries of parcels adjacent to the boundary purporting to be on the jurisdictional boundary are found off line. However, make connections to these monuments to illustrate their relationship to the jurisdictional boundary.
  - Where the boundaries intersect boundaries of subsurface parcels such as mineral claims. However, make sufficient connections to the boundaries of the subsurface parcel to illustrate the relationship on the plan of survey.
  - Where the boundaries intersect boundaries of non-exclusive interests that have been integrated with the survey fabric.
  - Where the boundaries intersect boundaries of wellsites and access roads surveyed in accordance with *Chapter 10: Oil & Gas Surveys on First Nation Reserves* in the National Standards.
21. For curved boundaries, to provide better boundary demarcation on the ground:
- It is preferable to use straight lines rather than curved lines for boundaries.
  - Do not create new spiral curve boundaries. If it is legally possible, substitute circular curves for existing spiral curves.



22. When surveying a right-of-way or road:
  - a. Only one limit of the right-of-way or road must be monumented unless the right-of-way or road is more than 30 m wide, in which case both limits must be monumented. The requirement to monument both limits may be relaxed by specific survey instructions if the right-of-way or road crosses large areas of vacant Crown land.
  - b. Where only one limit of a right-of-way is monumented, and a deflection point on that limit cannot be monumented or witnessed, monument the corresponding deflection point on the opposite limit. In addition, monument both limits at the previous or next deflection point.
23. If it is impossible or inadvisable to monument a point of deflection, a point of intersection, or a parcel corner (e.g., where the point falls in water), place a witness monument as near as practicable to the true location, preferably on one of the boundaries being surveyed. Only one witness monument can define a point, so do not place a witness monument if the corner is already defined by a witness monument. Record the distance and direction from the witness monument to the point of deflection or intersection, and the reason why the point could not be monumented.
24. Where it is inadvisable to place a witness monument for a parcel corner (e.g., in developed areas where buildings encroach on, or are contiguous with, the parcel boundary), the position of the corner may be defined by bearings and distances from adjacent monuments along the parcel boundaries. Record the reason why the corner could not be monumented, and make connections to the building or other entity.
25. Where an artificial boundary terminates at a water boundary, place a monument on the artificial boundary far enough from the water body so that it is reasonably safe from destruction. Measure and record to the nearest 0.1 m the distance along the artificial boundary from the monument to the water boundary.
26. When placing a new monument on an existing straight line or curved boundary, the new monument must be placed on the line or on the curve joining the two adjacent monuments marking the boundary. If the adjacent monuments are lost or disturbed, the closest best evidence must be used to re-establish the position of the adjacent monuments.
27. When a parcel is to be created beside an unsurveyed road, survey the limit of the road common to the lot, and place additional monuments on the road limit on both sides of the parcel at a sufficient distance to provide for any future extension of the road.
28. Remove monuments marking parcels being replaced by parcels of a new survey if they may cause confusion to the layperson and are of no value for an existing land interest or for future surveys. If the positions of the parcels being replaced are not connected to an existing survey, make connections to a sufficient number of monuments to ensure that the position of these parcels can be determined in the future if necessary.



## 1.7 Line Cutting, Blazing, and Placement of Line Markers

29. The main purpose of line cutting, blazing, and placement of line markers is to make boundaries identifiable on the ground. Well cut-out boundary lines and markers on boundary lines minimize the risk of boundary encroachments and disputes, support enforcement initiatives (e.g., detection of wildlife poaching), facilitate fencing, and reduce survey costs.

It is preferable that line cutting be carried out under the direction of the land surveyor at the time of survey to avoid misplaced cut lines and unnecessary cutting on private or Crown lands.

30. While it is preferable to have boundaries identifiable on the ground, consideration must also be given to environmental and economic factors. Line cutting may be prohibited in some jurisdictions or boundaries may already be fenced. Vegetation growth in some regions may be so rapid that cut lines would be obscured within a short period of time, making cutting uneconomical unless accompanied by fencing or some other form of demarcation.

In some cases, private land owners may have valid reasons for discouraging the cutting of boundaries. For example, trees may be used as a wind break, boundaries may parallel roads, or only certain boundaries may need to be cut.

31. Demark boundary lines with cut lines, blazing, and line markers placed on line as instructed in the following standards unless otherwise requested by the government department administering the land.
32. For privately owned lands (including First Nation Lands held under certificate of possession), before or when applying for specific survey instructions, a surveyor may submit a request, with the reason, for relief from obligations for line cutting, blazing, or the placement of line markers.
33. Before beginning any line-cutting work, it is the surveyor's responsibility to ensure that the requirements of any environmental assessment and review are followed. If these requirements conflict with any survey standard, consult the regional office of the Surveyor General Branch.
34. For jurisdictional boundaries, in addition to the requirements specified here, line cutting must be done in accordance with provincial or territorial government requirements.
35. Take all reasonable precautions to avoid causing damage to private property when cutting and blazing boundaries, and make every effort to inform each affected land owner and to accommodate any concerns.
36. Subject to environmental assessment and review, any government requirement, and any specific survey instruction:
- a. Cut out boundaries to make them recognizable as cut lines. Remove all fallen trees, logs, and brush from the cut line.





- b. Blaze suitable trees within 2 metres of each side of the boundary line. Blaze the side of the tree facing the boundary line and each side at right angles to this side. The blazed trees are not intended to mark the boundaries or the limits of the parcels; they are blazed to assist in finding the boundaries.
  - c. Line cutting and blazing are not required in developed townsites or subdivisions, for rights-of-way, or where boundaries follow features such as fences, hedges, or tree lines.
  - d. For parcel or lot and block surveys in undeveloped townsites or subdivisions, cut out parcel and block outlines. For lots within a block, it is not necessary to cut boundaries that are less than 40 metres long.
  - e. Do not cut out boundaries along travelled roads or cleared rights-of-way.
  - f. In the DLS township system, where road allowances are adjacent to First Nation Reserves or National Parks, the actual Reserve or Park boundary may not have been monumented or cut in the original survey. Any new monumentation marking the boundary must be placed on the actual boundary, and line cutting, blazing, and placement of line markers must be on the actual boundary. Line cutting or blazing is not necessary if a traveled road has been constructed in the road allowance or if the road allowance has been cleared.
  - g. Avoid cutting merchantable timber. Blaze merchantable trees left on a boundary with 3 blazes placed vertically (one above the other) on each side of the tree where the boundary line intersects the tree. Record the size and type of the tree and the distance from the nearest monument to the blaze.
37. If line markers are placed to help locate the position of boundaries, place them along the boundary lines at intervals of approximately 300 metres or at the distance specified in the specific survey instructions. They must consist of:
- a. flexible fiberglass reinforced composite markers or T-section, angle, or similar type of fencing posts at least 1.5 m long; or
  - b. any other object acceptable to the Surveyor General Branch.
38. Do not place line markers on traveled roads or trails or in any other place where they may create a safety hazard to people or vehicles, including off-road vehicles like all-terrain vehicles and snowmobiles.
39. Augment line markers on the boundaries of First Nation Lands or National Parks by applying an identification decal or plaque inscribed with suitable wording, such as *First Nation Reserve Boundary*, *First Nation Settlement Land Boundary*, or *National Park Boundary*.
40. Record which boundary lines have been cut and/or blazed, the boundary lines on which line markers have been placed, and a description of the decal or plaque applied to line markers.



## 1.8 Determination of Bearings

41. Derive bearings, in order of preference, from:
  - a. GNSS observations;
  - b. federal or provincial survey control monuments;
  - c. monuments established by a previous survey for which a plan is recorded in the CLSR; or
  - d. astronomic observations.
42. Where bearings are obtained from a closed traverse, the maximum allowable angular misclosure is  $20\sqrt{n}$  seconds, where “n” is the number of angles measured in the traverse loop or between lines of bearing control.

## 1.9 Geo-Referencing

43. Geo-referencing refers to the determination of the horizontal coordinates for a monument or point with respect to the North American Datum 1983 (Canadian Spatial Reference System) - NAD83 (CSRS) - or alternative horizontal datum if specified in the specific survey instructions.
44. A geo-referenced control point (GCP) is a monument (or, if necessary, a point related to a monument) that has been geo-referenced in accordance with the National Standards.
45. All surveys on Canada Lands must be geo-referenced unless otherwise specified in the National Standards or in specific survey instructions. Establish at least two GCPs, and more if they are required to achieve the accuracy standards specified in paragraphs 55 to 57 in *Section 1.10: Survey Accuracy* in the National Standards.
46. GCPs established in previous surveys may be used if the accuracy standards specified in paragraphs 55 to 57 in *Section 1.10: Survey Accuracy* can be achieved.
47. Control survey monuments of a provincial, federal, or other recognized survey control network may be used as GCPs, and so designated, provided that the surveyor can achieve the absolute accuracy standard specified in paragraph 49 below and the accuracy standards specified in paragraphs 55 to 57 in *Section 1.10: Survey Accuracy*.
48. A GCP must be physically marked on the ground. If a GCP is a point related to a monument, that point must be marked with a permanent object such as an iron bar or iron spike at least 20 cm long, a concrete nail in asphalt, or a copper or brass tack set in a lead plug in concrete. The top should be flush with, or slightly below, the adjacent surface.
49. All GCPs must have an absolute accuracy (see “accuracy, absolute” in *Appendix A: Glossary* in the National Standards) of +/- 0.10 metres or better at a 95% confidence level. Specific survey instructions may require a higher level of accuracy if the existing surveys in an area have been geo-referenced to a significantly higher level of accuracy.



50. Geo-referencing of GCPs must use one of the following methods:
- single point positioning solutions derived from the Precise Point Positioning (PPP) service of the Canadian Geodetic Survey, Natural Resources Canada (preferred method);
  - Global Navigation Satellite System (GNSS) measurement to Active Control points;
  - GNSS positions derived from Real Time Network corrections;
  - measurements to control survey monuments, including survey control monuments in former Coordinate Survey Areas if they have a published absolute accuracy of better than  $\pm 0.10$  metres at a 95% confidence level; or
  - any other method approved in specific survey instructions that complies with the National Standards for geo-referencing.

51. The version (epoch) of the NAD83 (CSRS) datum to be used for each province and territory can be found at this web address:

Link: [www.nrcan.gc.ca/maps-tools-publications/maps/adopted-nad83csrs-epochs/17908](http://www.nrcan.gc.ca/maps-tools-publications/maps/adopted-nad83csrs-epochs/17908)

52. In addition to recording the horizontal coordinates, record the ellipsoid height of each GCP and submit this data with the digital spatial file.

53. A surveyor who cannot meet the absolute accuracy requirements for geo-referencing may seek relief from this requirement by requesting an amendment to the specific survey instructions and providing the reason. The surveyor will be required to report on the estimated absolute accuracy achieved and why the accuracy standard could not be met.

54. Connections to GCPs are not required for new surveys that are within the lands dealt with by previous surveys that have been geo-referenced to the absolute accuracy requirements specified in paragraph 55 in *Section 1.10: Survey Accuracy* in the National Standards.

In specific survey instructions, the Surveyor General may relax the requirement to geo-reference certain surveys, such as those on lands that are contiguous with lands or boundaries dealt with by a previous survey that has been geo-referenced.

### 1.10 Survey Accuracy

55. The absolute accuracy of any monument defining a boundary in a survey, the position of which is derived from GCPs, must be  $\pm 0.20$  metres or better at a 95% confidence level.

56. The minimum relative accuracy standard for surveys based on the surveyor's own work is  $\pm 0.02$  metres plus 80 parts per million (ppm) at a 95% confidence level (see "accuracy, relative" in *Appendix A: Glossary* in the National Standards).

57. The minimum relative accuracy standard for surveys based on the surveyor's own work in combination with any other surveyor's recorded measurements is  $\pm 0.02$  metres plus 160 parts per million (ppm) at a 95% confidence level.



58. If the relative accuracy requirements cannot be met because of topographical constraints or for other reasons, the surveyor may submit a request, with the reason, for relief from the requirements. The surveyor will be required to report on the estimated relative accuracy achieved and why the accuracy standard could not be met.

### 1.11 Survey Connections

59. Connect all surveys to one, and preferably two, monuments of the closest existing survey if the existing survey lies within 300 metres of the new survey. (Specific survey instructions may exempt connections between the new survey and a nearby existing survey in cases where both the new survey and the nearby existing survey are accurately geo-referenced.)
60. Connect to the monument and/or boundary all structures, fences, hedges, and similar features that are close to a monument or that are close to or extend over a boundary being surveyed. These connections are required to preserve and illustrate evidence of the monument or boundary location, to show encroachments, and/or to provide locations of physical features that can be used to locate or assist in re-establishing a monument if it is lost.

### 1.12 Calibration of Measuring Equipment

61. All equipment used in the survey must be calibrated to a reliable measure of distance or position. The surveyor must keep records of calibration results and carry out sufficient analysis of the data to prove that the equipment is calibrated correctly and operating in accordance with the manufacturer's specifications.
62. Retain records of calibration results and copies of any analysis carried out so that they can be submitted as part of the survey returns if requested or at a later date if required.



## Chapter 2: SURVEY PLANS

### 2.1 Introduction

#### 2.1.1 Purpose of Survey Plans

1. Survey plans in the Canada Lands Survey System define boundaries and parcels of land on Canada Lands, both on land and in Canada's offshore, as required by the various property rights systems applying to these lands.

The plans are confirmed under the *Canada Lands Surveys Act* or are approved, and are then recorded in the Canada Lands Survey Records (CLSR).

Once recorded—or, in the case of titled land, filed, deposited, or registered in a land titles office—survey plans can be referenced in legal land descriptions. As a general rule, in order to have effect, the boundaries or parcels shown on a survey plan must be referenced in legislation or in an instrument such as an order-in-council, land transfer, certificate of title, deed, lease, or easement.

#### 2.1.2 Confirmed Plans Under Section 29 (Official Plans)

2. Under Section 29 (3) of the *Canada Lands Surveys Act*, the Surveyor General confirms a survey plan of Canada Lands if the survey was carried out in compliance with the Act and the survey and plan are satisfactory to the minister of the Government of Canada department or the Territorial Commissioner administering the Canada Lands on which the survey was carried out.
3. Once confirmed by the Surveyor General, a survey plan is deemed to be an Official Plan under the *Canada Lands Surveys Act*, and boundaries defined by the monuments shown on the Official Plan become the true boundary lines (see Sections 29 and 32 of the Act). In addition, Official Plans of Canada Lands resurveyed under Section 33 of the Act are substituted for all, or corresponding portions of all, former Official Plans of the lands.
4. Confirmation is generally used for jurisdictional boundaries (see *Section 2.3: Jurisdictional Boundary Survey Plans* in the National Standards), and when required by specific legislation (e.g., bringing land under the NT, NU, or YT *Land Titles Act* and for leases under the National Parks of Canada *Lease and Licence of Occupation Regulations*, the *Cree-Naskapi Land Registry Regulations*, or the *Westbank First Nation Land Registry Regulations*).
5. Survey plans of parcels of land that have boundaries contiguous with jurisdictional boundaries are not normally confirmed. Monuments placed for a parcel contiguous with a jurisdictional boundary will not affect the original position of the jurisdictional boundary.
6. The Surveyor General sends copies of confirmed survey plans for filing to the registrar of deeds or land titles of the county, district, or other registration division in which the lands are situated.





### 2.1.3 Approved Plans Under Section 31 (Administrative Plans)

7. Under Section 31 of the *Canada Lands Surveys Act*, the Surveyor General may make Administrative Plans for public lands for administrative purposes. These plans do not require confirmation and need not be sent to registry or land titles offices. If they will be used for defining boundaries or parcels, they are approved by the Surveyor General before being recorded in the CLSR.
8. Certain other legislation contains provisions for the Surveyor General to approve, review, or advise on the suitability of survey plans of Canada Lands, including the *Indian Oil and Gas Regulations*, the *Northwest Territories Mining Regulations*, the *Nunavut Mining Regulations*, the *Quartz Mining Act (YT)*, the *Placer Mining Act (YT)*, the *Northwest Territories Oil and Gas Land Regulations* and the *Canada Oil and Gas Land Regulations*.

### 2.1.4 Plans of Canada Lands for First Nation Lands Held Under Title

9. Certain First Nation Lands that are Canada Lands pursuant to Section 24 (1) of the *Canada Lands Surveys Act* are owned (held under title) and administered by First Nations.
10. Pursuant to Section 24 (2) of the *Canada Lands Surveys Act*, surveys of Canada Lands must be made in accordance with the instructions of the Surveyor General. However, for land held under title and owned and administered by a First Nation:
  - a. Section 29 of the Act does not apply because the lands are not administered by a minister of a Government of Canada department or by a Territorial Commissioner; and
  - b. Section 31 of the Act does not apply because they are not public lands.
11. Plans of these lands are prepared under Section 24 (2) of the Act and are “Approved for Recording in the Canada Lands Survey Records.”

### 2.1.5 Plans of Survey for Lands That Are Not Canada Lands

12. The Surveyor General has legislated obligations with respect to certain surveys and plans of survey for lands that are not Canada Lands. For example, certain legislation requires that a survey comply with the instructions of the Surveyor General, that the Surveyor General issue survey instructions, or that the Surveyor General approve survey plans of lands that are not Canada Lands.

This legislation includes land titles legislation in the territories, the *Condominium Act* in Yukon, and the *Dominion Water Power Act* and *Dominion Water Power Regulations* (see the *Dominion Water Power Act* for the specific lands covered by that Act, which generally applies to public lands belonging to Her Majesty in right of Canada).

Approvals of these plans of survey should refer to the section of the specific Act or Regulations that obligates the Surveyor General.

13. Under Section 47 of the *Canada Lands Surveys Act*, the Surveyor General may make surveys of any lands belonging to Her Majesty in right of Canada or of which the Government of Canada has the power to dispose. These surveys are normally carried



out under provincial legislation, and are only “Approved for Recording in the Canada Lands Survey Records.”

14. It is administratively convenient to record plans of surveys carried out under provincial legislation of lands for which the administration and control has been or is to be transferred to Canada (e.g., new National Parks, Additions to Reserves, Treaty Land Entitlements). These are only “Approved for Recording in the Canada Lands Survey Records.”

#### 2.1.6 Responsibility of Canada Lands Surveyor

15. The Surveyor General’s confirmation or approval of plans in no way diminishes the Canada Lands Surveyor’s obligation with regard to any matter to which the surveyor’s statement of responsibility on the plan applies (see Section 38 of the *Canada Lands Surveyors Regulations*).

## 2.2 Guidelines for Preparation of Survey Plans

### 2.2.1 Introduction

1. These guidelines apply to the preparation of all types of plans of survey of Canada Lands including the mandatory preparation of a digital spatial file as specified in appendix E.
2. In some cases, these guidelines may be superseded by specific survey instructions and/or other standards that specify additional requirements for a particular type of survey or plan, including endorsement and signature blocks.
3. Links to specimen plans are provided throughout the National Standards as guidance for the preparation of plans of survey of Canada Lands.
4. Field note information that must be filed with the Surveyor General under Section 18 of the *Canada Lands Surveys Act* is included in plans of survey, and it is understood that using the term “Plan of Survey of” in plan headings encompasses the term “field notes.” Additional or supplementary field notes may also be filed with the Surveyor General.
5. A plan that defines boundaries or parcels must clearly document the nature and position of the boundaries dealt with by the survey.

### 2.2.2 Format

6. Plans should be well-organized and uncluttered.
  - 6.1 For digital plans, the file must be in the PDF/A-1b or PDF/A-2b format which supports the use of secure electronic signature.
  - 6.2 For digital plans, the signature block must be aligned horizontally when opening the PDF file (any other alignment in the PDF file will not be accepted).
7. Draw plans to a scale sufficient to ensure clarity, referring to Table 1 in *Appendix B: Recommended Scales and Areas* in the National Standards for suggested scales.



8. Subject to any specific requirement of a land titles or land registry office, the size of plans, including margins, must not exceed 90 cm by 300 cm unless otherwise authorized by specific survey instructions.
9. Leave a margin of 2 cm outside the borders of the plan.
- 9.1 For digital plans, the PDF file shall have a minimum of 2 cm and a maximum of 5 cm of whitespace outside the borders of the plans.
10. Use lettering that is at least 2 mm high.
11. Draft lettering heights, line widths, scale bars, etc. so that they are true to scale for the plan image when it is viewed at the intended plot size. The plot size is the size of the paper on which the plan (including the 2 cm margin outside the plan borders) would need to be plotted to provide optimum readability.

### 2.2.3 Title Block

12. Provide in the title of the plan a description of the location, including:
  - a. the name of the boundary or the parcel designators;
  - b. if applicable, the name of the subdivision, township, community and/or municipality (city, town, village, etc.) in which the survey is located;
  - c. if applicable, the name of the Indian Reserve, National Park, etc.;
  - d. if applicable, the section, township, and range, or lot and concession, or quad;
  - e. if applicable, the district or county; and
  - f. the province or territory.
13. Include a scale ratio and a bar scale with this statement:

*The plot size that will provide true scale and optimum readability for this plan is \_\_\_\_\_ by \_\_\_\_\_ (plot size).*
14. Include the date of the field survey and the name and qualifications of the surveyor in this form:

*This survey was executed during the period of \_\_\_\_\_ (date) to \_\_\_\_\_ (date) by \_\_\_\_\_, CLS.*
15. If one or more parcels shown on a previous plan are to be replaced with one or more parcels shown on a new plan, add a prominent note in this form:

*Parcel(s) \_\_\_\_\_ dealt with by this plan replace(s) parcel(s) (or part(s) of parcel(s)) \_\_\_\_\_ dealt with by Plan(s) \_\_\_\_\_.*
16. Include a legend containing:
  - a. a statement for bearings in this form:

*Bearings are grid derived from \_\_\_\_\_ (bearing derivation method) and are referred to the central meridian of UTM [or MTM] Zone \_\_\_\_\_ (number);*



- b. an explanation of all symbols used that are not shown in *Appendix C: Recommended Symbology* in the *National Standards*; and
  - c. an explanation of all abbreviations used that are not listed in Table 1 in *Appendix D: Abbreviations* in the *National Standards*.
17. Include the following statements:
- a. For distances, include a statement indicating the unit of measurement and the scale factor to convert to grid. For example:  
*This plan shows horizontal ground level distances in metres [if applicable, insert “unless otherwise specified”]. To compute grid distances, multiply ground level distances by the average combined scale factor of \_\_\_\_\_ (factor).*
  - b. If not shown on the body of the plan, include a general statement describing the markings applied to monuments placed in the survey (if a commission number is marked on monuments, include in the statement the name of the association that issued the commission number).
  - c. If not shown on the body of the plan, include a statement describing the type and position of ancillary monumentation and a description of the decal or plaque applied to markers. It is sufficient to make a general statement and note any exceptions.
  - d. If not shown on the body of the plan, include a statement describing which boundary lines have been cut and/or blazed and which boundary lines have had line markers placed on them (with a description of the decal or plaque applied to the line markers).
  - e. If field notes and/or a survey report have been submitted for recording, include this statement:  
*Field notes (and/or a survey report) for this survey have been recorded under Field Book number \_\_\_\_\_ CLSR.*
18. The surveyor must provide on the plan a statement of responsibility in accordance with Section 38 of the *Canada Lands Surveyors Regulations*.
- If this statement is not in the form “Certified Correct,” the surveyor must consult the Surveyor General to determine whether or not the proposed alternative statement meets the Surveyor General’s requirements under Section 17 of the *Canada Lands Surveys Act*.



## 2.2.4 Diagram

### **General**

19. Orient the diagram portion of the plan so that North points towards the top of the plan.
20. Unless otherwise indicated in specific survey instructions, express areas and distances in metric units, and quote areas in accordance with the precision listed in Table 2 in *Appendix B: Recommended Scales and Areas* in the *National Standards*.
21. Express all bearings as full circle bearings in degrees, minutes, and seconds.
22. It is permissible to show diagram information in tables, details, or insets where this is necessary for clarity.
23. If the location of a survey is not easily discernible from the diagram of the plan, add a key plan at a reduced scale depicting the general location of the survey relative to the exterior boundaries of the Indian Reserve, National Park, or other jurisdictional area, and relative to surrounding topographic features.
24. Orient the key plan and details in the same general direction as the diagram of the plan.
25. Where the boundary of a surveyed parcel is contiguous with the limit of an unsurveyed road, show on the plan the road limit and the monuments placed on it on both sides of the parcel. Show on the plan only that the parcel is “dealt with” and do not refer to the road as surveyed in the title of the plan.

### **Boundaries, Dimensions and Labels**

26. Show a heavy black line (0.8 mm to 1.0 mm wide) coinciding with the exterior boundaries of the lands dealt with by the plan or, for a boundary survey, coinciding with the boundary.
27. Show the grid bearing and ground distance of each straight line boundary dealt with by the plan.
28. Show distances and bearings along the boundary lines to the monuments used to create or re-establish boundaries dealt with by the plan.
29. For each circular curve boundary, show the radius, the arc length, and the chord distance and bearing. If the curve is non-tangential, show also the radial bearing at the beginning and the end of the curve.
30. Where they are fundamental to the survey, show bearings and distances of traverse courses, offset lines, and radial ties.
31. Show the area of each parcel, road, or right-of-way dealt with by the plan. For roads within subdivisions, show only the total area for the roads, provided that this is acceptable to the land titles or land registry office.
32. Show the width of each road, right-of-way, or easement dealt with by the plan.





33. Show the designation of each new parcel, lot, block, road, or right-of-way dealt with by the plan.
34. Show the location, designation, and plan number of each parcel, block, easement, or road right-of-way within or adjoining the lands or boundaries dealt with by the plan.
35. If parcels are subdivided or consolidated, show in phantom their boundaries, their designations, and their CLSR plan numbers. If the parcels are dealt with on plans that are not recorded in the CLSR, provide details regarding the information source. It is necessary to show only the last generation of underlying parcels.
36. Show the nature and position of all significant natural and man-made features that are close to or extending over the boundaries of the lands being surveyed. Other features within or outside the lands being surveyed may also be shown.

For plans of surveys in Yukon, use a dashed line to show all water bodies within the lands dealt with, and include a statement in the title block describing how the water bodies were plotted and what information was used if it is not evident on the plan diagram.

37. Show the location and description of any other interests that are within the lands dealt with that are described in registered instruments or other documents affecting the land, the location of which is not shown on a recorded survey plan.
38. Show names of features according to the *Canadian Geographical Names Data Base*, published government maps, or local usage.

Link: [Canadian Geographical Names Data Base](http://www4.rncan.gc.ca/search-place-names/search?lang=en)

(<http://www4.rncan.gc.ca/search-place-names/search?lang=en>)

39. For First Nation Lands for which the plan will be used to register an interest in the Indian Land Registry, show access to each parcel. If showing access is not possible or access is not evident, add an explanatory note to the plan.
40. In the Northwest Territories or Nunavut, where a Crown-administered parcel being surveyed borders on a body of water, show within that parcel a dashed, labelled line 30.48 metres from the boundary of the water body.

### ***Monuments and Ancillary Monuments***

41. Show all evidence searched for or placed, indicating what was found, restored, and placed.
42. Show descriptions of the types, condition, and markings of all monuments used in the survey and of ancillary monumentation.
43. For bearing trees, describe the type and diameter of the tree, the distance and bearing from the monument to the blaze, and the markings placed on the blaze. State the type of bearing (astronomic, grid, or magnetic).



State the horizontal distance from the blaze to the monument if it is measured horizontally. If it is not measured horizontally, specify the point from which it is measured (e.g., from the blaze to a point 1 m vertically above the post).

The type of bearing and the nature of the distances from blazes to monuments may be stated in the legend.

44. Show the type, position, and identification number of any monument, GCP, or other control survey monument to which a surveyed connection has been made.

### ***Geo-Referencing***

45. In the diagram of the plan, show and designate all GCPs and any other control points used in the survey.
46. If a GCP is a point related to a monument in the diagram of the plan, show the connection from the GCP to the monument.
47. Include on the plan (a table may be used) the coordinates of all GCPs and any other control survey monuments used in the survey, together with the following information:
  - a. the coordinate system/map projection: NAD83 (CSRS)/UTM, NAD83 (CSRS)/MTM, or NAD83 (CSRS)/Double Stereographic projection, or an alternative coordinate system / map projection specified in the specific survey instructions;
  - b. the zone of the coordinate system;
  - c. the combined scale factor for each GCP and control survey monument or one combined scaled factor if one was used for the entire survey;
  - d. the estimated absolute accuracy of GCPs in the survey at a 95% confidence level;
  - e. the version (epoch) of the NAD83 (CSRS) datum used; and
  - f. a statement regarding how the coordinates were obtained and how any adjustment was performed.
48. If required for clarity, include a key plan showing the location of GCPs.

### **2.2.5 Remainders and Designation of Remainders**

49. The term “remainder” is used for the remaining part of a parcel (called the parent parcel) after a surveyed parcel has been taken out of it.
50. How a remainder is handled is dictated by the requirements of the government body administering the land or the land titles or land registry office in which the survey plan will be registered or filed. If a remainder is not surveyed during the course of the survey, it may be designated as follows:
  - a. with the parcel number of the parent parcel followed by the term “Remainder” or the abbreviation “Rem.” (e.g., 17 Rem.).

Boundaries of remainders designated in this manner must be shown on the plan but not shown as “dealt with.” Monuments are not shown unless found, nor are



bearings and distances shown unless measured during the course of the survey;  
or

- b. with a new parcel number.

If a remainder is to be designated with a new parcel number, it must be in one of three ways:

- i. prepare separate field notes of the survey of the surveyed parcel (see *Chapter 3: Field Notes* in the National Standards) and prepare a compiled plan incorporating the parcel and the remaining part of the parent parcel (see *Section 2.7: Compiled Plans* in the National Standards);
- ii. prepare a separate plan of survey of the surveyed parcel and a compiled plan of the remaining part of the parent parcel (see *Section 2.7: Compiled Plans* in the National Standards); or
- iii. prepare a compiled plan and field note product that compiles all of the subject parcels from previous field notes recorded in the CLSR and from field notes of any newly surveyed or retraced boundaries. (See *Section 2.7*)

#### 2.2.6 Endorsements and Affidavits

- 51. Place the appropriate endorsement certificates in the spaces shown on the specimen plans referenced in the National Standards.
- 52. MyCLSS will provide the wording and required signatories' endorsement certificates and affidavits. In the territories, refer to the appropriate territorial legislation for the required owners' and surveyor's affidavits.

#### 2.2.7 Media

- 53. The term "media" in the National Standards refers to the means of communicating survey information.

Over time, hardcopy media for plans (on polyester film) will gradually be replaced by digital media that are created and stored in digital form and transmitted electronically.

##### ***Hardcopy Media***

- 54. Prepare plans on polyester film (matte both sides), 0.05 mm to 0.10 mm thick.
- 55. Use black permanent ink. Do not use 'grey scale' settings.
- 56. Never use stick-on material to amend or add information to a plan.
- 57. Except for signatures, information shown on a plan may be produced thereon using digital techniques.
- 58. For signatures, the name and title of the person signing must be printed within the affidavit or certification, or below the signature.



***Digital Media***

59. Survey plans can be submitted as digital files that must meet specific requirements to ensure their authenticity and long-term preservation.
60. Digital media shall conform to the PDF/A-1b or PDF/A-2b format.
61. Digital media must be digitally signed using a secure electronic signature



## 2.3 Jurisdictional Boundary Survey Plans

### 2.3.1 Definition of Jurisdictional Boundary

1. A jurisdictional boundary is a boundary between two domains that have separate jurisdictions over land administration. For surveys of Canada Lands, jurisdictional boundaries include the boundaries of Indian Reserves, National Parks, and Settlement Lands in the territories.

The boundary of a road vested in a province through an Indian Reserve or National Park is a jurisdictional boundary (see *Section 2.5: Highway, Railway, and Similar Right-of-Way Survey Plans* in the National Standards).

### 2.3.2 Plan Preparation

2. See *Section 2.2: Guidelines for Preparation of Survey Plans* in the National Standards.

### 2.3.3 Title of Plan

3. Use this form for the title of a jurisdictional boundary survey plan:

*Plan of Survey of the [or describe the Part of the] Exterior Boundary of*  
\_\_\_\_\_ *(name of Canada Lands)*

4. For situations in which road surveys form jurisdictional boundaries, see *Section 2.5: Highway, Railway, and Similar Right-of-Way Survey Plans* in the National Standards.

### 2.3.4 Specimen Plans

*Links:*

[#1 Plan of Survey of Jurisdictional Boundary, South of 60](#)

[#1A Plan of Survey of Jurisdictional Boundary, South of 60 \(Digitally Signed\)](#)

[#2 Plan of Survey of Jurisdictional Boundary, North of 60](#)

[#3 Plan of Survey of Jurisdictional Boundary, National Park - Bilingual](#)

[\*\(https://clss.nrcan-rncan.gc.ca/clss/surveystandards-normesdarcentage/\)\*](https://clss.nrcan-rncan.gc.ca/clss/surveystandards-normesdarcentage/)



## 2.4 Parcel Survey Plans

### 2.4.1 Definition of Parcel Survey

1. A parcel survey is the survey of an area of land for the purpose of defining the extent of land tenure or some other exclusive use of the land, such as a long-term lease.
2. *Section 2.4: Parcel Survey Plans* in the National Standards does not address all parcel surveys. For example, highways, railway rights-of-way, building units, condominium units, and air space parcels are explained elsewhere in the National Standards.

### 2.4.2 Plan Preparation

3. See *Section 2.2: Guidelines for Preparation of Survey Plans* in the National Standards.

### 2.4.3 Title of Plan

4. The title of a plan of survey of parcels or lots usually lists the numbers or other designations of the parcels or lots created by the survey. The term subdivision survey is not normally used unless required by territorial or other legislation applying to the land titles or land registry office in which the plan will be registered or recorded.

5. Use one of these forms for the title of a plan of a parcel and/or lot survey:

*Plan of Survey of Lots 1 to 77 and Road*

*Plan of Survey of Lots 1 to 77 and 78 (Road) [if a parcel number is required for roads]*

*Plan of Survey of Parcel D*

*Plan of Survey of Lot 1000, Quad 105C/02 near Teslin, Yukon*

### 2.4.4 Specimen Plans

Links:

[#4 Plan of Survey of Parcel and Road](#)

[#6 Plan of Survey of Lots and Road](#)

[#7 Plan of Survey of Lots and Road and Utility Right-of-Way](#)

(<https://clss.nrcan-rncan.gc.ca/clss/surveystandards-normesdarcentage/>)





## 2.5 Highway, Railway, and Similar Right-of-Way Survey Plans

### 2.5.1 Definition of Right-of-Way

1. A right-of-way is a parcel, corridor, or other physical tract of land used for the passage of people, vehicles, or materials such as oil and gas, electricity, telecommunications, or water. The interest in the right-of-way may be exclusive or non-exclusive.

### 2.5.2 Right-of-Way Survey Defining Exclusive or Non-Exclusive Use

2. Section 2.5 in the National Standards deals with surveys of rights-of-way undertaken to define an interest of an exclusive nature (e.g., public highways, railways, irrigation canals). Section 2.5 may also be used for a non-exclusive use right-of-way that crosses a large, unsurveyed area (more than 1 kilometre), or if the boundaries of the right-of-way cannot easily be related to existing surveyed boundaries or monuments (e.g., electric power lines, telecommunication lines, and oil and gas pipelines).

*Chapter 1: Surveys* in the National Standards applies to these surveys.

3. An explanatory plan should be used for non-exclusive interests where the boundaries can be related to existing surveyed boundaries or monuments (see *Section 2.8: Explanatory Plans* in the National Standards).

A non-exclusive interest is a right to pass over the land of another or to use the land of another to transport material (e.g., the right to pass over another's land to access property or the right to place and maintain utility lines on private property). Such rights do not cause a severance of the parcel(s) in which they lie, normally do not interfere with the land owner's use of the land, and may be obtained in several ways (e.g., by legislation, right-of-way agreement, or easement).

### 2.5.3 Right-of-Way Survey Defining Jurisdictional Boundary

4. A right-of-way survey will define a jurisdictional boundary if the road, railway, or other right-of-way is to be transferred to another jurisdiction (e.g., a road through an Indian Reserve that is to be vested in a province).

### 2.5.4 Plan Preparation

5. See *Section 2.2: Guidelines for Preparation of Survey Plans* in the National Standards.
6. Show on the plan the full extent of each parcel from which the right-of-way will take land. If necessary, this can be shown on a key plan.
7. Designate the remainder of the parcel from which the right-of-way has taken land with the parcel number followed by the term "Remainder" or the abbreviation "Rem." (e.g., 17 Rem.) unless a new parcel number is required by the government body administering the land or the registrar of the applicable land titles office or registry.
8. If the remainder is given a new parcel number and surveyed, include it in the lands dealt with on the plan.

If the remainder is not surveyed, see paragraph 50 in *Section 2.2.5: Remainders and Designation of Remainders* in the National Standards.



- 9. If a right-of-way has parallel boundaries and is monumented on only one side, it is sufficient to dimension only the monumented side. Show the right-of-way width.
- 10. If a right-of way will sever land from parcels, add a reference table to the plan as shown in the example below:

Lot Number	CLSR Plan	Area taken from Lot for R-of-W
101	64239	155 m <sup>2</sup>
102	45675	2.97 ha
102	45675	6.49 ha
103	64239	155 m <sup>2</sup>

**2.5.5 Title of Plan**

- 11. If a plan is prepared for the sole purpose of defining the extent of a right-of-way, use one of these forms for the title:

*Plan of Survey of Right-of-Way for Irrigation Canal in Sections 18 and 19, TP7, R23 W4thM*

*Plan of Survey of Highway No 1 Widening through Parcels 1 to 6, Plan 99999 CLSR*

**2.5.6 Specimen Plan**

*Link:*

[#8 Plan of Survey of Highway Widening](#)

([\*https://clss.nrcan-mcan.gc.ca/clss/surveystandards-normesdarcentage/\*](https://clss.nrcan-mcan.gc.ca/clss/surveystandards-normesdarcentage/))



## 2.6 Resurvey Plans

### 2.6.1 Definition of Resurvey

1. In the Canada Lands Survey System, a resurvey is a survey carried out under Section 33 of the *Canada Lands Surveys Act*.

Resurveys under Section 33 are carried out to correct errors or supposed errors, to re-establish lost monuments, or at the request of a member of the Privy Council for Canada or the Commissioner of the Northwest Territories, Yukon, or Nunavut. After confirmation, the plan becomes the Official Plan of the affected lands.

2. Most new surveys of boundaries and parcels involve retracing previously surveyed boundaries and re-establishing lost or disturbed monuments or restoring obliterated monuments.

Such work does not constitute a resurvey as defined in the *Canada Lands Surveys Act*. This type of re-establishment or restoration is normally incorporated into a plan of survey for a boundary or parcel. If it is not, the surveyor must prepare field notes of the re-establishment or restoration in accordance with *Chapter 3: Field Notes* in the National Standards and submit them to the Surveyor General Branch.

### 2.6.2 Plan Preparation

3. See *Section 2.2: Guidelines for Preparation of Survey Plans* in the National Standards.

### 2.6.3 Title of Plan

4. Use one of these forms for the title of a resurvey plan:

*Plan of Resurvey of (Part of) the Exterior Boundary of \_\_\_\_\_ (name of Canada Lands)*

*Plan of Resurvey of Parcel 12, Plan 55555 CLSR*

### 2.6.4 Specimen Plan

Link:

[#9 Plan of Resurvey of Jurisdictional Boundary](#)

(<https://clss.nrcan-rncan.gc.ca/clss/surveystandards-normesdarcentage/>)



## 2.7 Compiled Plans

### 2.7.1 Definition of Compiled Plan

1. A compiled plan is a plan of parcels or boundaries produced using survey field note information of record in the CLSR, as well as incorporating that information shown on plans registered in a provincial or territorial Land Titles office. The compiled plan may contain additional field notes of survey.
  - a. If a compiled plan is being contemplated, the surveyor must clearly state this when requesting instructions and demonstrate the suitability of this product. Specific instructions will authorize this type of plan if appropriate.

### 2.7.2 Use of Compiled Plans

2. Compiled plans may be prepared for:
  - a. creation of a new parcel or parcels where boundaries are dealt with on several plans and/or field notes in the CLSR;
  - b. elimination of a parcel remainder by giving it a new parcel number and dealing with it on a compiled plan (see *Section 2.2.5: Remainders and Designation of Remainders* in the National Standards);
  - c. creation of one plan for an area from several plans where the number of plans and the changes to boundaries and parcels result in confusion or uncertainty; and
  - d. consolidation of existing parcels.

### 2.7.3 Plan Preparation

3. See *Section 2.2: Guidelines for Preparation of Survey Plans* in the National Standards.
4. If new field survey work was carried out to define some of the boundaries to be shown on the compiled plan, the field notes may either:
  - a. be recorded in the CLSR separately prior the recording of the compiled plan; or
  - b. be included in the compiled plan, provided that the final product is organized and uncluttered.
5. Information used to prepare compiled plans may include:
  - a. field notes recorded in the CLSR;
  - b. plans recorded in the CLSR;
  - c. plans of record in provincial land titles or land registry offices; and
  - d. new field notes of survey shown on the compiled plan.
- 5.1 The compiled plan body will be drafted such that copied boundary measurements (bearing/distances) are easily distinguishable from new measurements.
6. Plans of record in provincial land titles or land registry offices may be used, provided that the source (e.g., LTO plan number) is noted on the compiled plan.



7. New boundaries may be created on a compiled plan by computing the bearing and distance between monuments, provided that the standards for survey accuracy can be met. The bearing and distances must be identified on the plan as calculated.
8. If a compiled plan is to be confirmed, it must have been fully monumented.
9. [Repealed]
10. In the title block, list the CLSR numbers of all the plans and field notes used to compile the plan, along with the file, deposit, or registration numbers of any plans in land titles or land registry offices used for the compilation.
11. In the legend, include a bearing statement similar to the following:  

For grid bearings:

*Bearings are grid copied from Plan \_\_\_\_\_ CLSR and according to that plan are referred to the central meridian of UTM [or MTM] Zone \_\_\_\_\_ (number).*

For astronomic bearings:

*Bearings are astronomic copied from Plan \_\_\_\_\_ CLSR and according to that plan are referred to the meridian through \_\_\_\_\_ (describe the position).*

If bearings from more than one plan are used, they must be rotated so that they are referred to the reference meridian cited in the bearing statement. Include on the plan a statement that bearings on all plans have been rotated to conform to the bearings on the plan referred to in the bearing statement.
12. Include one of the following statements as applicable to the title block:
  - a. *The boundary information on this plan has been compiled from information as noted, and no new field work was performed to verify the monuments, measurements, or potential boundary encroachments.*
  - b. *The boundary information on this plan has been compiled from information as noted and the field notes contained herein. Except for the field notes included on this plan, no new field work was performed to verify the monuments, measurements, or potential boundary encroachments.*
13. On the diagram of the plan, show the CLSR plan numbers and field note numbers of each survey used to compile the plan. To enable tracing of the plan information, show the CLSR numbers in the location of each survey to which they pertain.
14. Do not show monuments on the plan for the compiled portion of the plan unless requested by the specific instructions or Land Registry.
15. Show distances taken from recorded plans and field notes on the compiled plan in a common unit of measure (e.g., ground distances in metres).
16. Do not show geo-referencing information if no new field work was performed.



#### 2.7.4 Title of Plan

17. Use this form for the title of a compiled plan:

*Compiled Plan of Parcels (Lots) D to H*

*Compiled Plan of the Exterior Boundary of \_\_\_\_\_*

*Compiled Plan of Lots ..... and Field Notes of Survey*

#### 2.7.5 Specimen Plans

*Links:*

[#10 \*Compiled Plan of Lots\*](#)

[#11 \*Compiled Plan of Lots\*](#)

[#11A \*Compiled Plan of Lots ..... and Field Notes of Survey\*](#)

(<https://clss.nrcan-rncan.gc.ca/clss/surveystandards-normesdarcentage/>)





## 2.8 Explanatory Plans

### 2.8.1 Definition of Explanatory Plan

1. Explanatory plans clearly and unambiguously show the relationship of the boundaries of an interest to existing surveyed boundaries or monuments.

### 2.8.2 Use of Explanatory Plans

2. Explanatory plans prepared under Section 31 of the *Canada Land Surveys Act* are used to define the boundaries of short-term or non-exclusive interests (e.g., short-term leases, utility easements, access roads, permits, and First Nation surrender or designation votes).

They may also be used for exclusive-use interests, including fee simple, for purposes such as parcel consolidations, replacing metes and bounds descriptions, and road closures, provided that using explanatory plans for these purposes is acceptable to the government body administering the land or the registrar of the applicable land titles or registry office.

3. If a non-exclusive use right-of-way crosses a large, unsurveyed area (more than one kilometre), or if the boundaries of the right-of-way cannot easily be related to existing surveyed boundaries or monuments, do one of the following:
  - a. survey the right-of-way (see *Section 2.5: Highway, Railway, and Similar Right-of-Way Survey Plans* in the National Standards); or
  - b. place control monuments along the right-of-way, prepare field notes of the control survey, and prepare an explanatory plan showing the boundaries related to the control monuments.
4. If monuments are re-established or restored, or if a difference is found between a measurement made in the field and a dimension on an existing plan, prepare field notes in accordance with *Chapter 3: Field Notes* in the National Standards.

### 2.8.3 Plan Preparation

5. See *Section 2.2: Guidelines for Preparation of Survey Plans* in the National Standards.
6. Show the name of the surveyor who prepared the plan and the year in this form:  
*Prepared by \_\_\_\_\_ (name), CLS in \_\_\_\_\_ (year)*
7. Clearly show the parcels affected by the interest.
8. Define the boundaries of the interest in relation to existing surveyed boundaries or monuments.
9. If the interest described by the explanatory plan is in a parcel, the boundaries of the interest may be shown with dashed lines if this is necessary to clearly show that a severance is not intended.



10. Provide the area of the interest described by the explanatory plan. If the interest extends over one or more parcels, provide the area of the interest within each parcel.

A table may be used similar to that shown in paragraph 10, Section 2.5.4: *Highway, Railway, and Similar Right-of-Way Plans - Plan Preparation* in the National Standards.

11. The plan must contain a bearing statement similar to the following:

For grid bearings:

*Bearings are grid copied from Plan \_\_\_\_\_ CLSR and according to that plan are referred to the central meridian of UTM [or MTM] Zone \_\_\_\_\_ (number).*

For astronomic bearings:

*Bearings are astronomic copied from Plan \_\_\_\_\_ CLSR and according to that plan are referred to the meridian through \_\_\_\_\_ (describe the position).*

If bearings from more than one plan are used, they must be rotated so that they are referred to the reference meridian cited in the bearing statement. Include on the plan a statement that bearings on all plans have been rotated to conform to the bearings on the plan referred to in the bearing statement.

12. Show only monuments as dealt with on the underlying plan, and show the monument type.

Do not show the monument information specified in paragraphs 41 to 44 in *Section 2.2.4: Diagram - Monuments and Ancillary Monuments* in the National Standards.

13. Do not show geo-referencing information.

14. Label the interests on the diagram of the plan (e.g., access road, utility right-of-way, utility easement, etc.).

15. A utility or access road right-of-way required for an easement or other non-exclusive interest may be shown on a parcel plan if this is acceptable to the government body administering the land or the registrar of the applicable land titles or registry office. (See *Specimen Plan #7: Plan of Survey of Lots and Road and Utility Right-of-Way* (<https://clss.nrcan-rncan.gc.ca/clss/surveystandards-normesdarcentage/>)).

#### 2.8.4 Title of Plan

16. Use this form for the title of an explanatory plan:

*Explanatory Plan of (Power Line, Utility, Access Road) Right-of-Way over Lots 1 to 77 and Road, Trout Creek Subdivision*

*Explanatory Plan for Gravel Permit in Section 24, Township 52, Range 23, W4th M, First Nation Reserve, ...*

*Explanatory Plan of Parcel for Designation Vote in Section 24, Township 52, Range 23, W4th M, First Nation Reserve, ...*



## 2.8.5 Specimen Plans

*Links:*

[#7 Plan of Survey of Lots and Road and Utility Right-of-Way](#)

[#12A Explanatory Plan of Utility Right-of-Way](#)

[#12B Explanatory Plan of Parcel](#)

(<https://clss.nrcan-rncan.gc.ca/clss/surveystandards-normesdarcentage/>)

## 2.9 Administrative Area and Land Use Area Plans

### 2.9.1 Use of Administrative Area and Land Use Area Plans

1. These plans are commonly used for illustrating areas of land for administrative purposes or for certain short term or limited uses of land where boundaries do not need to be defined by, or referred to, surveyed boundaries. For example plans for zoning or plans of land use areas for agricultural permits.

### 2.9.2 Plan Preparation

2. Plans are usually prepared under contract to the Surveyor General Branch using specific survey instructions.
3. Boundaries on these plans may be as defined by:
  - a. existing plans;
  - b. descriptions contained in legislation, orders-in-council, or other official documents;
  - c. their relationship to boundaries defined on existing plans;
  - d. natural or man-made features;
  - e. NAD83 CSRS coordinates; and/or
  - f. new surveys.



## Chapter 3: FIELD NOTES

### 3.1 Introduction

1. Field notes are the synthesis of the data collected in the field during the execution of the survey. Field notes of survey prepared by a surveyor and submitted to the Surveyor General are filed in the CLSR in accordance with Section 18 of the *Canada Lands Surveys Act*.
2. In most cases, field notes are included in a survey plan (see *Chapter 2: Survey Plans* in the National Standards), and separate field notes are not required. Occasionally, where field note information will clutter the plan, supplementary field notes are required for clarity.
3. In other cases, field notes may be the sole product being submitted. For example, where survey work has been conducted but will not result in a confirmed or approved plan as specified in *Chapter 2: Survey Plans* in the National Standards, field notes must be filed to officially record the surveyor's measurements and any placed, re-established, or restored monuments.
4. Field records are the raw data collected in the field. Although field notes are filed in the CLSR, this raw data must also be retained and held by the surveyor, who may be required to submit field records or copies thereof at a later date.

### 3.2 Information to be shown on Field Notes

5. The information to be shown on field notes varies, depending on their purpose. For example, field notes in plan form showing extensive survey work not resulting in a confirmed or approved plan will normally contain more detailed information than supplementary field notes for a plan.
6. The provisions of *Section 2.2: Guidelines for Preparation of Survey Plans* in the National Standards apply to the preparation of field notes to the extent that they are relevant to field note information.
7. As a general rule:
  - a. It is preferable to show observed geo-referenced positions and measured distances and bearings on field notes. If distances and/or bearings are calculated, show them as calculated. If bearings and distances and/or coordinates are derived from adjusted coordinate files, state that in the field notes.
  - b. It is preferable to show ground distances on field notes. If grid distances are shown, clearly indicate that they are grid.
  - c. Do not provide parcel areas or depict lands as dealt with on field notes.
  - d. Locations and descriptions of land interests are not required on field notes.
8. Refer to *Section 3.4: Specimen Field Notes* in the National Standards for additional guidance on the information to be shown in field notes.



### 3.3 Forms of Field Notes

9. Field notes may be prepared in whichever of the following forms is the most suitable for clarity and completeness:
  - a. Plan form: Field notes in plan form should comply with the provisions of *Section 2.2: Guidelines for Preparation of Survey Plans* in the National Standards to the extent that those provisions are relevant to field note information.
  - b. Book form: Field notes in book form may be either the original field records made by the surveyor (if they are clear and easily understandable) or a clear and understandable compilation of the original field records.
  - c. *Field Note of Re-Establishment and/or Restoration of Monument(s)*: This is the preferred form for simple re-establishments or restorations of one or two monuments, and was previously known as a form LS56.

### 3.4 Specimen Field Notes

*Links:*

[#13 Supplementary Field Notes \(in Plan Form\)](#)

[#14 Field Notes of Survey of Parcels \(in Plan Form\)](#)

[#16A Field Notes of Restoration of Monuments \(LS56\)](#)

[#16B Field Notes of Re-Establishment and Restoration of Monuments \(LS56\)](#)

(<https://clss.nrcan-rncan.gc.ca/clss/surveystandards-normesdarcentage/>)



## Chapter 4: SURVEY REPORTS

### 4.1 When Is a Survey Report Required?

1. A survey report is required if more information or documentation is required than that shown on the surveyor's submitted plans and/or field notes (see Section 5.1.3 (4) and (6) of Chapter 5: Water and other Natural Boundaries).
2. A survey report is not required if there is nothing more to report.

### 4.2 Content of Survey Reports

3. The survey report explains circumstances and the actions taken if it was not possible to comply with the National Standards, the specific survey instructions, or other requirements of the survey.
4. The following information must be submitted as part of a survey report if it is not evident on the survey plan or included in the field notes:
  - a. legal principles used to restore or re-establish monuments;
  - b. how access will be provided to parcels on First Nation Lands when those parcels will be used to define interests to be registered in the Indian Lands Registry;
  - c. discrepancies with previous surveys and how they were dealt with; and
  - d. geo-referencing information as specified in *Chapter 2: Survey Plans* in the National Standards.
5. The following documentation must be included in the survey report if it is not included with the field notes:
  - a. reports on verbal or other evidence obtained;
  - b. copies of any plans or other documents relevant to the survey that are not of public record and that have not been previously submitted;
  - c. any imagery and terrestrial photographs of water boundaries; and
  - d. any affidavits regarding evidence of boundaries taken during the course of the survey.
6. Include any other information that is relevant to the survey but not shown on the plan or in the field notes, including any survey problems encountered and how they were dealt with.
7. Include information or documentation regarding compliance with other relevant provisions of the National Standards (e.g., for particular products) and compliance with the specific survey instructions.
8. If additional information is required regarding the digital spatial file (see *Appendix E: Digital Spatial File Specifications* in the National Standards), submit it as part of the survey report.





9. Keep the survey report as succinct as possible.

Do not include photographs, imagery, computer printouts, or other information that does not pertain to a specific matter addressed by the report.

#### **4.3 Processing of Survey Reports**

10. Survey reports must be certified in accordance with the *Canada Lands Surveyors Regulations*, and are recorded in the CLSR as Field Books (FB).



## Chapter 5: WATER AND OTHER NATURAL BOUNDARIES

### 5.1 Water Boundaries

#### 5.1.1 Introduction

1. An upland parcel bounded by a body of water has a water boundary. Such a body of water includes non-tidal watercourses (lakes, rivers, and streams) and tidal reaches (oceans, straits, and bays), but excludes wetlands (marshes, swamps, and bogs).

#### 5.1.2 Location of Water Boundaries

2. Locate the water boundaries in keeping with provincial or territorial legislation, case law, or custom—e.g., *Present Natural Boundary* (of a body of water) in BC, *Bank* in Alberta, *Water's Edge* in Ontario, and *Ordinary High Water Mark (OHWM)* in the territories.

See *Appendix A: Glossary* in the National Standards for the definition of ordinary high water mark.

#### 5.1.3 Survey Methods

3. The location of a water boundary can be determined using any method that enables the boundary to be plotted at the final plan scale to an accuracy of 0.5 mm relative to other features on the plan as shown in the table below:

Plan Scale	1:10,000	1:5,000	1:2,000	1:1,000
Relative Accuracy (metres)	+/- 5.0 m	+/- 2.5 m	+/- 1.0 m	+/- 0.5 m

4. Take sufficient terrestrial photographs of visible water boundaries to illustrate the character and location of the boundary. Mark the location of the water boundary on the photographs, record the positions where the boundary photographs were taken, and include the marked-up terrestrial photographs with the field notes or survey report (see *Chapter 4: Survey Reports* in the National Standards).

5. If the water boundary is plotted from information sources such as aerial photographs, maps, or imagery that the surveyor has not prepared, the surveyor must independently verify that the plotting accuracy of 0.5 mm at the final plan scale can be achieved. Such verification includes taking field measurements if necessary.

6. If the water boundary is plotted from information sources such as aerial photographs, maps, or imagery that the surveyor has not prepared, the surveyor must inspect the boundary on the ground, mark the location of the water boundary on the information source, and include the marked-up information with the field notes or survey report.

A sufficient sampling of boundary locations must be made to enable identification of the water boundary where it is comprised of different types of land (rock, beach, vegetation, etc.).

7. If the location of a water boundary is determined by using a photogrammetric or mapping process, include in the field notes or survey report a description of the process used and



the origin and reference of the information sources (name of public agency, map numbers, aerial photograph numbers, etc.).

Also, include a list of all control monuments or control points used and include their descriptions if they are not of public record.

8. In Yukon, where a parcel of land being surveyed excludes a reservation along a body of water, such as the 30.48-metre reserve, determine the location of the water boundary, and survey and monument a series of artificial boundaries that excludes the reservation.

#### 5.1.4 Plan Preparation

9. When preparing a plan of survey that includes water boundaries, refer to the specimen plans below in *Section 5.1.5: Specimen Plans and Field Notes* and comply with the provisions of *Chapter 2: Survey Plans* in the National Standards.
10. If the location of the water boundary is determined by measurement in the field, show sufficient measurements (bearings and distances of traverse lines, offset distances, radial ties, and/or GNSS coordinates) to show the location of the water boundary.
11. Show measurements and/or coordinates in table form if required for clarity.
12. If multiple measurements will clutter the plan, show them on separate field notes.
13. Show the CLSR number of any plan or reference to aerial photographs, imagery, or other data used to plot the location of the water boundary.
14. Label the water boundary in keeping with the provincial or territorial custom (e.g., *Present Natural Boundary* in BC, *Bank* in Alberta, *Water's Edge* in Ontario, *OHWM* in Yukon, etc.).

#### 5.1.5 Specimen Plans and Field Notes

*Links:*

[#1 Plan of Survey of Jurisdictional Boundary, South of 60](#)

[#2 Plan of Survey of Jurisdictional Boundary, North of 60](#)

[#4 Plan of Survey of Parcel and Road](#)

[#13 Field Notes of Survey of Jurisdictional Boundary \(in Plan Form\)](#)

(<https://clss.nrcan-rncan.gc.ca/clss/surveystandards-normesdarcentage/>)



## 5.2 Other Natural Boundaries

### 5.2.1 Definition of Natural Boundary

1. Other than water boundaries, natural boundaries may include natural features such as banks that are not water boundaries, watershed lines, and ridge lines.

### 5.2.2 Survey Methods

2. If the natural boundary is indistinct, such as may occur for a watershed boundary in flat land or a high-usage area, it is preferable to survey the boundary as a monumented series of straight lines if this is legally possible.
3. The survey methods used in determining the location of other natural boundaries are the same as those used for water boundaries except that:
  - a. terrestrial photographs of boundaries are not required unless they are needed to illustrate the character of the boundary; and
  - b. if the natural boundary is plotted from information sources such as aerial photographs, maps, or imagery, it is necessary to inspect the boundary on the ground and mark the location of the natural boundary on the information source only if the location of the boundary would otherwise be uncertain.

### 5.2.3 Plan Preparation

4. Plan preparation for other natural boundaries is the same as that for water boundaries except that the natural boundary should be labelled *Watershed Line*, *Top of Bank*, *Ridge Line*, etc.

### 5.2.4 Specimen Plan and Field Notes

Link:

[#3 Plan of Survey of Jurisdictional Boundary, National Park – Bilingual](#)

(<https://clss.nrcan-rncan.gc.ca/clss/surveystandards-normesdarcentage/>)



## Chapter 6: DEFERRED MONUMENTATION

### 6.1 Definition of Deferred Monumentation

1. Deferred monumentation is the postponement of the placing of monuments that mark the boundaries of a parcel on a plan of survey until after the plan has been confirmed or approved and recorded in the Canada Lands Survey Records or after it has been filed or registered in a land titles office.

### 6.2 Use of Deferred Monumentation

2. Deferred monumentation may be considered when it will reduce monument destruction due to grading and construction or provide flexibility in timing of monumentation to suit ground conditions.
3. Deferred monumentation must be acceptable to the government department, First Nation, or other body administering the land. In the Northwest Territories and Nunavut, Section 9 (2) and in Yukon, Section 14 of the Land Titles Plans Regulations have provisions for deferred monumentation.
4. Deferred monumentation requires:
  - a. [Repealed]
  - b. Plan of Survey (which includes a Control Survey Network); and
  - c. Field Notes of Survey (to show the placement of the deferred monuments).
5. [Repealed]
6. Until monuments are placed at the geometric positions of the parcel boundaries shown on the plan, the control network along with the geometric relationships of bearings and distances on the plan of survey define the unmonumented parcel boundaries.

### 6.3 Survey Methods

7. A control survey network of GCPs must be established in safe and protected locations. There must be a sufficient number of monuments to provide redundancy in measurement and an adequate distribution throughout the surveyed area. GCPs should be placed as close as reasonable to the deferred posting location. GCPs of the control survey network must comply with the requirements of Chapters 1 and 2 of the National Standards.
  - a. [Repealed]
  - b. [Repealed]
8. [Repealed]
9. [Repealed]
10. Any monuments for parcels in the survey that will not be subject to destruction from construction and grading, or that do not need to be deferred because of ground



conditions, should be placed and included in the plan of survey and tied to the control survey network.

#### 6.4 [Repealed]

11. [Repealed]

12. [Repealed]

#### 6.5 Plan of Survey

13. When preparing a plan of survey that includes deferred monumentation, refer to the relevant specimen plans below in Section 6.8 Specimen Plans and comply with the provisions of Chapter 2: Survey Plans in the National Standards.

In addition:

- a. Show in a table the coordinates for a selection of new or found monuments at principal points that provide additional control; and
  - b. Show in the diagram of the plan the dimensions of the boundaries of all new parcels to be dealt with by the plan and the location of all points where monuments will be placed. Identify each point with a distinctive symbol that is shown and explained in the legend.
14. Include in the title block the following notations:

*The placement of monuments at all points shown on this plan with the symbol for deferred monuments has been deferred for a period of time not to exceed one year from the date of filing/registration in the land titles office [or recording in the Canada Lands Survey Records] or any extension thereof granted by the Surveyor General and, if applicable, by the Registrar.*

*See the following Plan(s) of Field Notes showing the placement of monuments:*

\_\_\_\_\_ CLSR, \_\_\_\_\_ LTO (when applicable)

#### 6.6 [Repealed]

15. [Repealed]

16. [Repealed]

#### 6.7 Field Notes of Final Placement of Monuments

17. When preparing field notes showing placement of monuments, comply with the provisions of *Chapter 3: Field Notes* in the National Standards to the extent that those provisions are applicable. In the situation where monuments cannot be placed in the position shown on the Plan of Survey, Field Notes must be prepared in plan form and the location of the witness monuments placed must be indicated on the plan. The dimensions of the parcel boundaries and their location shall be the same as on the survey plan. A note shall be added to identify monuments that are not placed at the locations shown on the Plan of Survey.



18. [Repealed]

## 6.8 Specimen Plans

*Links:*

[#18 Plan of Survey of Lots, Blocks and Road \(for Deferred Monumentation\)](#)

[#19 Field Notes of Survey of Placement of Monuments \(for Deferred Monumentation\)](#)

(<https://clss.nrcan-rncan.gc.ca/clss/surveystandards-normesdarcentage/>)





## Chapter 7: BUILDING UNIT SURVEYS

### 7.1 Definition of Building Unit Survey

1. A Building Unit survey can be for an entire building or multiple units within a building. The plans can be used to support a lease interest or First Nation allotment of a building or portion thereof.

A Building Unit Survey is a survey that defines an area within a building, enclosed by walls, floors and ceilings, or the whole of a building. Building unit surveys may also define exclusive use areas that may be allocated to a particular building unit (e.g. patios, decks, parking areas) or common elements (property) (e.g. hallways, stairwells).

### 7.2 Survey Methods

2. The position of the building within the parcel must be determined and related to the parent parcel or, if no parent parcel exists to the nearest cadastral boundary if within 300 meters of the building unit. Determine the location of the building with offsets or ties to the boundaries of the parcel. If there is no parent parcel and the nearest boundary is more than 300 meters away, the location may be determined with geo-referencing and ties to GCPs (see Chapter 1.9 of the National standards).
3. The feature that was adopted as the exterior of the building should be noted. The horizontal measurements of the exterior of the building must be measured at the adopted feature.
4. The building unit is defined by horizontal measurements to the inner surface, outer surface or center of walls, floors and ceilings. Where interior walls are not convenient to the occupants, interior unit boundaries may be defined using stable, identifiable features within the building, e.g. columns or lead plugs in slab.
5. [Repealed]
6. Sufficient horizontal and vertical measurements must be made to demonstrate the relationship of each unit to the other units and to the exterior of the building.
7. Exclusive-use areas must be measured and related to the position of the unit, the exterior walls of the building, or the boundaries of the parcel.
8. [Repealed]

### 7.3 Plan Preparation

9. See Section 2.2: *Guidelines for Preparation of Survey Plans* in the National Standards.
10. Show in the diagram of the plan:
  - a. The dimensions of the parcel as measured during the course of the survey or copied from previously registered plan(s) in the CLSR. Copied information must be easily distinguishable from new measurements.



- b. The dimensions of the building exterior walls, showing their locations within the parcel or if applicable with respects to GCPs.
  - c. The dimensions of all boundaries of each building unit and exclusive-use area.
  - d. The relationship between:
    - i. the building and adjacent buildings;
    - ii. the units and the other units, the exterior walls of the building, and any associated exclusive areas ; and
    - iii. any exclusive areas and units, the exterior walls of the building, and to the boundaries of the parcel. Include a note for each exclusive use area indicating which building unit it serves if applicable.
  - e. The total area of:
    - i. each unit including the area of each level when comprised of more than one level for building unit surveys. A separate area may be provided for attached garage portions;
    - ii. each exclusive use area; and
    - iii. the footprint of the building when the unit represents the whole of a building.
  - f. Horizontal dimensions to 0.01 m for all dimensions and areas to 0.1 m<sup>2</sup> for all areas.
  - g. Cross-Sections to illustrate the vertical relationship of the building units and exterior of the building including roof, where not evident.
11. In addition to showing the feature used for the exterior of the building, the plan will include a statement that clearly defines the horizontal and vertical boundaries of the building unit.
12. Show in the legend of the plan:
- a. a list of plans from which dimensions of the parcel were copied if applicable; and
  - b. the period in which building position and unit dimensions were measured
13. If all the information for the plan cannot be shown clearly on one sheet, include additional sheets and show the title of the plan on each sheet. The first sheet must provide space for all required certifications and approvals.

In the top right-hand corner of each sheet, show the sheet number and the total number of sheets in the plan in this form:

*Sheet \_\_\_\_ of \_\_\_\_ sheets*

#### 7.4 Title of Plan

14. The title must clearly identify all units dealt with by the plan. For example:
- Plan of Survey of Building Units \_\_\_\_ to \_\_\_\_ within Lot
  - Plan of Survey of Building Units \_\_\_\_ to \_\_\_\_ within the IR



## 7.5 Specimen Plans

*Links:*

[#20A Plan of Survey of Building Units](#)

[#20B Plan of Survey of Building Units](#)

[#20C Plan of Survey of Building Units without Parent Parcel](#)

(<https://clss.nrcan-rncan.gc.ca/clss/surveystandards-normesdarcentage/>)



## Chapter 8: CONDOMINIUM SURVEYS

### 8.1 Introduction

1. Condominium plans are prepared under specific condominium legislation.
2. The objective of a condominium plan is to divide property into parts to be owned individually (called “units”) and parts to be owned in common (called “common property” in Alberta and “common elements” in the territories). Parts of the property owned in common may be designated as exclusive-use areas allocated to individual units.
3. Condominium plans may be in the form of:
  - a. building units defined by reference to floors, walls, and ceilings;
  - b. bare land units that describe parcels of land by reference to boundaries established by monuments; or
  - c. a combination of building units and bare land units.
4. It is the responsibility of the surveyor to comply with the legislated requirements and land titles procedures for condominiums in the jurisdiction where the condominium survey is carried out.
5. In National Parks in Alberta, Alberta’s *Condominium Property Act* and Regulations and its land titles procedures are used for condominium surveys (for administrative convenience).

In the territories, the requirements for the content of condominium plans are addressed in Sections 6 (2) to 6 (5) of the *Condominium Act* (NT), Sections 6 (2) to 6 (5) of the *Condominium Act* (NU), and Sections 6 (1) to 6 (4) of the *Condominium Act* (YT).

### 8.2 Condominium Surveys in National Parks in Alberta

6. Building and bare land units dealt with in National Parks in Alberta must be located on a surveyed parcel (called a parent parcel) for which a certificate of title for a leasehold estate has been issued under Alberta’s *Land Titles Act*.
7. All boundaries of the parent parcel(s) must be retraced during the course of the survey, and any monument(s) obliterated, disturbed, or lost must be restored or re-established. The retracement survey must be shown on the condominium plan. If the retracement survey is used to prepare a plan of resurvey of the parent parcel, prior to the registration of the leasehold condominium plan, a new leasehold title or a renewal of lease must be issued as described in the *Alberta Land Titles Procedure Manual: LEA-1, Leases*.
8. For additional requirements, see the *Alberta Land Titles Procedure Manual: SUR-4, Surveys - Examination of Condominium Plans*.
9. The title of the plan should be:

*Plan of Survey of Leasehold Condominium*



### 8.3 Condominium Surveys in NT, NU, and YT

#### ***Parent Parcel***

10. Building and bare land units dealt with in the Northwest Territories, Nunavut, and Yukon must be located on a surveyed parcel (called a parent parcel) for which a certificate of title has been issued.
11. All boundaries of the parent parcel(s) must be retraced during the course of the survey and any monument(s) obliterated, disturbed, or lost must be restored or re-established. Show the retracement survey on the condominium plan.
12. If a plan of survey for the parent parcel or for a new parent parcel is prepared, the plan must be registered and a certificate of title issued prior to registration of the condominium plan.

#### ***Survey Methods for Building Unit Condominiums***

13. The dimensions of the exterior walls of the building must be measured, the exterior walls at ground level must be connected to the boundaries of the parent parcel, and the feature defining the exterior walls must be recorded.
14. The boundaries of a building unit should be features such as the inner surface, median plane, or outer surface of walls, floors, and ceilings.
15. The horizontal and vertical dimensions of the building units must be measured.
16. Sufficient horizontal and vertical measurements must be made to determine the relationship of each unit to the other units and to the exterior walls of the building at ground level.
17. If exclusive-use areas such as parking areas, decks, and patios are to be defined, they must be measured and related to the position of the building unit or exterior walls of the building or to the boundaries of the parent parcel.

#### ***Plans for Building Unit Condominiums***

18. See *Section 2.2: Guidelines for Preparation of Survey Plans* in the National Standards.
19. In the title of the plan:
  - a. identify the plan in this form:

*Plan of Survey of Condominium Units 1 to 4 and Common Elements  
(Comprising Lot 125, Plan 98765 CLSR, etc.)*
  - b. include the legal description of the parent parcel(s); and
  - c. comply with the specific survey instructions and the land titles procedures.
20. Show in the diagram of the plan:
  - a. The monuments and dimensions of the parent parcel as measured during the course of the survey.



- b. The dimensions of the building exterior walls at ground level, showing their locations with measurements to the boundaries of the parent parcel. The feature defining the exterior walls must be noted on the plan.
  - c. The dimensions of all boundaries of each building unit and each exclusive-use area.
  - d. Sufficient horizontal and vertical dimensions to show the relationship of:
    - i. the units to the other units and to the exterior walls of the building at ground level; and
    - ii. any exclusive-use areas to units, to the exterior walls of the building at ground level, or to the boundaries of the parent parcel;
  - e. The total floor area of each unit and the area of each exclusive-use area. In Yukon, if the unit is comprised of more than one level, show the floor area for each level and the total floor area.
  - f. Horizontal dimensions to 0.01 m for all dimensions and areas to 0.1 m<sup>2</sup> for all areas.
  - g. Cross-sections to accurately illustrate the vertical relationships of the building units and the exterior of the building, including the outline of the roof.
21. The plan must include a statement that clearly defines the boundaries of the building units by reference to the building floor, wall, and ceiling, either in the legend or with a suitable notation on the plan.
22. Units, common elements (property), and exclusive-use areas must be designated in a manner that clearly distinguishes them from each other.
23. If required by the applicable land titles procedures, show unit factors of each unit corresponding to the total area of all the units in the condominium.
24. Unit numbering must comply with the specific survey instructions or the applicable land titles procedures.
25. If all the information for the plan cannot be shown clearly on one sheet, include additional sheets and show the title of the plan on each sheet. The first sheet must provide space for all required certifications and approvals.

In the top right-hand corner of each sheet, show the sheet number and the total number of sheets in the plan in this form:

Sheet \_\_\_\_ of \_\_\_\_ sheets.

### ***Bare Land Unit Condominiums, Surveys, and Plans***

26. Bare land units must be surveyed and plans must be prepared in accordance with the applicable provisions in *Chapter 1: Surveys* and *Chapter 2: Survey Plans* in the National Standards.
27. Monument all corners of bare land units. If it is not possible or practicable to monument a corner, specify on the plan the reason why the corner could not be monumented.



28. The Surveyor General may permit modified posting at specified corners if the bare land units are much smaller than normal residential lots in the area and are laid out in a regular grid pattern. Apply in writing for modified posting of bare land units when requesting survey instructions, and provide the reason.
29. In addition to meeting the requirements for building unit condominium plans, bare land condominium plans must:
  - a. show the horizontal ground area to 0.1 m<sup>2</sup> of each bare land unit, of each exclusive-use area, and of the common elements (property); and
  - b. show buildings (if they are shown on the plan) with dashed lines and to scale; do not show dimensions relating buildings to parcel boundaries.

## 8.4 Specimen Plans

*Links:*

[#23 Plan of Survey of Condominium \(floor plan of building units\)](#)

[#24 Plan of Survey of Condominium \(X-section view of building units\)](#)

[#25 Plan of Survey of Bare Land Condominium](#)

*(<https://clss.nrcan-rncan.gc.ca/clss/surveystandards-normesdarcentage/>)*





## Chapter 9: AIR SPACE PARCEL SURVEYS

### 9.1 Definition of Air Space Parcel Survey

1. An air space parcel survey is a survey that describes a volume of space. Examples include underground tunnels, bridges, and overhead walkways.

Air space parcel boundaries are independent of physical structures, and are defined by planes or curved surfaces that have three-dimensional coordinates.

### 9.2 Survey Methods

2. The geometric shapes forming the boundaries of air space parcels should be limited to:
  - a. horizontal, vertical, or inclined plane surfaces; or
  - b. cylindrical surfaces or portions of cylindrical surfaces with axes that are horizontal, vertical, inclined, or curved.
3. The air space parcel must be positioned with respect to:
  - a. monuments marking the boundaries of the surveyed parcel in which it lies (the parent parcel); and
  - b. at least two benchmarks, the elevation of which may be published values or elevations obtained by GNSS.
4. If one of the benchmarks is not in the immediate vicinity of the air space parcel, establish a new stable benchmark on the site or in the immediate vicinity. The elevation of the new benchmark must be in the same vertical datum as that used for the air space survey.
5. If the position of any monument shown on a prior plan of survey is re-established or restored during the course of a survey, show the field note information on the air space parcel plan.

### 9.3 Plan Preparation

6. See *Section 2.2: Guidelines for Preparation of Survey Plans* in the National Standards.
7. Show in the diagram of the plan:
  - a. The monuments and dimensions of the parent parcel as measured during the course of the survey or copied from previously registered plan(s) in the Canada Lands Survey Records (CLSR). Label information that was copied as “copied;”
  - b. The location and dimensions of the boundaries of the air space parcel and the relationship of the air space parcel to the boundaries of the parent parcel;
  - c. A dimensioned isometric view that is a three-dimensional line drawing of the air space parcel; and
  - d. The elevation of each air space parcel corner and, if the air space parcel boundaries are not horizontal or vertical planes, the coordinates of the corners.



- e. The volume of each air parcels.
8. Show in the legend of the plan:
- a. a note describing the nature of the boundaries of the air space parcel (e.g., horizontal and vertical plane surfaces);
  - b. if elevations were obtained from published values, the number, description, elevation, and location of the benchmarks; and
  - c. if elevations were obtained by GNSS:
    - i. the elevation, description, and location of any new benchmarks established (and the number if an existing benchmark was used); and
    - ii. the version (epoch) of the NAD83 (CSRS) datum used and the geoid model used to reduce elevations to orthometric values.

#### 9.4 Title of Plan

9. Use this form for the title of an air space parcel survey plan:

*Plan of Survey of Air Space Parcel \_\_\_\_\_ within Lot \_\_\_\_\_*

#### 9.5 Specimen Plan

*Link:*

[#26 Plan of Survey of Air Space Parcels](#)

*(<https://clss.nrcan-rncan.gc.ca/clss/surveystandards-normesdarcentage/>)*



## Chapter 10: OIL & GAS SURVEYS ON FIRST NATION RESERVES

### 10.1 Introduction

1. Chapter 10 of the National Standards applies to surveys for surface rights pertaining to oil and gas development on First Nation Reserves (see definition of “Indian lands” in the *Indian Oil and Gas Act*) where rights are being disposed of pursuant to Section 27 of the *Indian Oil and Gas Regulations*. These include pipelines, wellsites, flow lines, access roads, and any other facility related to oil and gas resource development on a First Nation Reserve.
2. The surveyor must open a new project in MyCLSS before beginning an oil and gas survey on a First Nation Reserve, and is responsible for gathering all the survey and control information required to properly carry out the survey, including survey information from the regional office of the Surveyor General Branch.
3. Before commencing the survey, the surveyor must obtain authorization from the First Nation Band Council and any person or party that is in lawful possession of the land or has an interest in the land.
4. Chapters 1, 2, 3, and 4 of the National Standards apply to oil and gas surveys to the extent that their provisions are not inconsistent with the provisions of Chapter 10.

### 10.2 Survey Methods

5. Monuments placed for wellsites and access roads must be iron bars or spikes at least 30 cm long, or provincial or territorial monuments if these are of equal or greater length and durability.
6. For wellsites:
  - a. Position the wellsite relative to at least two found, restored or re-established monuments marking the section in which the wellsite lies or, if the reserve is not subdivided, to two monuments from which the position of the theoretical section can be calculated.
  - b. Place monuments at each corner of the wellsite.
7. For access roads:
  - a. Place monuments at the terminal points of the access road or on one boundary of the access road at an offset from the terminal point, as follows:
    - i. if the access road terminates at a prior surveyed boundary (including a wellsite boundary), locate the adjacent evidence marking that boundary; or
    - ii. if one or both of the adjacent monuments cannot be found, it is permissible to use a calculated intersection at the terminal point.
  - b. Place monuments at each change of direction.
  - c. If the boundaries of the access road intersect section lines, calculated intersections are required as a minimum.



8. For pipelines, carry out the survey as a right-of-way survey. For other related facilities, carry out the survey as a parcel survey.
9. Survey connections must be made to permanent structures that may serve as permanent reference positions, such as well casings, wellhead equipment, or concrete foundations.

### 10.3 Plan Preparation

10. See *Section 2.2: Guidelines for Preparation of Survey Plans* in the National Standards.
11. Show in the title of the plan:
  - a. the corporate name of the applicant for the surface rights; and
  - b. the name or number assigned to each wellsite by the provincial oil and gas conservation authority.
12. Show in the diagram of the plan:
  - a. the boundaries of the parcel required for oil and gas purposes, and the lengths and bearings of the surveyed lines;
  - b. the location of those portions of individual land holdings affected by the lands dealt with;
  - c. the position of each well relative to the boundaries of any unit of land used for the spacing of oil and gas wells;
  - d. areas required in each section, quarter section, or other surveyed parcel; and
  - e. connections to permanent structures that may serve as a permanent reference position, such as well casings, wellhead equipment, or concrete foundations.

### 10.4 Approvals and Certification

13. The plan of survey must be satisfactory to the Executive Director of Indian Oil and Gas Canada.

### 10.5 Survey Returns

14. Provide copies of the plan to the applicant (oil company or other entity applying for a surface lease or right-of-way agreement), certified correct in accordance with Section 38 of the *Canada Lands Surveyors Regulations*.
15. Upon being notified that the plan is satisfactory, expeditiously submit the plan (or a re-certified plan if changes were made) to the Cadastral Services Unit, Surveyor General Branch, along with the digital spatial file and any other required returns.
16. If an application for surface rights or a right-of-way is abandoned, it is not necessary to submit the plan to the Surveyor General Branch but field notes prepared in accordance with *Chapter 3: Field Notes* in the National Standards must be submitted if any monuments were placed, re-established, or restored during the course of the survey.



## 10.6 Specimen Plans

*Links:*

[#27 Plan of Survey of Wellsite and Access Road](#)

[#28 Plan of Survey of Pipeline Right-of-Way](#)

(<https://clss.nrcan-rncan.gc.ca/clss/surveystandards-normesdarcentage/>)



## Chapter 11: OIL & GAS SURVEYS – NT, NU, AND OFFSHORE

### 11.1 Introduction

This Chapter is for legal surveys carried out by Canada Lands Surveyors for oil and gas surveys in the Northwest Territories and Nunavut, and offshore Canada Lands.

On April 1st 2014, the new *Oil and Gas Land Regulations* under the *Northwest Territories Lands Act* came into force and are applicable to Territorial Lands in that Territory. It should be noted that though all references to Oil and Gas Regulations contained forthwith in this chapter are to the *Canada Oil and Gas Land Regulations*. They are generally applicable to the *Oil and Gas Land Regulations* for the Northwest Territories as well.

1. Legal surveys carried out by Canada Lands Surveyors (CLS) related to oil and gas are carried out under the *Canada Oil and Gas Land Regulations* in order to establish:
  - a. the position of a well on land within a unit of a grid area pursuant to Section 12, 13, 20, or 21 (2) (a) of the Regulations; and
  - b. the position of monuments on a fixed offshore platform pursuant to Section 21 (3) (a) of the Regulations.
2. The same survey and plan prepared under the *Canada Oil and Gas Land Regulations* is used to confirm the position of wells under Section 74 of the *Canada Oil and Gas Drilling and Production Regulations* and under parallel Regulations of the Canada-Newfoundland and Labrador Offshore Petroleum Board (CNLOPB), the Canada-Nova Scotia Offshore Petroleum Board (C-NSOPB), and the Northwest Territories Office of the Regulator of Oil and Gas Operations (OROGO).

Under the Production Regulations in the respective jurisdiction, a licensed Canada Lands Surveyor must certify the plan and a copy of the plan filed in the Canada Lands Survey Records (CLSR). However, the plan is not required for the disposition of oil and gas rights under the *Canada Oil and Gas Drilling and Production Regulations*. It is used only to confirm the position of wells for management and safety.

3. Revisions are required to some parts of the *Canada Oil and Gas Land Regulations*. When they came into force in 1961:
  - a. Under Section 9 of the Regulations, North American Datum of 1927 (NAD27) is the datum to be used for defining the latitude and longitude of grid areas, sections, units, and wells. However, North American Datum 1983 (NAD83) is now the coordinate reference system used in Canada.
  - b. Under Section 16 of the Regulations, if the position of any boundary of a grid area, permit area, lease area, section, unit, or well position has been established by a legal survey approved by the Surveyor General, the position of that boundary or well is deemed to be the true position, and it determines the position of all other sections or units within the grid area. In 1961, positioning technology was rudimentary, wells were most often in remote areas, and geodetic control was sparse. Now with Global Navigational Satellite Systems (GNSS), and improved acoustic positioning for the offshore, positioning is sufficiently accurate that



different surveys should result in no practical discrepancies in the positioning of grid areas.

- c. Under Section 14 of the Regulations, the ground positions of grid areas, permit areas, lease areas, sections, units, and wells are to be determined by reference to physical monuments. Now, GNSS positioning requires less reliance on physical monuments.
4. The following information is provided as an interim measure until the *Canada Oil and Gas Land Regulations* are updated.

### 11.2 Establishing Grid Areas, Sections, and Units

5. Sections 4 to 9 of the *Canada Oil and Gas Land Regulations* describe the land division system (consisting of grid areas, sections, and units) used for referencing surveys and oil and gas interests.
6. If no previous legal survey has been approved under the Regulations for the subject grid area, positions may be derived from control monuments or by GNSS observations.
7. Consultation with the Surveyor General Branch is required to determine if the grid area in which the surveyor is working has been established by a legal survey approved by the Surveyor General, and whether or not the surveyor will have to use control from the previous survey for new surveys within the same grid area.

### 11.3 Survey Methods

8. In addition to meeting the requirements specified in Sections 10 to 17 of the *Canada Oil and Gas Land Regulations*, surveys carried out under the Regulations must comply with the relevant provisions in *Chapter 1: Surveys* in the National Standards and the provisions in paragraphs 9 to 13 below.

#### **Geo-Referencing**

9. The survey must be geo-referenced in accordance with the requirements specified in *Chapter 1.9: Geo-Referencing* in the National Standards, with the following exceptions:
  - a. Land based absolute positioning requirements must be better than  $\pm 1$  metre at the 95% confidence level.
  - b. Seabed positioning accuracy requirements are dependent on the depth of the water and other environmental and equipment factors, and must be equal to or better than the minimum values for the subsea well or structure, at the 95% confidence level, specified in the following table:



**Table of Horizontal Uncertainty based on Well Type**

Absolute Positioning Accuracy				
Water Depth Range	0 to 250 metres	251 to 1000 metres	1001 to 2000 metres	2001 to 3000 metres
Exploration	± 2 metres	± 2 to 5 metres	± 5 to 10 metres	± 10 to 15 metres
Relative Positioning Accuracy				
Distance between Subsea Structures	Within 100 metres	101 to 250 metres	251 to 500 metres	501 to 1000 metres
Development, Production, Injection or Disposal	± 1 metre	± 1 to 3 metres	± 3 to 4 metres	± 4 to 6 metres

The surveyor shall use methods, procedures and equipment that will meet the accuracy standard and be satisfied that the survey would meet the standard. For absolute positioning the lower value in the accuracy range should be commensurate with a shallower depth. For the relative positioning the lower value in the accuracy range should be commensurate with the shortest distance between structures.

- c. To achieve the positioning accuracy requirements the following formulae should be used:

$$\sqrt{a^2 + (b * d)^2}$$

Where,

- a = constant depth error in metres
- b = factor of depth dependent error
- d = depth in metres for absolute positioning accuracy, or
- d = distance between structures in metres for relative positioning accuracy

The adopted “a” and “b” values shall be explained and justified in the Survey Report making sure to discuss all of the components of the subsea solution, including at least the following:

- i. the vessel surface positioning, heading, offset to rotary table, and roll and pitch;
- ii. environmental factors such as sea surface effects, excessive vessel motion causing cavitation and the speed of sound of the full water column;
- iii. acoustic positioning such as ultra short baseline systems (USBL) and long baseline systems (LBL); and





- iv. offset distance from the USBL transducer.

### ***Surveys on Land***

10. Where the purpose of the survey is to establish the position of a well on land, at least two monuments must be established near the well but in locations safe from damage that could result from development or other operations.
11. For monuments placed in positions other than at section or unit corners, each placed monument must be marked with the letter “C,” followed by a distinguishing serial number (e.g., C23, C34, C34A).
12. Survey connections must be made to permanent structures that may serve as permanent reference positions, such as well casings, wellhead equipment, or concrete foundations, and these positions must be described in the survey returns.

### ***Offshore Surveys***

13. For a subsea well (whether used for exploration, development, production, injection or disposal) the defined geo-referenced point must be the centre of the well bore encompassed in a blowout preventer or other device on the seabed. For subsea structures on the seabed geo-reference at least two (2) corners or other definable points (such as a machined slot with tight tolerances for the transponder or the centre of a transponder bucket). Include a sketch on the survey plan to show details of the subsea well or structure surveyed.

## **11.4 Plan Preparation**

14. A plan and field notes are required, and they may be combined (see Section 11.6: *Specimen Plans* below).

The plan and field notes must comply with the relevant provisions in Section 2.2: *Guidelines for Preparation of Survey Plans* and Chapter 3: *Field Notes* in the National Standards.

In addition, include the following:

- a. in the title block, the name assigned to a well or offshore structure, the unit, section, and grid area in which the well or offshore structure is located, and the licence number issued under the *Canada Oil and Gas Land Regulations*;
- b. the items required by Section 11 (2) of the *Canada Oil and Gas Land Regulations*;
- c. table showing geographic coordinates (latitude and longitude) and UTM coordinates in NAD27 of the corners of the grid area, of each unit involved, and of each well;
- d. table showing geographic coordinates (latitude and longitude) and UTM coordinates in NAD 27 and NAD83 (CSRS) [Canadian Spatial Reference System] of the well, of monuments (on land), and of permanent objects geo-referenced on the surface platform (in the offshore);



- e. for surveys on land, the ground elevation above sea level at the well;
- f. the perpendicular distances from the well or proposed well to the nearest unit boundaries; and
- g. for offshore surveys provide the water depth at the subsea well or structure referenced to CGVD2013 along with any other vertical datum relationships established during the survey, at the 95% confidence level, as specified in the following table:

Natural Resources Canada (NRCan) has released the Canadian Geodetic Vertical Datum of 2013 (CGVD2013), which is now the new reference standard for heights across Canada. This height reference system replaced the Canadian Geodetic Vertical Datum of 1928 (CGVD28).

**Table of Vertical Uncertainty based on Well Type**

Absolute Positioning Accuracy				
Water Depth Range	0 to 250 metres	251 to 1000 metres	1001 to 2000 metres	2001 to 3000 metres
Exploration	± 1 metre	± 1 to 3 metres	± 3 to 5 metres	± 5 to 8 metres
Relative Positioning Accuracy				
Distance between Subsea Structures	Within 100 metres	101 to 250 metres	251 to 500 metres	501 to 1000 metres
Development, Production, Injection or Disposal	± 1 to 2 metres	± 2 to 3 metres	± 3 to 4 metres	± 4 to 6 metres

The surveyor shall use methods, procedures and equipment that will meet the accuracy standard and be satisfied that the survey would meet the standard. For absolute positioning, the lower value in the accuracy range should be commensurate with a shallower depth. For the relative positioning the lower value in the accuracy range should be commensurate with the shortest distance between structures.

Although for offshore vertical transformations, there is typically a lack of sufficient gravity information to be certain of the geoid separation relationship, the values provided on the Natural Resources Canada website shall be used.

Link: [GPS-H](#)

(<https://webapp.geod.nrcan.gc.ca/geod/tools-outils/gpsh.php?locale=en>)

15. Because the land division system under the *Canada Oil and Gas Land Regulations* is referenced to NAD27, a Grid Converter Tool on the Natural Resources Canada



website is available for computing the NAD83 coordinates and surface areas for the corresponding NAD27 grid areas, sections, and units.

Link: [Oil and Gas Grid Converter](#)

(<https://clss.nrcan-rncan.gc.ca/clss/grid-grille/search-recherche/>)

### 11.5 Survey Returns

16. Submit the following survey returns:

- a. Plan of Survey; and
- b. Survey Report containing, in addition to the relevant requirements of *Chapter 4: Survey Reports* in the National Standards, the following information:
  - i. the method of determining coordinates of grid areas, sections, and units, and the position of wells and of new monuments;
  - ii. the method of determining the ground elevation for wells on land and determining the seabed or subsea well elevations for wells in the offshore;
  - iii. discussion of the maintenance and calibration of all equipment used to ensure the required accuracy is achieved, which for subsea wells shall also include the discussion of the installation and set-up; and
  - iv. discussion of the quality control and assurance measures used to ensure that accuracy standards and survey requirements are met.

17. Submit plans of survey for legal surveys north of the “Line of Administrative Convenience” (See Chapter 7 in the publication entitled [Getting a Survey Done](#) (<https://clss.nrcan-rncan.gc.ca/clss/surveystandards-normesdarcentage/gsd-frta>)) to the Surveyor General Branch in Edmonton for review and recording in the CLSR.

18. Submit plans of survey for legal surveys south of the “Line of Administrative Convenience” to the Surveyor General Branch in Ottawa for review and recording in the CLSR.

19. Pending amendment of the *Canada Oil and Gas Land Regulations*, as an interim measure, the Surveyor General will review but not approve survey plans prepared under these Regulations.

### 11.6 Specimen Plans

Available via the Natural Resources Canada website via Maps, tools and publications / Maps / Canada Lands Survey / For Canada Lands Surveyors / Survey Standards / Specimen Plans, at <https://clss.nrcan-rncan.gc.ca/clss/surveystandards-normesdarcentage/> for the following:

[#29 Plan of Survey of Oil and Gas Well \(Onshore\)](#)

[#30 Plan of Survey of Oil and Gas Well \(Offshore Platform\)](#)



## Chapter 12: OIL & GAS SURVEYS – YT

Chapter 12 is currently on hold.



## Chapter 13: MINERAL CLAIM SURVEYS – NORTHWEST TERRITORIES

### 13.1 Introduction

1. Legal Surveys are required to define boundaries of subsurface interest for lease purposes in the Northwest Territories.
2. Legal surveys may also be required to define the boundaries of dredging rights for lease purposes under the *Territorial Dredging Regulations*. Specific survey instructions are required for legal surveys under these Regulations.

On April 1, 2014, land and resource management responsibilities in the Northwest Territories were devolved to the Government of the Northwest Territories. The details of devolution are outlined in the '*Northwest Territories Lands and Resources Devolution Agreement*'. As outlined in this agreement, the government of the Northwest Territories assumed responsibility for the administration of mineral tenure in the Northwest Territories (Prior to April 1, 2014, the federal Department of Aboriginal Affairs and Northern Development was responsible for the administration of mineral tenure on behalf of the Government of Canada). Certain specific parcels of land were excluded from the devolution agreement and are listed in Schedule 4 of the Devolution Agreement - '*Inventory of Exclusions from Transfer of Administration and Control*'. The administration of mineral tenure on these lands was not transferred to the Government of the Northwest Territories and remains under the administration and control of the Government of Canada.

Effective April 1, 2014, the federal *Northwest Territories and Nunavut Mining Regulations* was repealed and replaced with the new federal *Northwest Territories Mining Regulations* and the new federal *Nunavut Mining Regulations*. The new federal *Northwest Territories Mining Regulations* apply to mineral tenure on all lands in the Northwest Territories that are managed by the Government of Canada. These lands are generally the lands listed in Schedule 4 of the Devolution Agreement.

The new territorial *Northwest Territories Lands Act* (S.N.W.T. 2014, c.13) and the new territorial *Mining Regulations* (R-015-2014) came into force on April 1, 2014. All specific requirements for prospecting, the staking and recording of mineral claims are outlined in the new territorial *Mining Regulations* (R-015-2014). The territorial *Mining Regulations* (R-015-2014) apply to all lands where the land and resource management responsibilities have been devolved to the Government of the Northwest Territories. This makes up the majority of the lands in the Northwest Territories.

The new territorial *Mining Regulations* (R-015-2014), substantially mirrors the new federal *Northwest Territories Mining Regulations*. However, these new regulations do differ from the previous *Northwest Territories Mining Regulations*.

3. The position of the boundaries of a mineral claim is governed by the legislation in force at the time that the claim was staked, and the legal survey of the claim must comply in every particular with the provisions of that legislation.
4. It is the surveyor's responsibility to gather all the information that is pertinent to the survey. A number of older but still active claims were staked under the former *Quartz Mining Regulations*. Therefore, to correctly survey the boundaries of a claim that was staked prior to November 15, 1977, the surveyor should be familiar with the Mining Regulations in effect on the date on which the claim was staked.



5. Chapter 13 of the National Standards uses the common term “staker” synonymously with the term “licensee” used in the current new federal *Northwest Territories Mining Regulations* and the new territorial *Mining Regulations* (R-015-2014).

### 13.2 Survey Methods

6. The following instructions apply to the survey of mineral claims staked between November 15, 1977 and March 31, 2014 under the *Northwest Territories and Nunavut Mining Regulations* and after March 31, 2014 under the new federal *Northwest Territories Mining Regulations* and the new territorial *Mining Regulations* (R-015-2014).
7. Any number of claims may be surveyed as one lot, provided that the aggregate area, as it appears in the application to record, does not exceed 2582.5 acres for claims staked between November 15, 1977 and March 31, 2014 and does not exceed 1250 ha for claims staked after March 31, 2014.
8. Chapters 1 to 5 of the National Standards apply to mineral claim surveys to the extent that their provisions are not inconsistent with the provisions of Chapter 13.
9. Every claim (or, in the case of a perimeter survey, every group of claims) to be surveyed is designated by a lot number that is issued with the survey instructions obtained from the regional office of the Surveyor General Branch. When applying for survey instructions, the surveyor must:
  - a. provide the claim names and record numbers;
  - b. identify the number of claims located in each 1:50,000 NTS quad and the number of lot numbers required in each, and
  - c. provide the best available information to position the claims on the NTS grid.
10. The boundaries of a mineral claim are defined by all the legal posts and boundary posts shown on the staker’s sketch as having been placed by the licensee. The staker’s sketch and *Application To Record a Mineral Claim* are the documents that the Mining Recorder has accepted as the claim, so substantive variations between what is shown on the staker’s sketch and what is found on the ground must be resolved in consultation with the Mining Recorder.

Differences between the evidence shown in official documents (*Application To Record a Mineral Claim*, staker’s sketch, previous surveys, etc.) and the evidence actually found and accepted must be addressed in a survey report.
11. Any number of adjoining claims may be surveyed as one lot, provided that the aggregate area, as it appears in the applications to record, does not exceed 1,250 ha. In this case, it is necessary to survey only those claim boundaries that form part of the perimeter of the lot or that are necessary to determine the position of any claim corner on this perimeter. It is the surveyor’s responsibility to ensure that no open ground exists between claims being surveyed as one lot.
12. The boundaries of a claim must be surveyed as straight lines joining the boundary posts placed by the licensee in staking the claim, provided that:



- a. the boundary of the claim is not defined by the natural boundary of a Land Claim parcel or a National Park; and
  - b. the surveyor excludes from the claim any overlapping prior claim in good standing at the time of staking.
13. The surveyor does not have the authority to declare a staker's intent to adjoin an adjacent surveyed claim when it is not clearly shown to adjoin that claim on the staker's sketch.

The surveyor should consult with the Mining Recorder to determine whether or not the claim boundary can be defined by the previously surveyed boundary of an 'adjacent' claim in cases where the boundary posts placed by the staker and found by the surveyor would otherwise create a gore.

14. A mineral claim includes all areas lying within its boundaries, including those covered by water. Survey connections to these water features are not required except as specified in paragraph 15 below.
15. In cases where a claim boundary has been located along the natural boundary of a Land Claim parcel or a National Park, and the natural boundary is intended to be the boundary of the claim, only those boundary posts along the natural boundary that define intersections of the claim boundary with the natural boundary need be located, surveyed, and monumented. The natural boundary segment between these intersections must be either surveyed or mapped.
16. Any overlapping prior claim in good standing must be excluded from the claim being surveyed. If the prior claim is unsurveyed, the boundaries of the prior claim must be determined to an extent sufficient to establish the boundaries common to both claims. This information is to be included in the field notes.
- If an overlapping prior claim divides the claim being surveyed into two or more separate areas, the surveyor must give notice to the Mining Recorder that the claim is comprised of more than one separate area of land.
17. If a previously surveyed claim was current at the time of staking and forms a common boundary with the claim being surveyed, the existing line must be retraced and a search made for evidence of the claim being surveyed. The retracement of the previous survey and all found evidence of the claim being surveyed must be incorporated into the field notes.
18. In a case where the line has been surveyed by the surveyor at some previous date, the line need not be surveyed again if a proper closure can be obtained without so doing. All new evidence and the information from the previous survey must be incorporated into the field notes, and dated accordingly.
19. In the case of a dispute, it is the surveyor's duty to note all adverse overlapping claims as they are found, to show them in the field notes and on the plan of survey, and to address the overlaps in the survey report. The surveyor has no authority to decide priority of rights.





20. In surveying a claim for which the extent is in dispute with another claim, the surveyor must identify on the plan all the intersections of the boundaries of the two claims. If the other claim is unsurveyed, its boundaries must be surveyed to an extent sufficient to determine the positions of the intersections and the full extent of the overlap.

### **Monuments**

21. Except as specified in paragraphs 22, 23 and 24 below, a monument must be placed:
- a. for each boundary post and witness boundary post shown on the staker's sketch as having been placed by the staker to define the boundaries of the claim, or in the case of a perimeter survey, those claim boundaries that constitute the perimeter;
  - b. at every intersection of the surveyed claim boundaries with the boundaries of overlapping prior claims;
  - c. at each boundary post and witness boundary post of the overlapping prior claim used in the determination of the intersection in (b) above; and
  - d. at every intersection of the claim boundary with the boundary of land on which the adjacent mineral rights are held by a third party, such as an entity of land claim beneficiaries.
22. In cases such as those where boundary posts have been placed along the natural boundary of a Land Claim parcel or a National Park, monuments are not to be placed at those boundary posts marking the natural boundary except as specified above in paragraphs 15 and 21 (d).
23. A monument must be placed where the legal post or witness legal post is found.
24. Where it is determined that the location called for by a witness legal post falls on dry land, a monument must also be placed at the location defined by the witness legal post.
25. When the legal or boundary post of the claim being surveyed is found at a monument previously erected during the survey of an adjoining claim, the surveyor must:
- a. accept the monument of the adjoining surveyed claim as that of the claim being surveyed;
  - b. read and record the existing monument markings; and
  - c. add inscriptions to the monument already set, if possible.
26. Where, as a result of Section 52 of the *Northwest Territories Mining Regulations* or the *Nunavut Mining Regulations*, the surveyor is directed by the holder to reduce a claim, a new legal post must be established pursuant to Section 23 of the Regulations to mark the new corner of the claim. The cut-off line must be monumented at intervals not exceeding 500 metres.
27. These monuments must be used to demarcate the boundaries of a mineral claim:
- a. a CLS post as described in *Section 1.2: Types of Monuments* in the National Standards;





- b. a mild steel bar not less than 1.5 cm square and 75 cm long driven into the ground so that no more than a 15 cm portion protrudes above ground level; or
  - c. a mild steel bar not less than 1.5 cm square and not less than 23 cm long cemented in rock so that no more than a 15 cm portion protrudes above ground level.
28. Ancillary monuments must be placed at each monument that defines the boundary of the claim being surveyed in accordance with *Section 1.4: Ancillary Monumentation* in the National Standards.  
  
Do not place ancillary monuments at monuments that are not on the boundary being surveyed—i.e., monuments placed to mark claim overlaps or in accordance with paragraph 20 (c) above.
29. All monuments marking the boundaries of a claim or a group of claims must be numbered consecutively, clockwise, beginning if possible at the northeasterly corner.  
  
The inscription must be in the form (*monument #*) *L* (*lot #*) — e.g., 1L1002.
30. Monuments placed at witness legal posts must also be marked “WT” with the distance and cardinal direction to the corner.

### 13.3 Field Note Preparation

31. Prepare field notes in one of the forms prescribed in *Chapter 3: Field Notes* in the National Standards. Alternatively, field notes can be encompassed on the plan of survey under *Section 13.4: Plan Preparation* below, provided that the field note information does not clutter the plan.
32. In addition to the information prescribed in Chapter 3, provide:
  - a. the name of each mineral claim surveyed in the title; and
  - b. the inscriptions on all found boundary and legal posts and witness legal posts.
33. It is permissible to use the abbreviations BP for boundary post and WT for witness legal post without explanation.
34. When a witness monument has been installed where the staker has placed a witness legal post to designate an inaccessible corner of a claim, the witness bearing must be referenced to the astronomical meridian at the witness legal post.

### 13.4 Plan Preparation

35. Prepare a plan of survey in accordance with the specifications in *Chapter 2: Survey Plans* in the National Standards. The plan scale must not be less than 1:5,000 for fully surveyed claims containing less than 25 hectares, and not less than 1:10,000 for other mineral claim surveys.
36. Depict natural and man-made features in sufficient detail to assist with identification of the geographical positions of the claims. Describe the source of this information in the legend.



37. In addition to the information prescribed in Chapter 2, show:
- the name of each claim surveyed in the title;
  - all legal and boundary posts and witness legal posts involved in the survey of the claim being surveyed, with bearings and distances sufficient to correlate these to the boundaries surveyed, and any legal or boundary posts that are now not on the boundary because the claim has been reduced in area pursuant to Section 52 of the *Northwest Territories Mining Regulations*;
  - the name of the claim and claim tag number shown within the claim, together with the lot number and the area in hectares;
  - the inscriptions on all found boundary posts that are pertinent to the survey;
  - the acceptance of posts if markings are illegible;
  - the notation for the establishment of the location of any boundary posts not found (e.g., FNE NBP1 SIMPLE 1, EST); and
  - the claim name and tag number for all adjacent claims.
38. In the case of a perimeter survey of a group of claims, show:
- in a separate table on the plan (if not shown on the plan body) and not in the title, the name of each claim included in the group and its tag number; and
  - the name of each claim and its tag number adjoining the perimeter, written in its appropriate position next to the boundary of the group.

### 13.5 Survey Returns

39. Submit the following survey returns:
- Plan of Survey;
  - Field Notes of Survey (if not encompassed in the plan);
  - copy of the *Application To Record a Mineral Claim* and the accompanying staker's sketch for the claim being surveyed, along with copies of the applications and staker's sketches for all adjacent claims currently in place and for any other claim for which tag information appears on the plan;
  - any other pertinent information; and
  - any other items requested by the Surveyor General Branch.
40. Submit the plan in both DWG and PDF format acceptable to the Surveyor General Branch, and all other information in PDF format.

### 13.6 Specimen Plan

Link:

[#32 Plan of Survey of Mineral Claim in NT](#)

(<https://clss.nrcan-rncan.gc.ca/clss/surveystandards-normesdarcentage/>)



## Chapter 14: MINING SURVEYS – YUKON

### 14.1 Introduction

1. There are three types of mining surveys made in Yukon: surveys of mineral claims granted under the *Quartz Mining Act*; surveys of placer claims granted under the *Placer Mining Act*; and surveys of placer base lines under the *Placer Mining Act*. A fourth type, rarely if ever surveyed, includes surveys of leases under the *Dredging Regulations*.
2. The term “mineral claim” is used to describe claims staked and granted under the *Quartz Mining Act*, and the term “placer claim” is used to describe claims staked and granted under the *Placer Mining Act*.
3. A mineral claim can overlap a placer claim. Mineral claims are granted for quartz (hard rock) mining of all types of minerals while placer claims are granted for placer mining of precious minerals (gold) or stones from gravel.
4. The *Placer Mining Act* uses the term “legal post” to describe the posts that are staked to mark the location of a placer claim. The *Quartz Mining Act* uses the terms “legal post” and “location post” to describe the posts that are staked to mark the location of a mineral claim. The term “legal post” shall be used for surveys of placer claims, and “location post” shall be used for the survey of quartz mineral claims.
5. Chapter 14 of the *National Standards* applies to the three types of mining surveys stated in paragraph 1.
6. Chapters 1 to 4 of the *National Standards* apply to mining surveys to the extent that their provisions are not inconsistent with the provisions of Chapter 14.
7. Specific survey instructions are required for all mining surveys. Every surveyed claim is designated by a lot number. When applying for specific instructions, the surveyor must provide the names, record numbers, and quad in which the claim or claims are situated.
8. Surveys of mineral claims and placer claims may be made to define the boundaries of the claims. Surveys of mineral claims are also required in order to apply for a quartz mining lease. Surveys of placer base lines are made to define the location of the base line.
9. Before submitting the plan to the Surveyor General Branch, the surveyor should obtain confirmation from the mining recorder that the surveyed claims comply with the legislation and policies that govern the staking and granting of claims, including: *Quartz Mining Act* Guidelines for Claim Staking and *Placer Mining Act* Guidelines for Claim Staking in Yukon, issued by Yukon Energy, Mines and Resources.

### 14.2 Claim Boundaries

10. The boundary position and dimensions of a mineral claim or placer claim are governed by the legislation in force at the time the claim was staked, and the survey must comply in every particular with that legislation.



11. No mineral claim or placer claim may consist of more than one parcel. Where a claim is separated by prior locations into two non-contiguous parcels, the parcel that adjoins or is closest to location post No. 1 must constitute the claim.
12. A claim includes all areas covered by water lying within its boundaries. The approximate location of islands, lakes, and water courses must be plotted on the survey plan using positioning, aerial photographs, or existing mapping. The ordinary high water mark of any water bodies close to a boundary being surveyed must be connected to and related to the boundary.
13. Every mineral claim is subject to reduction if, when the claim in question was staked, it encroached onto other prior mineral claims in good standing, or onto any other lands excluded from staking under section 15 of the *Quartz Mining Act*. Any overlapping prior mineral claim or section 15 lands must be excluded from the mineral claim being surveyed.
14. Every placer claim is subject to reduction if, when the claim in question was staked, it encroached onto other prior placer claims or prospecting leases in good standing. Any overlapping prior placer claim or prospecting lease must be excluded from the placer claim being surveyed.
15. Where an unsurveyed claim of prior location affects a claim under survey, the surveyor must survey the prior claim to an extent sufficient to determine the boundaries common to both claims. The surveyor must incorporate this data into the field notes, together with a copy of the application for the prior location.
16. In the case of a dispute, it is the duty of the surveyor to note all adverse overlapping claims as they are found, and to show them on the plan of survey. The surveyor has no authority to decide priority of rights.
17. In surveying a claim that is in dispute with another claim, the surveyor must record all the intersections of the boundaries of the two claims. If the other claim is unsurveyed, its boundaries must be surveyed to an extent sufficient to determine the positions of the intersections and the full extent of the overlap.

### **Monuments**

18. Use CLS 77 posts, CLS 77 rock posts, or CLS standard posts as described in section 1.2, Chapter 1, of the *National Standards* to demarcate Placer base lines.
19. Use any of the following types of monuments to mark the position of found location (legal) posts and to demarcate the boundaries of a mineral claim or placer claim:
  - a. a CLS 77 post, CLS 77 rock post or CLS standard post as described in section 1.2, Chapter 1, of the *National Standards*; or
  - b. a mild steel bar not less than 1.5 cm square and 75 cm long driven into the ground so that no more than a 10 cm portion protrudes above ground level; or



- c. a mild steel bar not less than 1.5 cm square and not less than 23 cm long cemented in rock so that no more than a 10 cm portion protrudes above ground level.
20. Unless otherwise provided in Chapter 14 of the *National Standards*, a monument must be placed, if possible, at each corner and deflection of the boundaries being surveyed. Intersections of boundaries defining subsurface rights with those defining surface rights need not be monumented, but the surface rights must be plotted on the plan.
21. A monument must be placed at all location (legal) posts that are used to define the claim being surveyed. Location (legal) posts of a claim constitute vital primary evidence and shall not be moved unless prior approval is granted by the mining recorder.
22. Where a location (legal) post or corner coincides with a monument established during the survey of an adjoining claim, the end point of the location line or corner being surveyed must be placed at the same point as the limit defining the adjoining surveyed claim.
23. If a corner or angle of a mineral claim or placer claim falls in an area covered by water or in any other locality unfavourable for the placing of a monument, it must be established by a witness monument placed on the boundary.
24. Where the witness monument replaces a witness location post, it must be placed at the same point as the witness location post or as near as possible on line between the No. 1 and No. 2 location posts.
25. Inscriptions on monuments must include the lot numbers and a distinguishing number. The inscription must be placed in the segment of the cap facing the claim for capped posts, or on the side of the post facing the claim for other posts. This inscription must be in the form (post#) L (quad lot#) — e.g., 3L1642.
26. The provisions in *Section 1.4: Ancillary Monumentation* of Chapter 1 in the *National Standards* apply to surveys of claims to the extent that they are not inconsistent with the provisions of Chapter 14. Where any two monuments marking a boundary line are less than 100 m apart, ancillary monumentation is to be established at only one of these monuments.
27. Where a group of adjoining mineral claims belong to the same owner, monumentation of internal corners may be omitted if such monumentation is impractical or is likely to be destroyed, but all claim corners on the perimeter of the group and all location posts defining the group must be monumented.
28. Cut out and blaze all perimeter boundaries of a group of adjoining mineral claims being surveyed. In addition cut out and blaze any surveyed interior boundary that separates mineral claims under different ownership.
29. When surveying a base line under the *Placer Mining Act*, monument the base line at the terminal and deflection points and at intervals not exceeding one kilometre. Mark monuments along the base line with the letters “BL” and identifying station numbers. A marker post shall be placed at each base line monument.



30. In addition to monumenting the base line itself, place reference posts at base line deflections and terminal points in locations where they are least likely to be destroyed. To reduce the possibility that stakers may mistake these reference posts for base line monuments, avoid making them overly conspicuous and identify them clearly with the letters “REF” and a unique number. A wooden stake should be placed at these reference posts rather than a marker post.

### 14.3 Placer Mining Surveys

#### ***Monuments***

31. Placer claims are usually located along a creek or river and are referenced to a base line established by official survey. A base line usually consists of a series of segments where points of deflection are identified by station numbers.
32. Many base lines are historic, having been surveyed and established at the beginning of the 20th century. A survey may be required to resurvey an existing base line or to establish a new one.
33. A base line is located along the general direction of the central bottom lands of a valley, but not necessarily in the centre thereof. The base line must conform as closely as possible to any existing unsurveyed base line shown on a placer claim sheet available from the mining recorder.
34. Large deflections should be avoided as much as possible so that claims will not depart too much from rectangular. In addition, the location of the unsurveyed base line and any placer claims shown on a placer claim sheet must be considered so that the survey does not significantly change their location, shape and size. For a creek, the base line should be near enough to the stream to ensure that all creek claim locations include the full width of the creek. For a river, the base line on each bank shall follow the general trend of the bank, and should be within 50 m of the bank on the upland side.

#### ***Placer Claim Configuration and Survey Methods***

35. Three kinds of placer claims are dealt with under the *Placer Mining Act*:
  - a. creek claims (those situated on a creek);
  - b. river claims (those fronting on a river); and
  - c. bench claims (those situated elsewhere).
36. Under the Act, a “river” is a stream with an average width of at least 45.7 m (150 feet). A claim fronting on a river is confined to one side of the river. The river bed cannot be included in a claim. (See figure 1).
37. Two legal posts are used to define the limits of a claim. The distance between them may not exceed 152.4 m (500 feet) in length along the base line except in the case of discovery claims, which are staked in accordance with Section 25 of the *Placer Mining Act*.



38. The length of the location line is measured on the base line for creek or river claims, and on the front line parallel to the base line for bench claims. In all cases, the claim boundaries must conform to the base line as surveyed.
39. The end boundaries of claims pass through the two legal posts at right angles to the base line (subject to the maximum allowable length along the base line).
40. The side boundaries of creek claims are parallel to the base line and 304.8 m (1,000 feet) on each side of the base line. (See figure 2)
41. The front boundary of a river claim follows the bank. The side (rear) boundary is parallel to the base line and 304.8 m (1,000 feet) from the base line.
42. A bench claim fronts on a line parallel to the base line lying either 304.8 m (1,000 feet), or a multiple thereof, distant from the base line. The side (rear) boundary is parallel to the front boundary and 304.8 m (1,000 feet) from the front boundary. Bench claims immediately adjoining the extremity of creek claims are known as Tier 1 bench claims, the next series of bench claims 1,000 feet further from the base line are known as Tier 2 bench claims, etc. As bench claims may be located on either side of a base line, the terms “right limit” and “left limit” are used for claims lying right and left of the base line for an observer looking downstream along the base line. A typical designation would be “Tier 2, Right Limit, Gold Run Creek”. (See figure 2)
43. Locate the base line and legal posts. Where the legal posts are not along the base line (or front boundary for bench claims), project their location onto the base line (or front boundary for bench claims) by lines at right angle thereto.
44. The length of a creek claim is measured along the base line. If the maximum length prescribed in paragraphs 37 and 38 above is exceeded, reduce it to the allowable length, measured along the base line and from the No. 1 legal post or its projection on the base line.
45. If a placer claim has been staked over length, the surveyor shall establish a monument at the No. 2 legal post and should not move No. 2 legal post when reducing the claim to the prescribed length.
46. There is no protection for gaps created during the staking of a group of placer claims where one or more of the claims have been staked longer than the permitted length measured along the base line. Over length areas (gaps) usually may only be acquired by staking the gap as a new claim. Alternatively, the owner of the group of claims may apply to the mining recorder for an extension of the claim boundaries pursuant to section 26 of the *Placer Mining Act*.

#### 14.4 Quartz Mining Surveys

##### ***Claim Configuration and Survey Methods***

47. The full size mineral claim is 457.2 m by 457.2 m (1,500 feet by 1,500 feet) and has a maximum area of 20.9 ha (51.65 acres).





48. A mineral claim is marked on the ground by two location posts erected at the ends of a location line. The maximum horizontal length of a mineral claim measured along the location line is 457.2 m (1,500 feet), or lessor distance determined by the position of the location posts.
49. The location line of a claim may form one of the sides of the claim, or a portion of the claim may lie on either side of the location line.
50. The markings on the No. 1 location post will indicate the distance the claim extends on either the left or right side of the location line (commonly called the throw), the total extent of which is not to exceed 457.2 m (1,500 feet).
51. Left and right sides of the location line are defined from the perspective of standing at the No. 1 location post and facing the No. 2 location post.
52. A fractional mineral claim is used to acquire ground lying between previously located mineral claims. Adjoining claims govern the configuration of the fractional claim. The maximum area of a fractional claim surveyed under Section 90 of the *Quartz Mining Act* is 24.3 ha (60 acres).
53. If location post No. 2 is more than 457.2 m (1,500 feet) from location post No. 1, or more than 804.7 m in the case of a location for iron or mica, the surveyor must place a monument on the location line at a distance of 457.2 m or 804.7 m, as the case may be, from location post No. 1, but should not disturb the original location post No. 2. A monument shall be placed at location post No.2 to preserve its position.
54. A claim staked as a fractional mineral claim may be surveyed to include as nearly as possible all the unoccupied ground lying between the previously located mineral claims described in the locator's application and accompanying sketch, provided that the area of the claim as surveyed is less than 24.3 ha (60 acres).
55. Where the plan of survey reveals significant differences between the staker's apparent intentions as reflected in the application and sketch and the final surveyed fraction, before submitting the plan to the Surveyor General Branch, the surveyor should seek the confirmation of the mining recorder that the fraction as surveyed complies with the *Quartz Mining Act*.
56. Section 89 of the *Quartz Mining Act* provides that where location post No. 1 or location post No. 2 of a mineral claim is on the boundary line of a previously located claim, and that boundary line is not at right angles to the said location line, the fraction so created may be included in the claim being surveyed, provided that it is available and open to disposal and provided that the claim including the fraction will not exceed 24.3 ha (60 acres). (See figure 3)
57. The fraction referenced in paragraph 56 above is understood to be the gore of unoccupied land that would result if the two claims were surveyed strictly rectangular to the location lines. This gore would be defined by joining the respective corners of the two rectangles by a straight line and not in any case by producing the sides of the rectangles.





58. Where both claims affected are being surveyed, and the fraction could be added to either claim without exceeding the limit of area or it could be divided between them, the circumstances in each case will indicate to the surveyor how the fraction should be dealt with, and the matter is left to the surveyor's discretion.
59. Section 14 (2) of the *Quartz Mining Act* deals with claims that are contiguous and comprise a group recorded in the name of one owner. (See figure 3):
- a. It covers the case in which a prospector stakes what is believed to be a solid row of claims, or parallel rows, and it happens inadvertently that the location lines of the contiguous claims do not form a straight line. In this case, the contiguity of the claims would not be disrupted, although fractions would be created. It is these fractions that are reserved to the recorded owner and that may on survey be included in a mineral claim under sections 14(2) and 89 of the Act. However, where the location line exceeds 457.2 m (1,500 feet) in length or the distance between parallel location lines exceeds the throw distances, the contiguity of the claim block is lost, the vacant ground lying between the claims is not a protected fraction under Section 14(2) of the Act, and it is available for staking by third parties; and
  - b. Under the portion of Section 14 (2) of the Act that reads "any such land may on survey be included in one or more of those claims by a Canada Lands Surveyor," the surveyor is allowed to include vacant fractions, created as described above in paragraph 59 (a), in either one or several adjoining claims, provided that the area of any of the claims does not exceed 24.3 ha (60 acres).

### **Location Line Surveys**

60. Where a location line survey is made strictly for the client's information and not for public use, the surveyor is not required to place monuments or file returns with the Surveyor General Branch.
61. If monuments are placed, Field Notes of Survey of Location Lines must be prepared and submitted in accordance with the provisions of Chapter 14 and *Chapter 3: Field Notes* in the National Standards.
62. Surveys of mineral claim location lines may be made to preserve and document the position and condition of location posts and to identify any open ground without surveying the boundaries of the claim.

These surveys do not define the boundaries of the claim, but may be used as field note information for a subsequent survey of the claim.

### **14.5 Field Note Preparation**

63. In addition to the information prescribed in *Chapter 3: Field Notes* in the *National Standards*, the following information is required in field notes of survey of mineral claim location lines, mineral claims or placer claims:
- a. in the title, the name of the claim and the name of the person(s) or company for whom the survey was made; and



- b. evidence of the position and condition of the found location or legal posts, the types of post, and the inscriptions and tags found on the posts. Photographs of the location or legal posts may be included with the survey report.
64. The abbreviations LP for location or legal post and WP for witness location post may be used without explanation.

#### 14.6 Plan Preparation

65. Placer claim and mineral claim survey plans must be prepared in accordance with *Chapter 2: Survey Plans* in the *National Standards*.
66. The plan must be similar in form to the specimen plans referenced in the *National Standards*.
67. Include in the title of the plan:
- a. the name of the claims, together with the lot and quad number;
  - b. the name of the person(s) or company for whom the survey was made; and
  - c. the mining district in which the claims are situated.
68. Show in the diagram of the plan:
- a. all location posts, legal posts, witness location posts, and location lines involved in the survey, with bearings and distances sufficient to correlate these to the boundaries surveyed, including any location (legal) posts that are now not on the boundary because the location line has been reduced in length pursuant to Section 24 (5) of the *Placer Mining Act* or Section 36 (1) of the *Quartz Mining Act*;
  - b. the name of the claim together with the lot and quad number and the area of the claim shown within the claim boundaries;
  - c. evidence of the position and condition of the found location or legal posts, the types of post, and the inscriptions and tags found on the posts (post#, claim name, tag#, length and direction, date, locator). This may be shown in table form or stated beside the appropriate monument. Photographs of the location or legal posts may be included with the survey report;
  - d. the name and general configuration of each claim adjoining the subject claim or group of claims; and
  - e. topographic features sketched in sufficient detail to assist with identification of the geographical positions of the claim or claims.

#### 14.7 Approvals and Certification

69. Place the appropriate endorsement certificates in the spaces indicated on the specimen plans referenced in the *National Standards*. For mineral claim surveys, the plan shall include the surveyor's certificate as required by section 93 of the *Quartz Mining Act*.



70. The owner, or the surveyor acting on behalf of the owner, must post and advertise mineral claim and placer claim surveys within six months of the completion of the field work and in accordance with the legislation.

Notice of surveys of placer mineral claims must be posted and advertised in accordance with Section 39 of the *Placer Mining Act*, and notice of surveys of quartz mineral claims must be posted and advertised in accordance with Section 70 or Section 87 of the *Quartz Mining Act*.

71. The surveyor must submit the final plan of survey of placer base lines to the Surveyor General Branch within six months of completing the field work. The Surveyor General Branch will make arrangements for the posting and advertisement of the survey of the base line.
72. The Minister of Energy, Mines and Resources, or person designated by the Minister, will approve a plan of survey of mineral claims, placer claims or placer base lines if the survey remains unopposed during the period of the advertisement.
73. Upon approval of a plan as specified above in paragraph 72, the Surveyor General, or a person designated by the Surveyor General, will confirm or approve the plan if the survey and plan conform to the National Standards and specific survey instructions of the Surveyor General. The plan will be deemed to be an Official Plan upon confirmation.
74. All field notes and plans of survey are recorded in the CLSR, and a copies of placer base line and placer claim surveys are sent to the Yukon Land Titles Office.

#### 14.8 Survey Returns

75. Submit the survey returns to the regional office of the Surveyor General Branch in Whitehorse within six months of completing the field work.
76. The survey returns must consist of:
- a. the Plan;
  - b. the Field Notes, if not included in the plan of survey;
  - c. copies of the applications, together with the accompanying sketches, for all surveyed and surrounding mineral claims;
  - d. a current copy of the claim sheet;
  - e. a priority/history table that lists the priority, according to the location dates, of the claims being surveyed and of any other claims that affect, or may affect, the boundaries of the claims being surveyed; the table must include the grant number, claim name, location date, recording date, any lapse date, direction of location line, and left and right throws from the location line;
  - f. a survey report, which may include photographs of the found location or legal posts; and
  - g. any other items requested in specific survey instructions for the survey.



## 14.9 Specimen Plans

*Links:*

[#33 Plan of Survey of Mineral Claim in Yukon](#)

[#34 Plan of Survey Base Line in Yukon](#)

(<https://clss.nrcan-rncan.gc.ca/clss/surveystandards-normesdarcentage/>)



FIGURE 1

### Placer Claims on a River

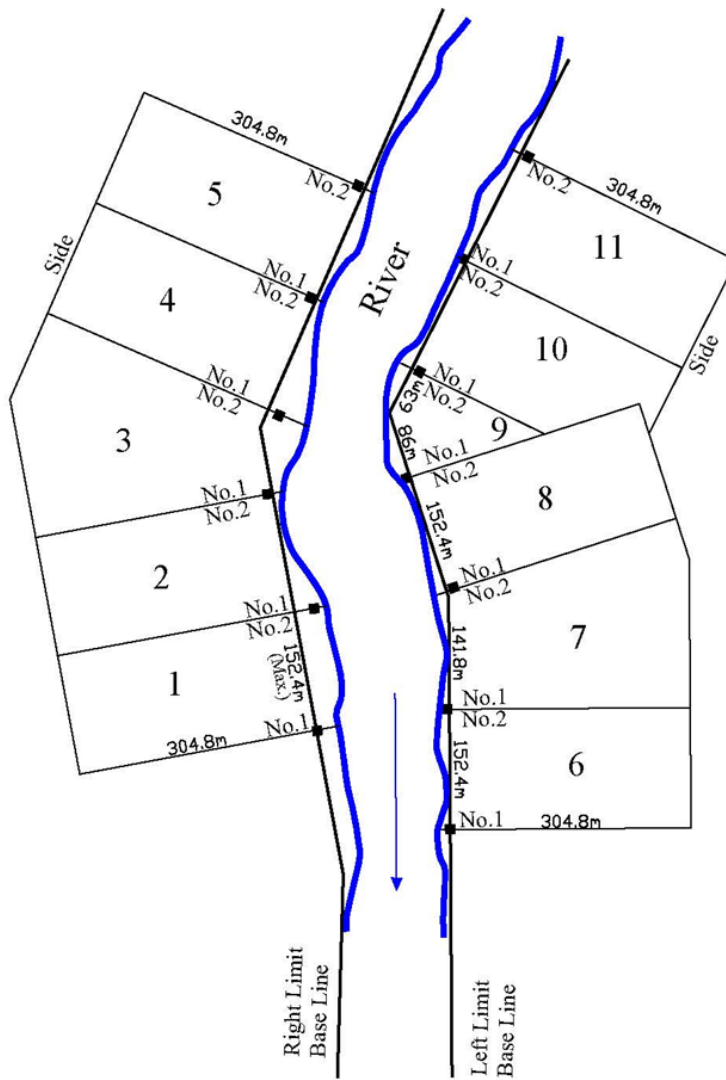

NOTE:  
All Claims front on the river bank  
Side boundaries are 304.8 metres from the baseline and parallel thereto

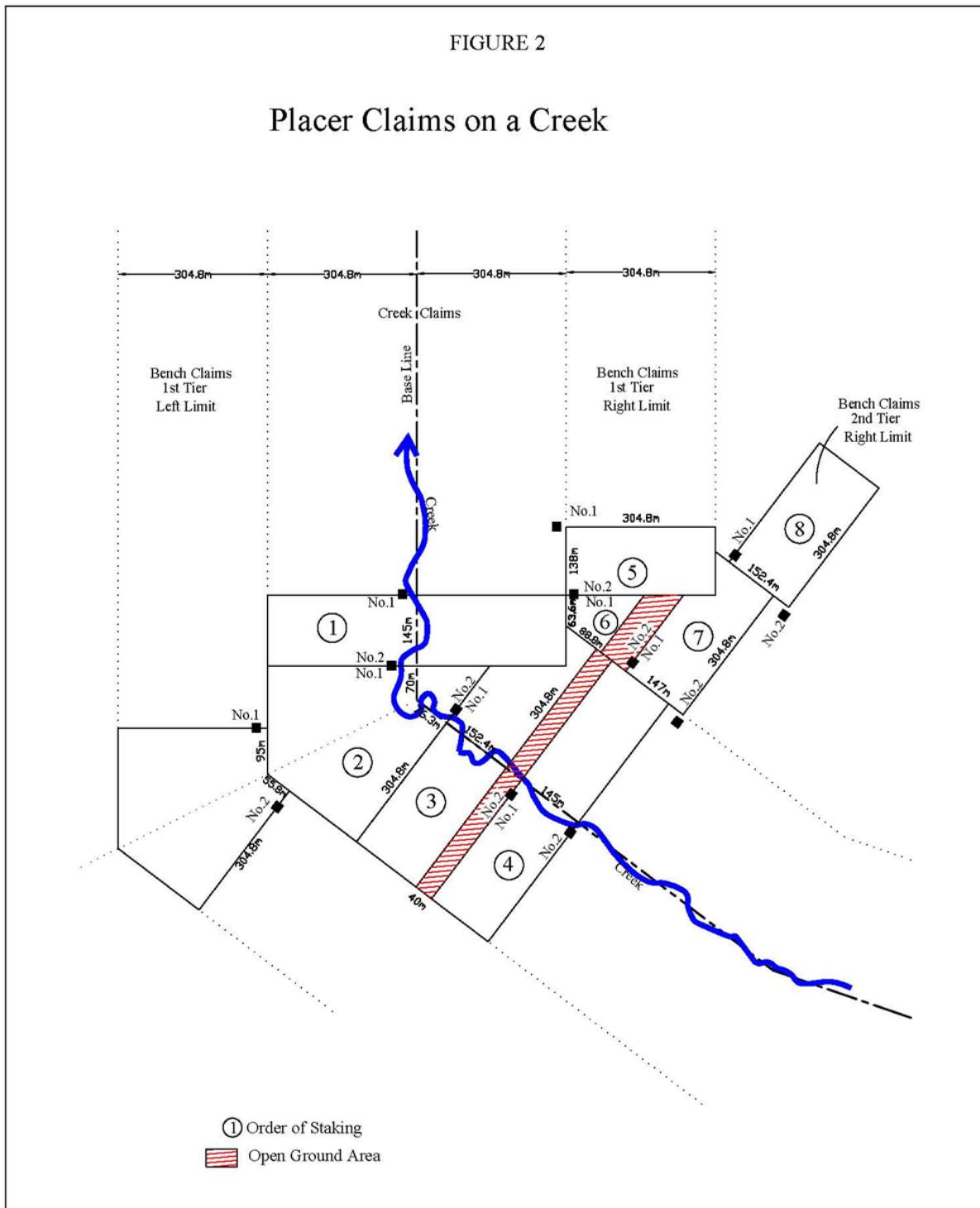
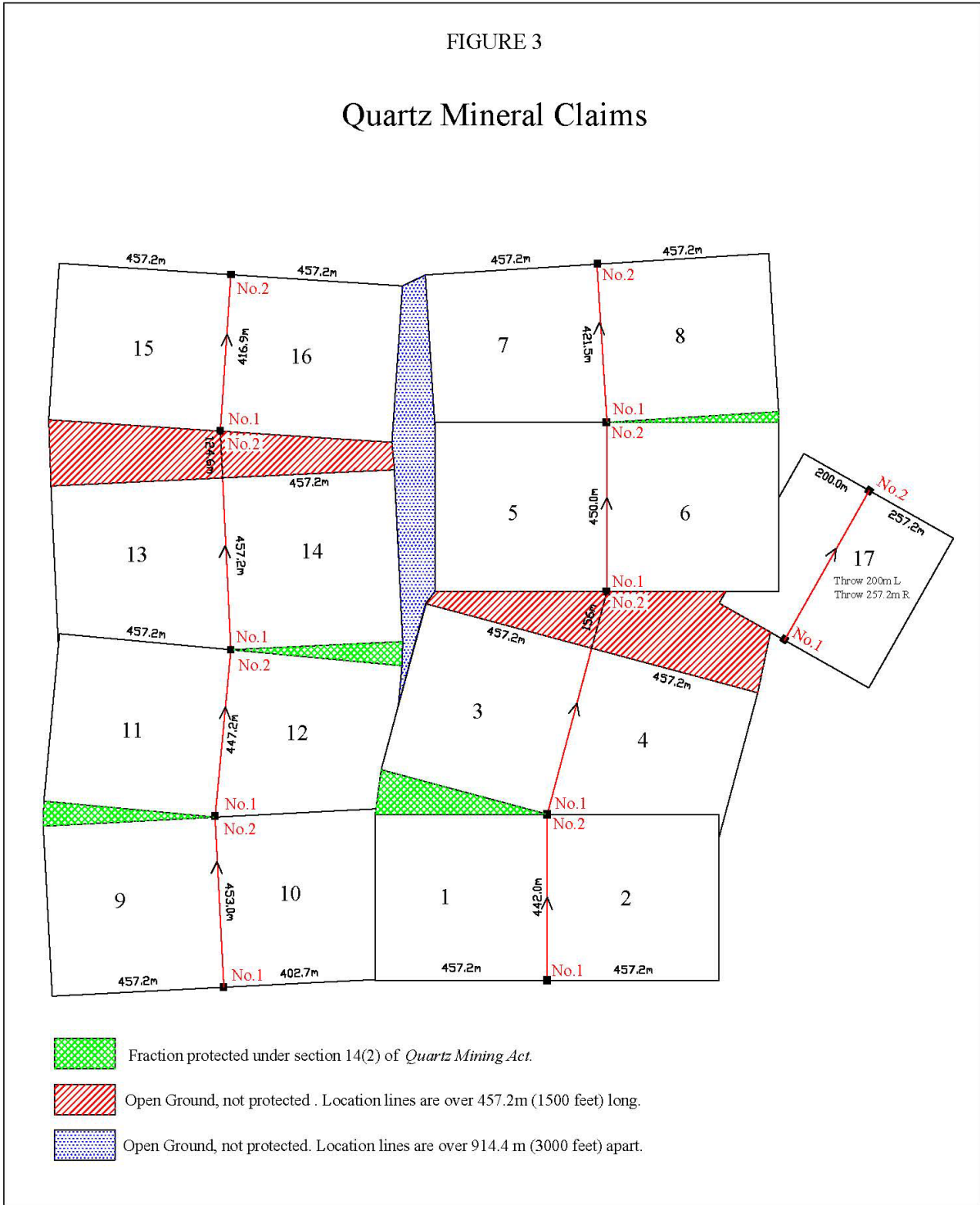



FIGURE 3

### Quartz Mineral Claims





## Chapter 15: MINING SURVEYS – NUNAVUT

### 15.1 Introduction

1. Legal Surveys are required to define the boundaries of mineral claims for lease purposes in Nunavut.
2. The position of the boundaries of a mineral claim is governed by the 2020 Nunavut Mining Regulations (Regulations amending the Nunavut Mining Regulations), pursuant to the Territorial Lands Act, that came into force on November 1, 2020.
3. Mineral rights in Nunavut are maintained through the [Nunavut Map Selection \(NMS\) system](#). This system allows for map selection of claims and lease renewals. A transition from existing ground staked claims to map-staked claims has occurred. The position of claims is determined by coordinates, rather than the legal posts on the ground.

### 15.2 Establishing Grid Areas, Sections and Units

4. Schedule 3, *Nunavut Lands Division*, of the 2020 *Nunavut Mining Regulations* defines the configuration of the grid areas, sections and units, which provides the digital boundary framework for the mineral claims.
5. Georeferenced grid, section and unit boundary line work is available to surveyors from the Surveyor General Branch. The calculations of the boundary line work provided by the Surveyor General Branch were done by first converting the four corners of each grid area from NAD27 to NAD83 using NTv2 ([National Transformation Version 2](#)) and then calculating all section and unit boundaries in NAD83.

### 15.3 Survey Methods

6. The following instructions apply to the survey of all mineral claims in Nunavut.
7. Chapters 1 to 3 of the *National Standards for Surveys of Canada Lands* apply to surveys performed under the requirements of this chapter, to the extent that their provisions are not inconsistent with the provisions of this chapter in which case this chapter takes priority.
8. Under specific Survey Instructions, it may be acceptable to compile mineral lease boundaries (see Chapter 2.7 of the National Standards).
9. The boundaries of a mineral claim are defined by coordinates as per the 2020 *Nunavut Mining Regulations*. The surveyed boundary of the claim is a realization of those coordinates and must follow the unit boundaries as defined in Schedule 3 of the said regulations, except for those boundaries described in section 17 below. If there is any discrepancy between a monument placed under this section and the theoretical position of a claim, priority must be given to the theoretical position of the claim.
10. In the east/west direction post along the geodesic and represent the geodesic line on the plan of survey and digital returns.





11. Legal posts, as defined in the previous, that have been placed on a claim prior to the coming in force date of the *2020 Nunavut Mining Regulations* do not need to be searched for and are no longer relevant.
12. The boundaries of active mineral leases issued before the *2020 Nunavut Mining Regulations* came into force will continue to be defined by the surveyed boundaries of that lease as long as it is still active. These boundaries will remain fixed and may not necessarily follow the Nunavut Land Division grid.
13. Claims may be from 1 to 100 units in size, however, map-staked units must be contiguous with another unit in that claim, and, the claim must not enclose a unit that is not comprised in that claim.
14. Lot designators for claims to be surveyed are issued with survey instructions obtained from the regional office of the *Surveyor General Branch*. When applying for survey instructions, the surveyor must:
  - a. Provide the claim names (if applicable) and record numbers;
  - b. Identify the number of claims located in each grid mapping area and the number of lot numbers required in each, and number of units; and
  - c. Provide a sketch of the claim(s) to be surveyed.
15. A mineral claim includes all areas lying within its boundaries, including those covered by water. Surveyed connections to these water features are not required except as specified in the paragraph 16 below.
16. In cases where a claim boundary has been located along the natural boundary of a park or an Indigenous Owned Land parcel, and this natural boundary is intended to be the boundary of the claim being surveyed, the natural boundary segment must be either surveyed or mapped to define the claim boundary in accordance with chapter 5 of the National Standards.
17. In cases where a claim boundary has been located along lands identified in Section 5 (Land Not Open for Prospecting) of the *2020 Nunavut Mining Regulations*, the boundary along those lands must be surveyed.

### **Monuments**

18. Monumentation must follow standards for *Monumentation of Parcels and Boundaries* as established in Chapter 1 of the National Standards. These monuments must be used to demarcate the boundaries of a mineral claim:
  - a. CLS post as described in Section 1.2 *Types of Monuments* in the National Standards;
  - b. a mild steel bar not less than 1.5 cm square and 75 cm long driven into the ground so that no more than a 15 cm portion protrudes above ground level;



- c. a mild steel bar not less than 1.5 cm square and not less than 23 cm long cemented in rock so that no more than a 15 cm portion protrudes above ground level;
  - d. additional types of monuments or modifications to monuments may be approved or specified by the Surveyor General based on the nature of the ground, the terrain, safety concerns, and local custom.
19. Ancillary monuments must be placed at each monument on the boundary of the claim being surveyed in accordance with Section 1.4 *Ancillary Monumentation* in the National Standards.
20. All monuments demarcating the boundaries of a claim or a group of claims must be marked in accordance with paragraph 7 in Section 1.3 *Monument Markings* in the National Standards.

#### 15.4 Plan Preparation

21. Prepare a plan of survey in accordance with the specifications in *Chapter 2: Survey Plans* in the National Standards.
22. In addition to the information prescribed in Chapter 2, show:
- a. In the Title Block or Legend:
    - i. the name of each claim surveyed in the title;
    - ii. below the plan title, show the name of the appropriate Grid Area of the survey;
    - iii. a description of how the Units, Sections and Grid areas are abbreviated (if applicable); and
    - iv. the statement “Unit corners are defined by Schedule 3 of the 2020 Nunavut Mining Regulations.”
  - b. In the plan body show:
    - i. a key plan showing surveyed Lot(s) and other surveyed lots in the Grid Area;
    - ii. unit identifiers for each unit for which the claim is comprised. Abbreviations are acceptable if they increase plan clarity, however the method of abbreviation must be clear, and explained in the legend;
    - iii. use the term “Part of” to describe Units not fully enclosed by the survey;
    - iv. area for the Inuit Owned Lands (IOL) parcel(s) within the surveyed lease boundaries must be shown in a table or in a statement;
    - v. adjacent unsurveyed active claims;
    - vi. ties to adjacent surveyed active leases and surface parcel boundaries where applicable; and



- vii. depict natural and man-made features in sufficient detail to assist with identification of the geographical positions of the claims. Describe the source of this information in the legend.

### ***Compiled Plan and Field Notes***

23. The use of compiled plans may be permitted in certain situations. For example, if new lot abuts a previously surveyed mineral lease issued prior to the *2020 Nunavut Mining Regulations* coming into force.
24. The surveyor must request permission from the Surveyor General Branch to compile when the request for survey instructions is made. Compiled plans must comply with Section 2.7 of the National Standards.

## **15.5 Survey Returns**

25. Submit the following survey returns:
  - a. Plan of Survey;
  - b. Field Notes of Survey (if not encompassed in the plan);
  - c. copy of the *Application to Record a Mineral Claim*;
  - d. any other pertinent information; and
  - e. any other items requested by the Surveyor General Branch.
26. Submit the plan in both DWG and PDF format acceptable to the Surveyor General Branch, and all other information in PDF format.

## **15.6 Specimen Plans**

Links:

[#35 Plan of Survey of Mineral Claim in NU](#)

[#36 Compiled Plan and Field Notes of Survey of Mineral Claim in NU](#)

(<https://clss.nrcan-rncan.gc.ca/clss/surveystandards-normesdarcentage/>)



## APPENDICES

### Appendix A: Glossary

This glossary defines surveying and related terms used in the *National Standards for the Survey of Canada Lands*. It is intended only to clarify how these terms are used with respect to Canada Lands, not to standardize terminology for national use.

Terms are arranged alphabetically, with the general term list first, followed by the more specific (e.g., *accuracy, absolute, accuracy, relative*).

<b>accuracy, absolute</b>	The degree of conformity of a measured or calculated position to its true (actual) position. For Canada Lands, absolute accuracy means the horizontal accuracy of coordinates for a point with respect to the North American Datum 1983 (Canadian Spatial Reference System) at a 95% confidence level. The absolute accuracy of any point depends on the absolute accuracy of the known point(s) used to derive the coordinates and the relative accuracy of the connecting measurement to the known point(s).
<b>accuracy, relative</b>	The degree of conformity of a measured or calculated position of a point relative to other points. For Canada Lands, relative accuracy means the horizontal accuracy between any two points on the survey where those points define or control the position of a boundary included as part of the survey.
<b>boundary, artificial</b>	A boundary defined by a straight line, a circular curve of known radius, or, in rare cases, a spiral curve.
<b>boundary, jurisdictional</b>	With regard to land, a boundary between two domains that have separate jurisdictions over land administration. For surveys of Canada Lands, jurisdictional boundaries include the boundaries of Indian Reserves, National Parks, and Settlement Lands in the territories. The boundary of a road vested in a province through an Indian Reserve or National Park is a jurisdictional boundary (see <i>Section 2.5: Highway, Railway, and Similar Right-of-Way Survey Plans</i> in the National Standards).
<b>boundary, natural</b>	A boundary defined by a natural feature, such as a water boundary, a watershed line, or a ridge line (see <i>Chapter 5: Water and Other Natural Boundaries</i> in the National Standards and “boundary, water” below).
<b>boundary, water</b>	A boundary of an upland parcel bounded by a body of water. It can be the water’s edge, the vegetation edge, the mean high water mark (MHWM), the ordinary high water mark



	(OHWM), the mean low water mark (MLWM), ad medium filum (amf).
<b>field notes</b>	Any field notes recorded in the Canada Lands Surveys Records.
<b>field records</b>	The raw data recorded in the field during the course of a survey.
<b>First Nation Lands</b>	A general term for land set aside for, owned by, or administered by a First Nation, including, but not limited to, First Nation Reserves.
<b>First Nation Reserve</b>	A term having the same meaning as “Indian reserve” has under the <i>Indian Act</i> .
<b>geo-referencing</b>	Determining the coordinates for a monument or point with respect to the NAD83 (CSRS) or alternative horizontal datum sanctioned in the specific survey instructions.
<b>geo-referenced control point (GCP)</b>	A point, which can be a monument, that has been geo-referenced to an absolute accuracy of 0.10 m or better at a 95% confidence level.
<b>lot</b>	Normally one of a series of parcels comprising a subdivision (or part of a subdivision) of a townsite, or one of a series of parcels within a block.
<b>marker</b>	A wooden, metal, plastic, or similar type of marker placed near a monument or on boundaries and used to protect and assist in locating monuments and boundaries.
<b>monument</b>	A monument as defined in Section 2 of the <i>Canada Lands Surveys Act</i> . It is a general term for some device, object, or thing that marks a surveyed boundary of land.
<b>monument, control survey</b>	A monument forming part of a provincial, federal, or other recognized survey control network. In a coordinated survey area established in accordance with Section 28 of the <i>Canada Lands Surveys Act</i> , control survey monuments are called coordinated control monuments.
<b>monument, disturbed</b>	A monument that has been moved by something or someone other than an authorized surveyor in the exercise of a professional duty, and that can be proven beyond doubt to have been moved from its original position.
<b>monument, lost</b>	A monument that cannot be restored with confidence from traces of the original monument remaining on the ground or



	from other physical evidence of the position of the original monument.
<b>monument, geo-referenced</b>	A monument that has been geo-referenced to an absolute accuracy of 0.10 m or better.
<b>monument, obliterated</b>	A monument that can be restored with confidence from traces of the original monument remaining on the ground or from other physical evidence of the position of the original monument.
<b>monument, witness</b>	A monument placed on a boundary of a parcel to witness the position of a point that cannot be monumented. The point is defined by the distance and direction from the witness monument, and can have only one witness monument defining its position.
<b>ordinary high water mark (OHWM)</b>	In non-tidal waters, is located where the presence and action of the water in normal conditions prevent the growth of terrestrial vegetation or mark the soil distinctively. In general terms, this is the back of the beach. In tidal waters, it is the line of mean high tide separating the upland parcel from the beach (or inter-tidal strip). The generally accepted surveying practice is that it is represented by a line of debris.
<b>parcel</b>	An area of land, usually surveyed, that is capable of being used to define the extent of land ownership or other exclusive use of land, such as certificates of possession in the case of First Nations Lands. It includes, but is not limited to, lots, blocks, sections, quarter sections, legal subdivisions, roads, highways, railway rights-of way, building units, condominium units, and air space parcels.
<b>parcel, parent</b>	The parcel within which air space or units are described by air space surveys, building units surveys, and condominiums surveys, or a parcel that is being subdivided.
<b>plan</b>	A plan that defines boundaries and parcels of land.
<b>Plan, Administrative</b>	A plan created for administrative purposes and prepared under Section 31 of the <i>Canada Lands Surveys Act</i> .
<b>Plan, Official</b>	A plan confirmed by the Surveyor General under Section 29 of the <i>Canada Lands Surveys Act</i> .
<b>Plan, Registration</b>	A term discontinued in 2014. Registration plans were formerly defined in the <i>Interdepartmental Agreement with the Department of Indian Affairs and Northern Development</i>



respecting land transactions on First Nation Reserves. Plans for this purpose are now prepared under Section 31 of the *Canada Lands Surveys Act* (see *Chapter 2: Survey Plans* in the National Standards).

**re-establish**

To determine the position of a lost or disturbed monument.

**restore**

To refurbish an obliterated monument to its original, or nearly original, condition. The field notes must explain what was done to restore a monument.

**resurvey**

A survey under Section 33 of the *Canada Lands Surveys Act* of a previously surveyed boundary for the purpose of correcting errors, re-establishing lost monuments, or placing additional monuments on the boundary.

**right-of-way**

A parcel, corridor, or other physical tract of land used for the passage of people, vehicles, or materials such as oil and gas, electricity, telecommunications, or water.

**survey, retracement**

A survey of a previously surveyed boundary in order to determine the directions and distances between the monuments marking it.



## Appendix B: Recommended Scales and Areas

1. Smaller scales (1:20,000 or 1:50,000) may be adequate for large, simple parcels.
2. Larger scale insets for detail may be used to achieve smaller overall plan scales.

<b>Table 1: Suggested Scales</b>	
<b>Parcel Size</b>	<b>Suggested Scale</b>
up to 1 hectare	1:1,000
1 to 2 hectares	1:2,000
2 to 10 hectares	1:5,000
over 10 hectares	1:10,000

<b>Table 2: Parcel Area Units</b>	
<b>Area of the Parcel</b>	<b>quote to:</b>
up to 0.1 hectares (1,000 m <sup>2</sup> )	1 m <sup>2</sup>
over 0.1 hectares to 1.0 hectares	0.001 ha
over 1.0 hectares to 10.0 hectares	0.01 ha
over 10.0 hectares to 100.0 hectares	0.1 ha
over 100 hectares	1 ha





### Appendix C: Recommended Symbology

1. All symbols for survey posts must be explained in the legend. If necessary, alternative symbols may be used.

Table 1: Recommended Symbols		
	Placed	Found
DLS or CLS standard post		
DLS or CLS standard rock post		
Old pattern iron post		
CLS 69 post		
CLS 77 post		
Control Survey Monument		
Geo-Referenced Control Point Monumented. (Show GCP beside the monument.)		
Geo-Referenced Control Point connected to a boundary monument (Describe the nature of the point.)		



2. The line symbology shown in *Table 2: Line Symbology* should be explained in the legend.

TABLE 2: Line Symbology	
Must be explained in legend.	
Lands or boundaries dealt with	 (0.8 – 1.0 mm)
Traverse lines and stations	 (0.25mm)

See also *Table 3: Line Symbology* in paragraph 3 below.

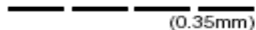

- 3. The line types shown in *Table 3: Line Symbology* should be used on plans and field notes but need not be explained in the legend.

<b>TABLE 3: Line Symbology</b>	
<b>Need not be explained in legend.</b>	
Lot or parcel boundaries within the lands dealt with and other measured boundaries	 (0.35mm)
Lot or parcel boundaries outside the lands dealt with	 (0.35mm)
Underlying lots or parcels	 (0.35mm)

See also *Table 2: Line Symbology* in paragraph 2 above.



## Appendix D: Abbreviations

1. *Table 1: Abbreviations* shows common abbreviations that may be used without explanation on plans and field notes.

Table 1: Abbreviations					
TERM	ENGLISH ABBREV.	FRENCH ABBREV.	TERM	ENGLISH ABBREV.	FRENCH ABBREV.
acre	A.	A.	Land Titles Office	LTO	LTO
approximately	approx.	approx.	meridian	M.	M.
azimuth	az.	az.	mound	M.	b. t.
boundary	bdy.	lim.	metre	m	m
block	Bk.	Bk.	square metre	m <sup>2</sup>	m <sup>2</sup>
bearing tree	BT	AD	magnetic	mag.	mag.
chord	c.	c.	mineral claim	M. C.	CM
calculated	(c)	(c)	made	Md.	fait
chord bearing	c.b.	d.c.	marked (markings found or placed posts may also be shown in italics, e.g. "16, R, 17")	Mkd.	mar.
check chained, or check measured	cc.	m.v.	marker post	Mkr.	bal.
coordinate control monument	CCM	CCM	monument	Mon.	Bor.
chain	ch.	ch.	North	N.	N.
centreline	☉	☉	number	No.	No.
Canada Lands Surveyor	CLS	ATC	National Historic Park	NHP	PHN
CLS capped iron post, 1969 pattern	CLS 69	ATC 69	National Historic Site	NHS	LHN
CLS post, 1977 pattern	CLS 77	ATC 77	National Park	NP	PN
Canada Lands Surveys Records	CLSR	AATC	National Topographic System (map sheet)	NTS	SNRC
Canada Lands Surveys System	CLSS	SATC	obliterated	oblit.	endom.
Certificate of Title	C. of T.	C. de T.	observation	obsn.	obsn.
post set in concrete	conc.	bét.	ordinary high water mark	OHWM	LHEO
centimetre	cm	cm	standard post (specify CLS, DLS, or provincial type)	P.	Bor. or Rep.
copied	(cop)	(cop.)	point of curvature	PC	PC
corner	cor.	coin	point of change of curvature	PCC	PCC
Coordinated Survey Area	CSA	CSA	point of intersection	PI	PI
diameter	diam.	diam.	4 pits	Pit.	Fos.
Dominion Land Surveyor, or Dominion Lands Survey	DLS	DLS	placed	Pl.	Pl.
East	E.	E.	polaris	Pol.	Pol.
found	Fd.	tr.	pipe post, (rock post in iron pipe)	Pp.	
found no evidence	FNE	r. tr.	Precise Point Positioning	PPP	PPP
fractional	Fr.	Fr.	rock post (specify CLS, DLS, or provincial type)	P. Rock	R. c.
foot or feet	ft. or '	pi or '	range	R.	Rg
Group (lot)	G.	G.	radius	R	R
Geo-referenced Control Point	GCP	PCG	re-established	Re-est.	réf.
Global Navigation Satellite System	GNSS	GNSS	remainder	Rem.	RE



**Appendix D: Abbreviations**

Global Positioning System	GPS	GPS	restored	Res.	res.
hectare	ha	ha	reference object	RO	OR
horizontal circle reading	HCR	MCA	Regional Surveyor Plan	RSP	RSP
highway	Hwy.	Rte	right-of-way	R/W	Emp.
old pattern iron post	I.	I.	railway	Ry.	c.f.
iron bar (specify size)	I. B.	R. f.	south	S.	S.
Indian (First Nation) Reserve	I. R.	RI	section	Sec.	Sec.
kilometre	km	km	sub-tangent	ST	ST
length of curve	L	L	station	Sta.	Sta.
Lot	L.	L.	township	Tp.	Tp.
latitude	Lat.	Lat.	trace	Tr.	Tra.
Links	Lk.	chon	Territorial Resource Base Mapping	TRBM	TRBM
longitude	Long.	Long.	traverse station	T. S.	s.c.
Land Registry Office	LRO	BE	West	W.	O.
legal subdivision	L. S.	s. o.	witness	Wt.	tém.



## Appendix E: Digital Spatial File Specifications

### Introduction

1. These specifications require the surveyor to prepare a digital spatial file.
2. These specifications apply to all surveys submitted for review except oil and gas wellsite surveys in the territories and offshore in cases where no parcel is surveyed.
3. Specimen digital spatial files are included as specimen plans in Chapters 2 and 3 and Chapters 5 to 14 of the National Standards, and are provided for guidance in preparing the digital spatial file.
4. The digital spatial file must be submitted via e-mail or Canada Lands Survey System (CLSS) On-Line, or on a medium acceptable to the Surveyor General Branch.
5. The digital spatial file format must be DXF or DWG:

<b>TABLE 1: Acceptable Versions of DXF/DWG for Digital Spatial File Returns</b>	
<b>DXF/DWG Version</b>	<i>AutoCAD versions</i>
DXF/DWG 2000 (AC1015)	AutoCAD 2000, AutoCAD 2000i, AutoCAD 2002
DXF/DWG 2004 (AC1018)	AutoCAD 2004, AutoCAD 2005, AutoCAD 2006
DXF/DWG 2007 (AC1021)	AutoCAD 2007, AutoCAD 2008, AutoCAD 2009
DXF/DWG 2010 (AC1024)	AutoCAD 2010, AutoCAD 2011, AutoCAD 2012
DXF/DWG 2010 (AC1027)	AutoCAD 2013, AutoCAD 2014, AutoCAD 2015, AutoCAD 2016, AutoCAD 2017

6. The digital spatial file name must be composed of the following elements:
  - a. the project number issued by the Surveyor General Branch, followed by the letters "SF";
  - b. if required, the checklist number to distinguish multiple digital spatial files submitted for one project; and
  - c. the file format extension (.DWG or .DXF).

Example:

*[Project number][SF][Checklist number].[DXF |DWG]*

200814003SF1.DWG



## Specifications

### ***Geo-Referencing***

7. The digital spatial file must be referred to NAD83 CSRS projected coordinates (e.g., NAD83 CSRS / UTM, NAD83 CSRS / MTM, or NAD83 CSRS / Double Stereographic projection applicable to the area of survey) or other approved coordinate system (e.g., ATS77/MTM for Nova Scotia).
8. The coordinates of the digital spatial file must be the same as those shown on the plan.

### ***Spatial Information***

9. The digital spatial file must be spatially correct and must represent the geometry shown on the plan.
10. All spatial distances in the digital spatial file must be GRID distances. The distances shown on the plan are normally ground distances.
11. All spatial bearings in the digital spatial file must be GRID bearings referred to the central meridian of the projection, where applicable.

### ***Layering***

12. *Table 2: Layer Names and Content* below lists the layer names and the specific content for each layer, followed by paragraphs describing how to use the layers.

Additional information such as title, lot numbers, etc. is not mandatory but may be included in the digital spatial file. This additional information must be stored on other layers, and the layer structure is left to the discretion of the surveyor.

<b>Table 2: Layer Names and Content</b>		
<b>Layer Name</b>	<b>Description</b>	<b>AutoCAD Object</b>
<b>CLSSBDRY</b>	All primary boundaries dealt with by the plan other than natural boundaries. See Section 13	line or arc
<b>CLSSSEC</b>	All secondary boundaries dealt with by the plan other than natural boundaries (e.g., easement). See Section 14	line or arc
<b>CLSSBDRYNAT</b>	All primary natural boundaries dealt with by the plan. See Section 15	polyline



<b>CLSSSECNAT</b>	All secondary natural boundaries dealing with easements and rights-of-way dealt with by the plan. See Section 16	polyline
<b>CLSSTIE</b>	All tie lines. See Section 17	line
<b>CLSSCONDOx</b>	All condo units, with each floor placed on a different layer. Each floor layer must be uniquely labelled CLSSCONDOx, where "x" is a unique integer for each floor. See Section 18	polyline, line or arc
<b>CLSSGCP</b>	All GCPs. See Section 19	3D point

13. **CLSSBDRY** contains the primary boundaries dealt with by the plan. If the purpose of the plan is to create new parcels, all boundaries except natural boundaries of the new parcels must be present on this layer. Similarly, if the purpose of the plan is to create only an easement, all boundaries of the easement other than the natural boundaries must be represented on the CLSSBDRY layer.
14. **CLSSSEC** contains all secondary boundaries dealt with by the plan. If the purpose of the plan is to create parcels as well as easements, the parcel boundaries must be represented on CLSSBDRY and the easement boundaries must be represented on CLSSSEC in order to avoid conflicts between the line works.

Information on the CLSSSEC layer should exist only if two or more types of boundary are dealt with by the plan. Only non-natural boundaries must be present on this layer.

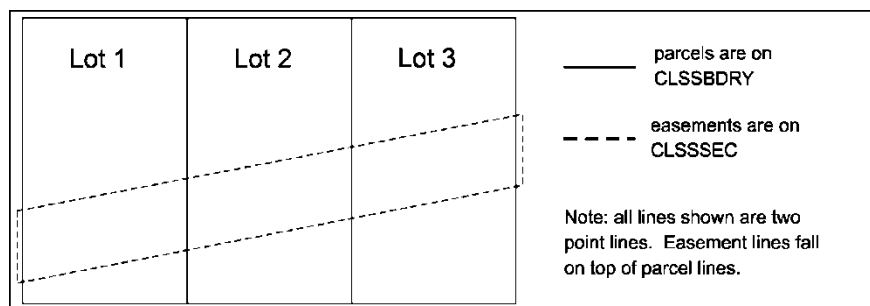

Figure 1

15. **CLSSBDRYNAT** contains all primary natural boundaries dealt with by the plan. If the purpose of the plan is to create new parcels, only the natural boundaries of these new parcels must be represented on the CLSSBDRYNAT layer. Only primary natural boundaries must be present on this layer.



16. **CLSSSECNAT** contains all secondary natural boundaries dealt with by the plan, such as natural boundaries of an easement. If the easement is bounded by a natural boundary, that segment of the easement must be on the CLSSSECNAT layer. Information on CLSSSECNAT should exist only if two or more types of natural boundaries are dealt with by the plan. Only secondary natural boundaries must be present on this layer.
17. **CLSSTIE** contains all the other measured boundaries and connections to survey monuments and nearby control survey markers. All tie lines on CLSSTIE must be shown in full length (i.e., if a tie is made to a control point 2 kilometres away, the line on CLSSTIE will be completely shown at its true length but it may be shown as broken on the plan.) Other traverse lines must not be shown on this layer.
18. **CLSSCONDO<sub>x</sub>** contains the boundaries of all condominium units. Each unit must form a closed polygon and all unit boundaries must be an accurate representation of the unit boundaries represented on the plan. Each unit must be spatially oriented relative to the parent parcel. The parent parcel is to be shown on the CLSSBDRY layer.  
  
For multi-floor condominiums, each floor must be placed on a separate layer in the digital file. Each floor layer must be uniquely labelled CLSSCONDO<sub>x</sub>, where “x” is a unique integer for each floor (e.g., “0” for basement, “1” for first floor, “2” for second floor, etc.). Common areas are not to be shown in the digital spatial file.
19. **CLSSGCP** contains the 3D point of each GCP placed or found to control the absolute position of the survey. The 3D point must be positioned using the northing, easting, and ellipsoid height of the GCP.
20. Line work in details must not be placed on the CLSSBDRY, CLSSBDRYNAT, CLSSSEC, CLSSSECNAT, CLSSTIE, CLSSCONDO<sub>x</sub>, or CLSSGCP layers. Line work on these layers must represent the main body of the plan, even if it is not visible at plotting scale.

### ***Topology and Structure***

21. All dimensioned boundaries and survey connections must be represented by lines.
22. All lines must be topologically correct on the layer itself, but not between layers. Natural boundary layers such as CLSSBDRYNAT and CLSSSECNAT must be topologically consistent with their corresponding CLSSBDRY or CLSSSEC layer.
23. The following rules are to be followed for each layer (unless otherwise indicated) to ensure properly structured data:
  - a. No duplicate lines:
    - i. within a particular layer,
    - ii. between CLSSBDRY and CLSSTIE, i.e. between any two points where a CLSSBDRY line exists, there shall be no corresponding CLSSTIE line, and
    - iii. between CLSSSEC and CLSSTIE, i.e. between any two points where a CLSSSEC line exists, there shall be no corresponding CLSSTIE line.
  - b. No overlapping lines within the same layer.





- c. No crossing lines on CLSSBDRY and CLSSBDRYNAT.
- d. No undershoots and overshoots (see Figures 2 and 3 below).
- e. At corners or intersections, all lines must converge to the same point. Avoid and correct situations in which a small triangle, a small gap, or a small line is created (see Figures 4, 5, and 6 below).
- f. The line types must be the following AutoCAD objects:
  - i. straight lines are to be of type LINE;
  - ii. curved lines are to be of type ARC; and
  - iii. natural features are to be of type POLYLINE.
- g. Each line of the same nature must be broken at monuments (no gaps), deflections, and intersections. Lines must not be broken at other points, such as traverse hubs.

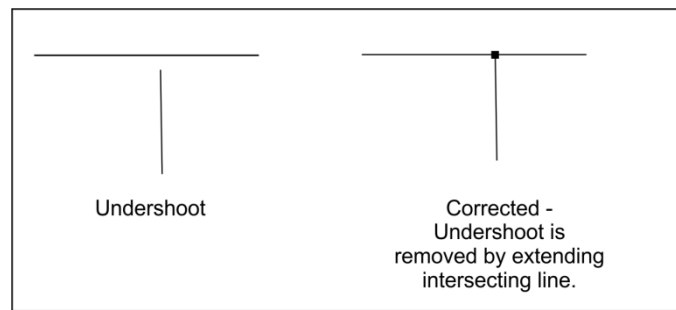

Figure 2

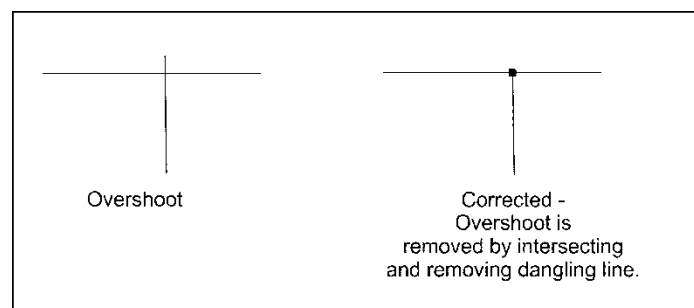

Figure 3

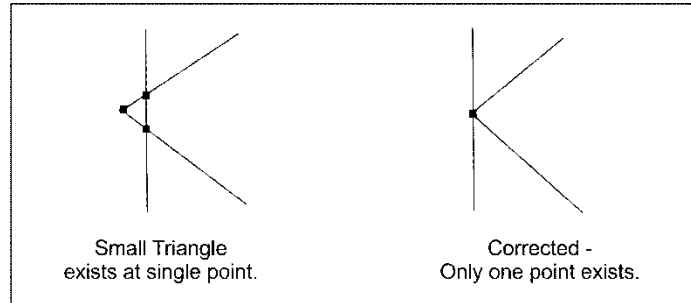

Figure 4

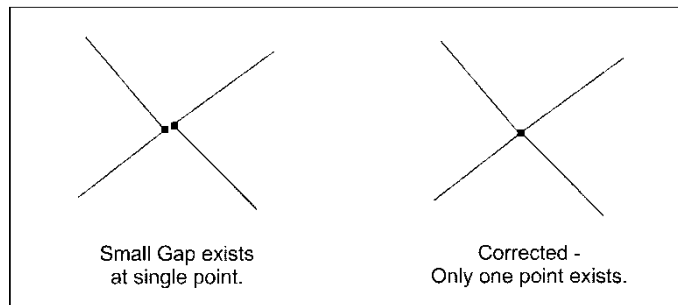

Figure 5

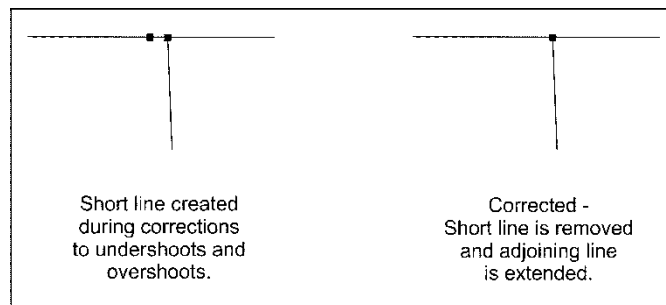

Figure 6

**Report**

24. If any additional information is required regarding the digital spatial file, submit it as part of the survey report (see *Chapter 4: Survey Reports* in the National Standards).