



Environment  
Canada

Environnement  
Canada

# ANALYSIS OF WATER CHEMISTRY DATA FOR 28 RIVERS IN ATLANTIC CANADA Appendices

IWD-AR-WQB-86-115



Dartmouth Env. Can. Lib./Bib.



39 038 274

Atlantic Regional Library  
Environnement Canada  
MAY 20 1987  
Bibliothèque de la région  
de l'Atlantique  
Environnement Canada

Canada

INLAND WATERS DIRECTORATE  
ATLANTIC REGION  
WATER QUALITY BRANCH  
MONCTON, NEW BRUNSWICK

Analysis of water chemistry data for 25 rivers...

TD  
227  
.A8  
A53  
App.

Appendix 1. Scatter plots of excess sulfate calculated by magnesium ratio for the study rivers.

River no 1 Excess SO4 Mg

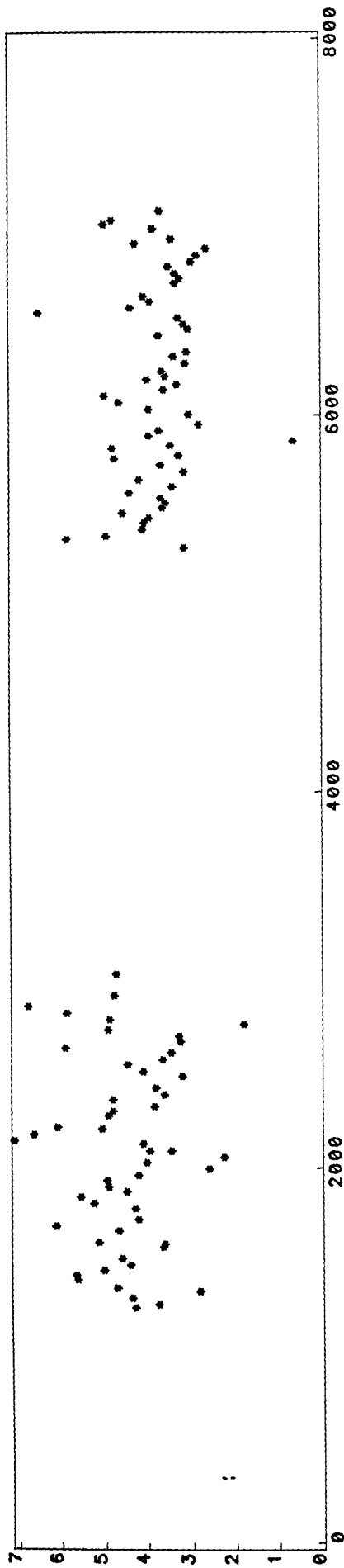

River no 2 Excess SO4 Mg

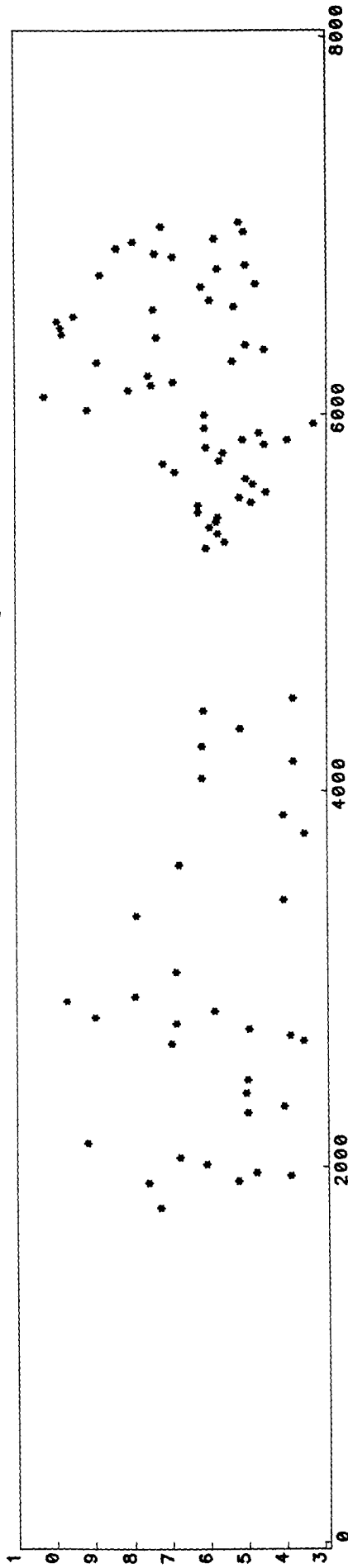

River no 3 Excess SO4 Mg

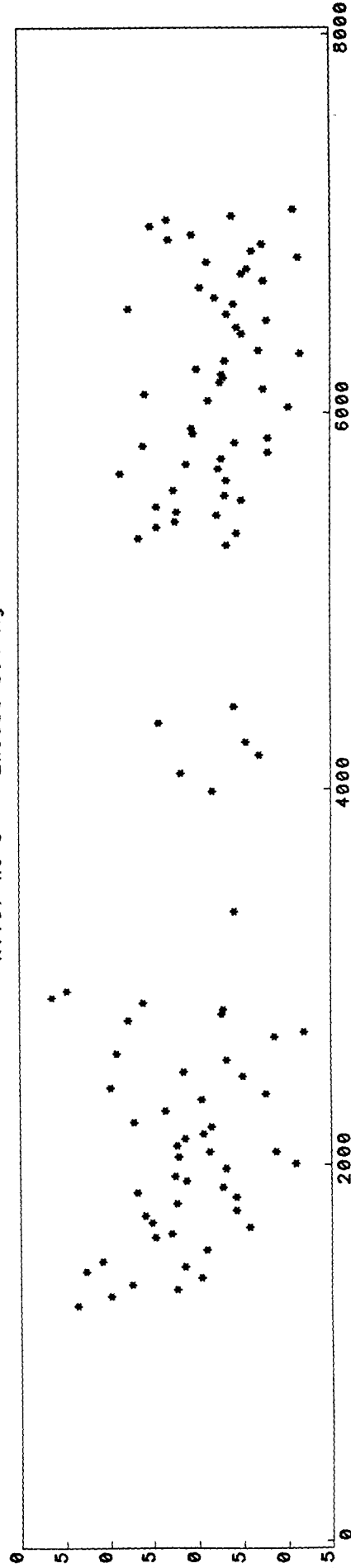

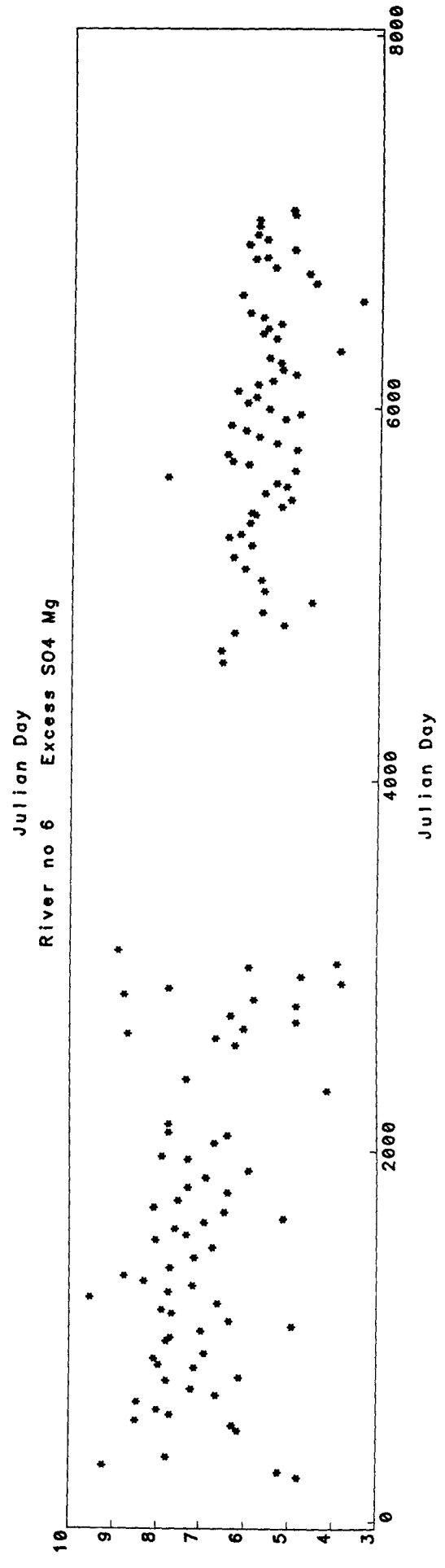
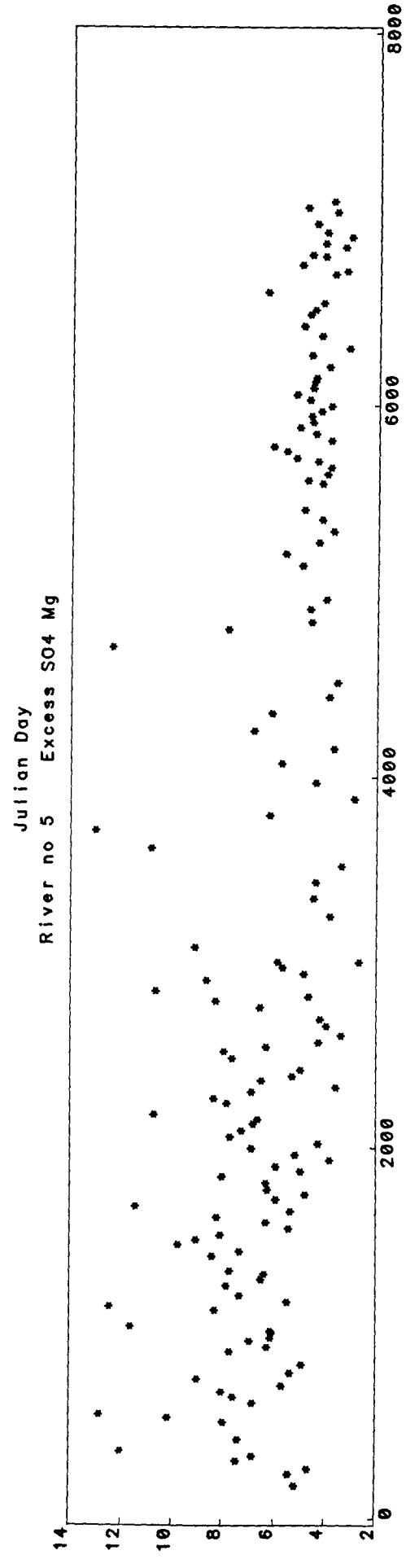
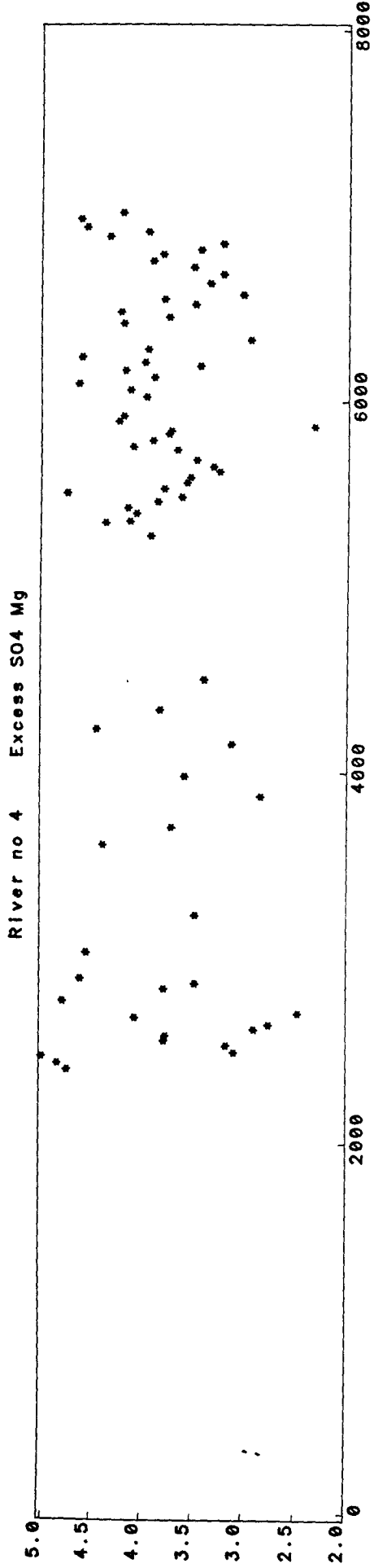

River no 7 Excess SO4 Mg

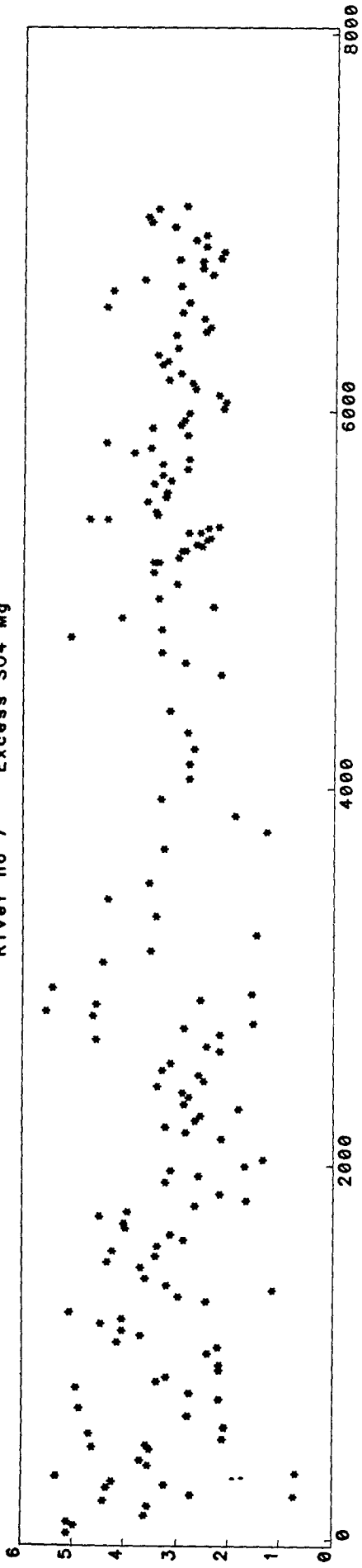

River no 8 Excess SO4 Mg

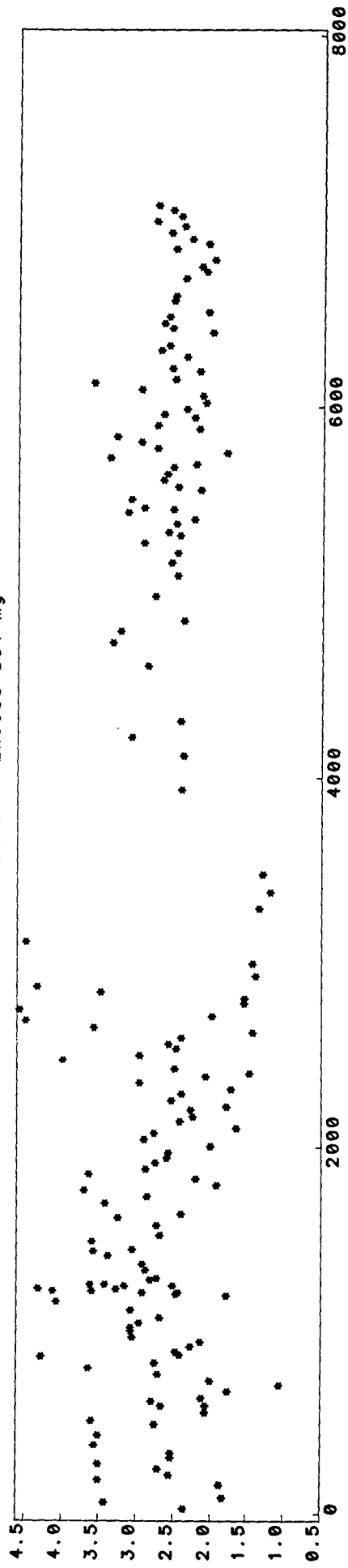

River no 9 Excess SO4 Mg

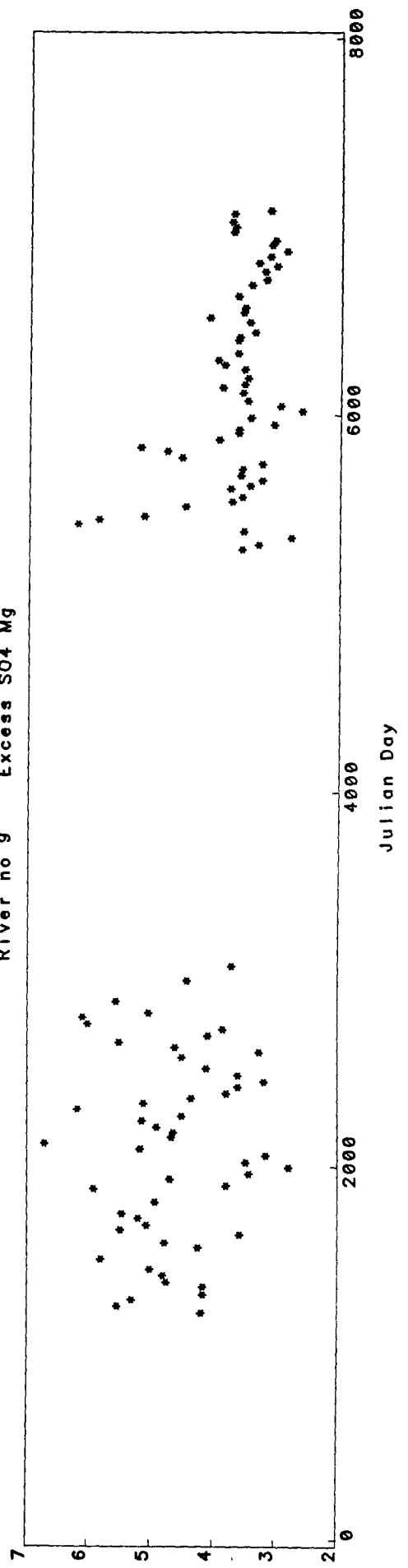

River no 10 Excess SO4 Mg

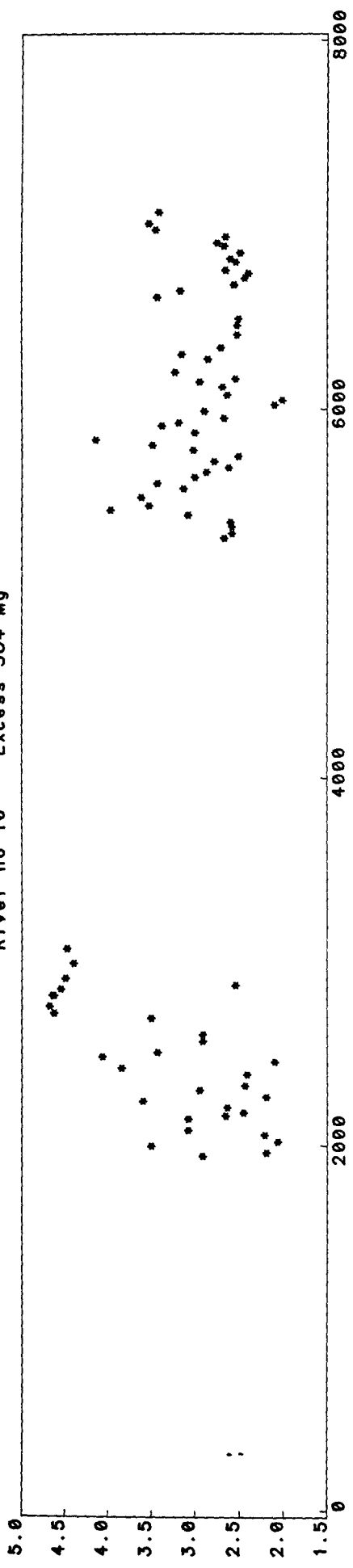

River no 11 Excess SO4 Mg

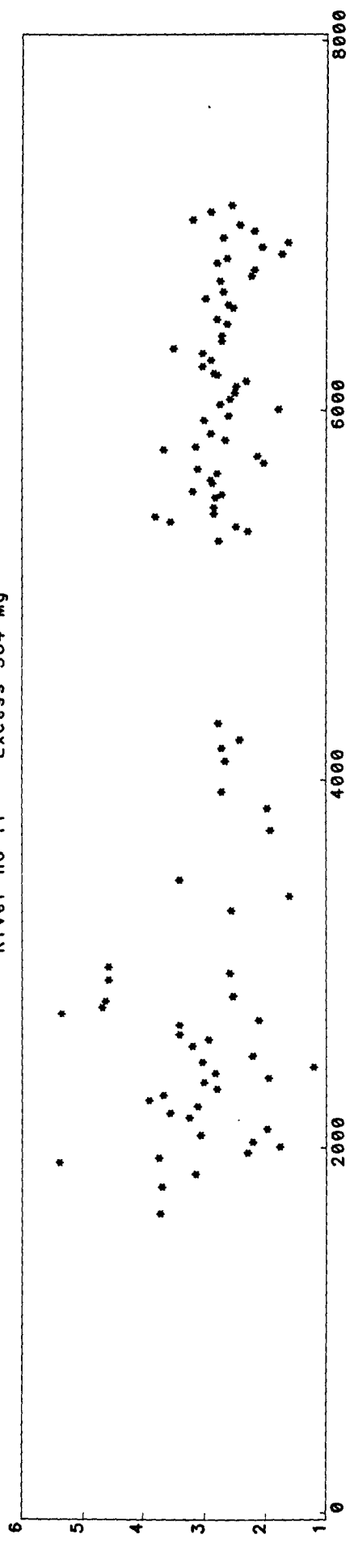

River no 12 Excess SO4 Mg

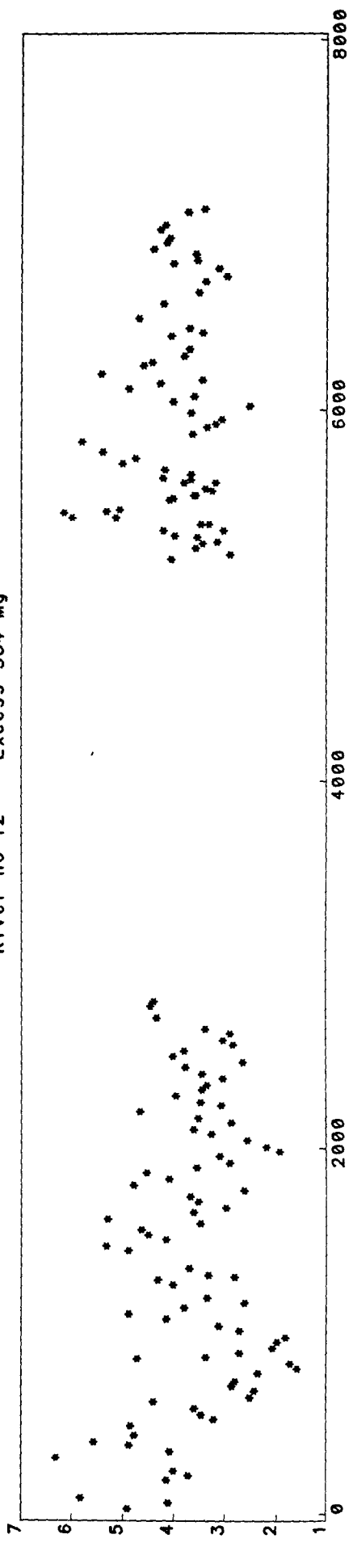

River no 13 Excess SO4 Mg

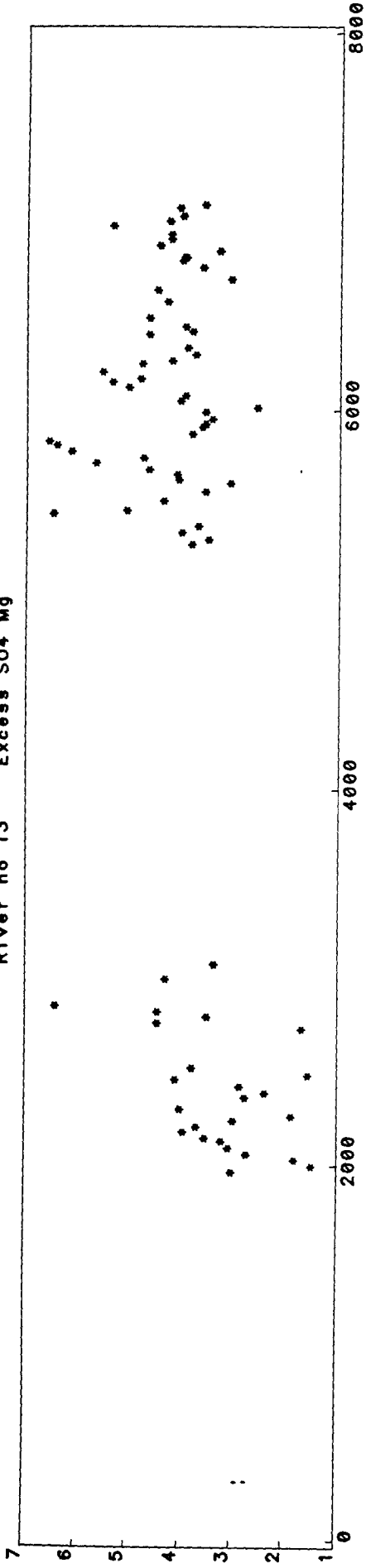

River no 16 Excess SO4 Mg

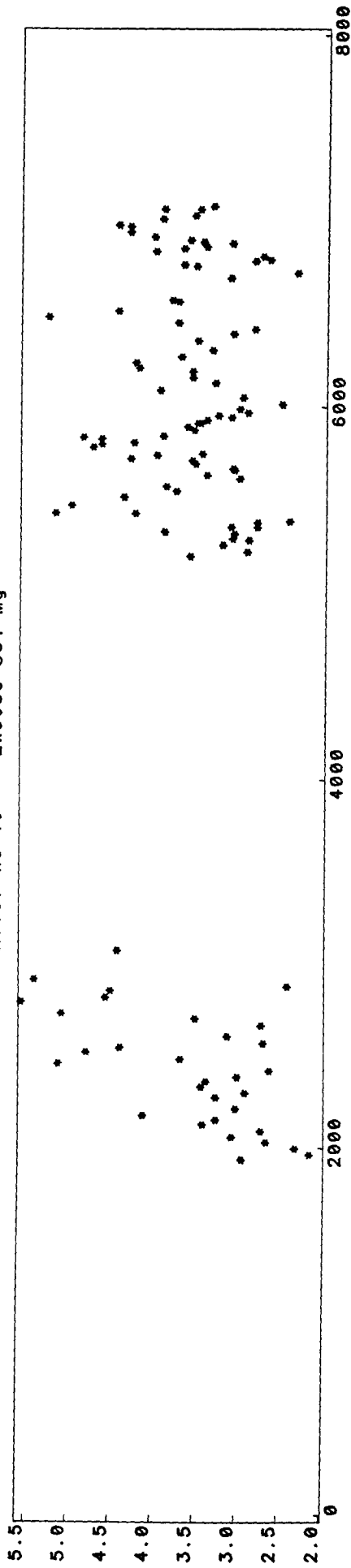

River no 17 Excess SO4 Mg

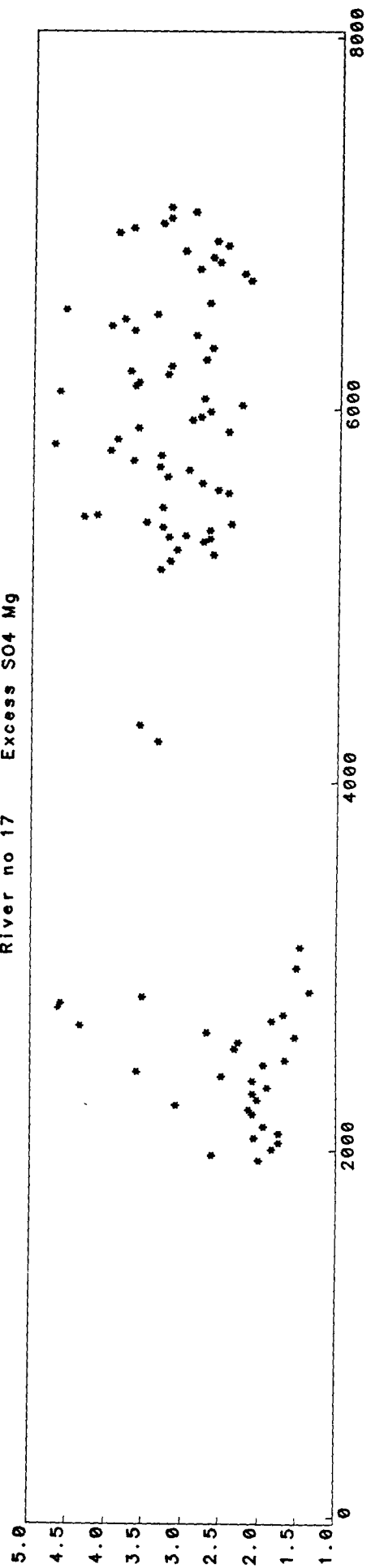

River no 18 Excess SO4 Mg

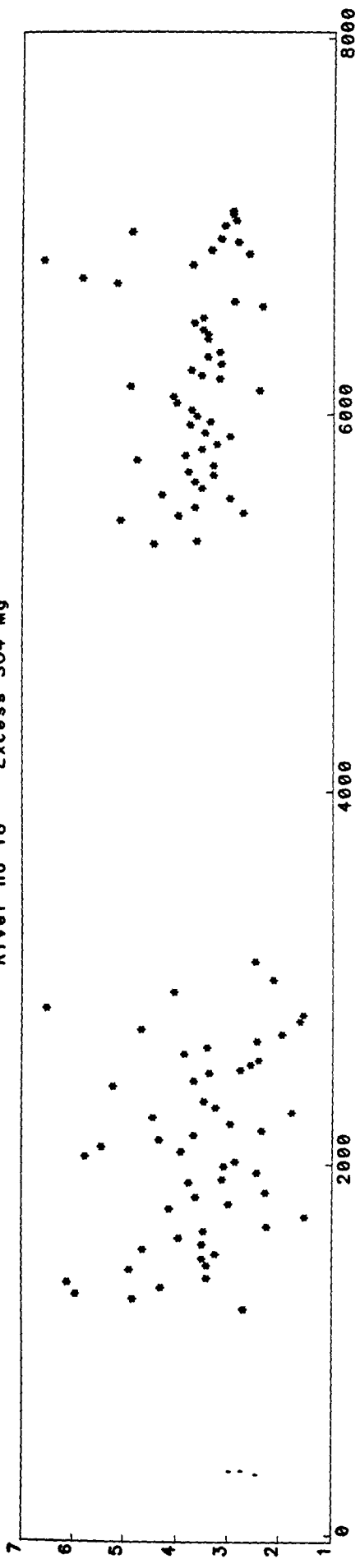

River no 19 Excess SO4 Mg

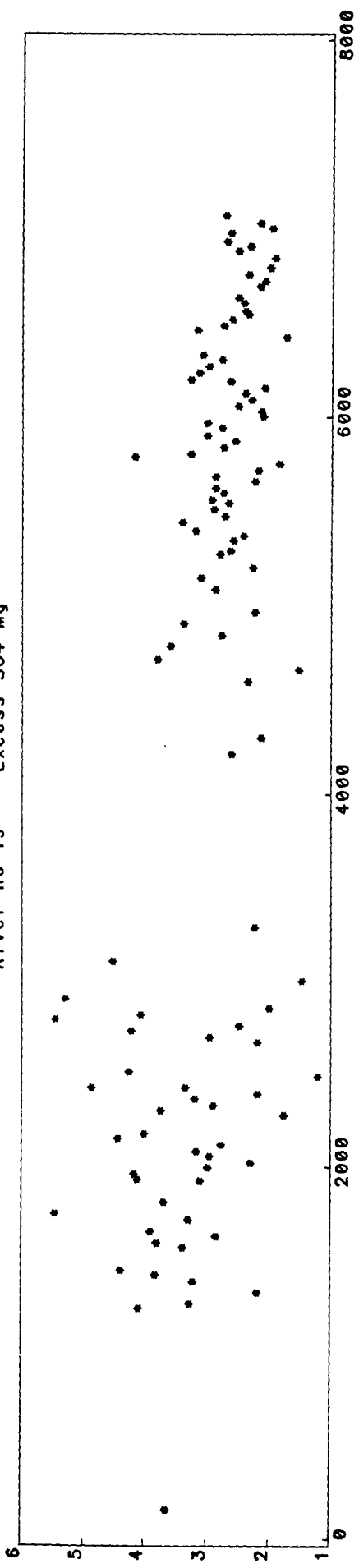

River no 20 Excess SO4 Mg

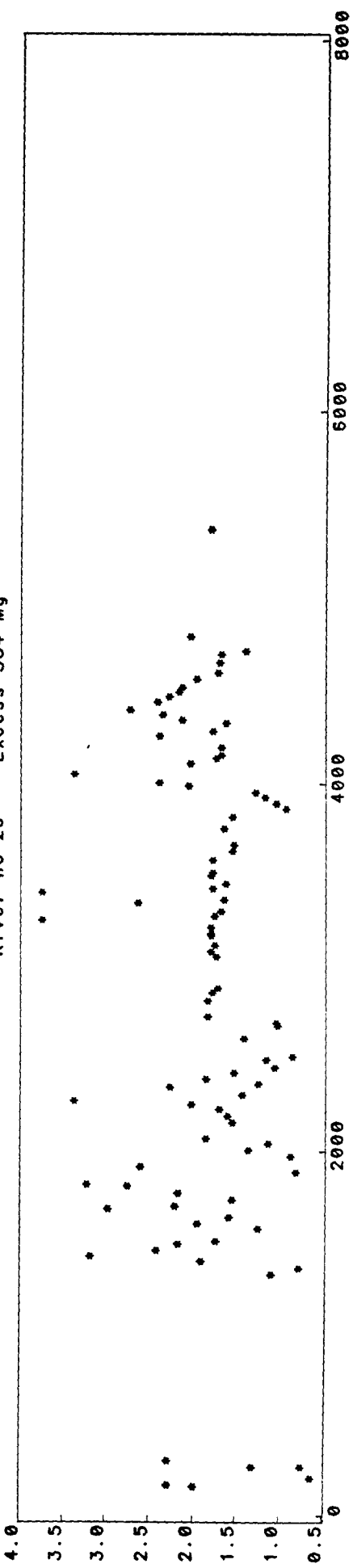



River no 21 Excess S04 Mg

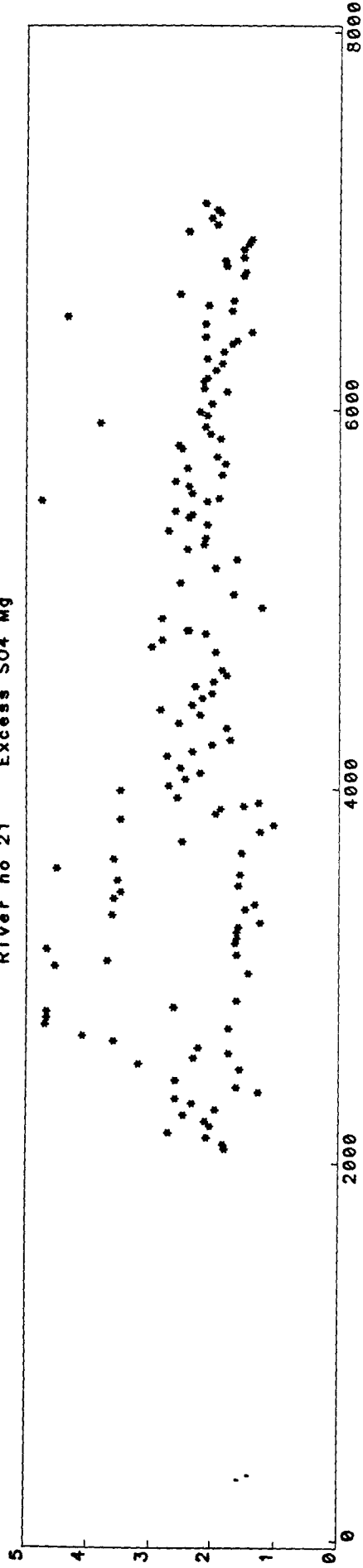

River no 22 Excess S04 Mg

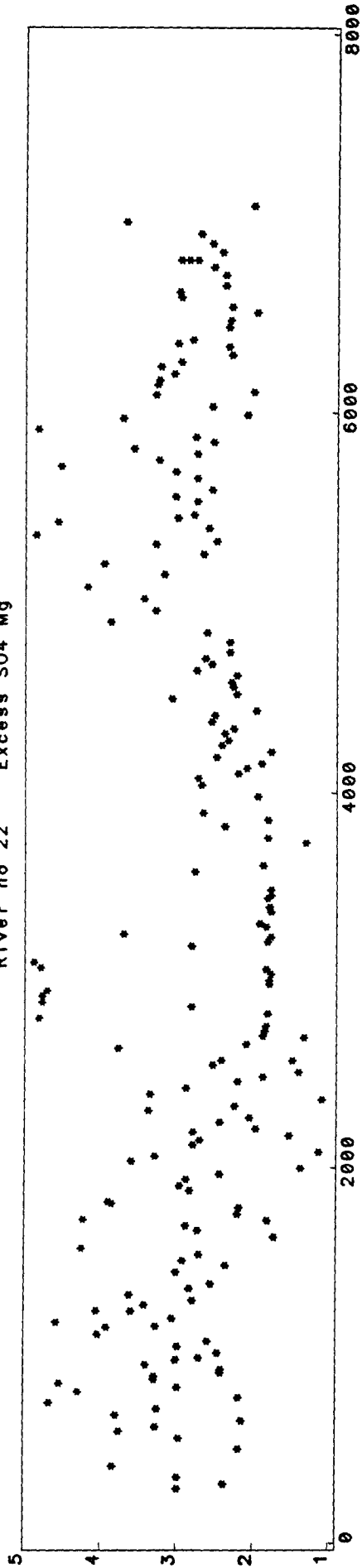

River no 23 Excess S04 Mg

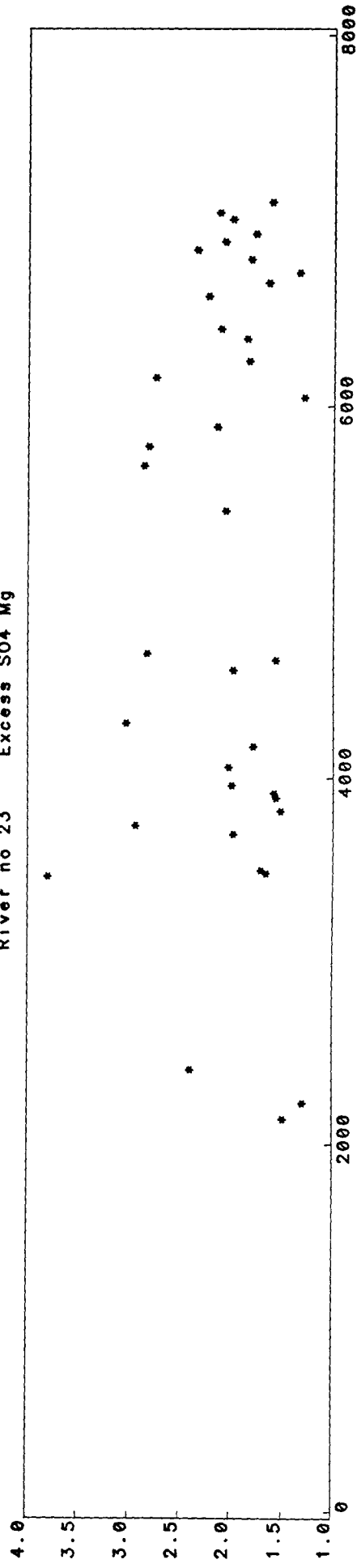

River no 25 Excess S04 Mg

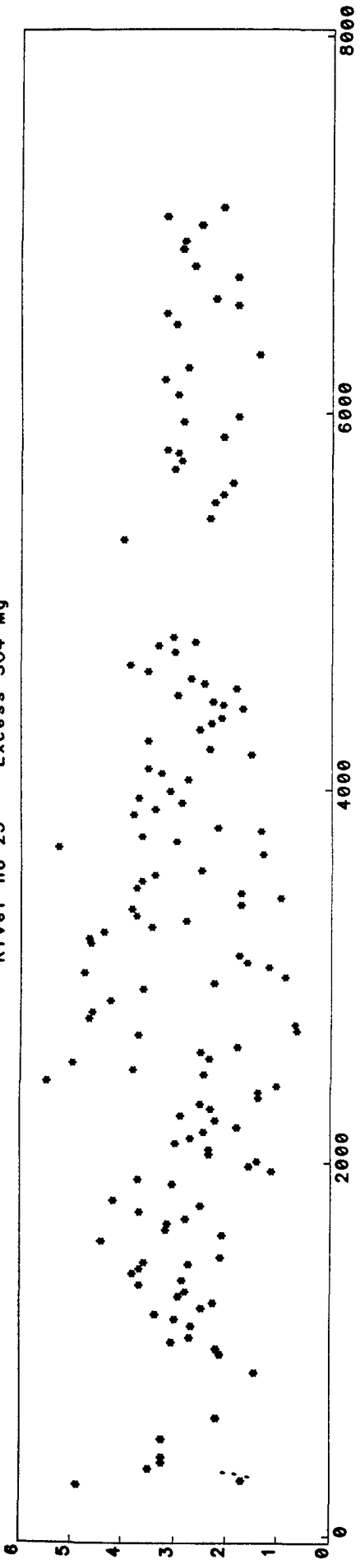

River no 26 Excess S04 Mg

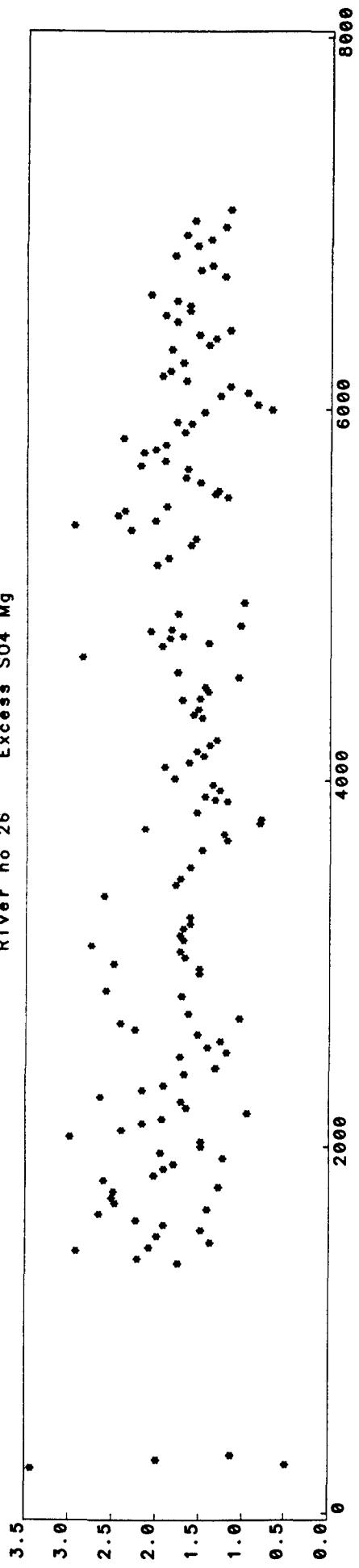

River no 27 Excess S04 Mg

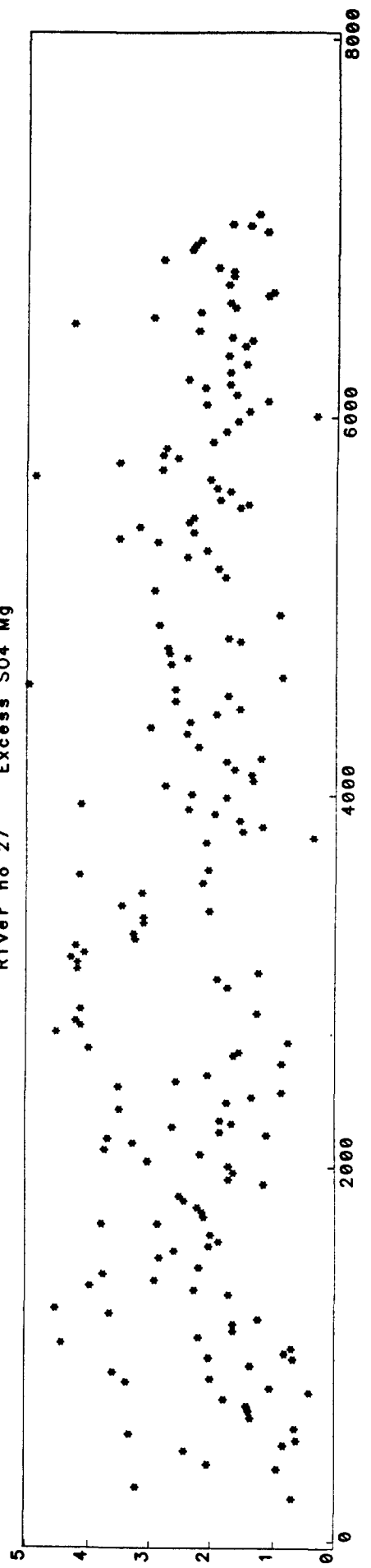

River no 28 Excess SO4 Mg

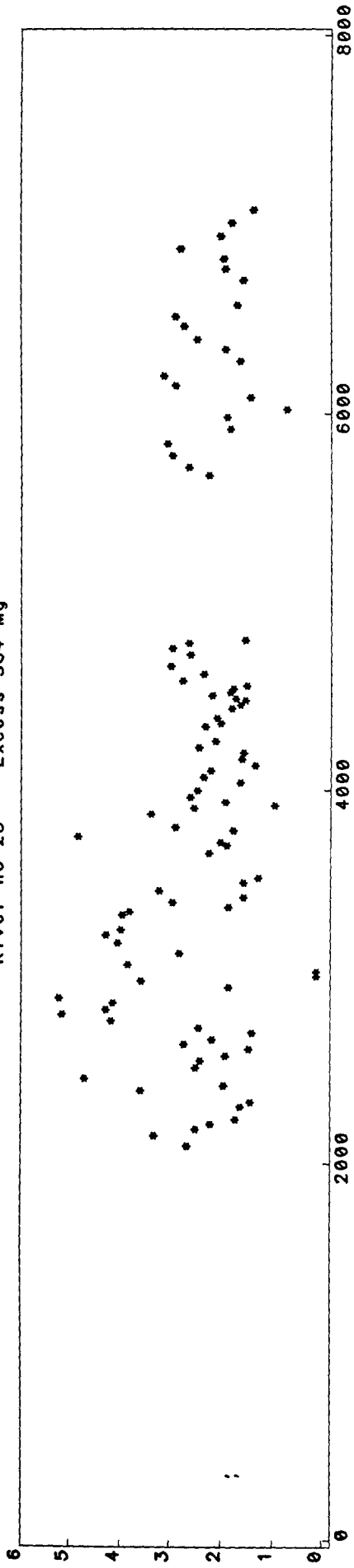

Appendix 2. Scatter plots of  $\text{NO}_3 + \text{NO}_2$  for the study rivers.

River no 1 NOx

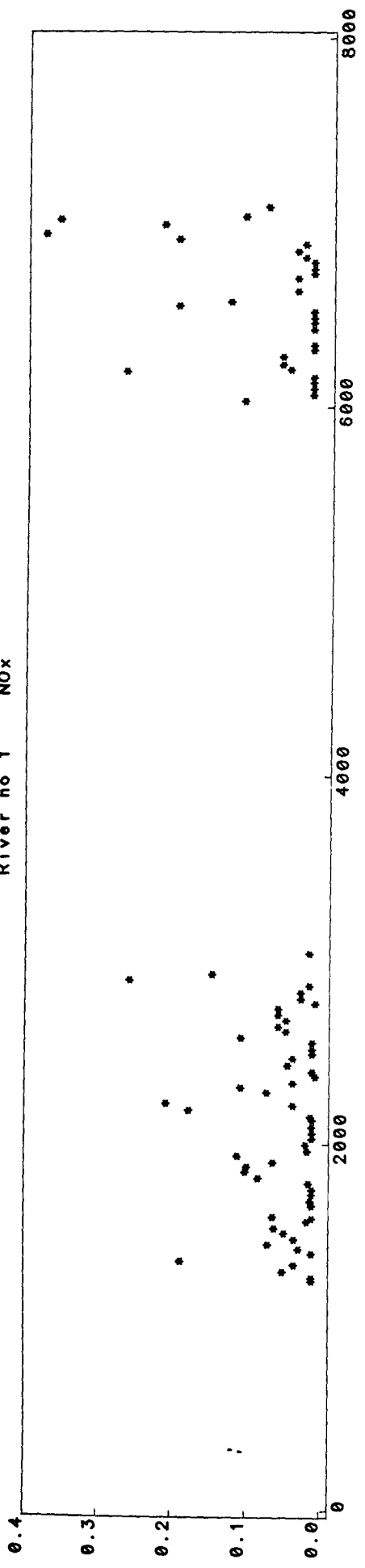

River no 2 NOx

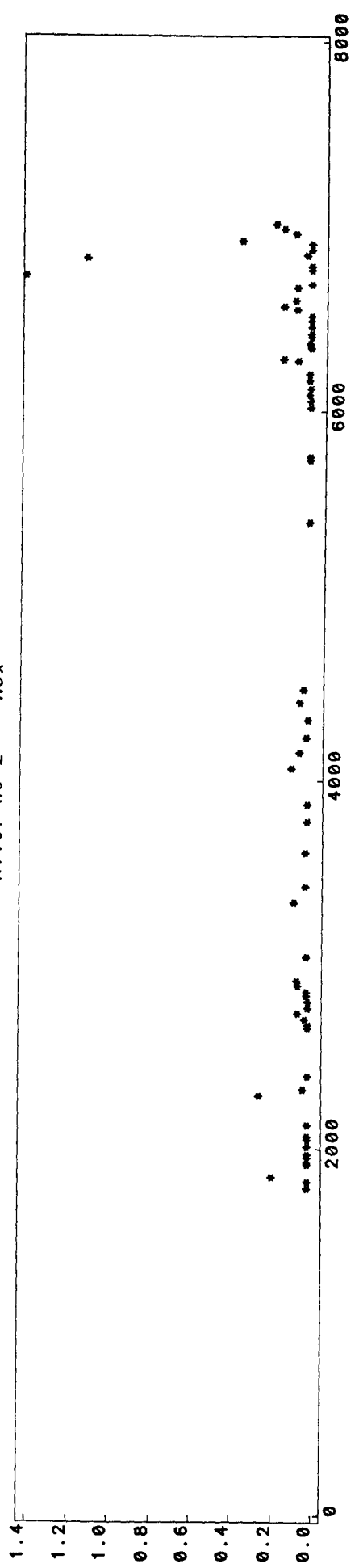

River no 3 NOx

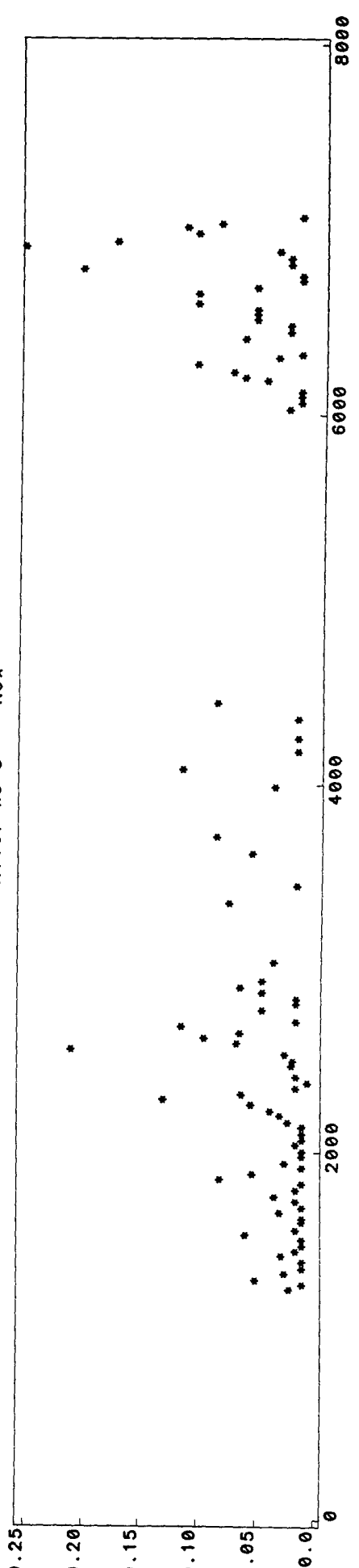

River no 4 NOx

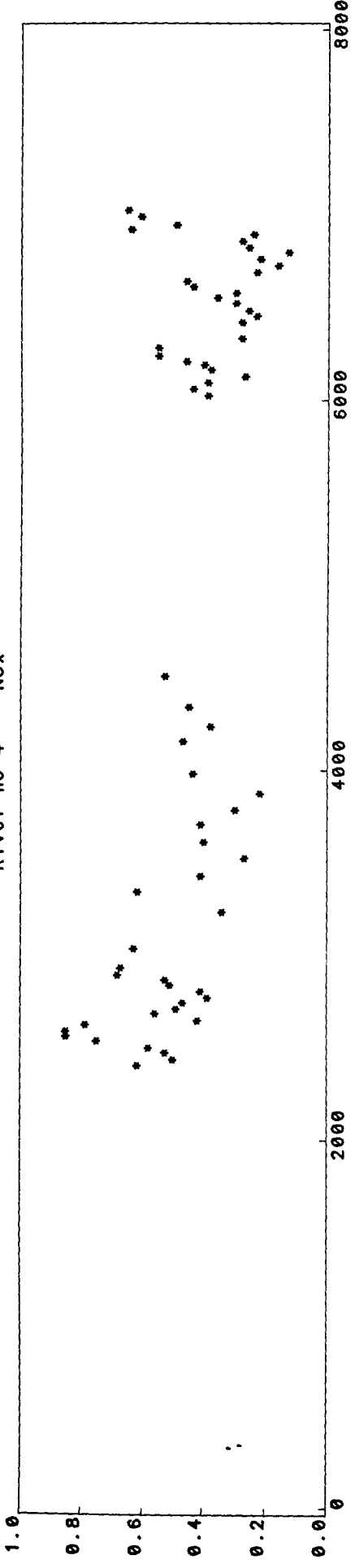

Julian Day  
River no 5 NOx

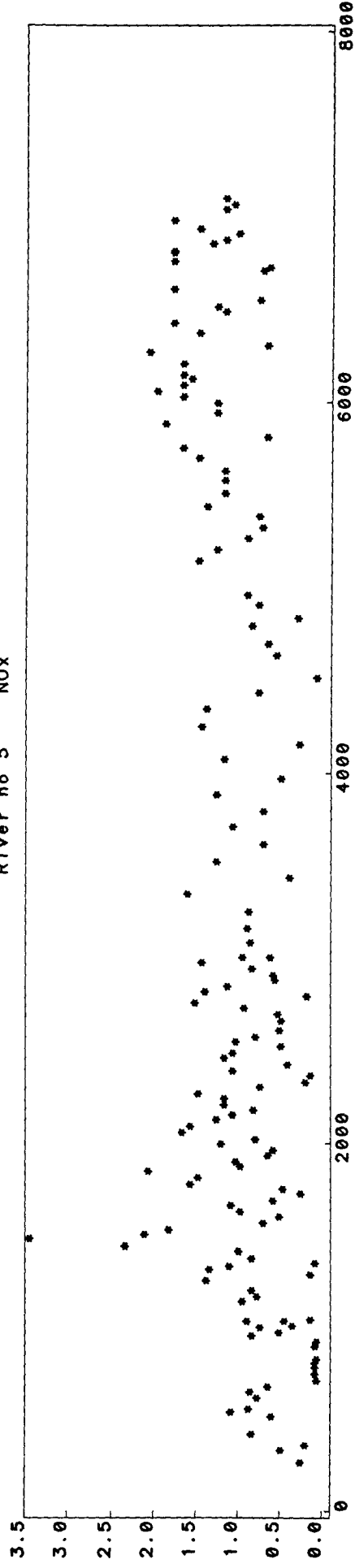

Julian Day  
River no 6 NOx

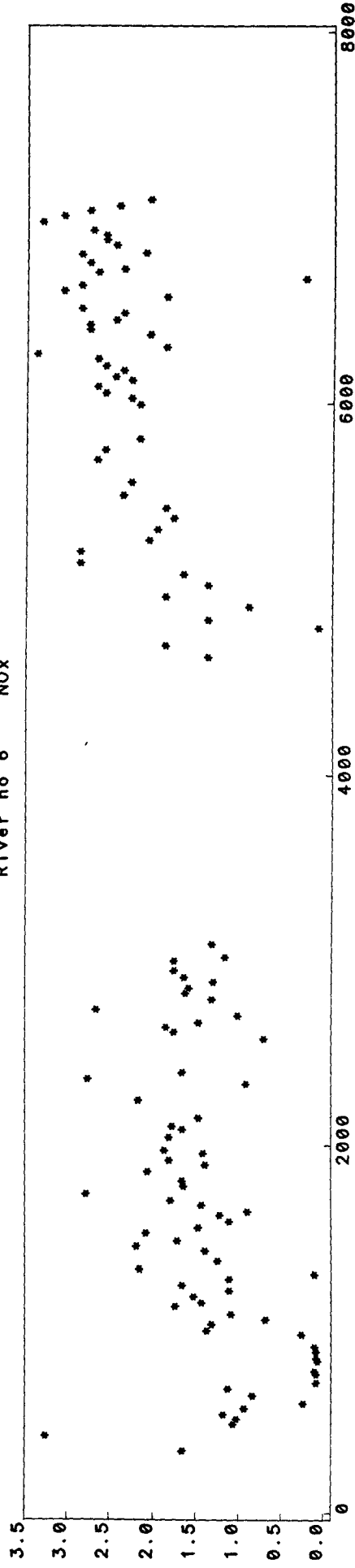

River no 7 NOx

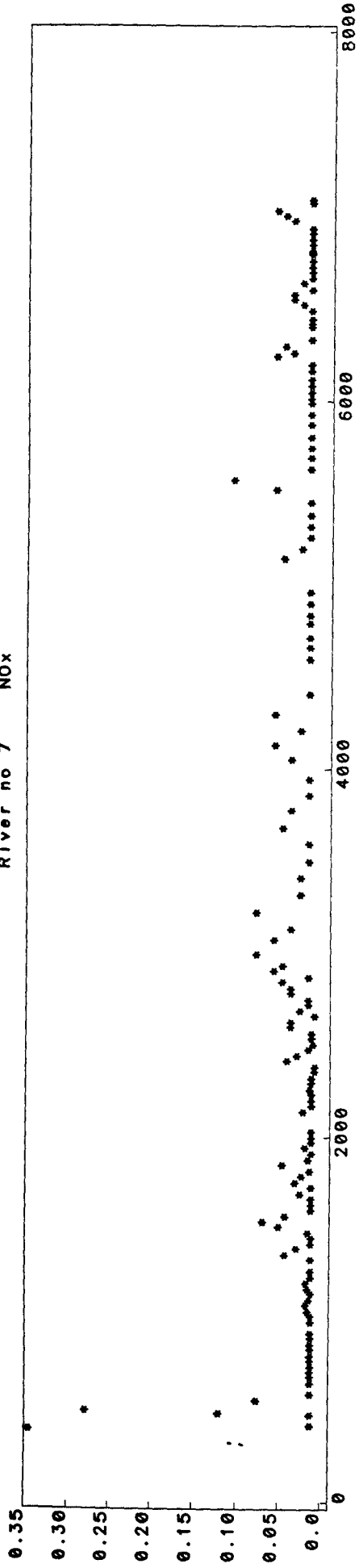

Julian Day  
River no 8 NOx

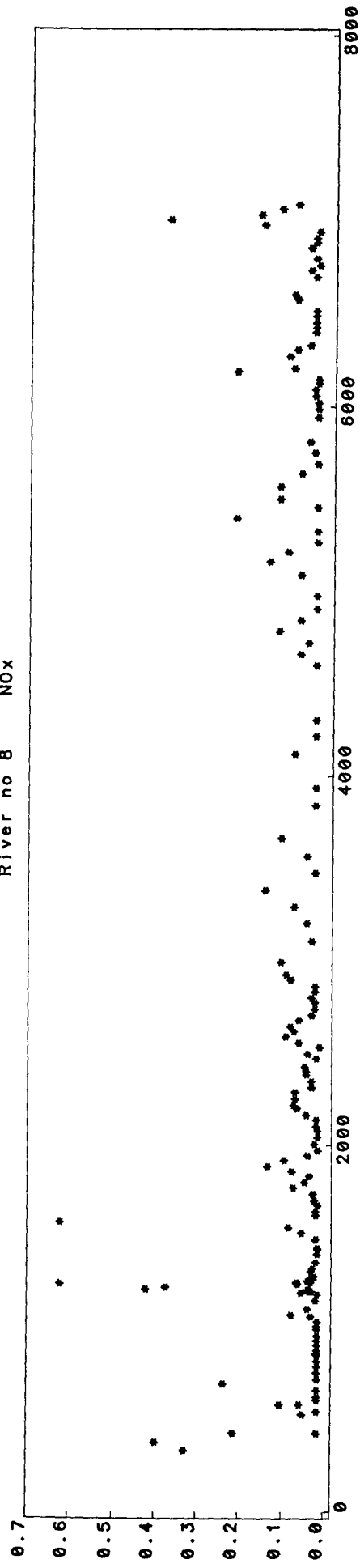

Julian Day  
River no 9 NOx

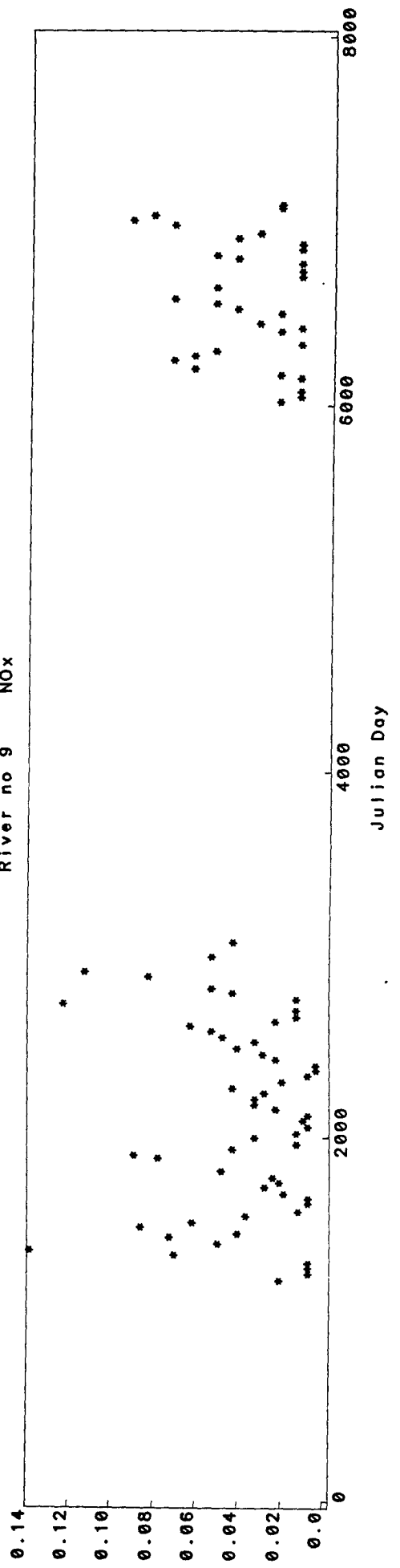

River no 10 NOx

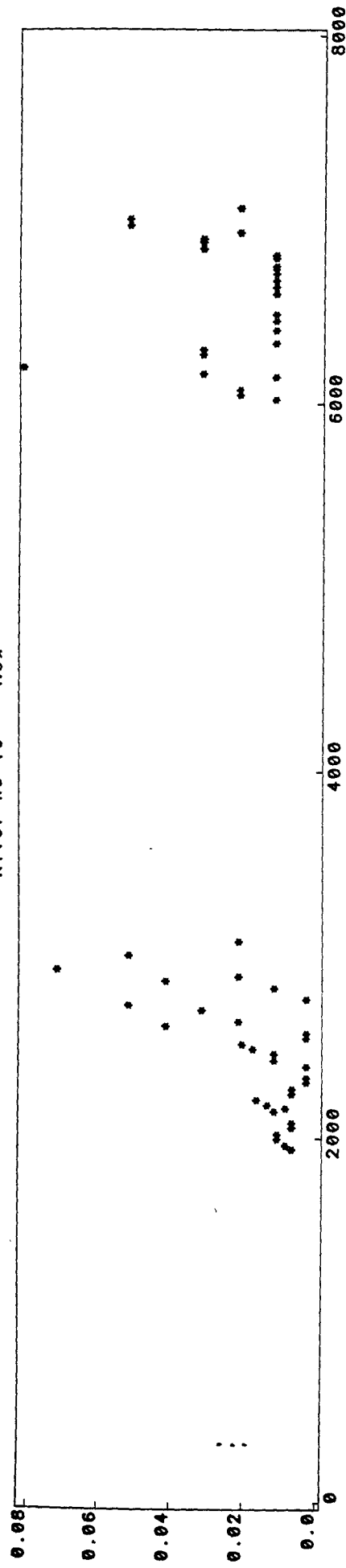

Julian Day  
River no 11 NOx

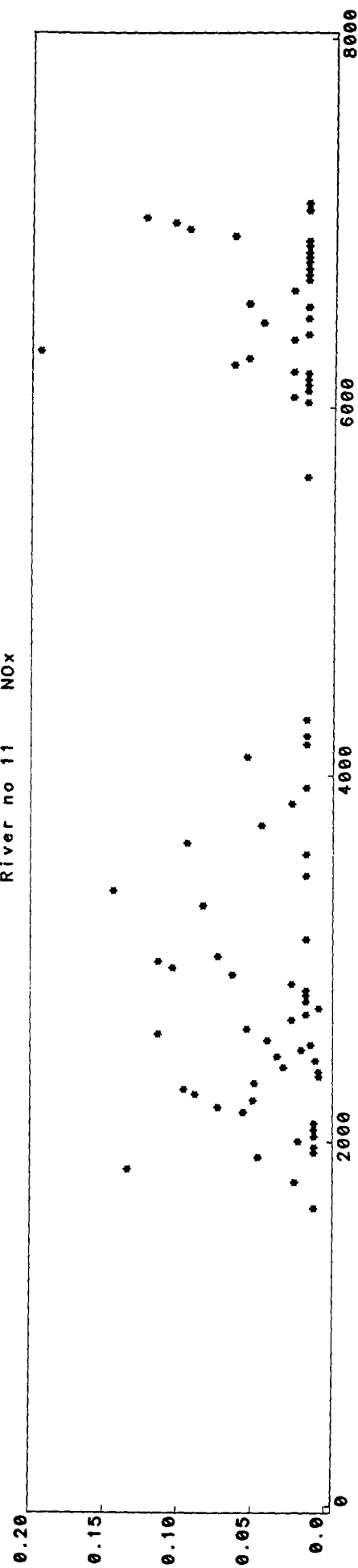

Julian Day  
River no 12 NOx

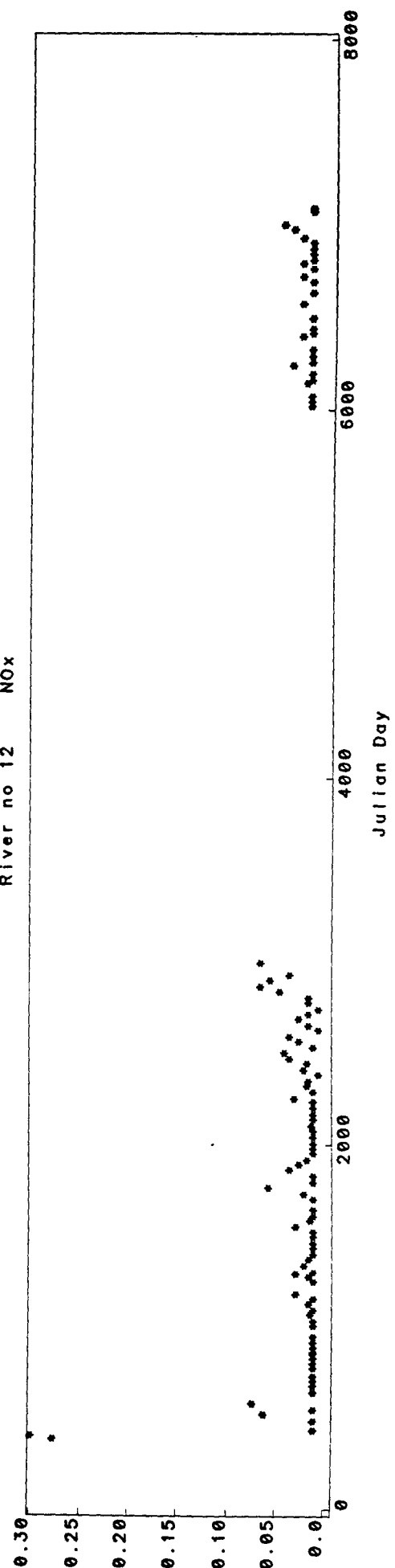



River no 13 NOx

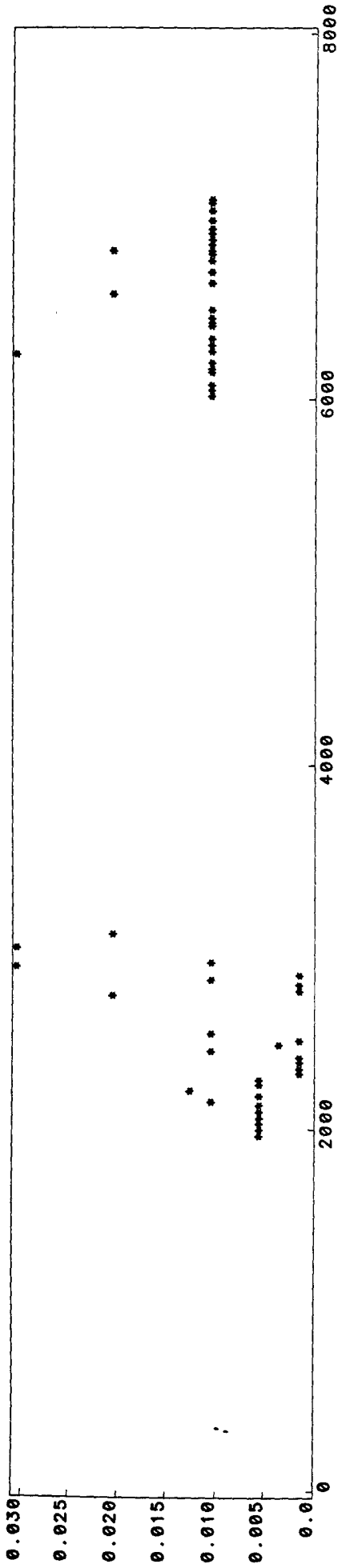

Julian Day  
River no 16 NOx

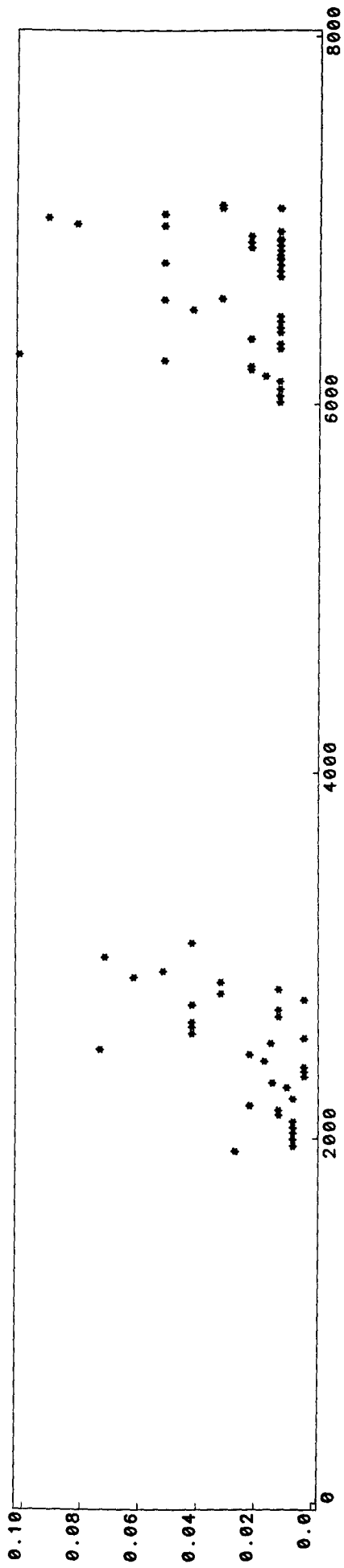

Julian Day  
River no 17 NOx

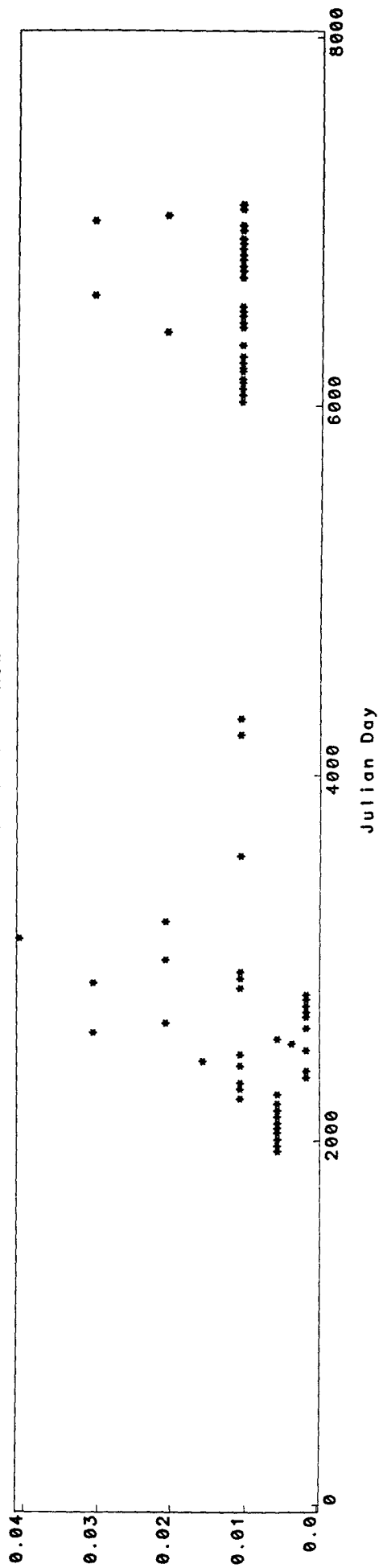

River no 18 NOx

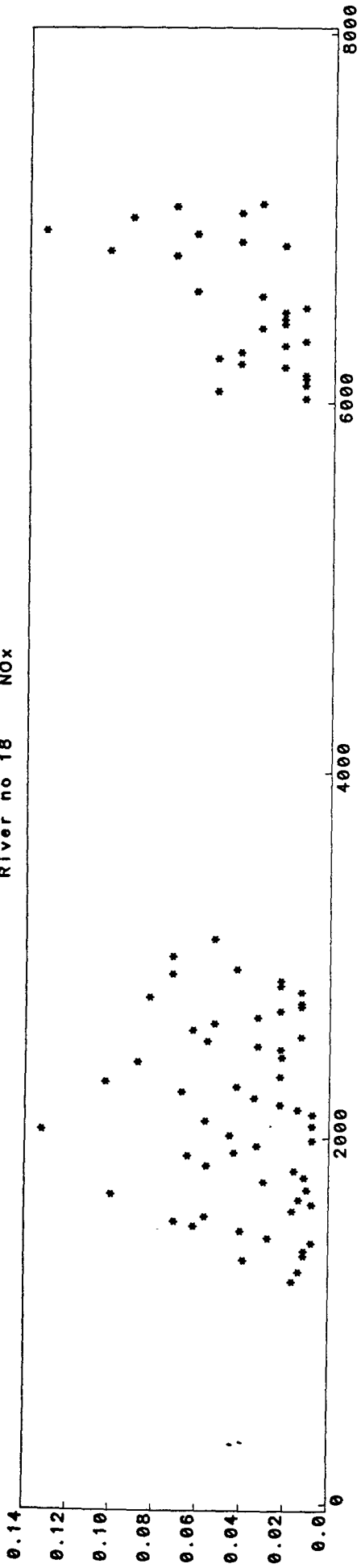

Julian Day  
River no 19 NOx

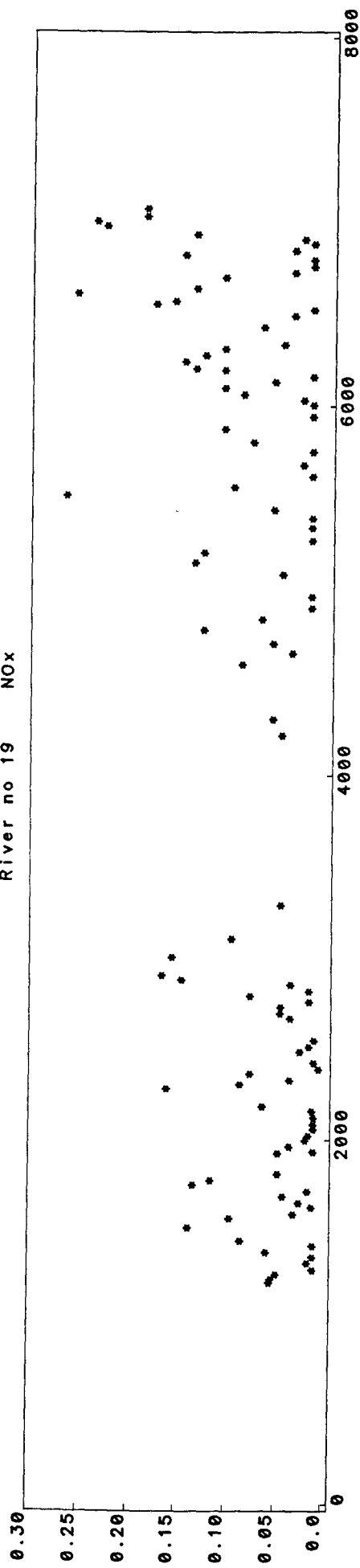

Julian Day  
River no 20 NOx

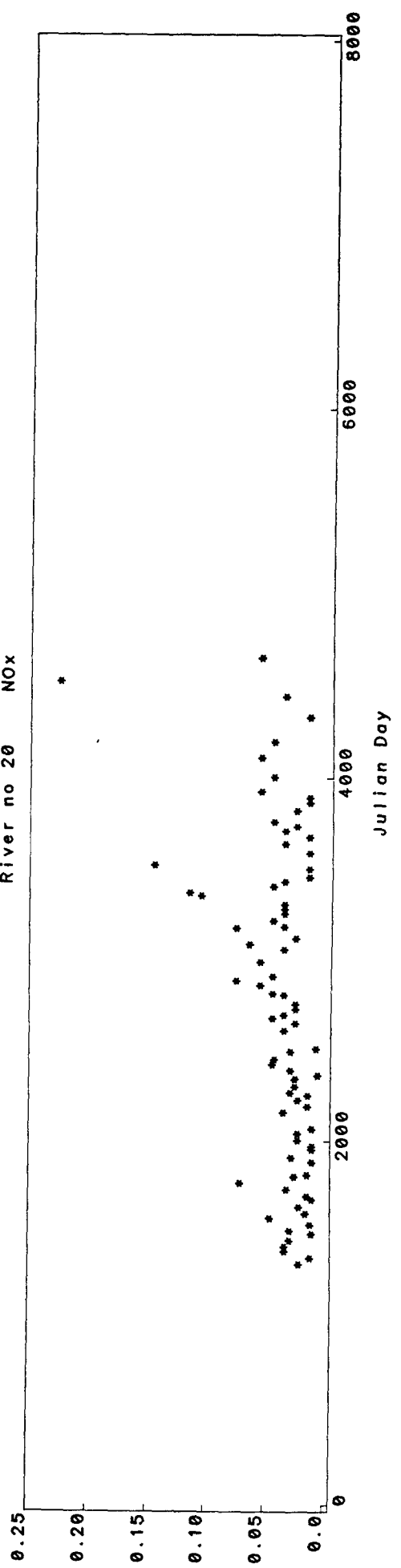

River no 21 NOx

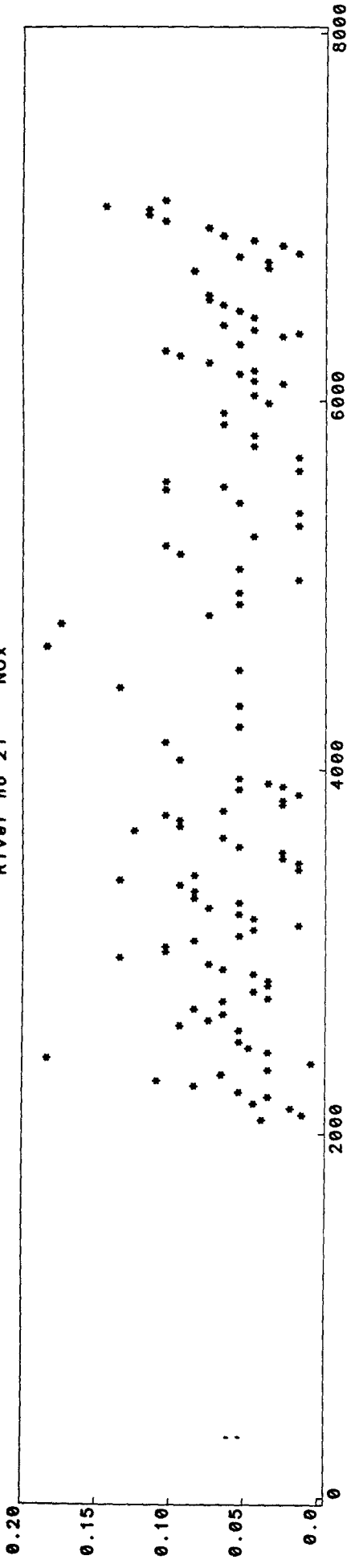

Julian Day

River no 22 NOx

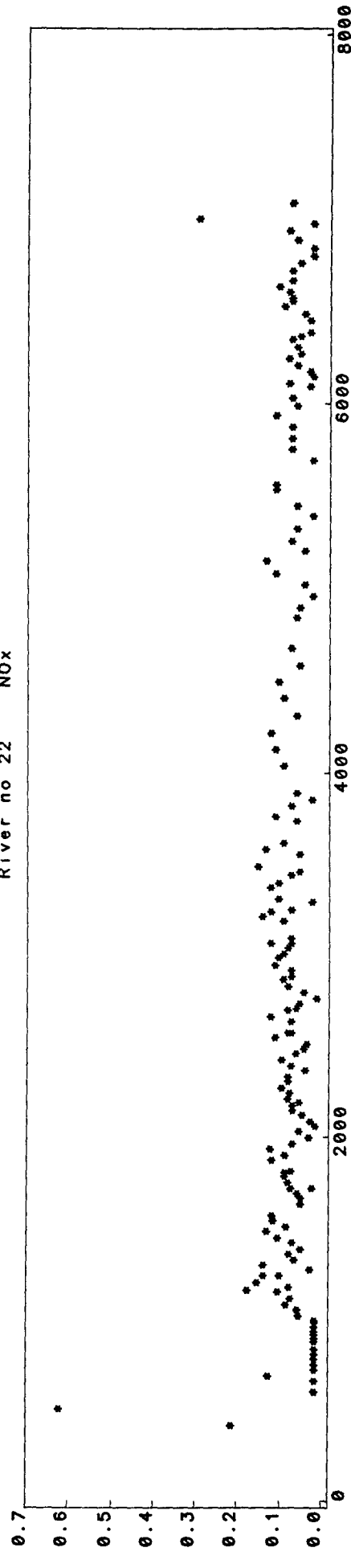

Julian Day

River no 23 NOx

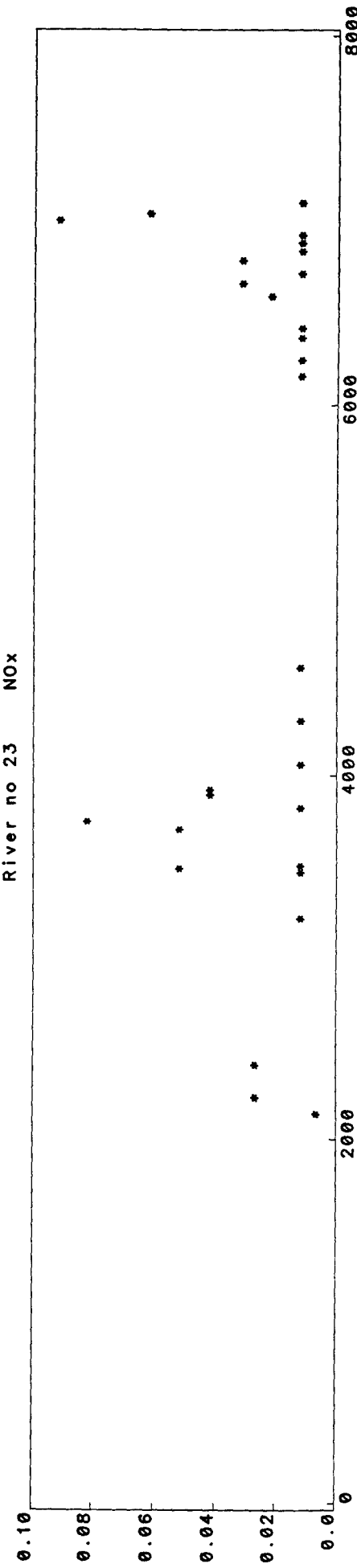

Julian Day

River no 25 NOx

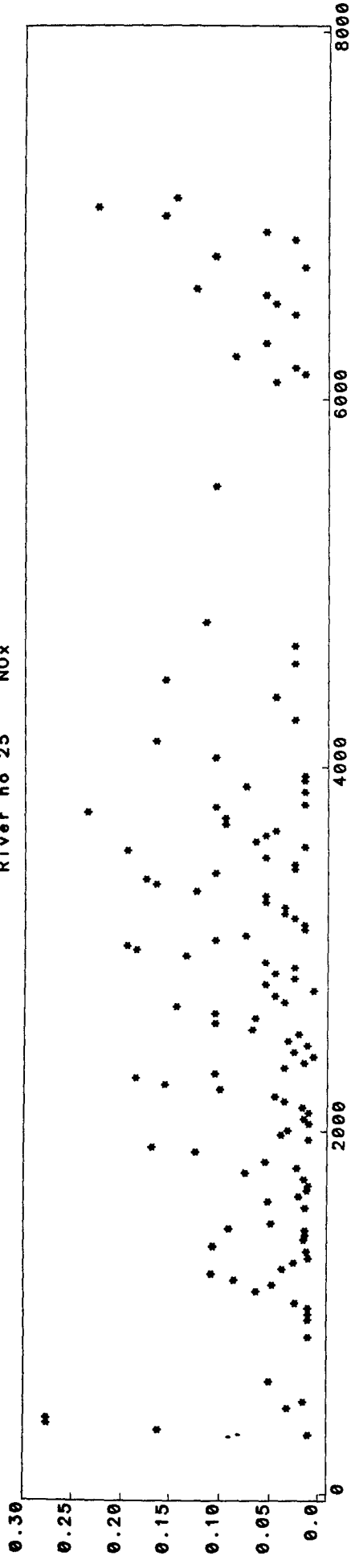

Julian Day  
River no 26 NOx

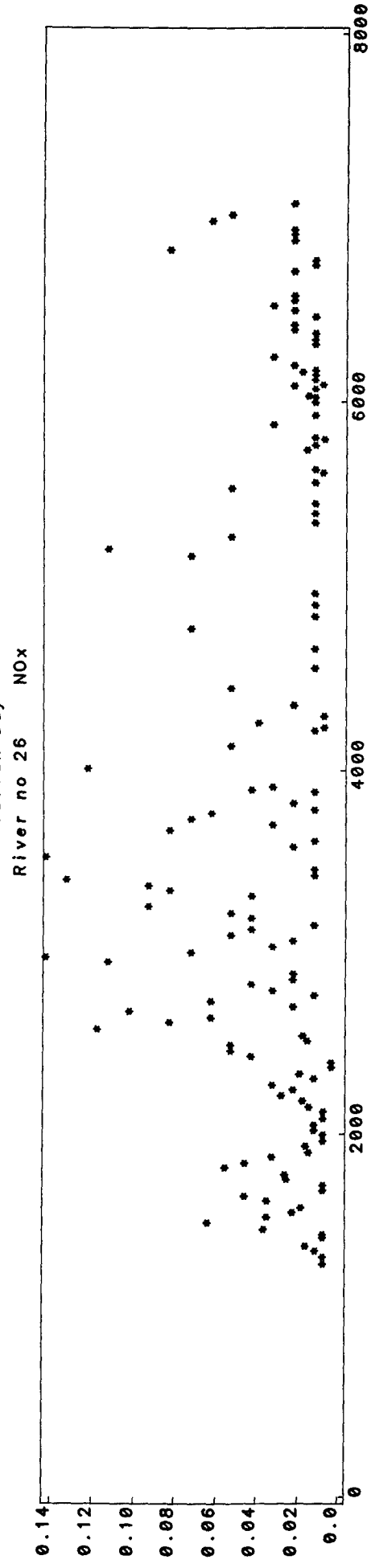

Julian Day  
River no 27 NOx

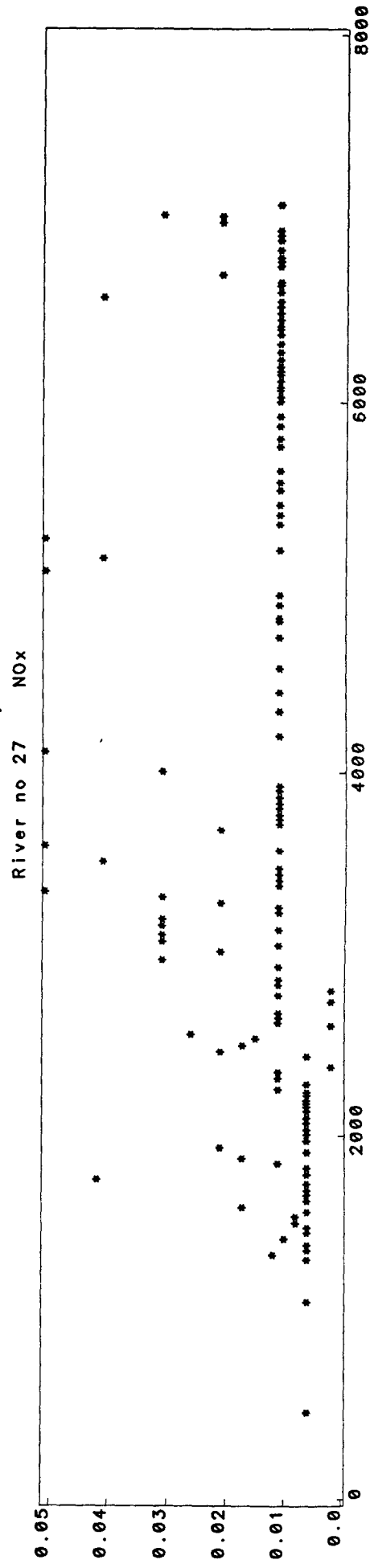

River no 28 NOx

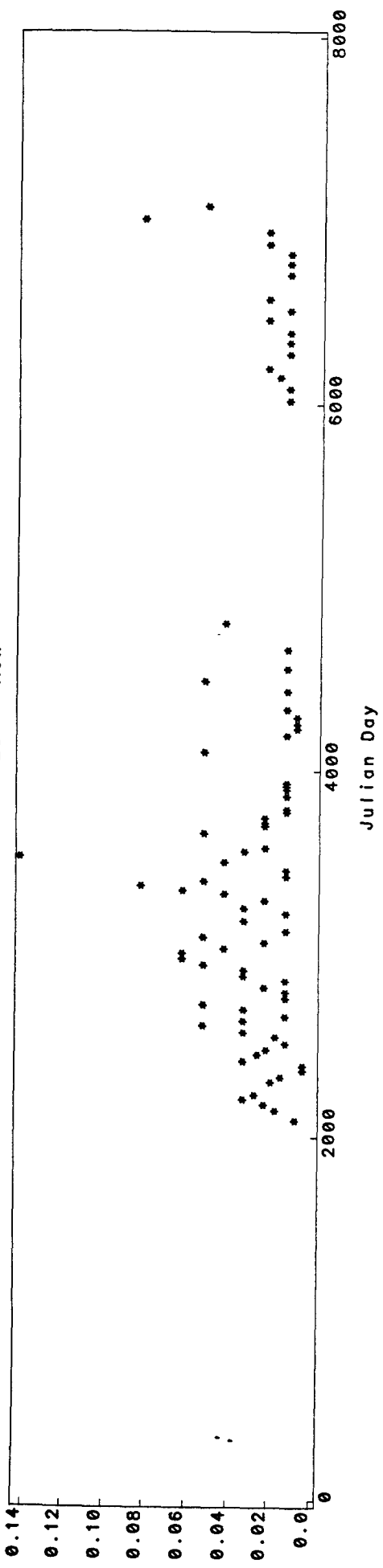

Appendix 3. Scatter plots of calcium for the study rivers.

River no 1 Calcium

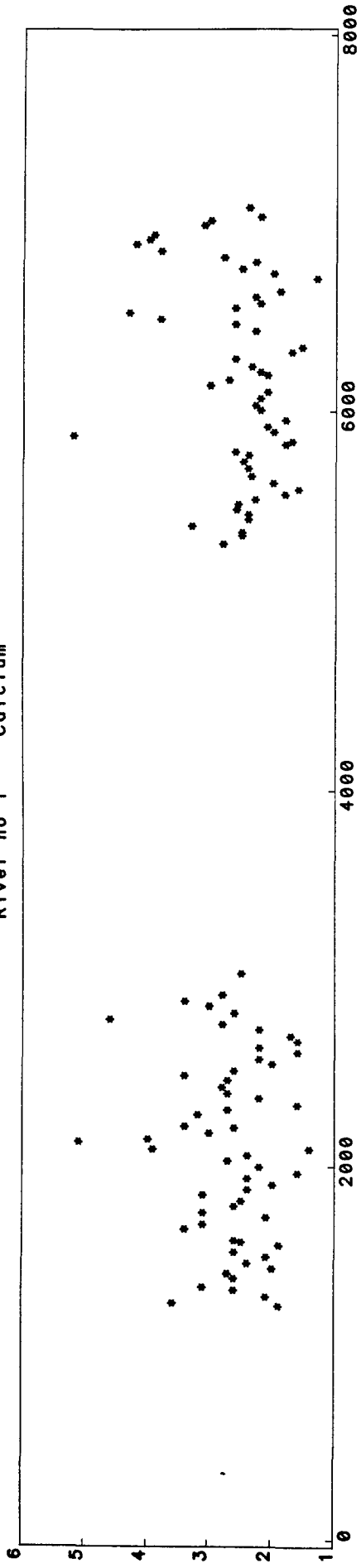

River no 2 Calcium

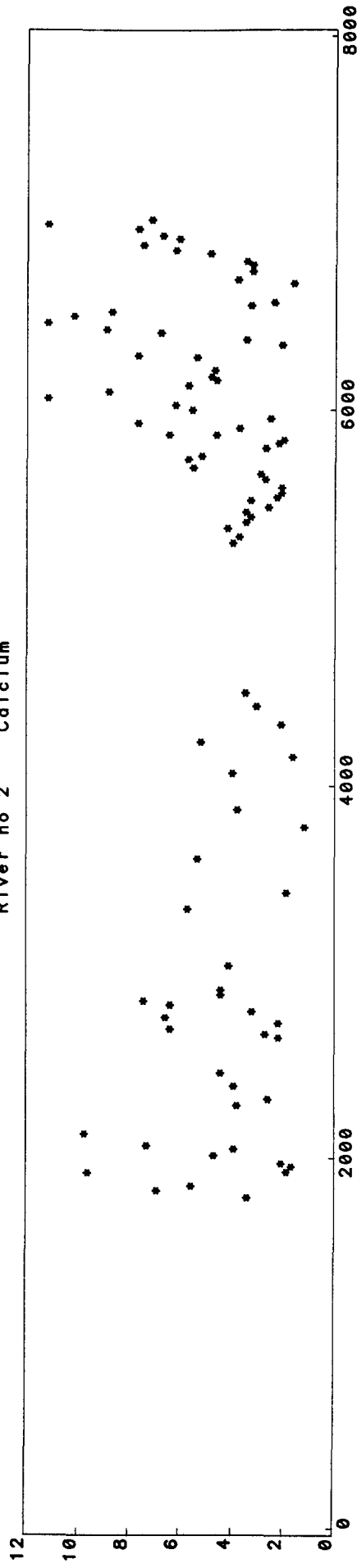

River no 3 Calcium

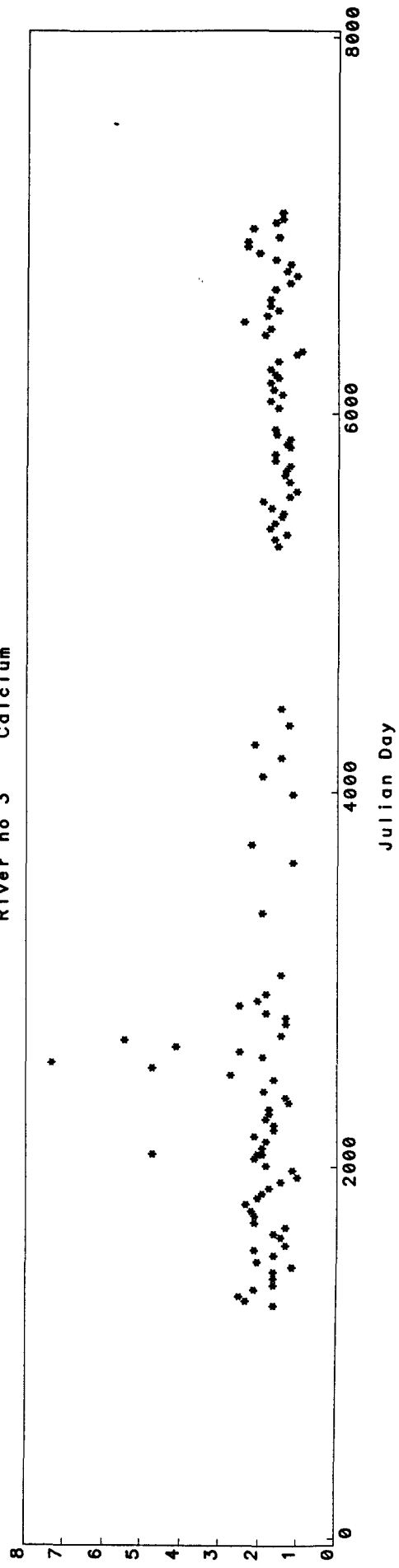

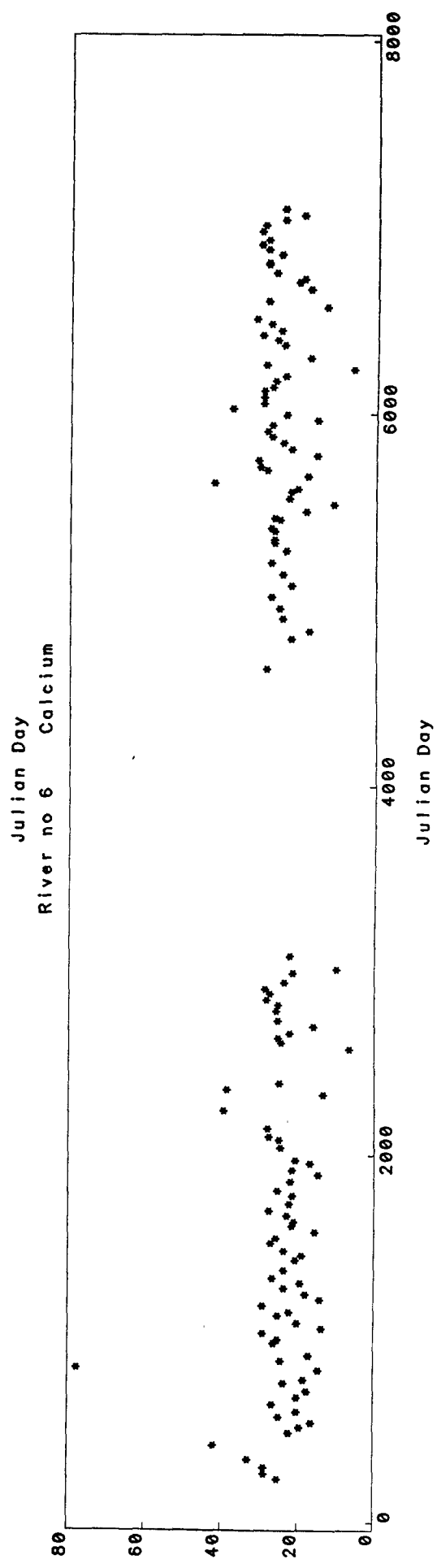
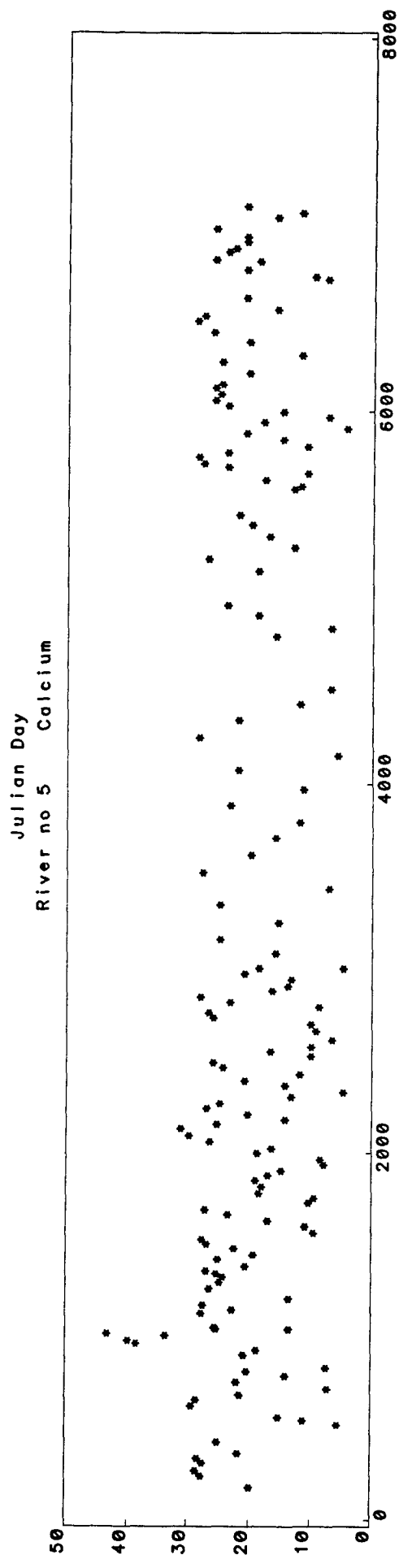
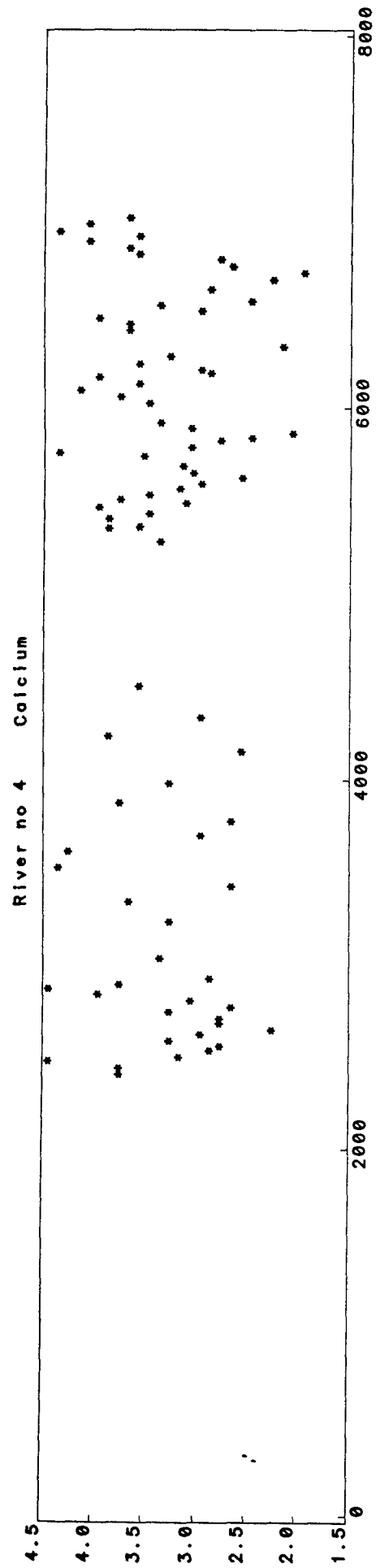



River no 7 Calcium

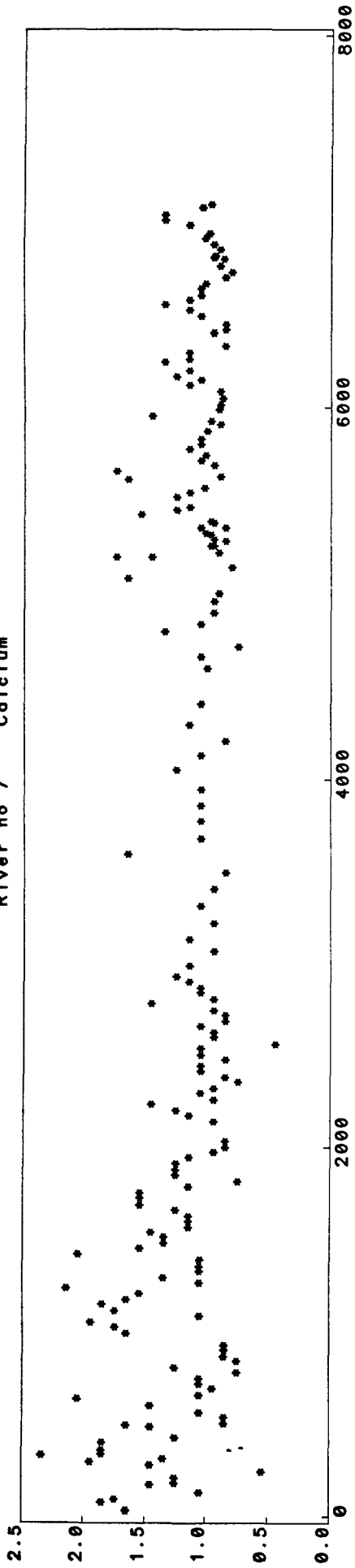

River no 8 Calcium

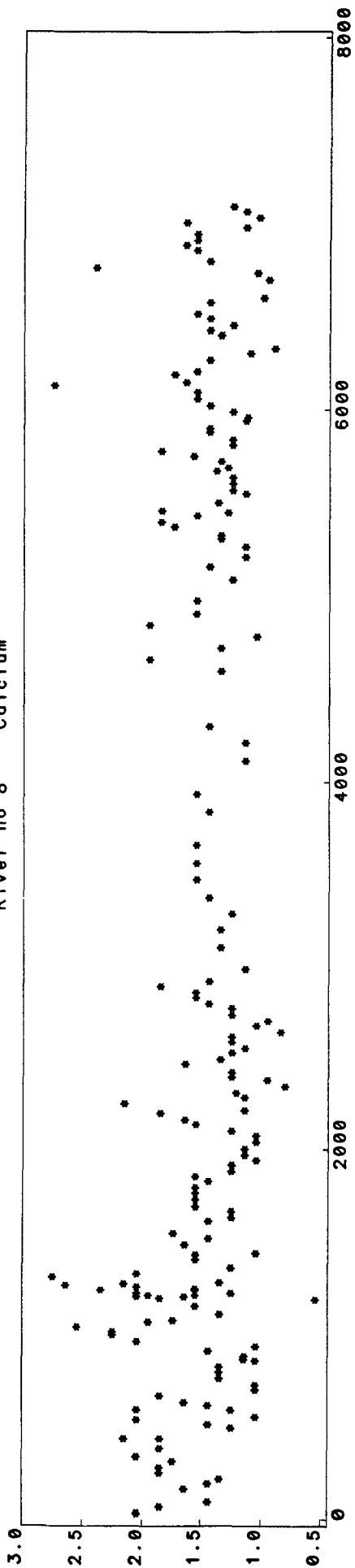

River no 9 Calcium

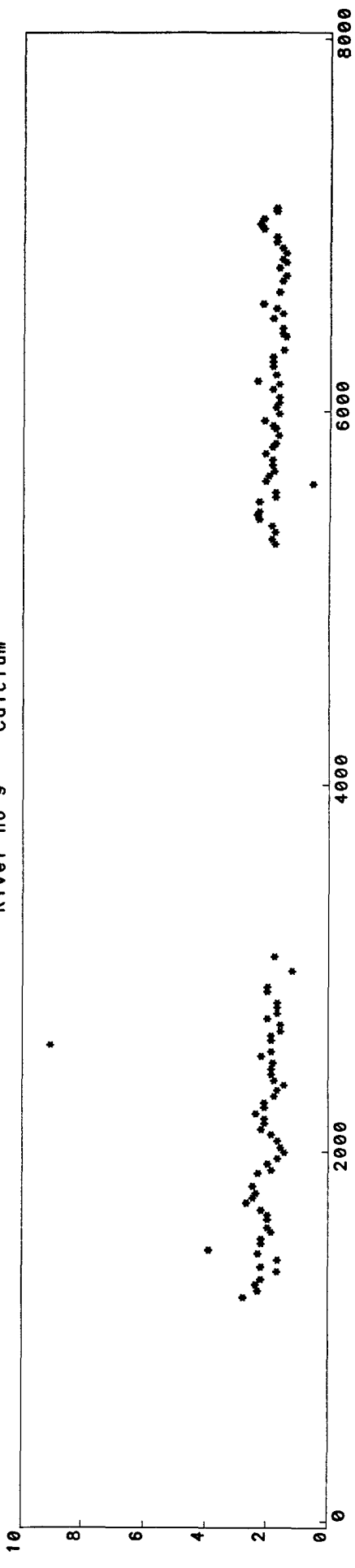

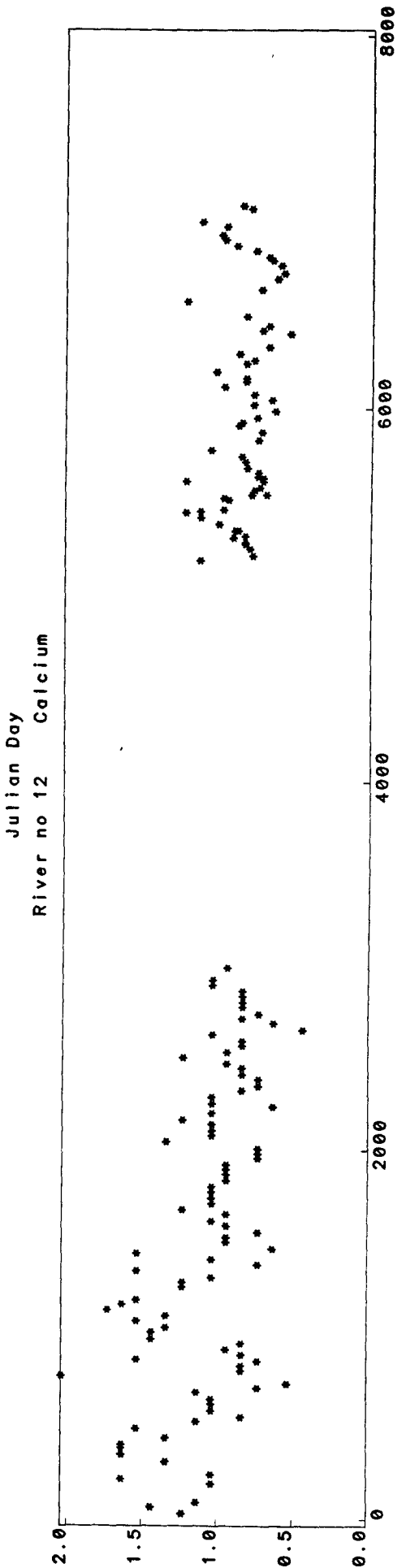
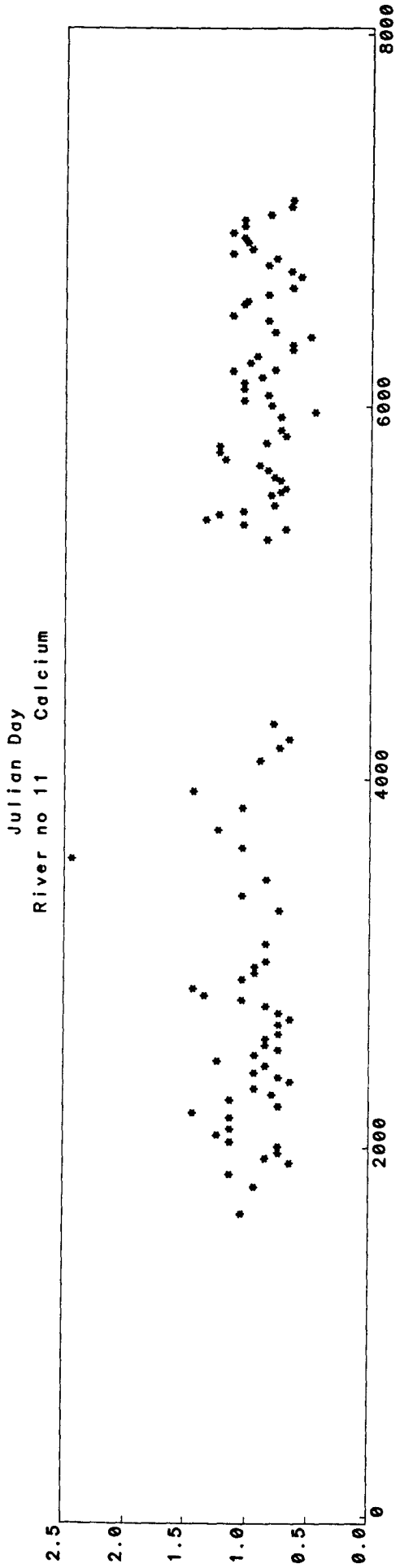
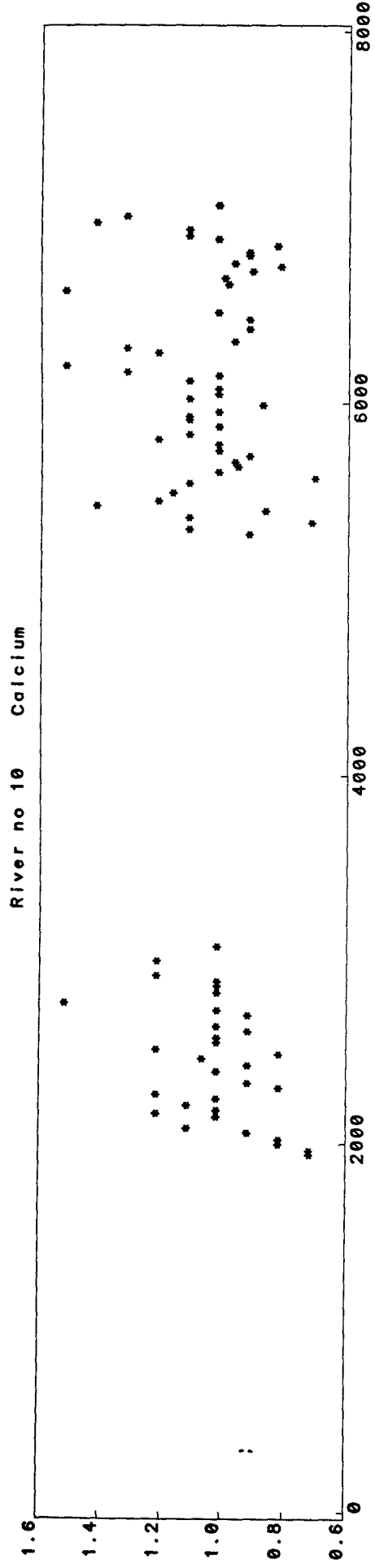

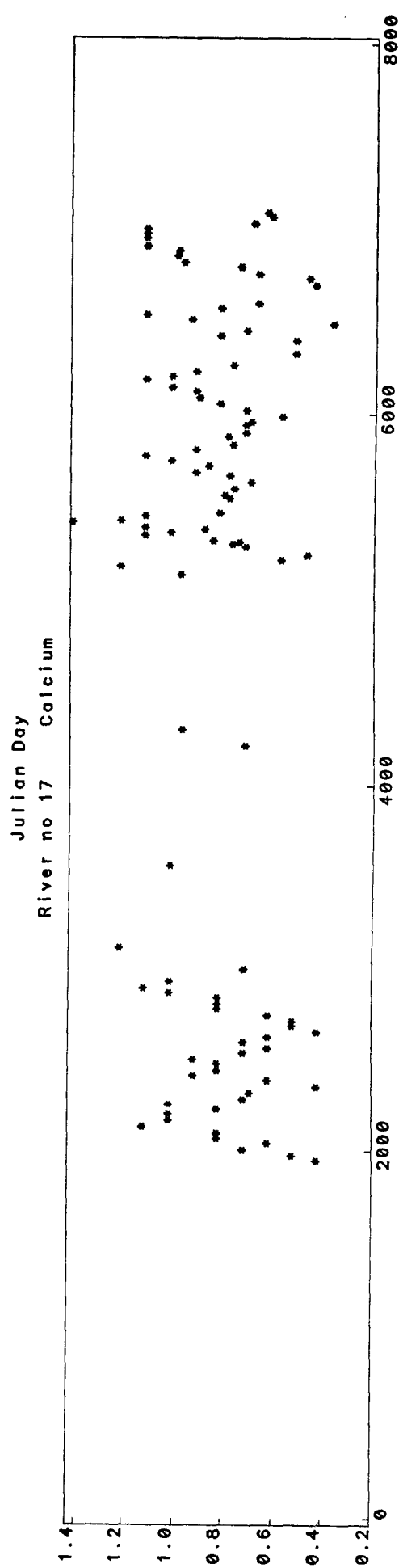
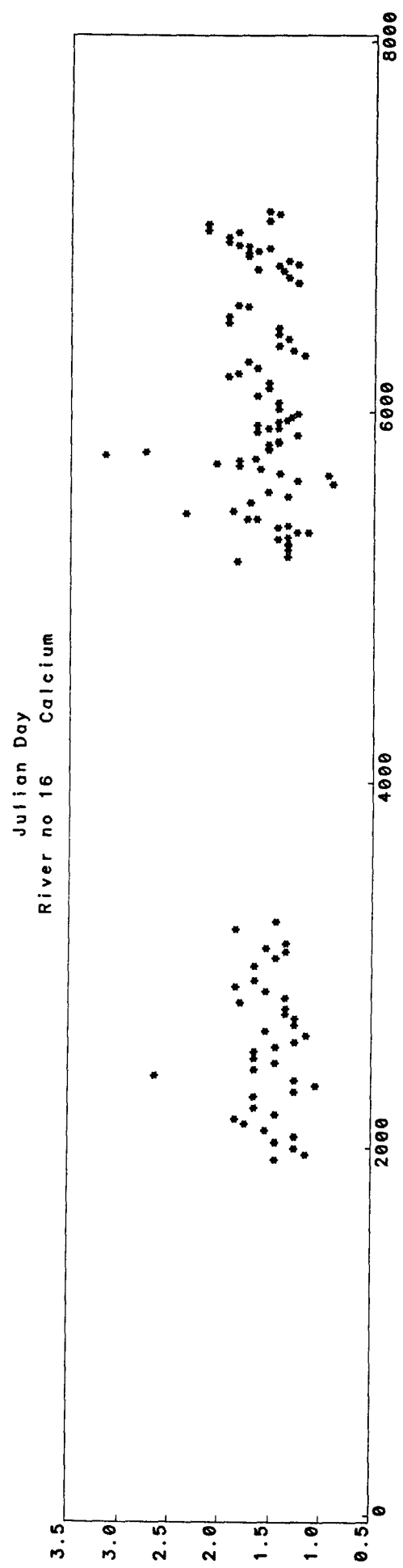
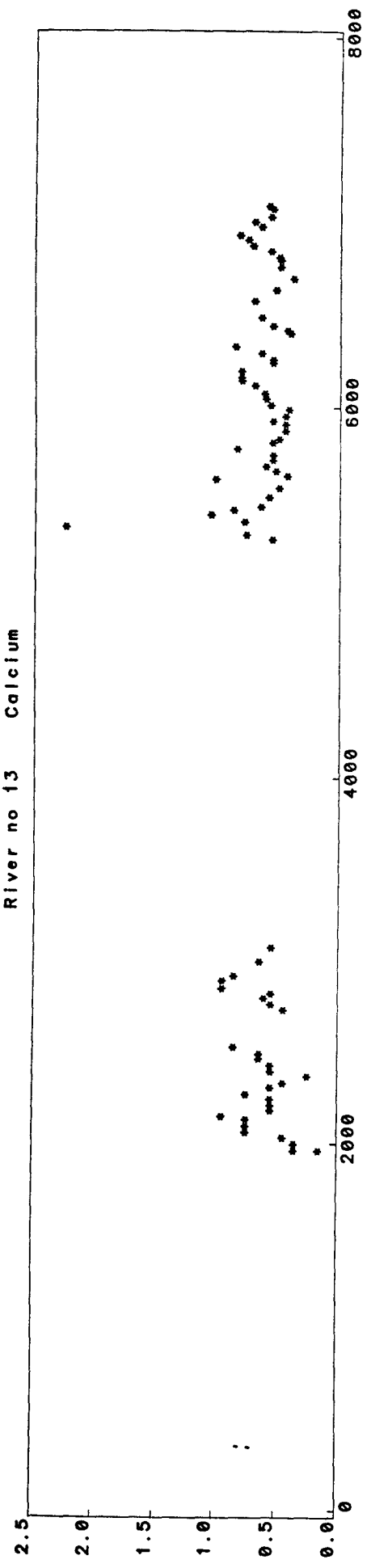

River no 18 Calcium

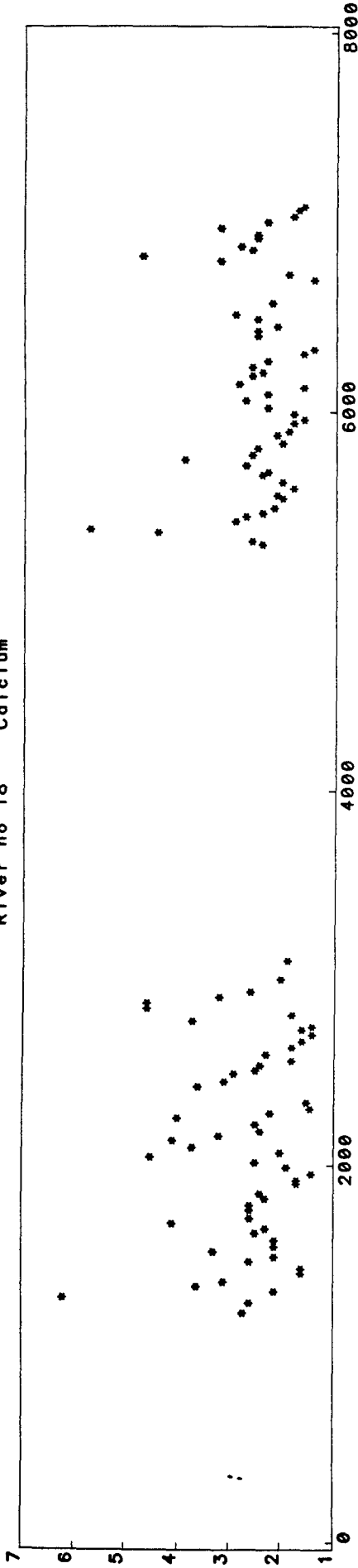

Julian Day  
River no 19 Calcium

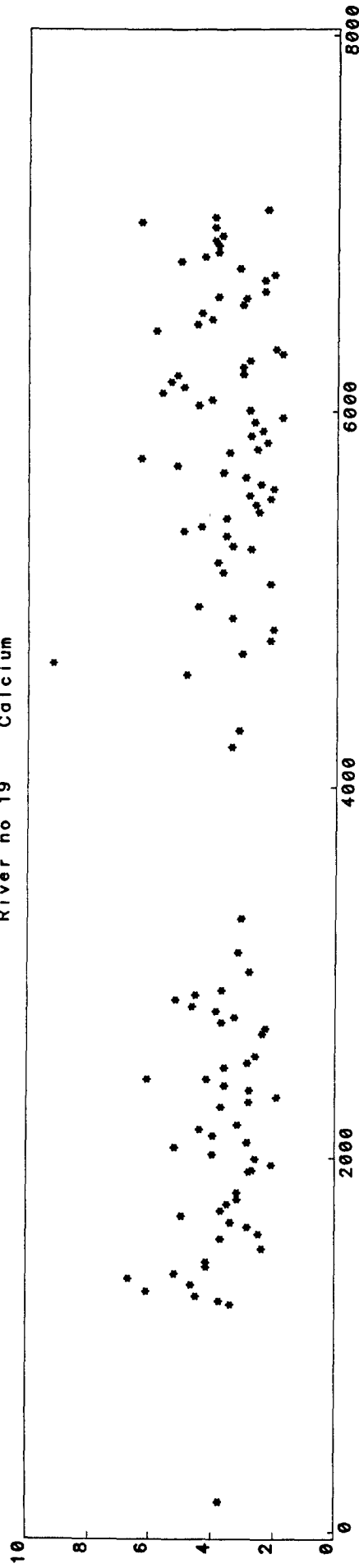

Julian Day  
River no 20 Calcium

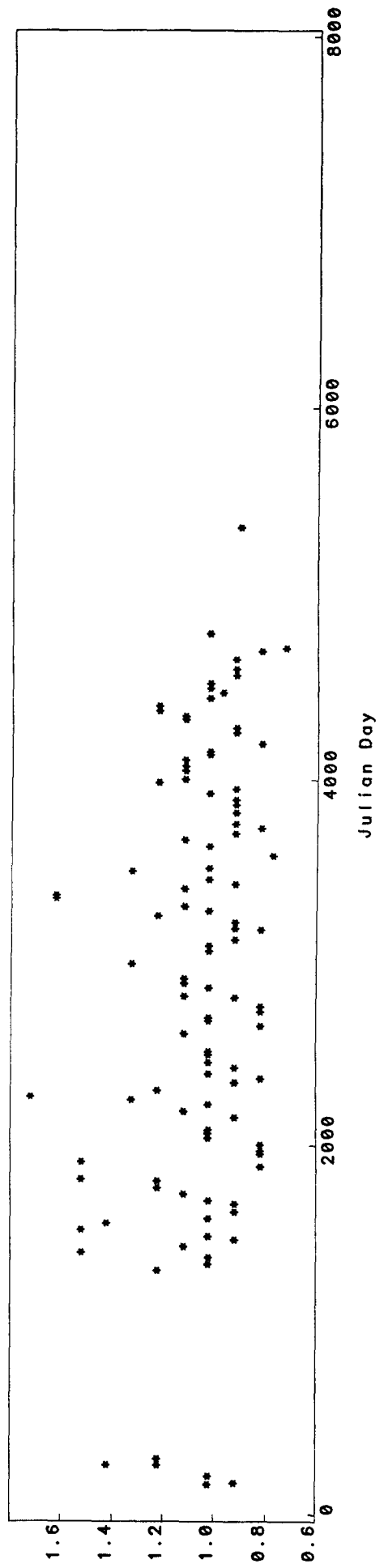

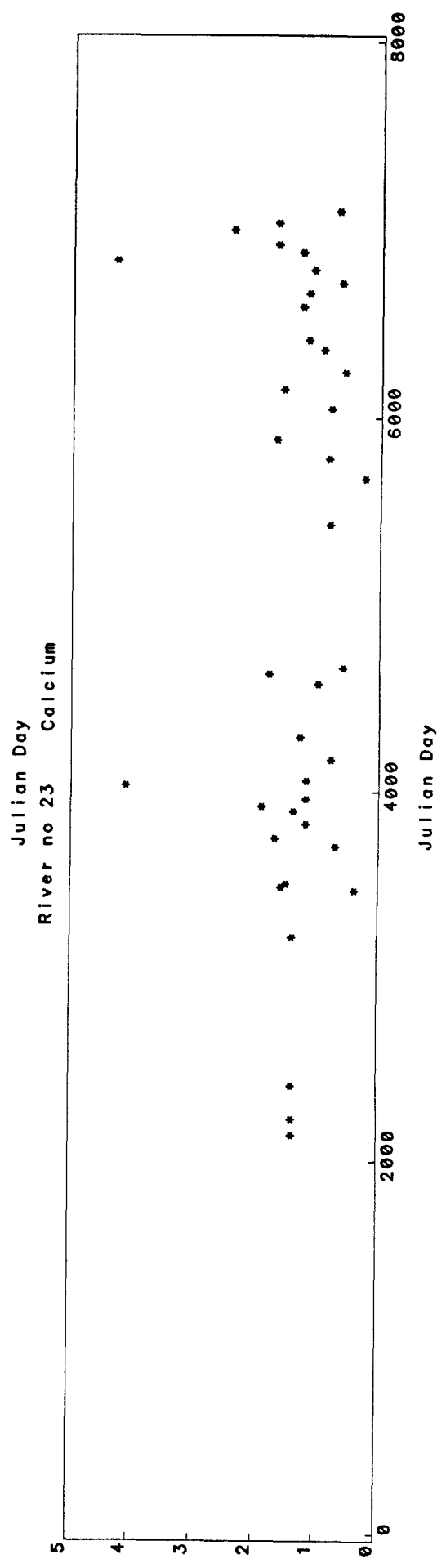
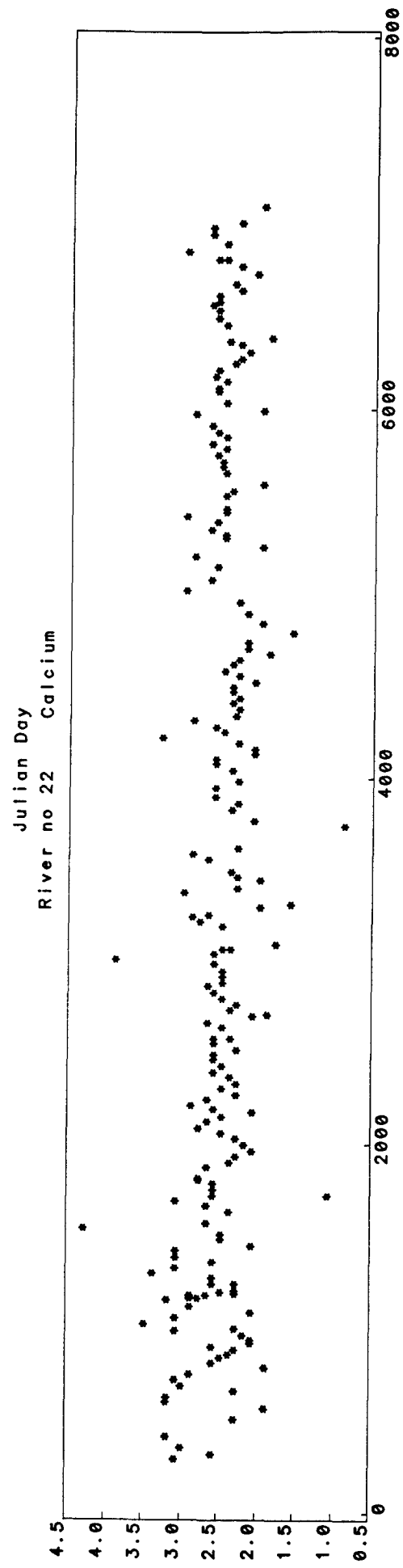
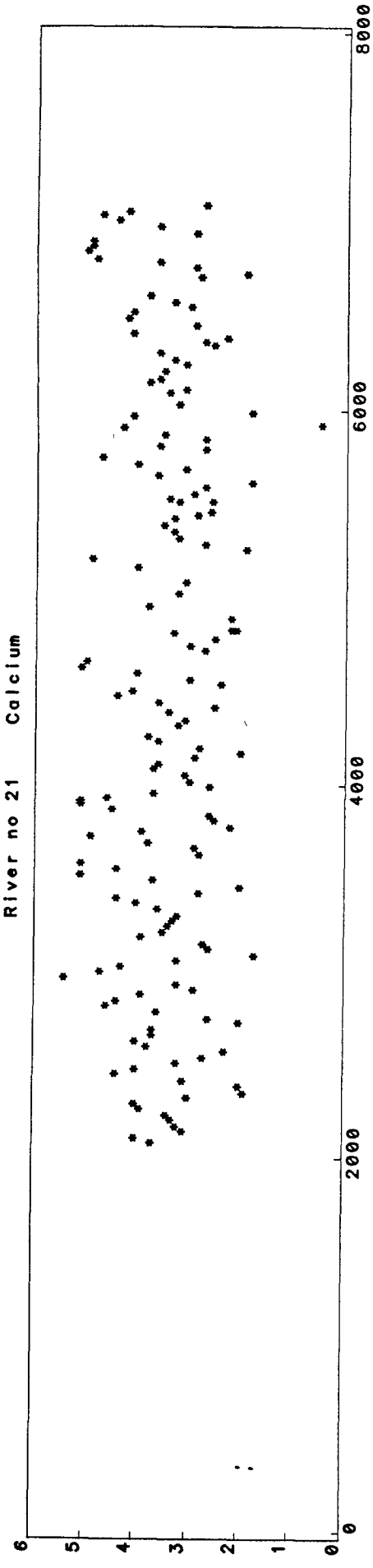

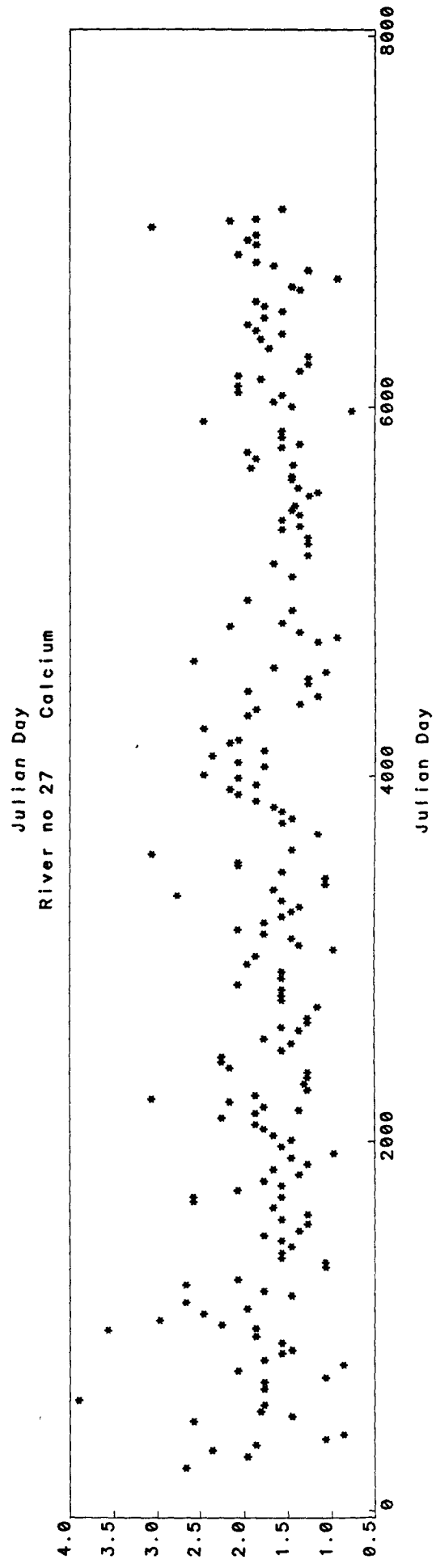
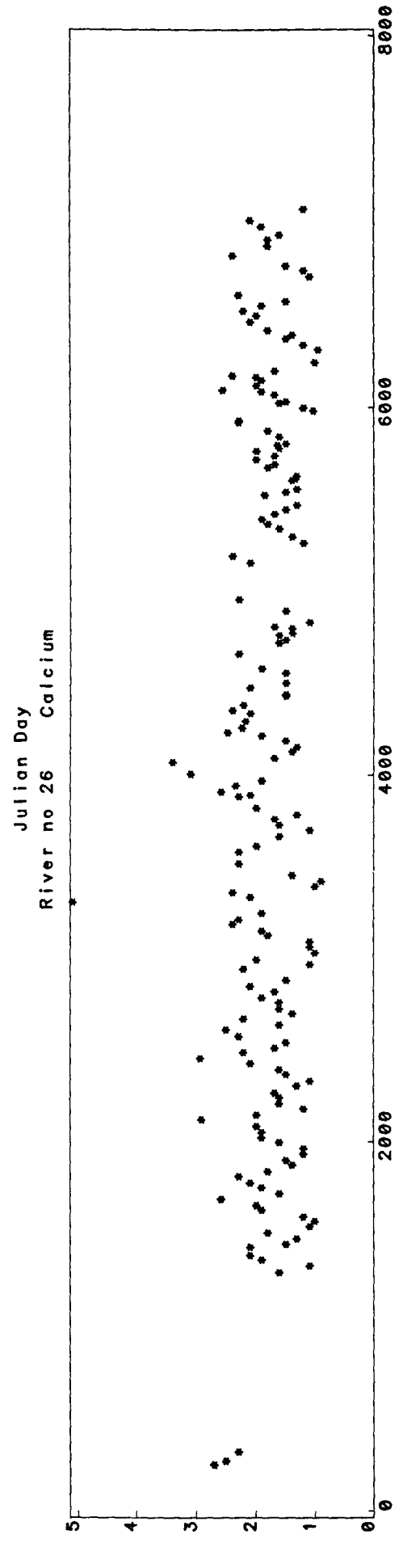
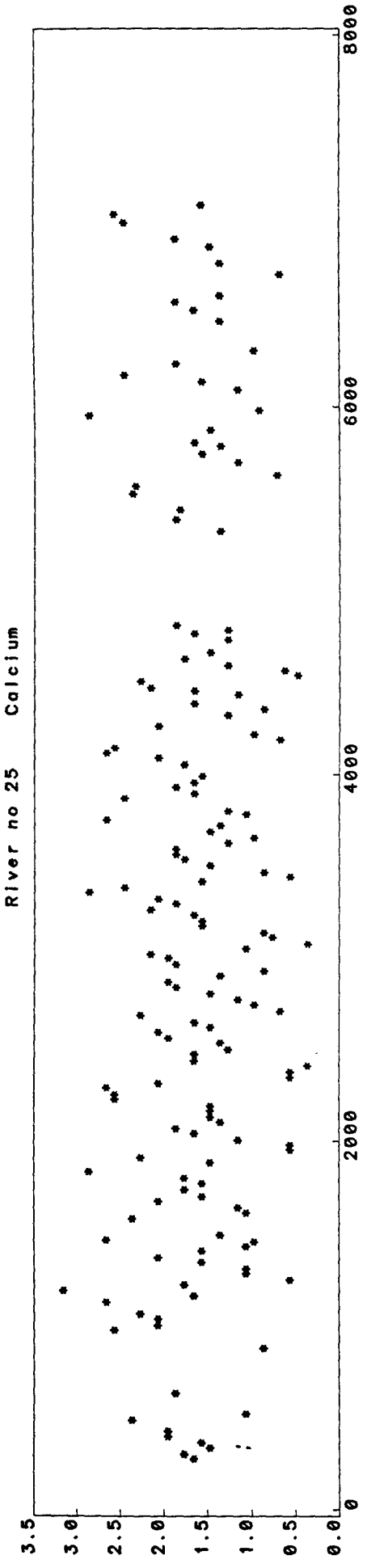

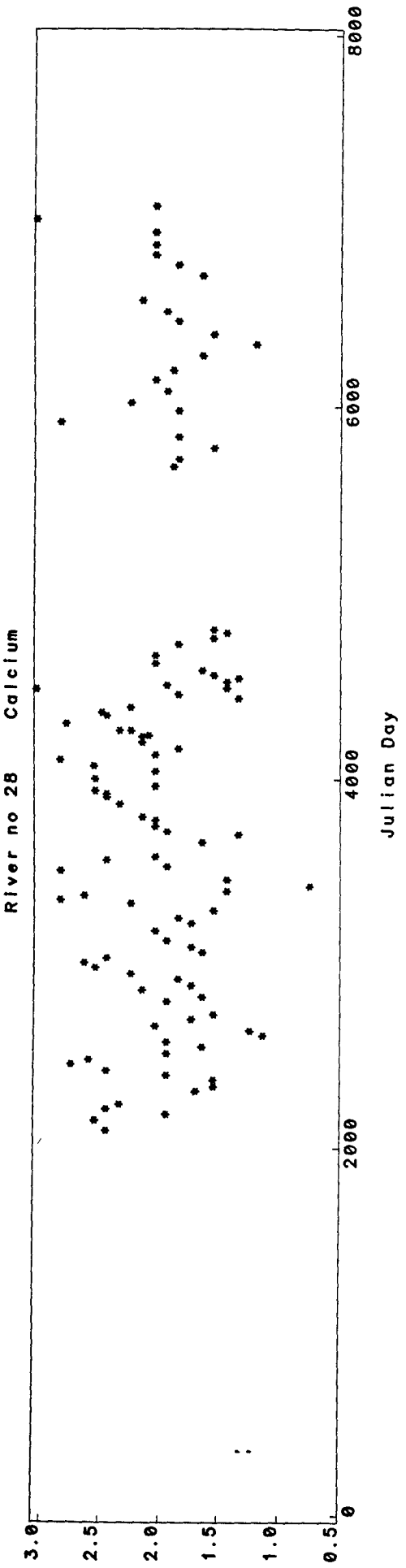

Appendix 4. Scatter plots of iron for the study rivers.



River no 1 Iron

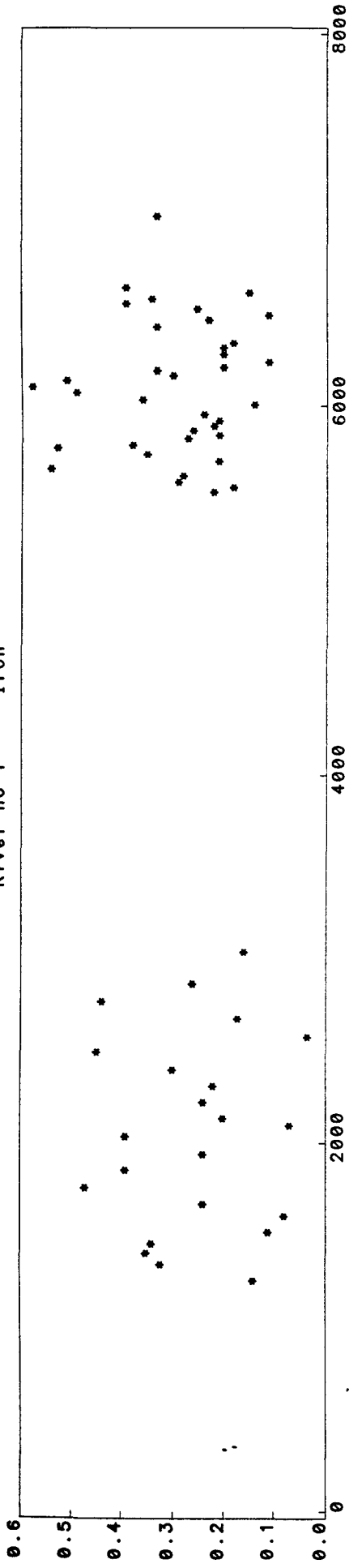

Julian Day  
River no 2 Iron

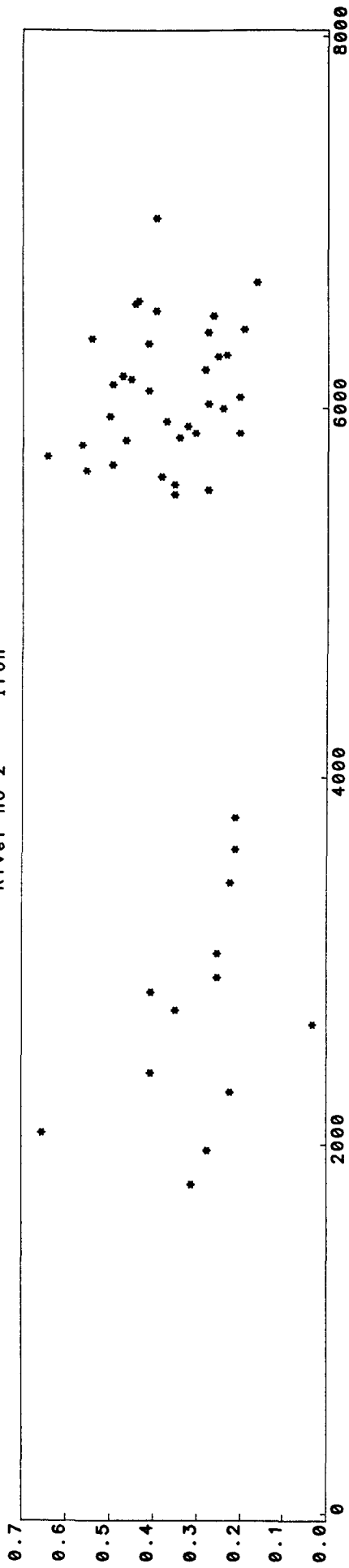

Julian Day  
River no 3 Iron

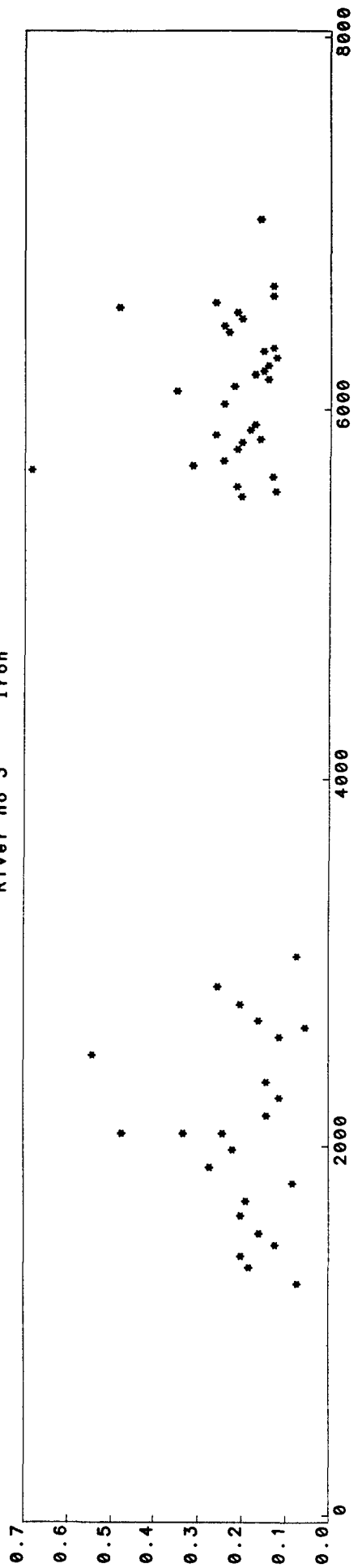

River no 4 Iron

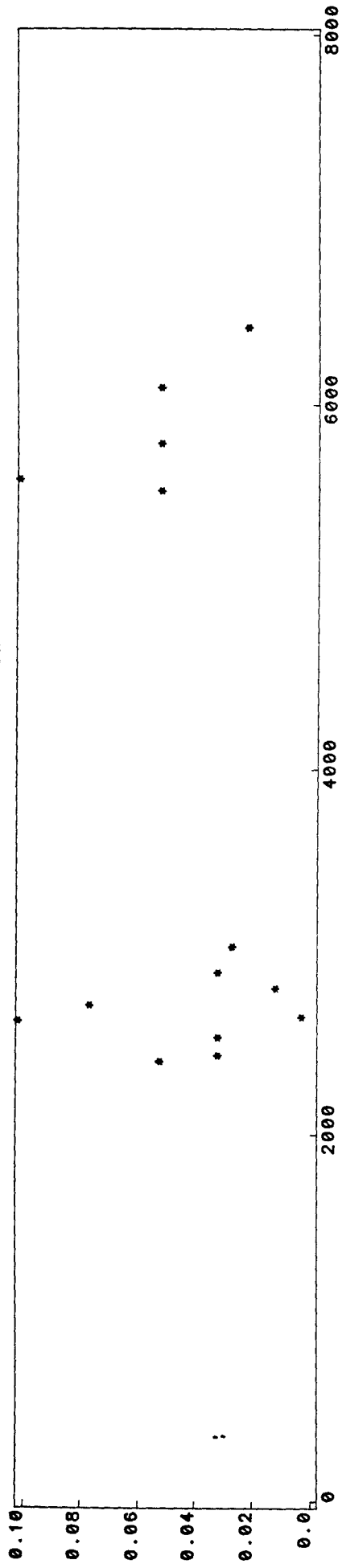

Julian Day  
River no 5 Iron

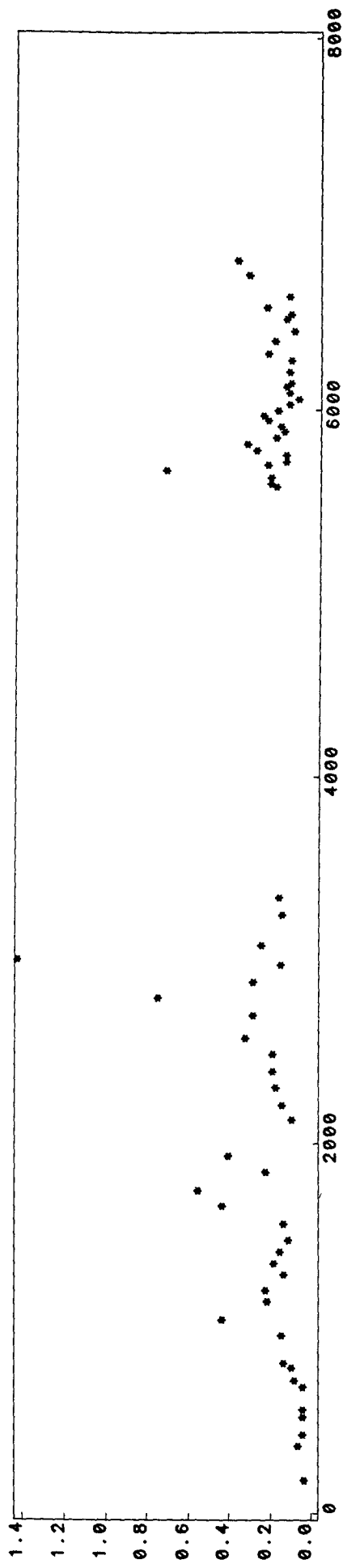

Julian Day  
River no 6 Iron

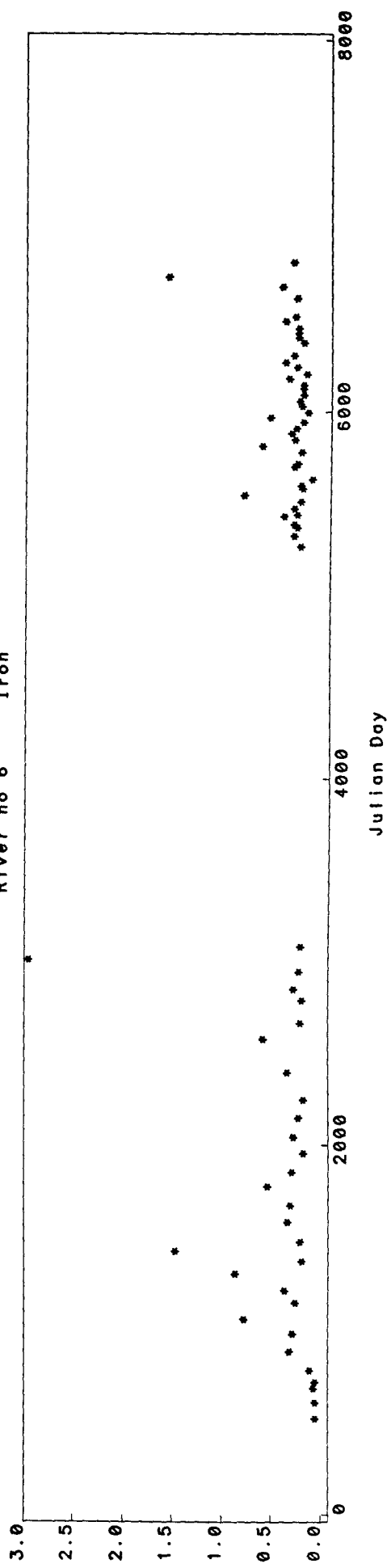

River no 7 Iron

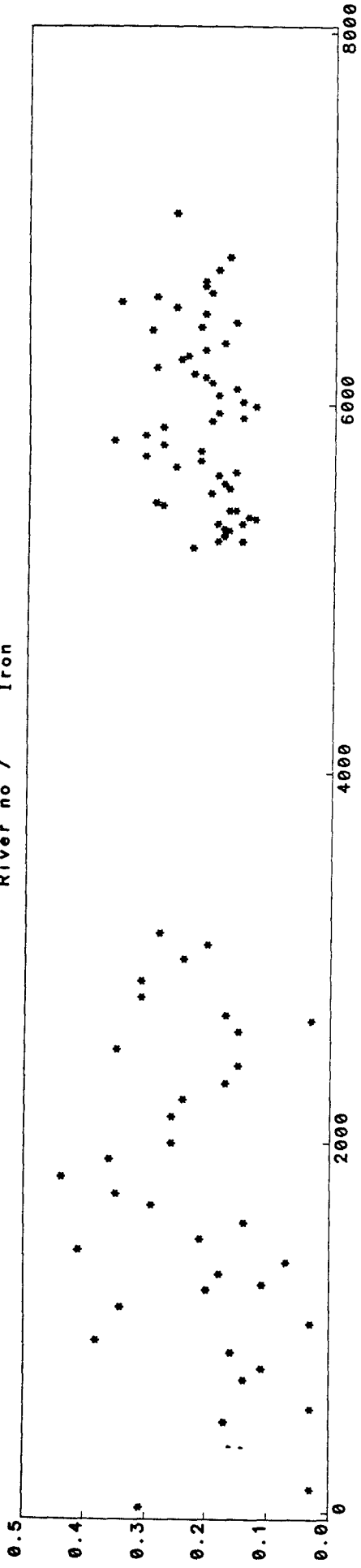

Julian Day  
River no 8 Iron

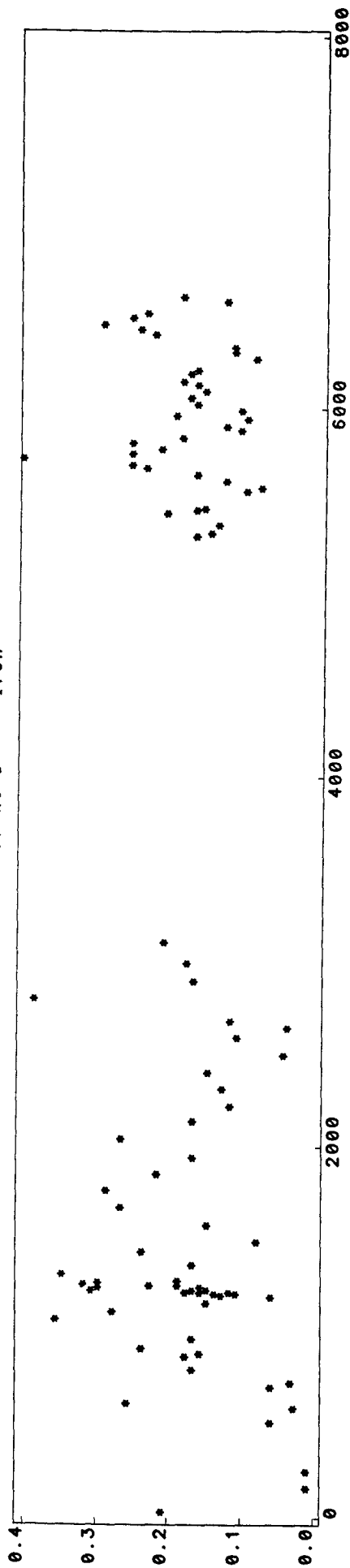

Julian Day  
River no 9 Iron

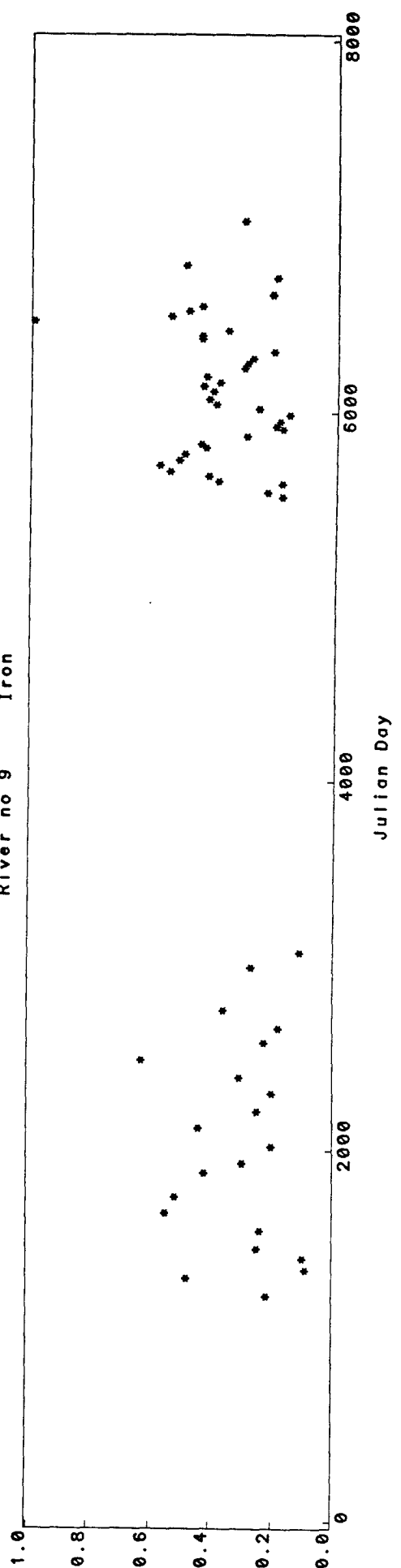

River no 10 Iron

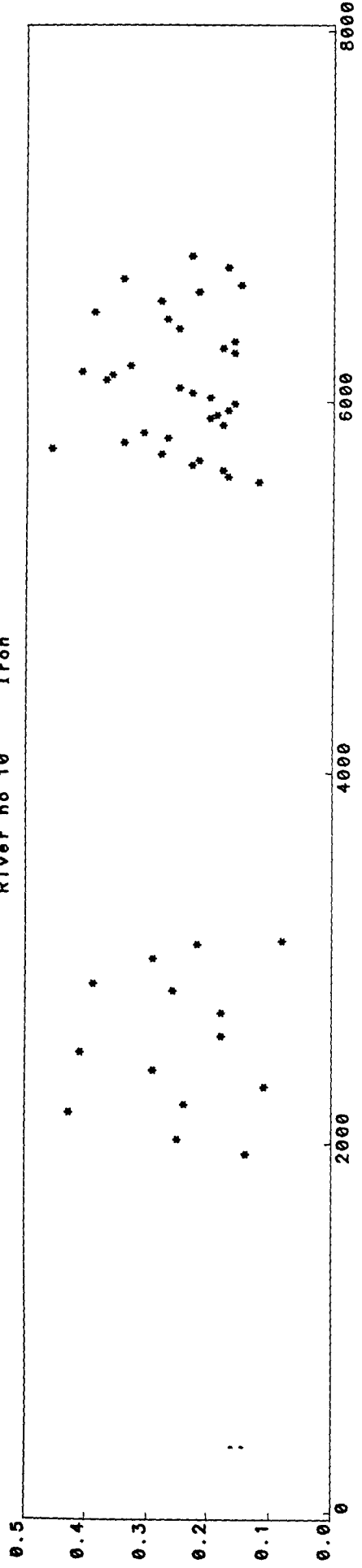

Julian Day  
River no 11 Iron

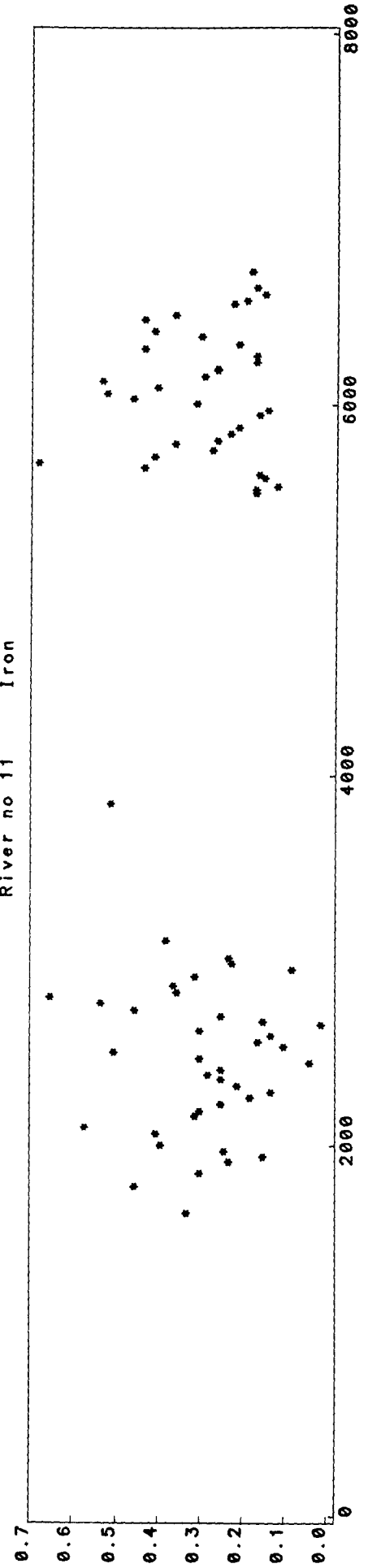

Julian Day  
River no 12 Iron

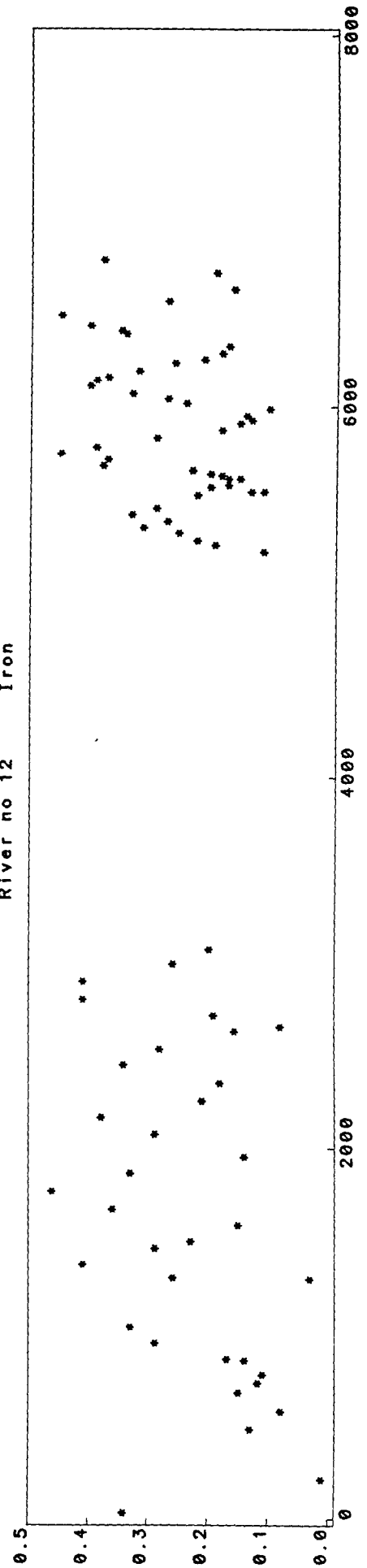

River no 13 Iron

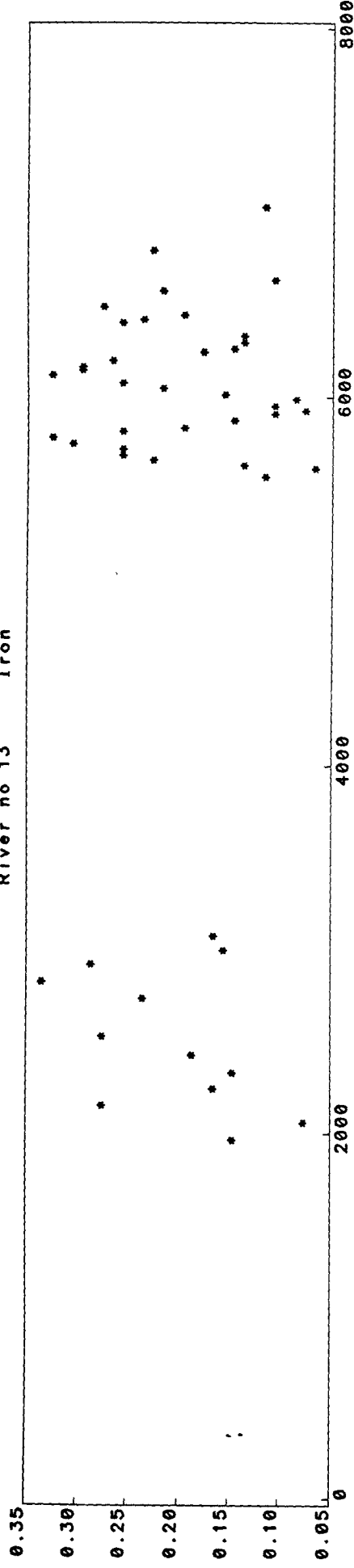

Julian Day  
River no 16 Iron

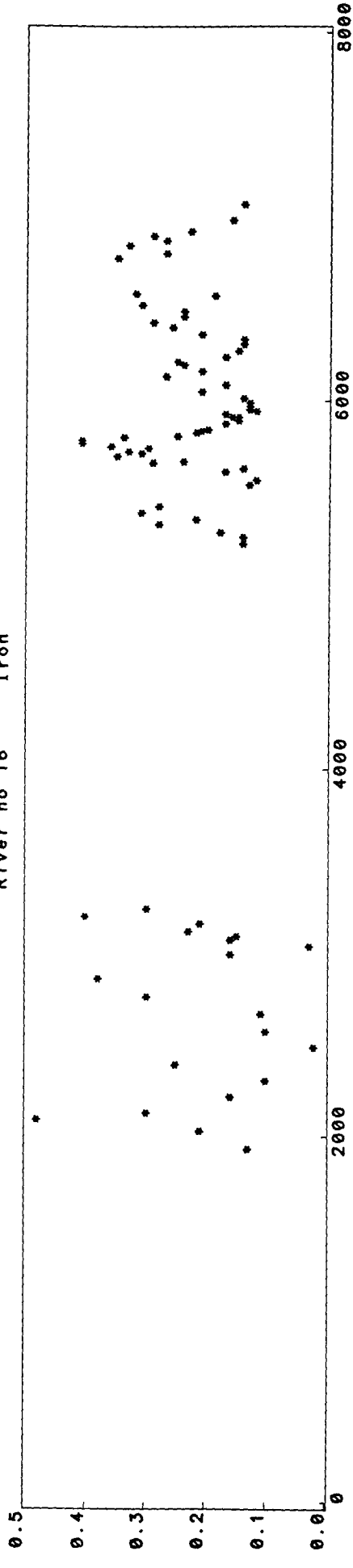

Julian Day  
River no 17 Iron

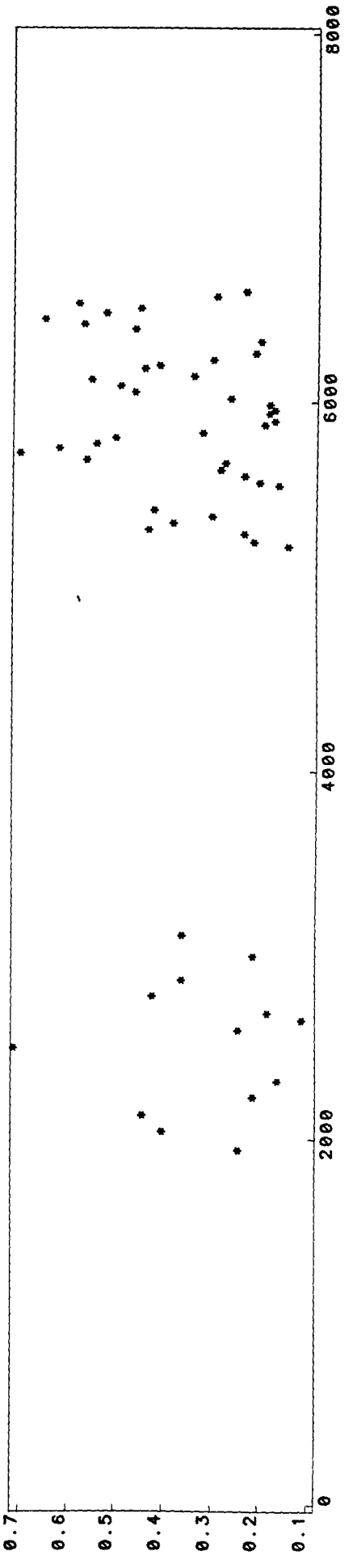

River no 18 Iron

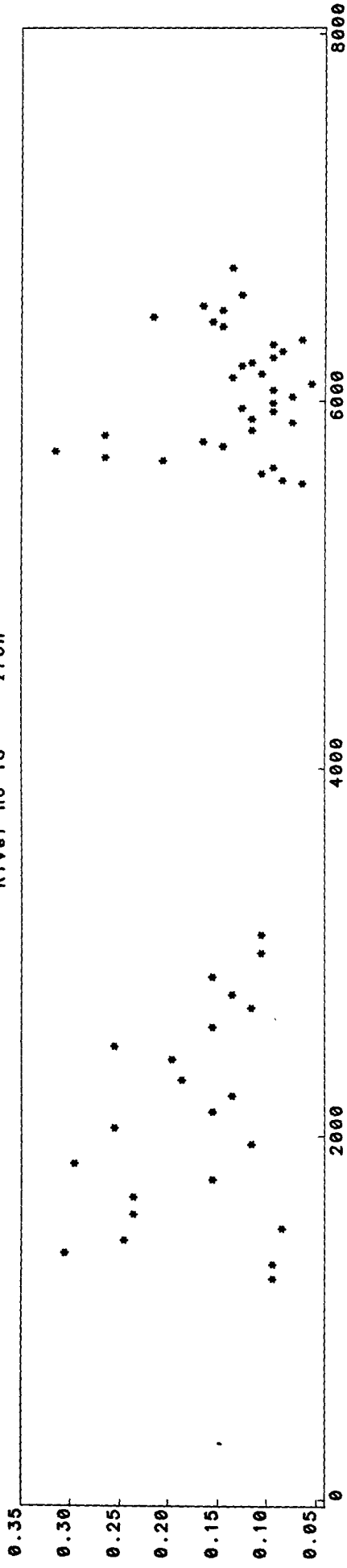

Julian Day  
River no 19 Iron

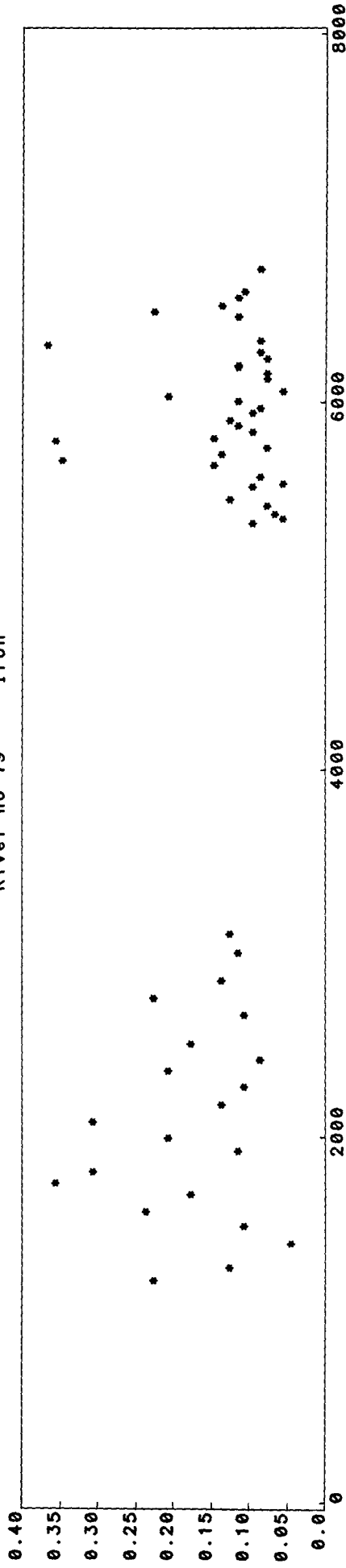

Julian Day  
River no 20 Iron

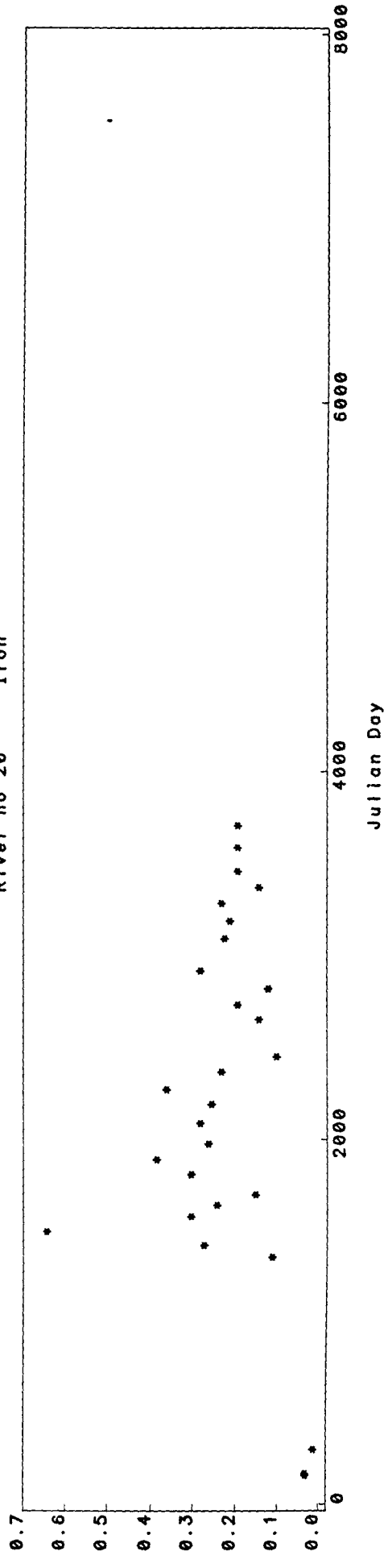

River no 21 Iron

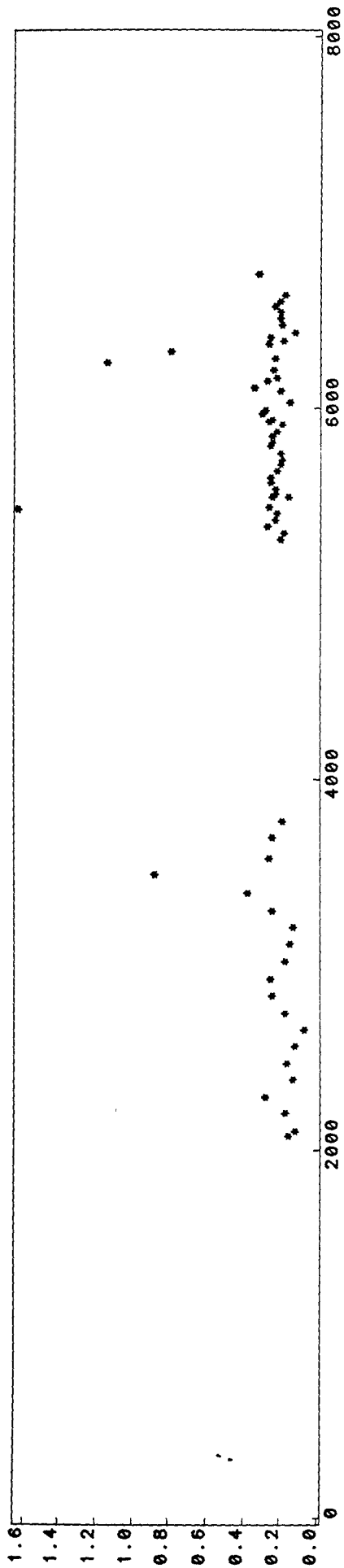

Julian Day  
River no 22 Iron

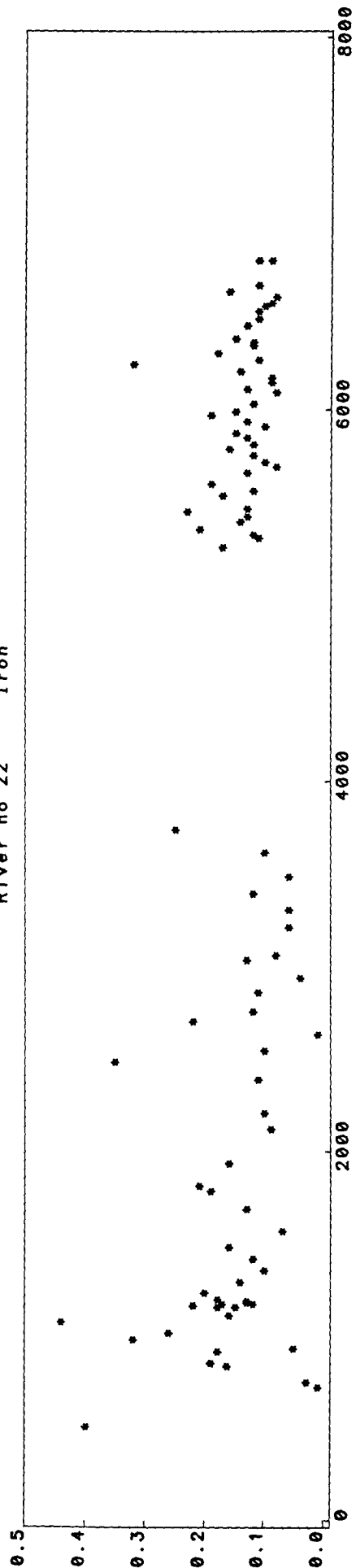

Julian Day  
River no 23 Iron

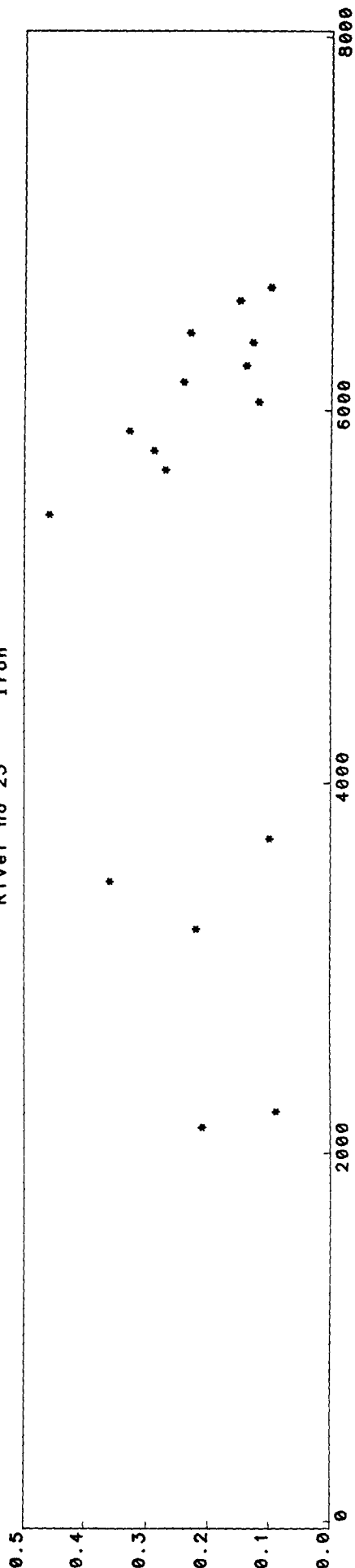

River no 25 Iron

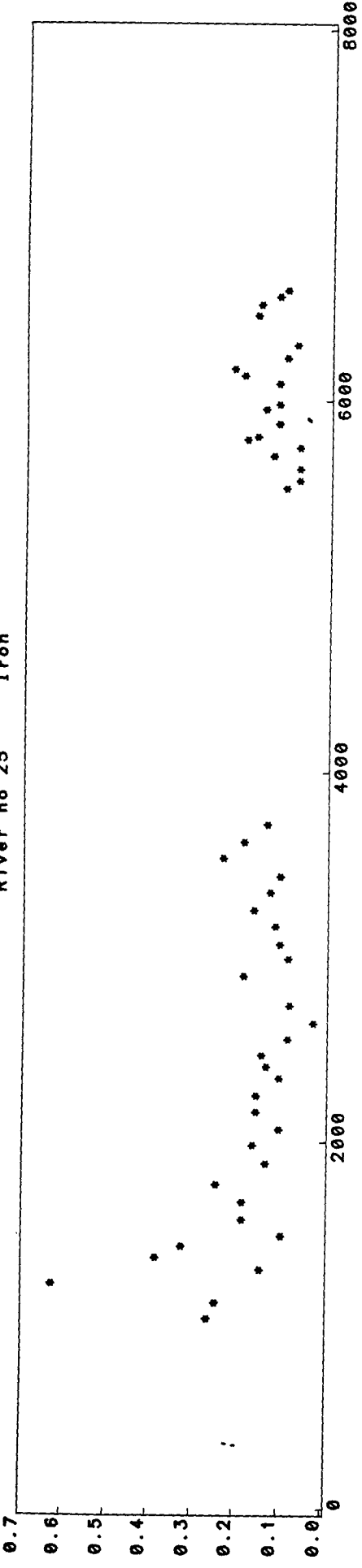

Julian Day  
River no 26 Iron

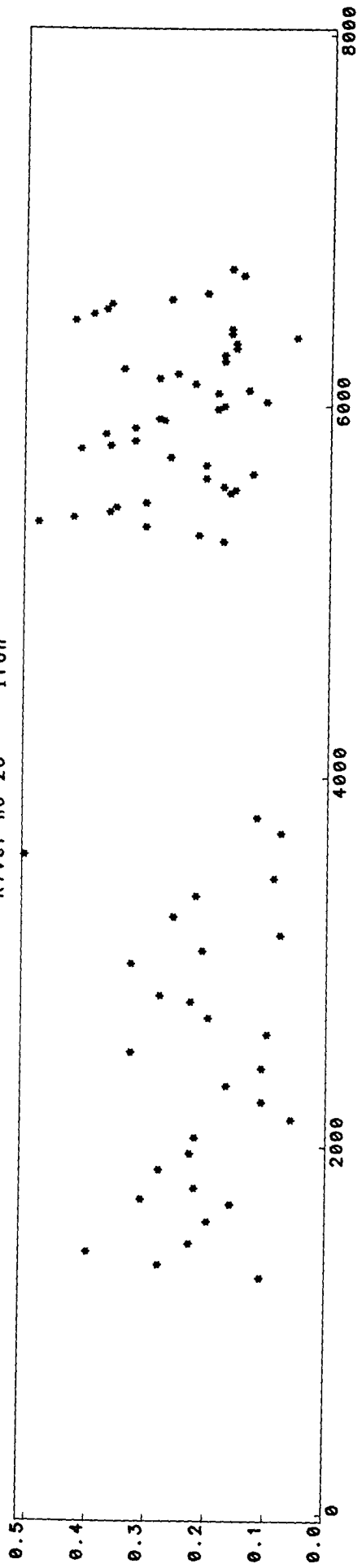

Julian Day  
River no 27 Iron

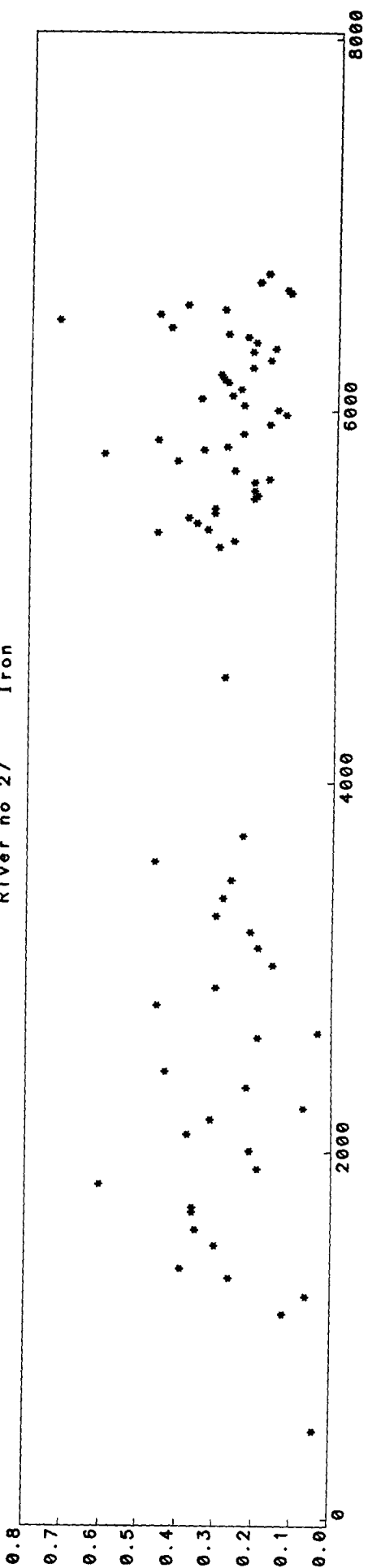



River no 28 Iron

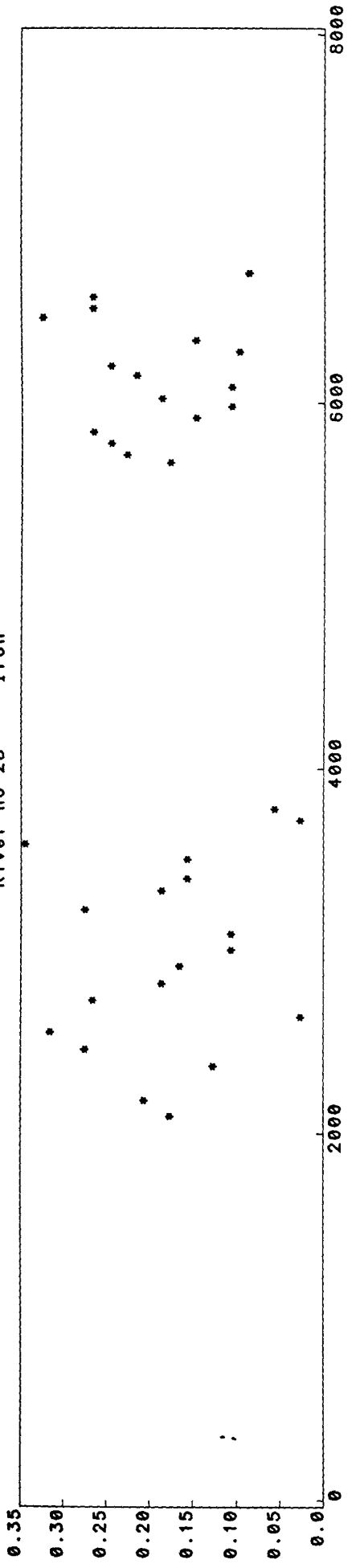

Appendix 5. Scatter plots of magnesium for the study rivers.

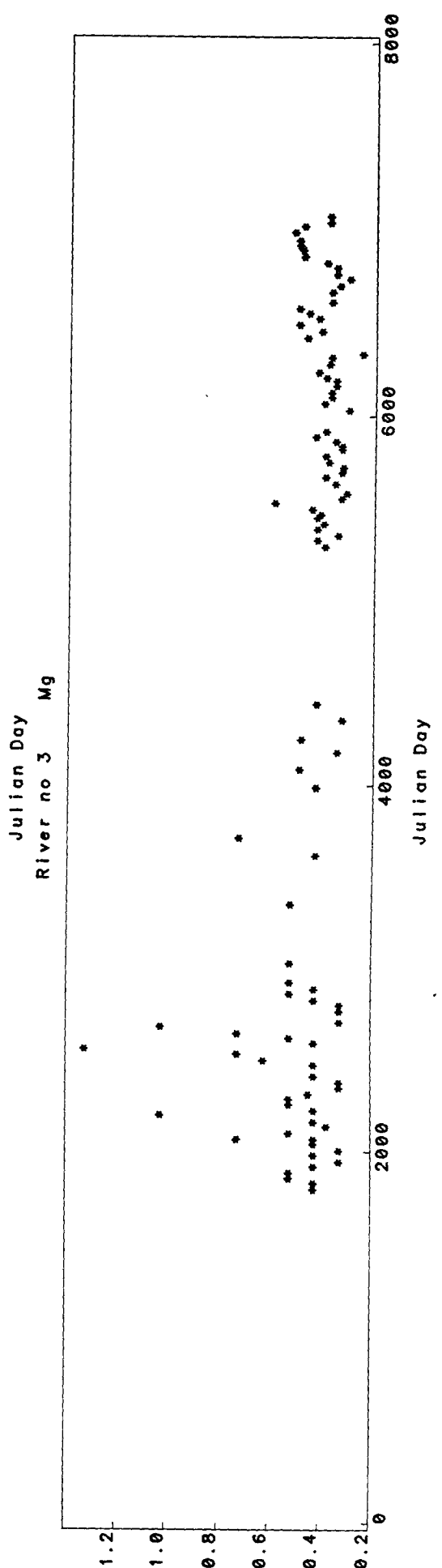
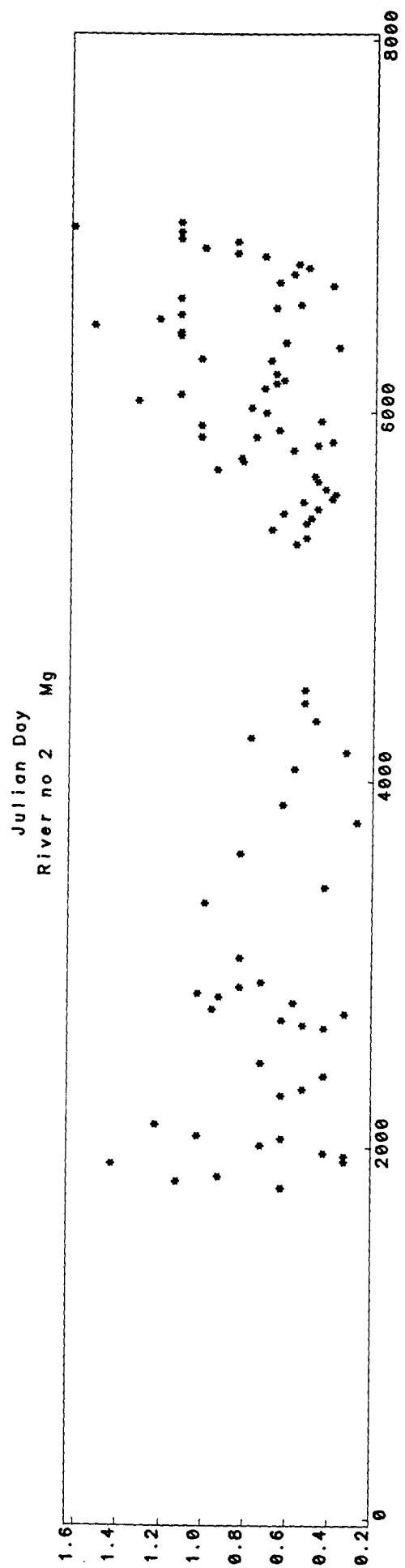
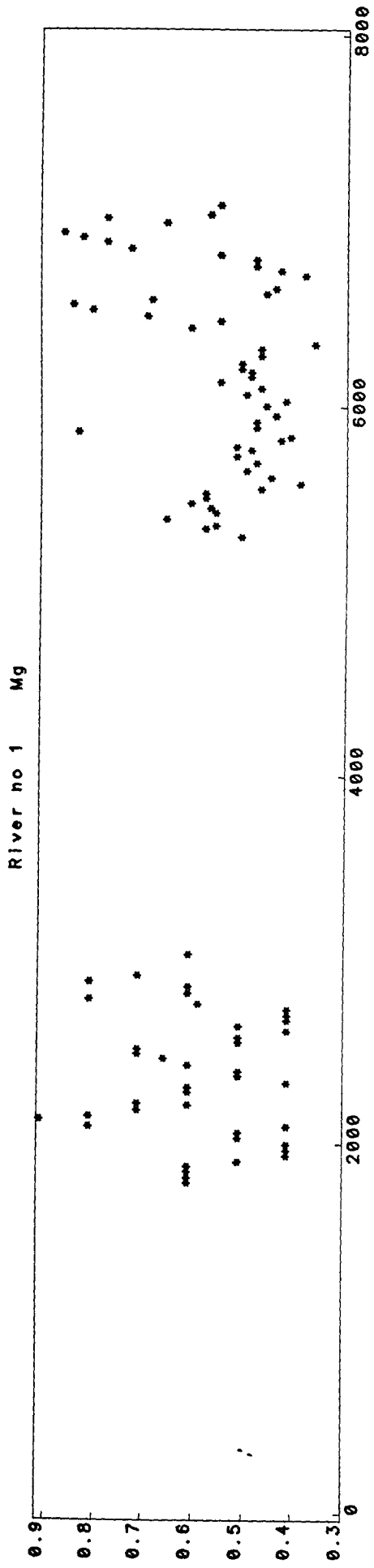

River no 4 Mg

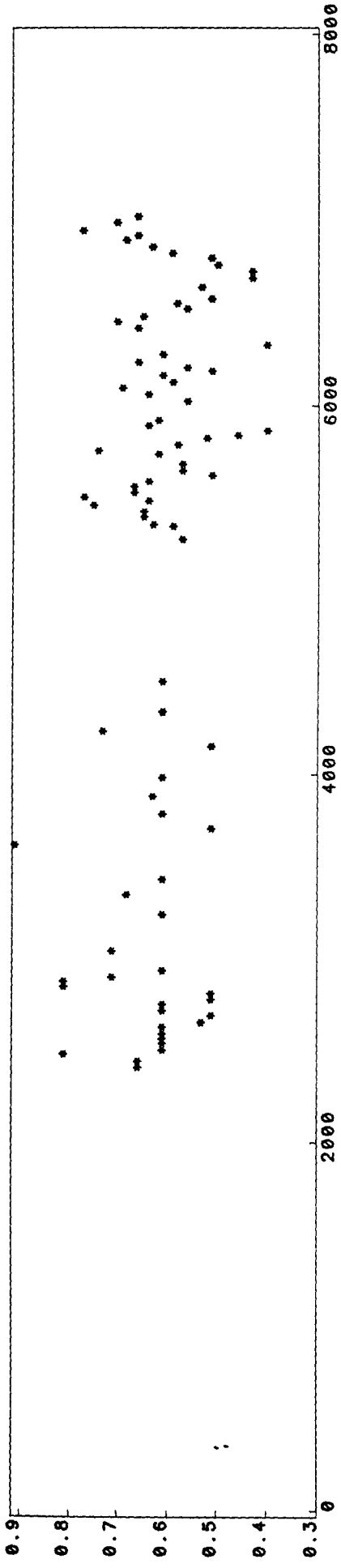

Julian Day  
River no 5 Mg

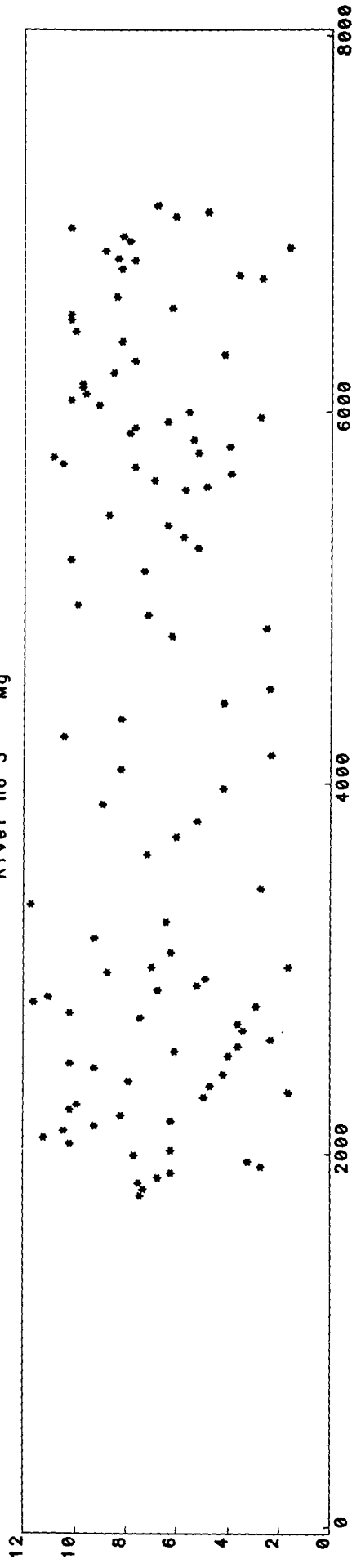

Julian Day  
River no 6 Mg

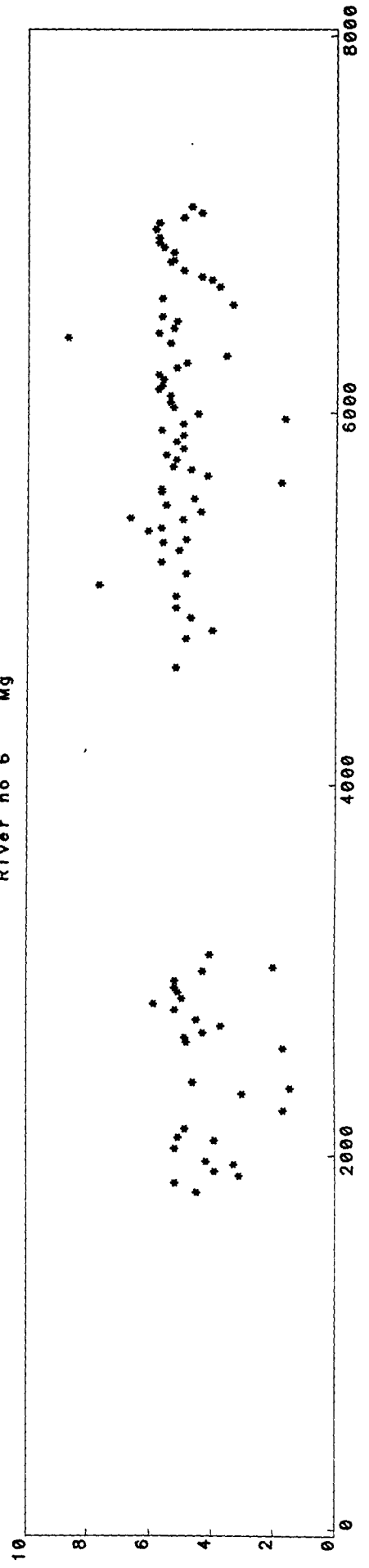

River no 7 Mg

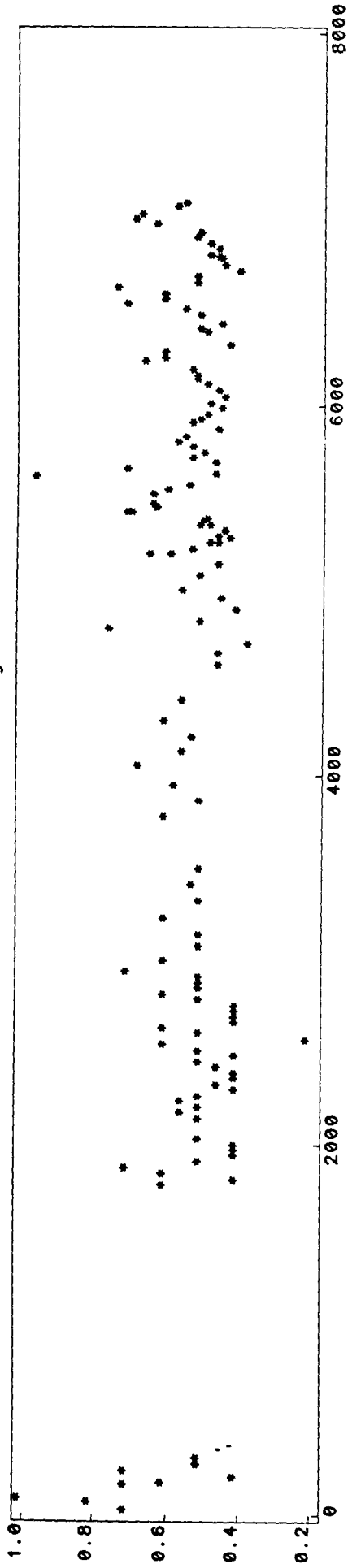

Julian Day  
River no 8 Mg

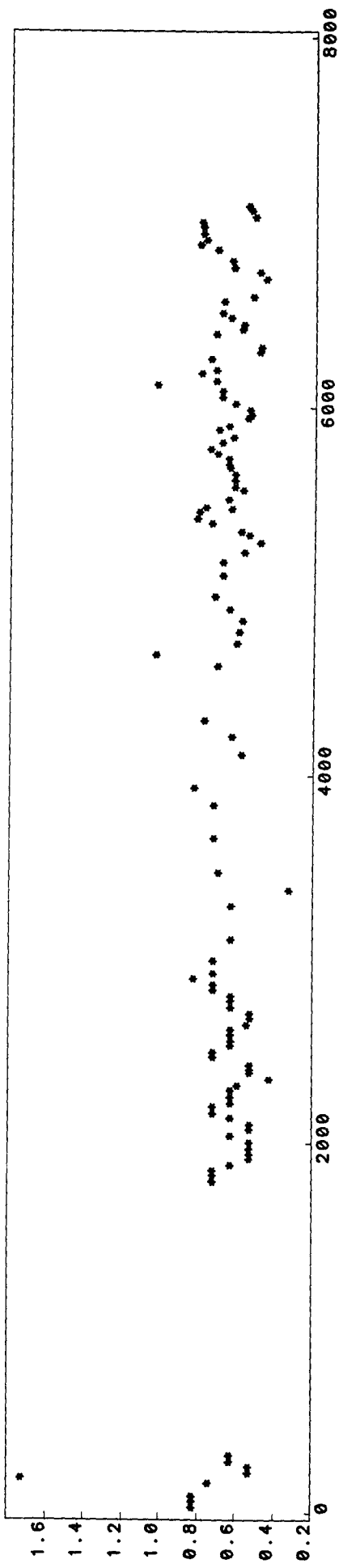

Julian Day  
River no 9 Mg

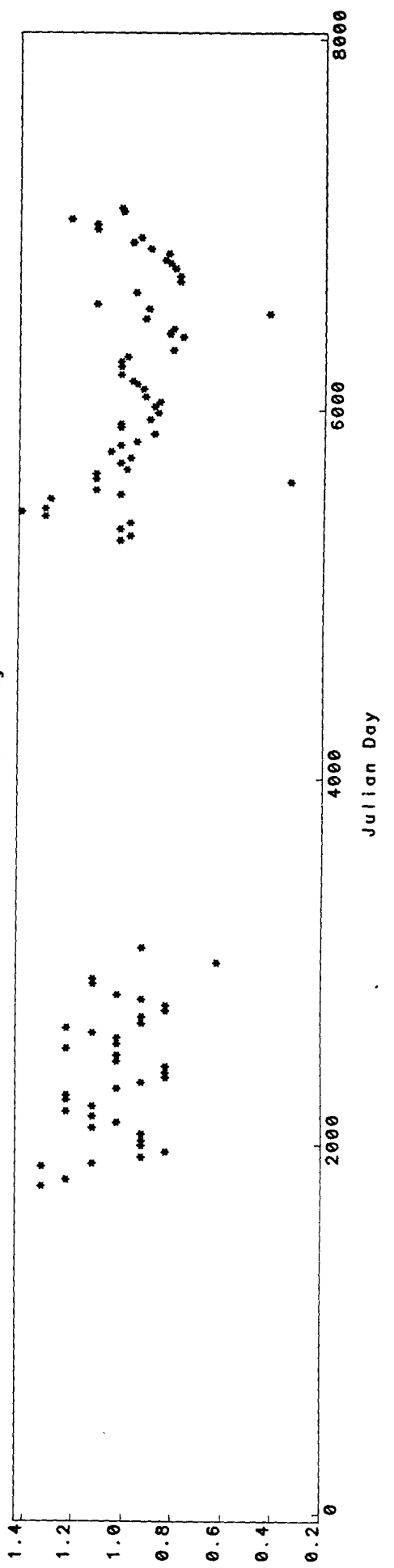

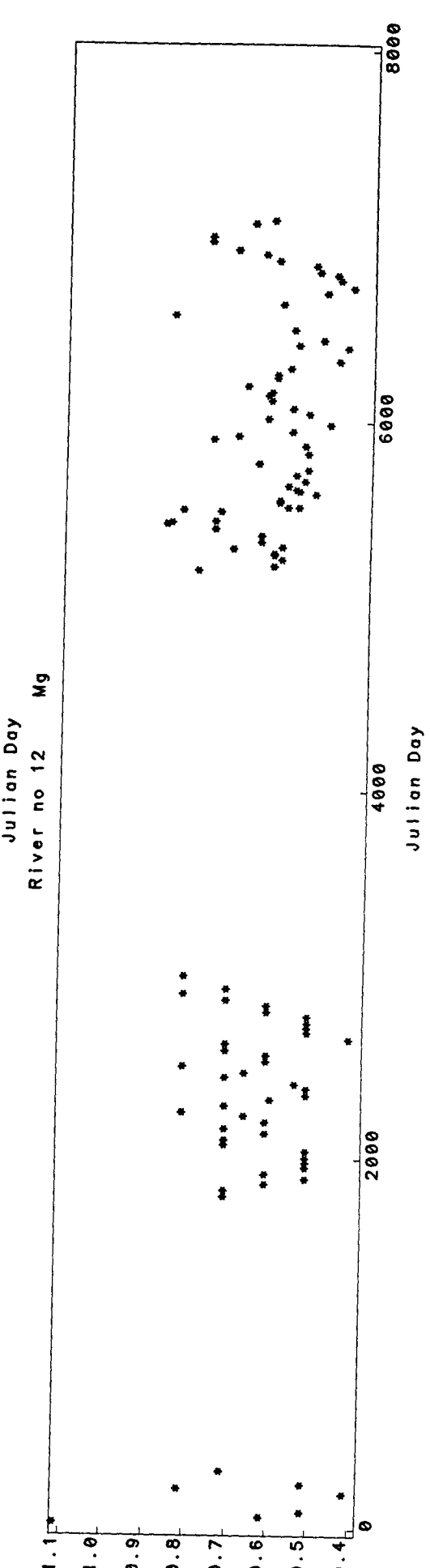
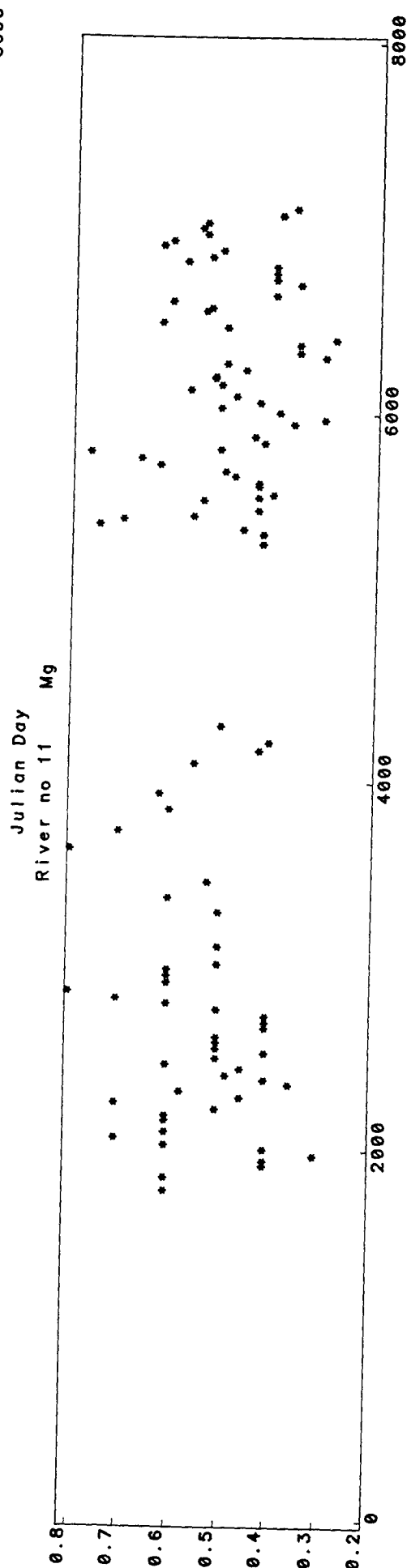
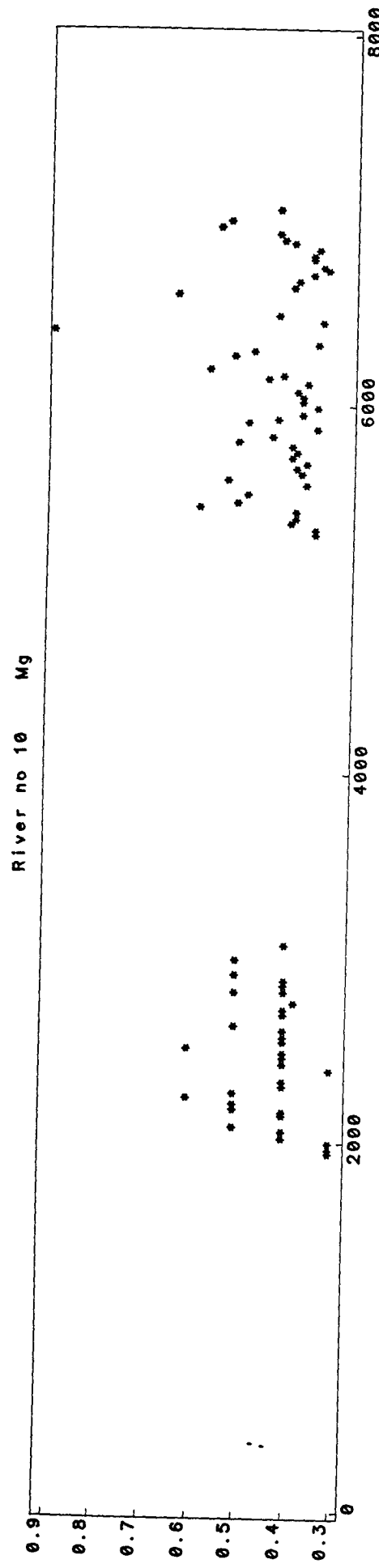

River no 13 Mg

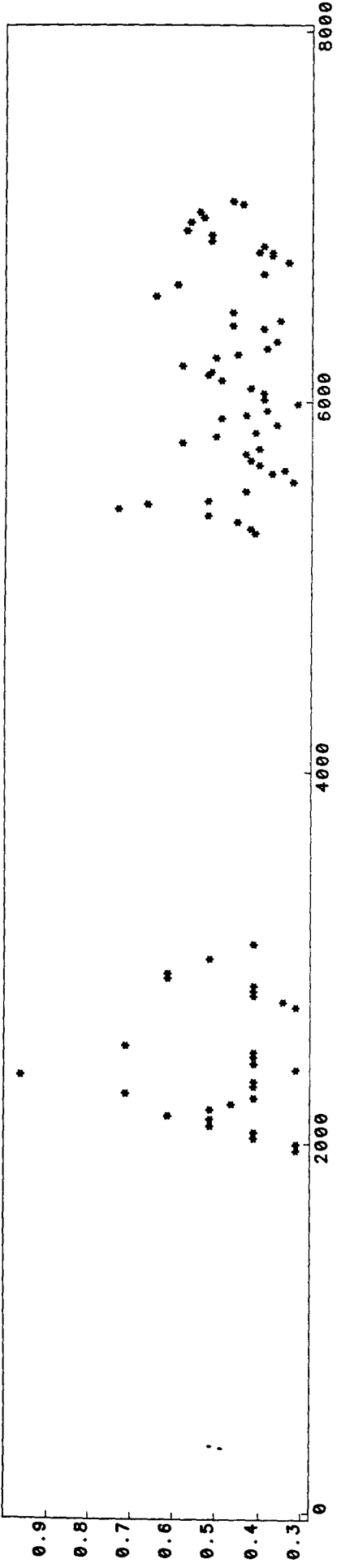

Julian Day  
River no 16 Mg

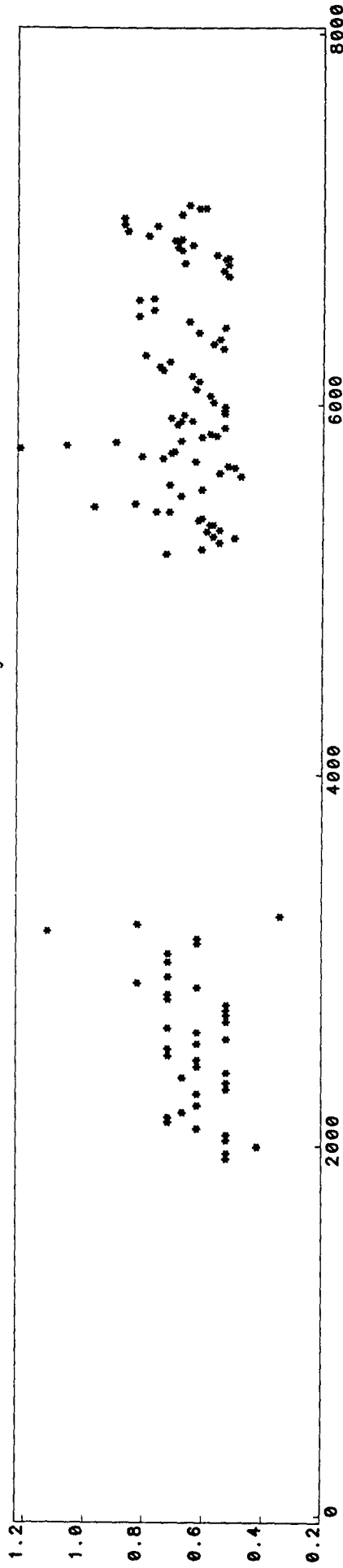

Julian Day  
River no 17 Mg

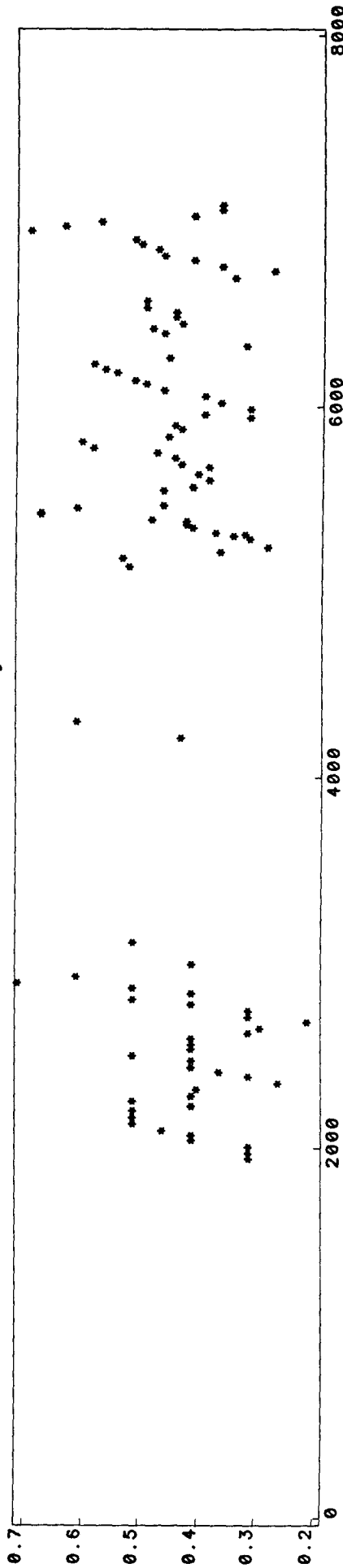

River no 18 Mg

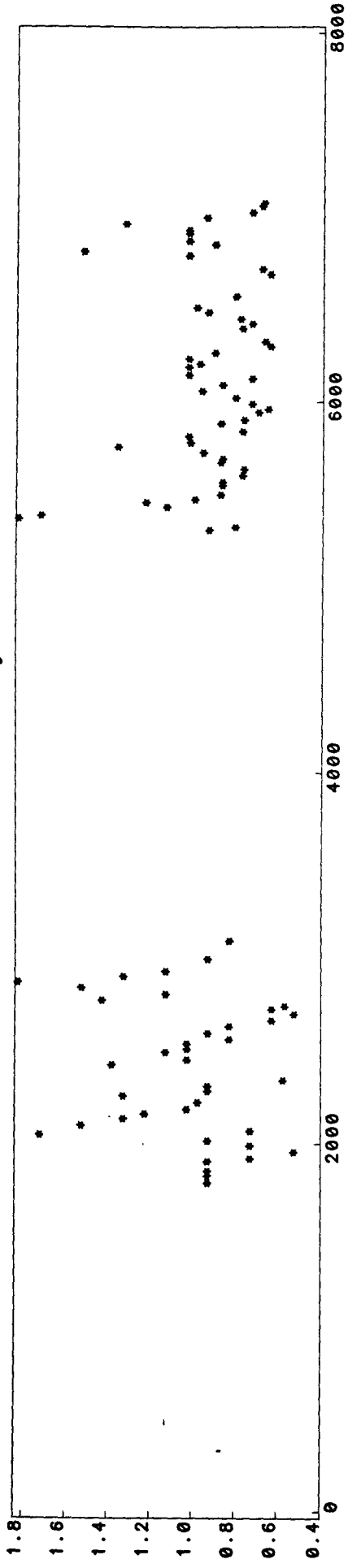

Julian Day  
River no 19 Mg

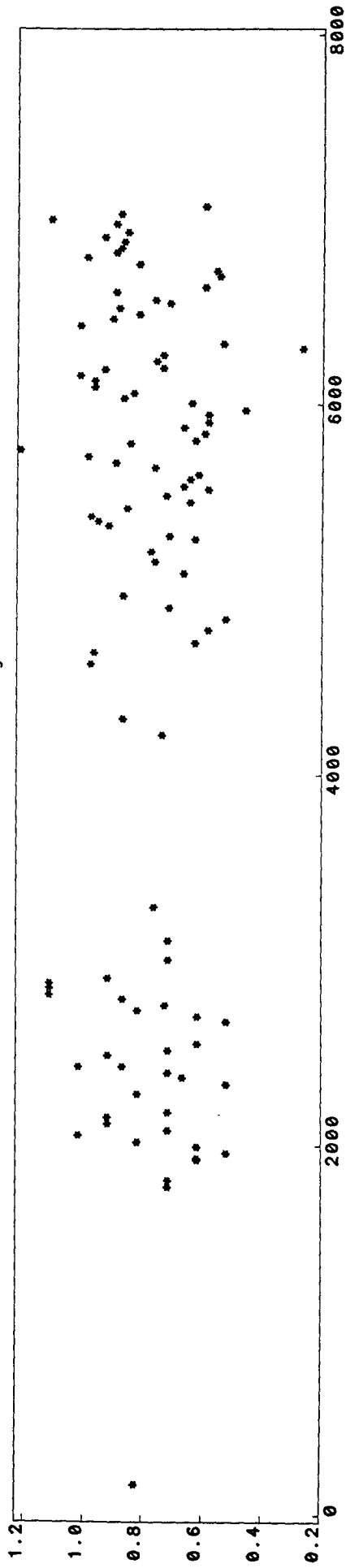

Julian Day  
River no 20 Mg

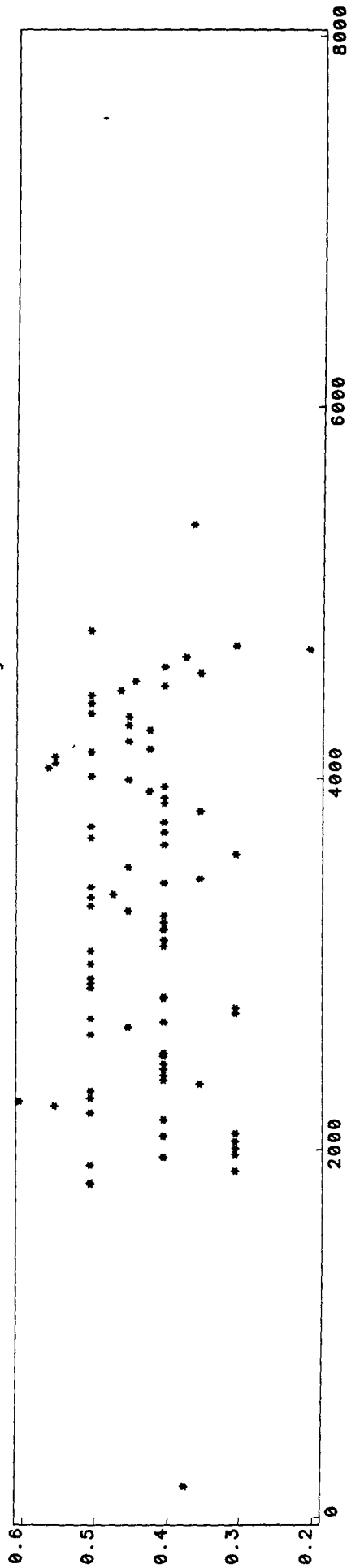



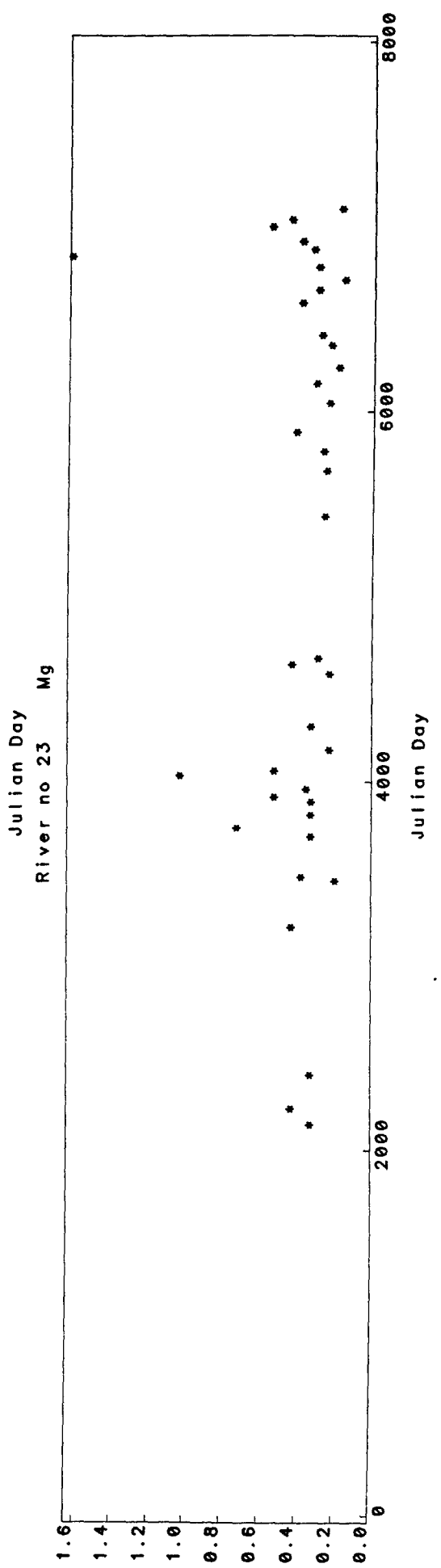
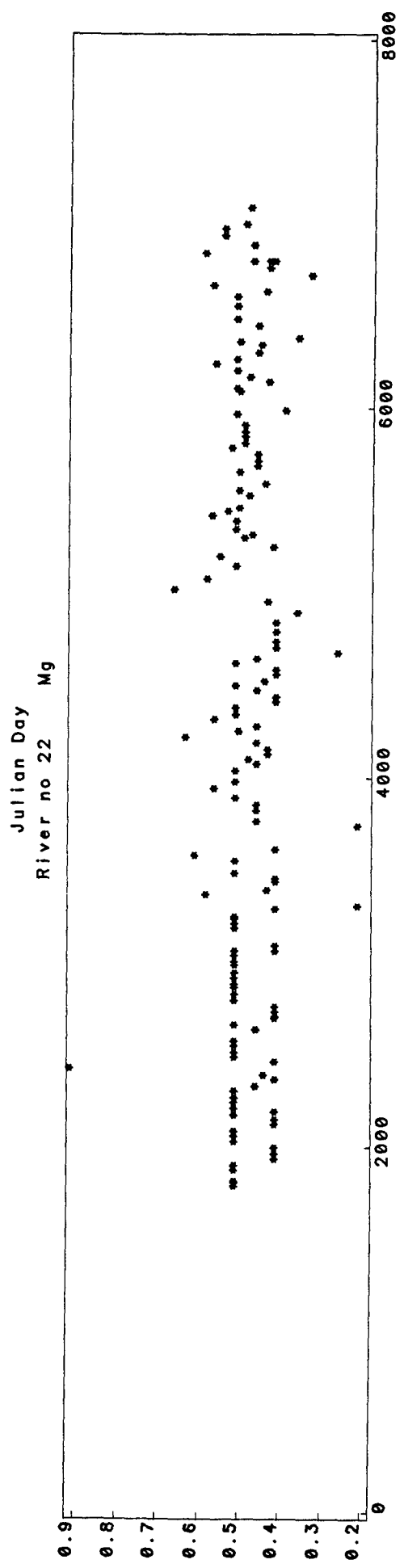
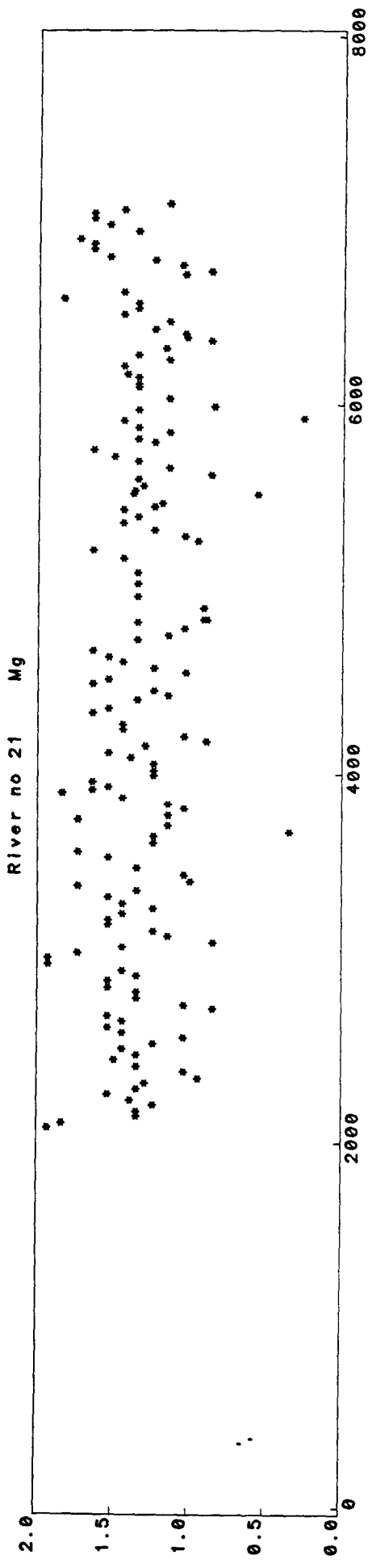

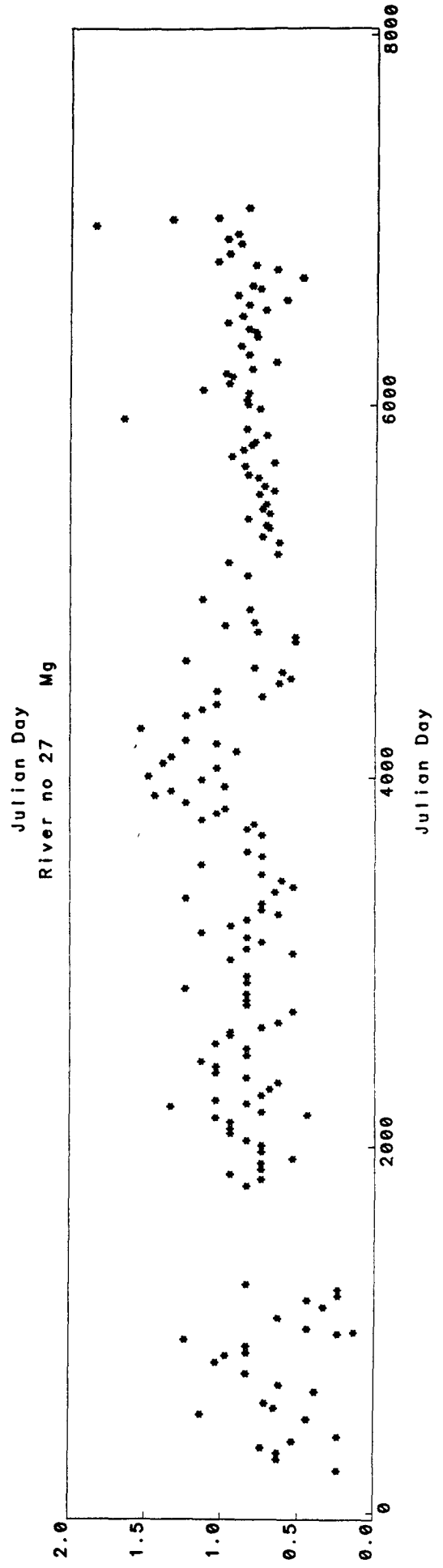
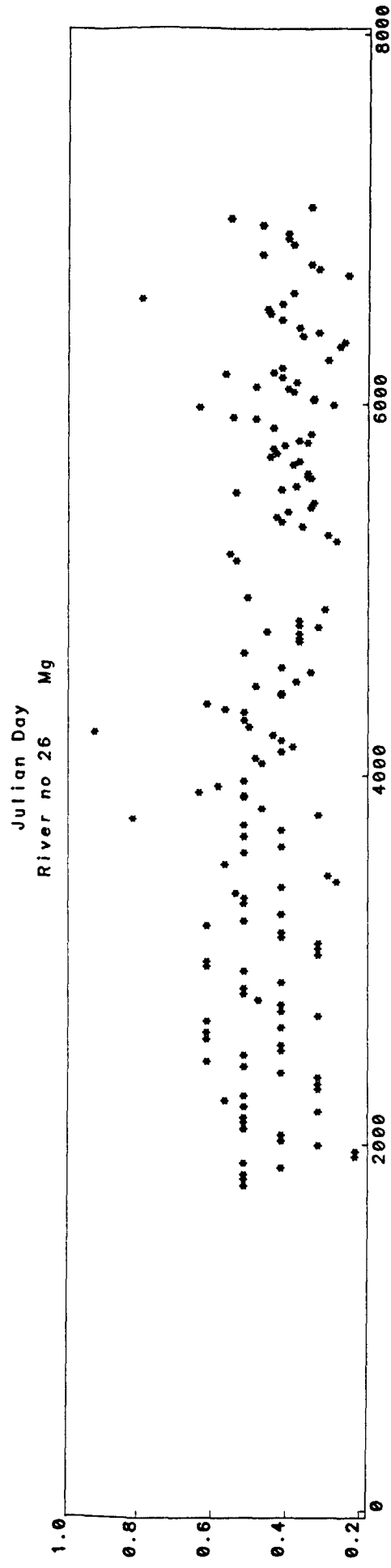
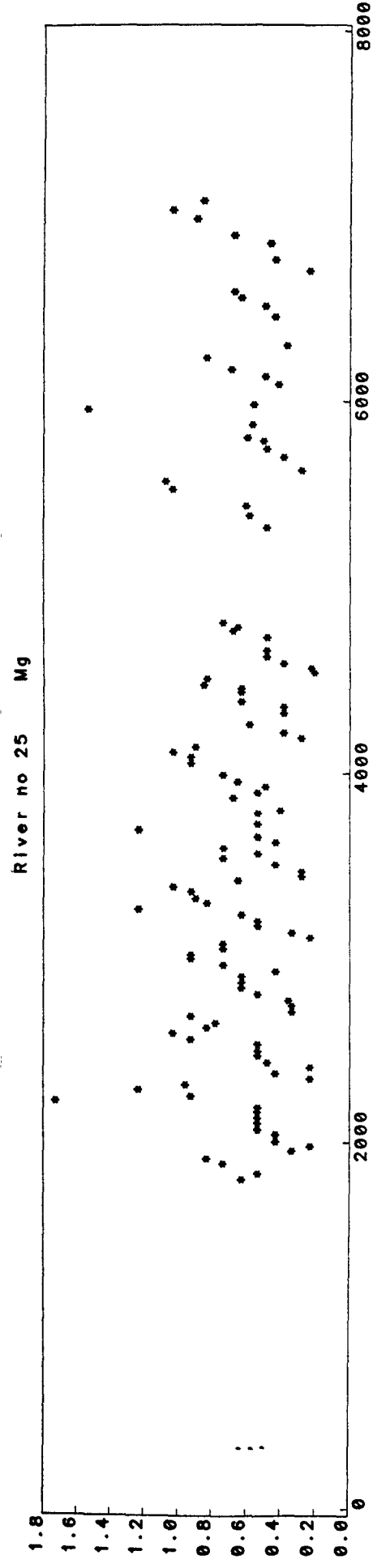

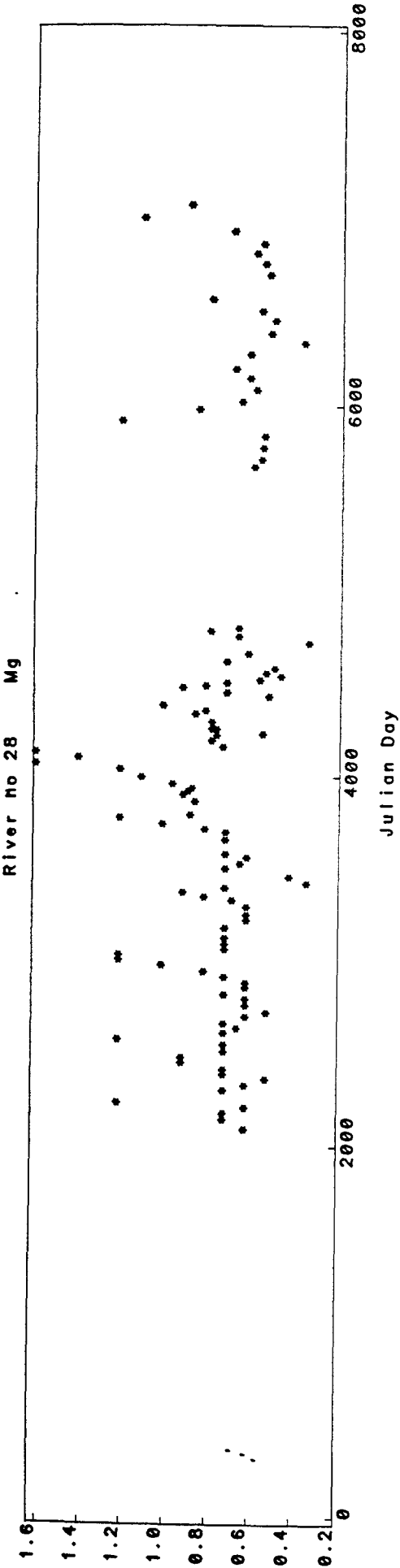

Appendix 6. Scatter plots of conductivity for the study rivers.

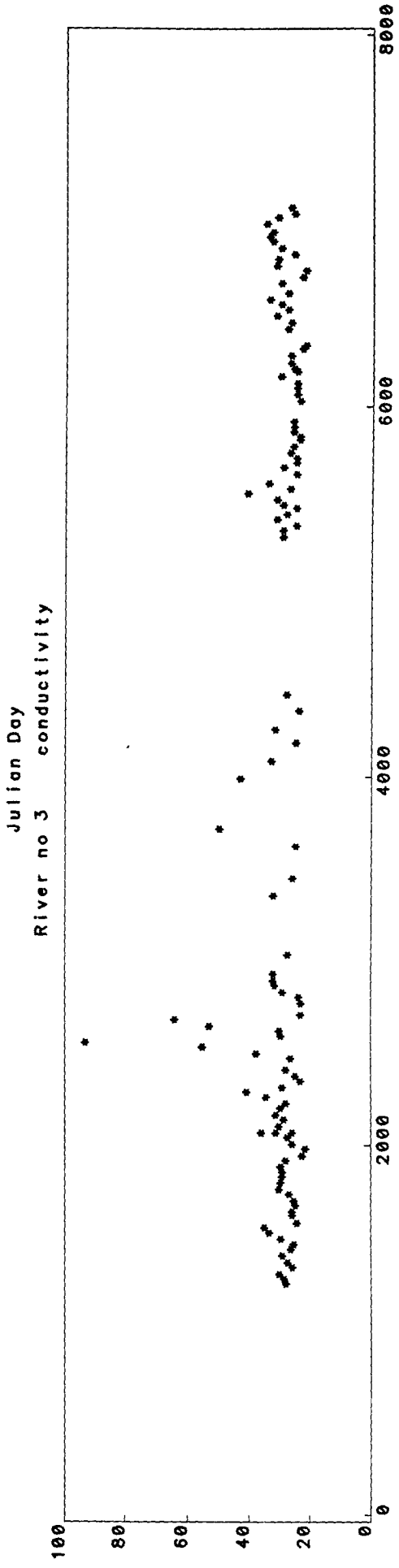
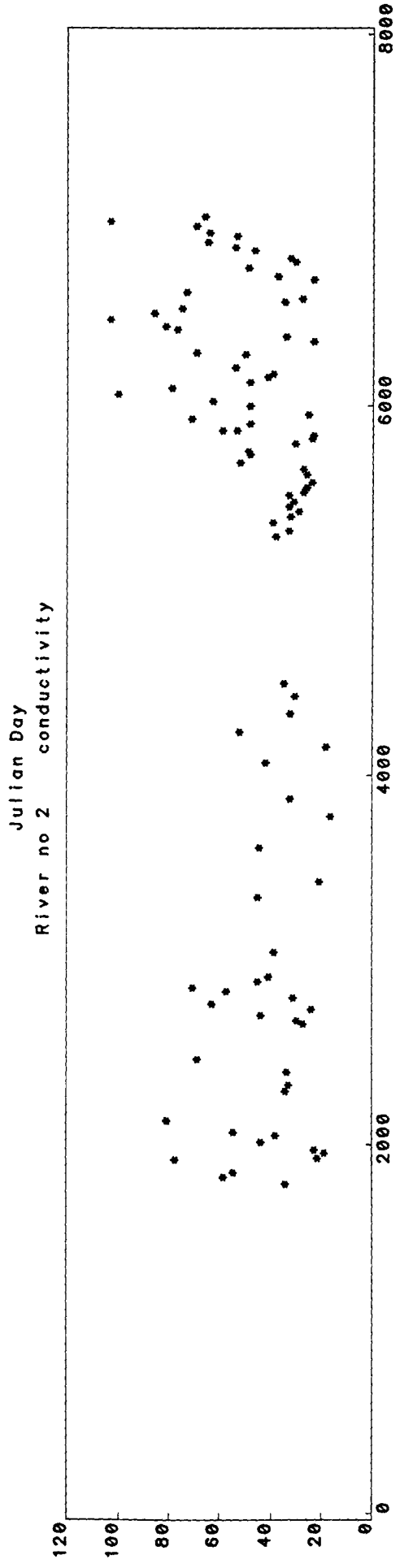
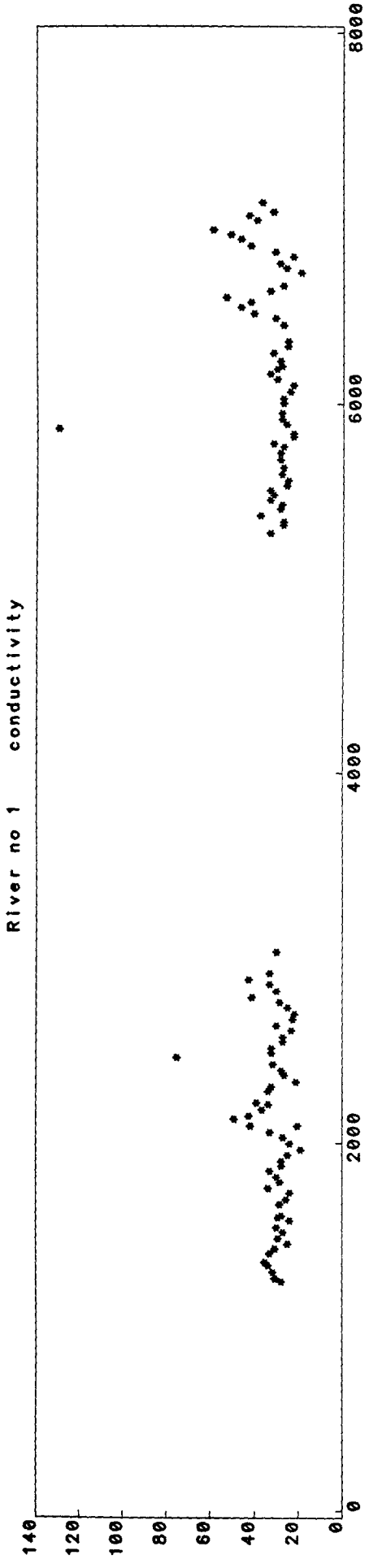

River no 4 conductivity

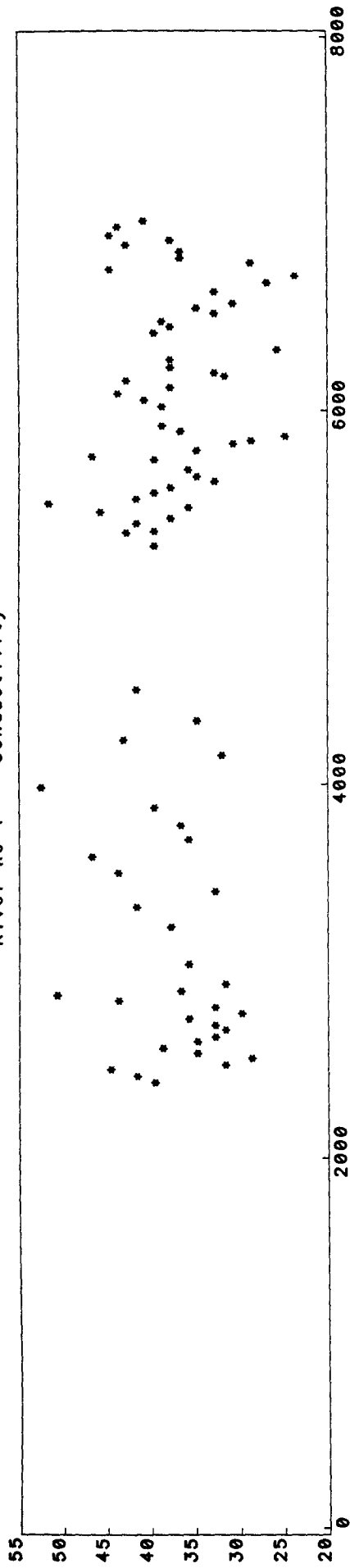

River no 5 conductivity

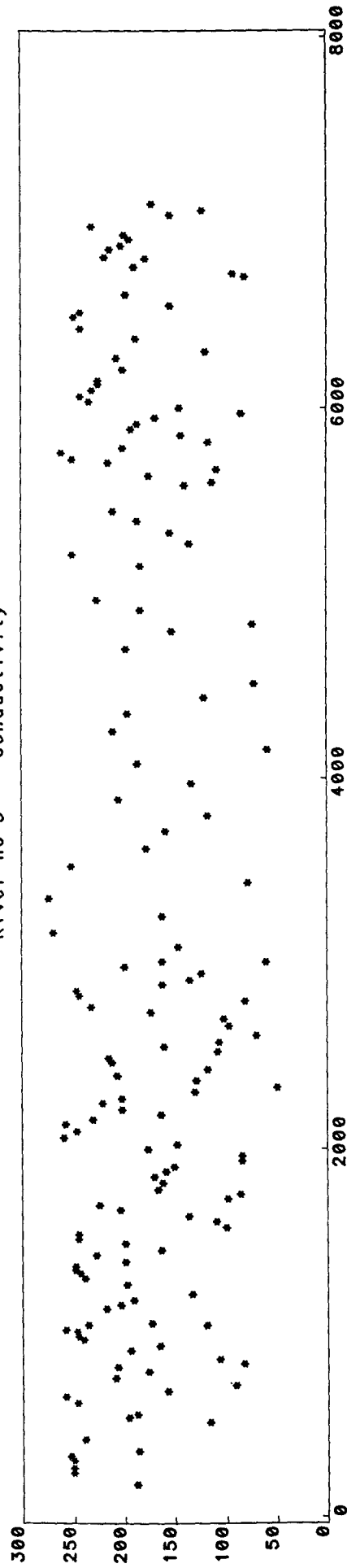

River no 6 conductivity

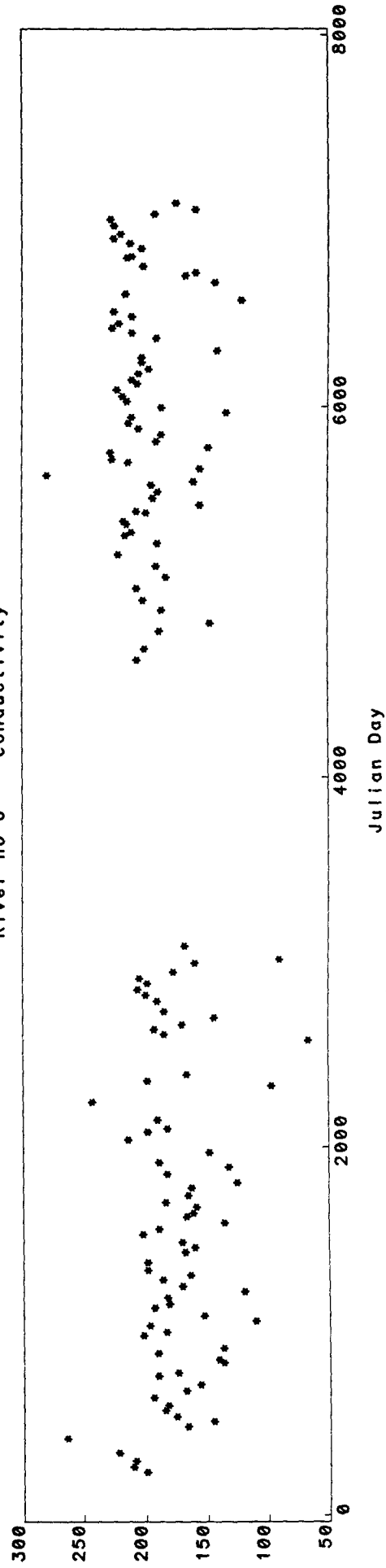

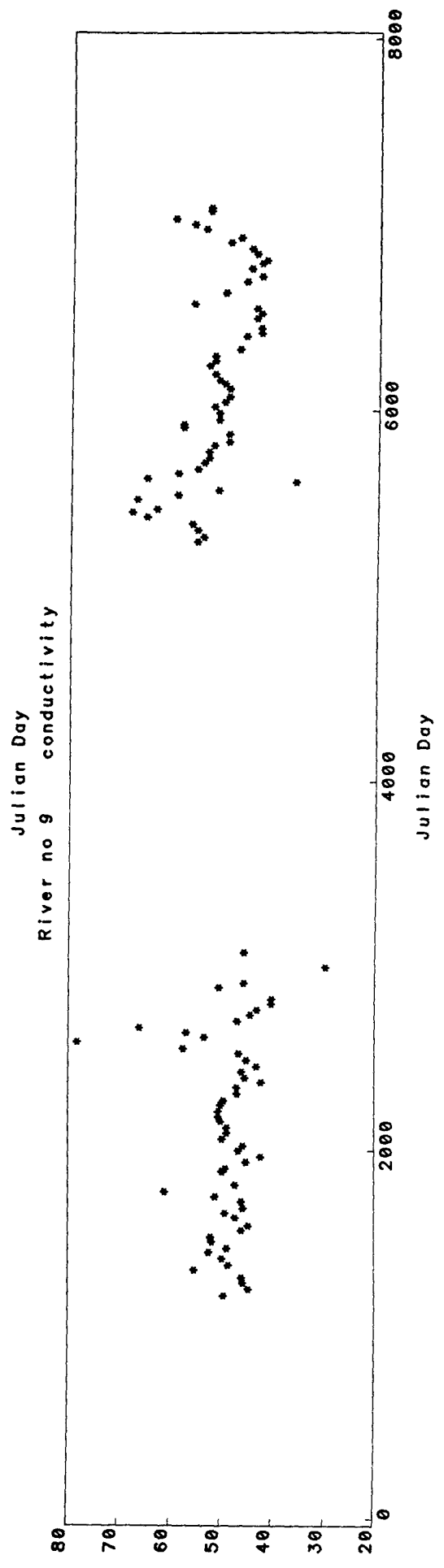
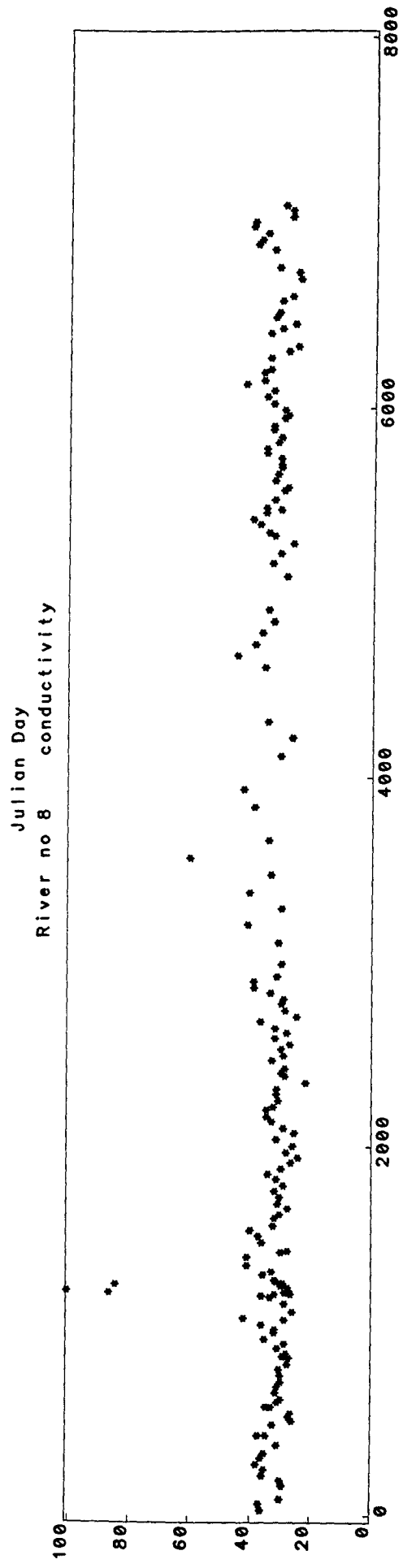
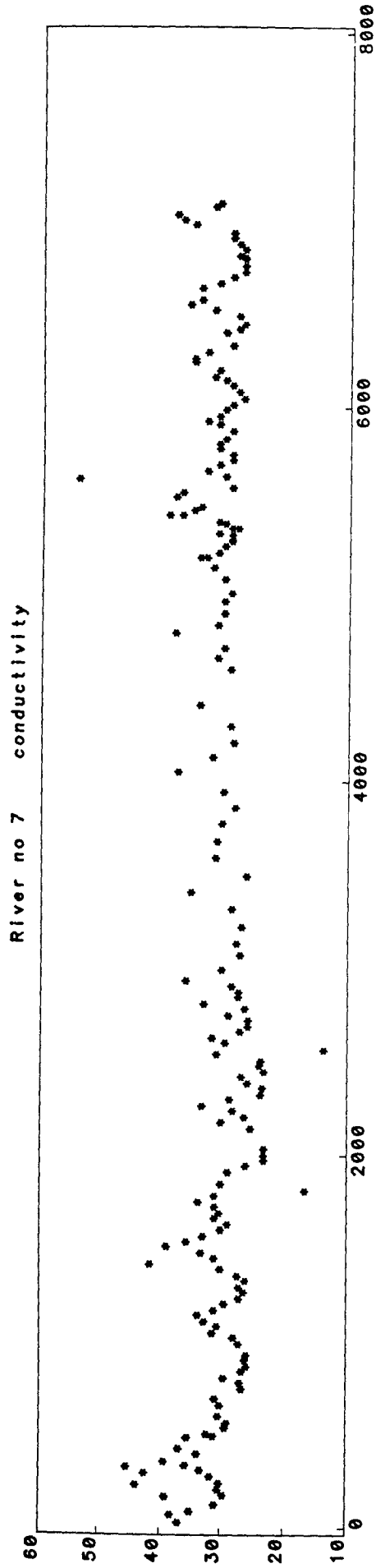

River no 10 conductivity

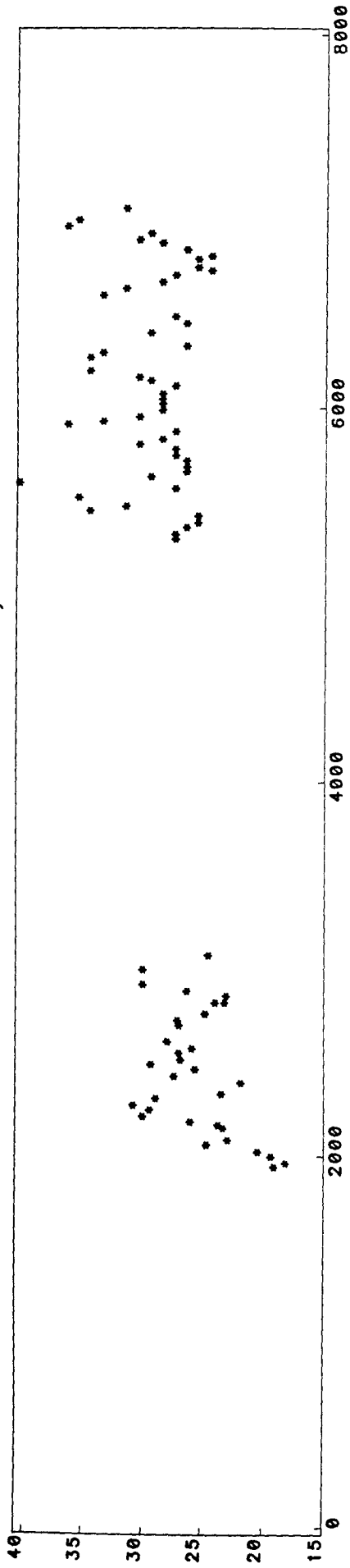

River no 11 conductivity

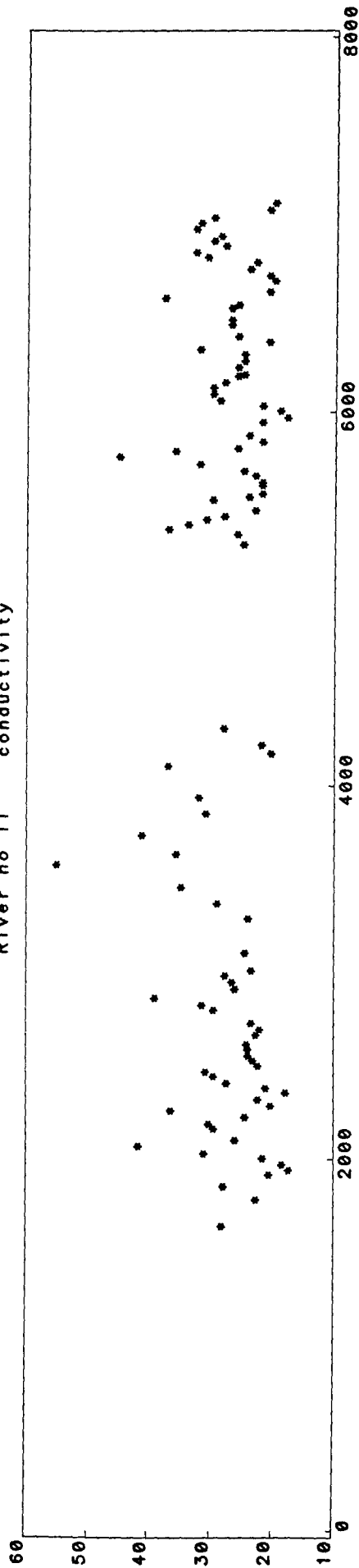

River no 12 conductivity

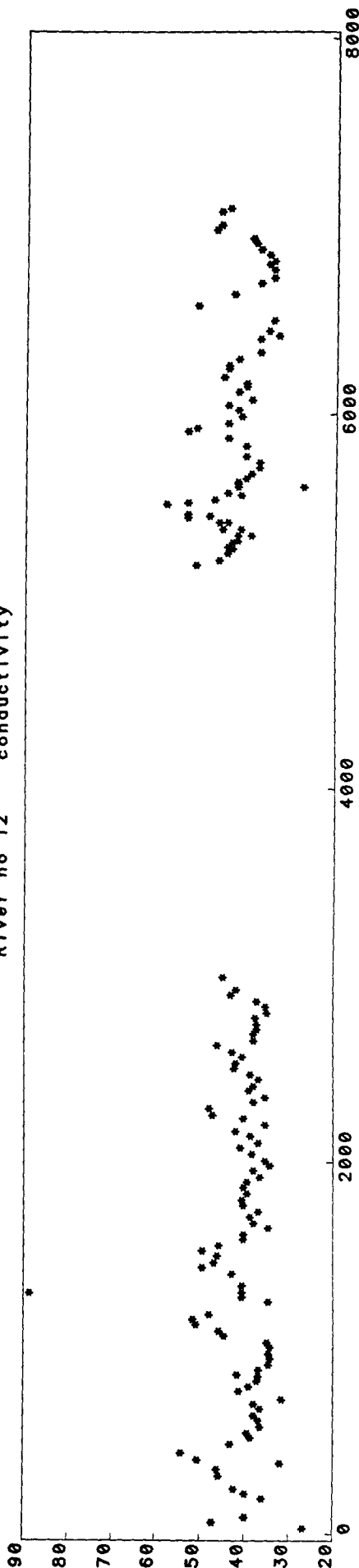



River no 13 conductivity

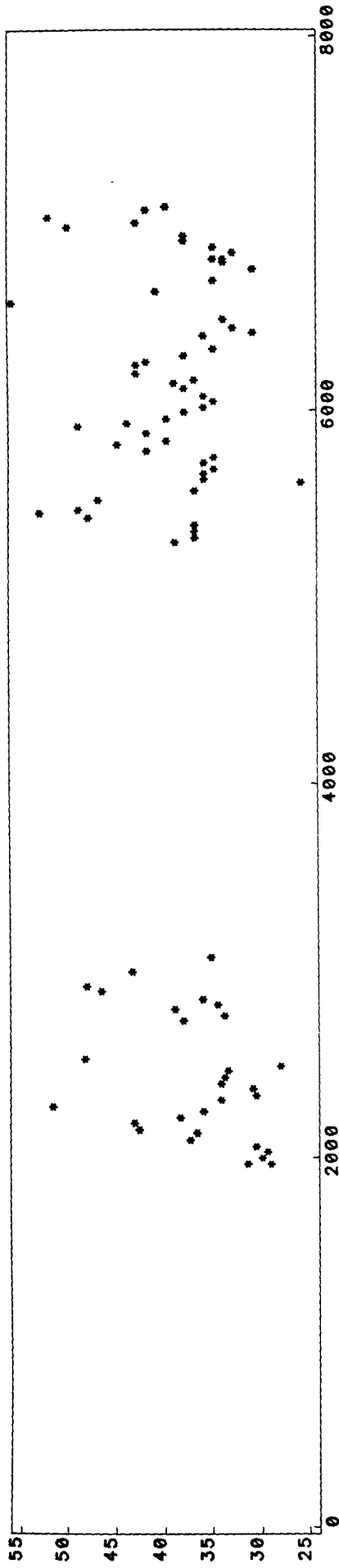

River no 14 conductivity

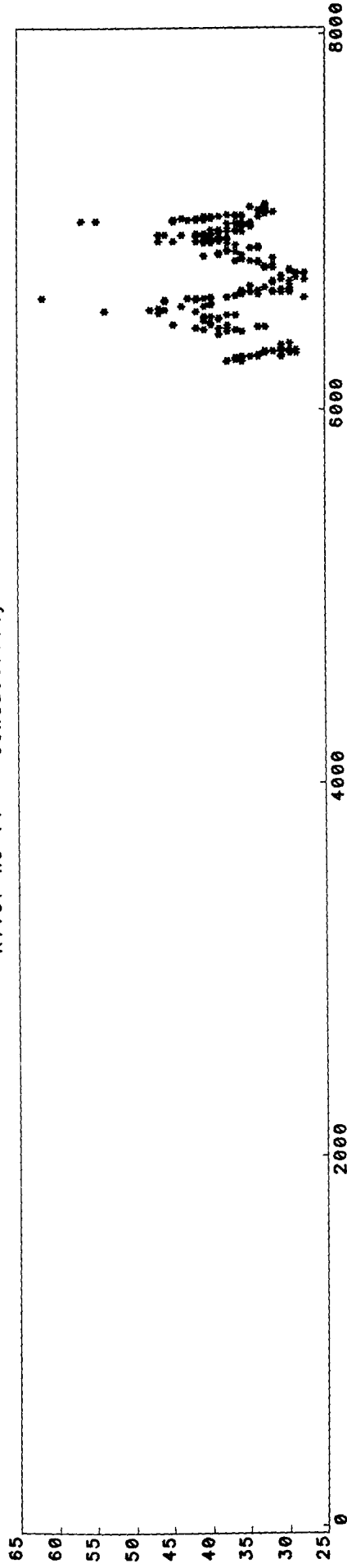

River no 15 conductivity

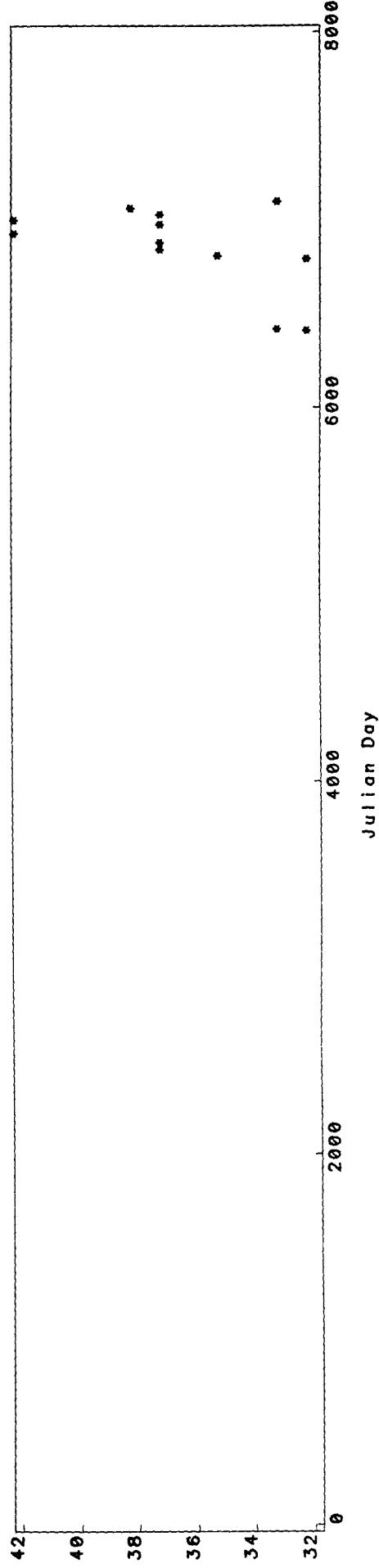

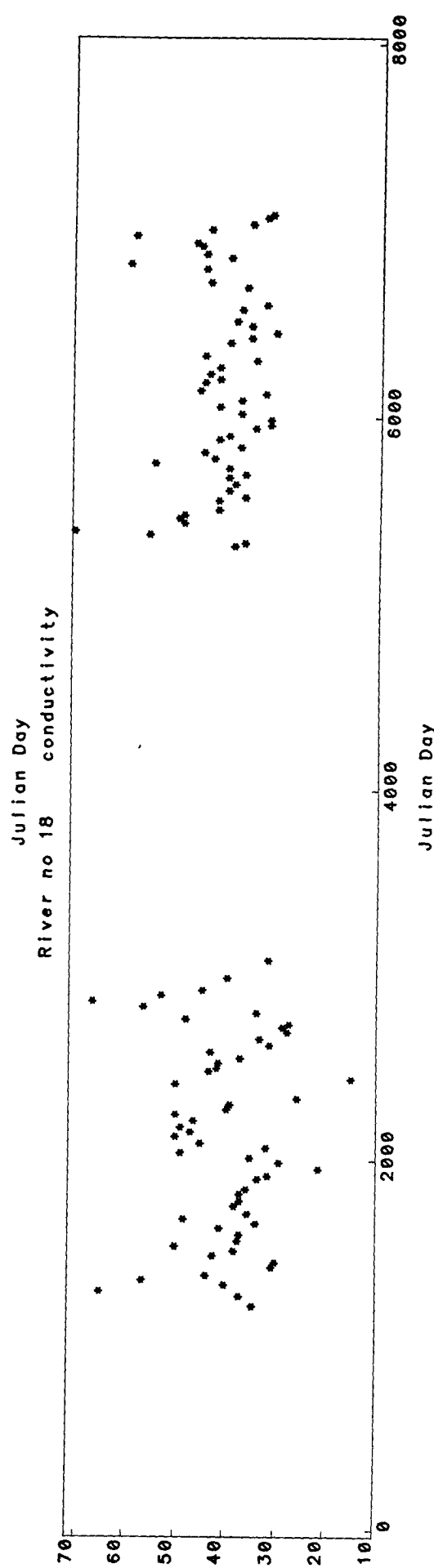
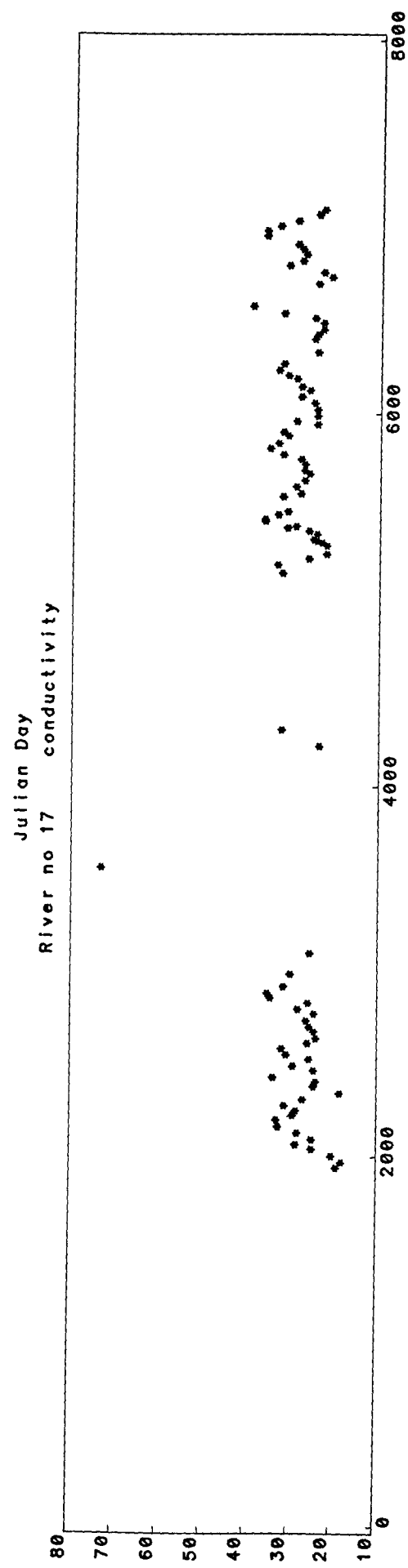
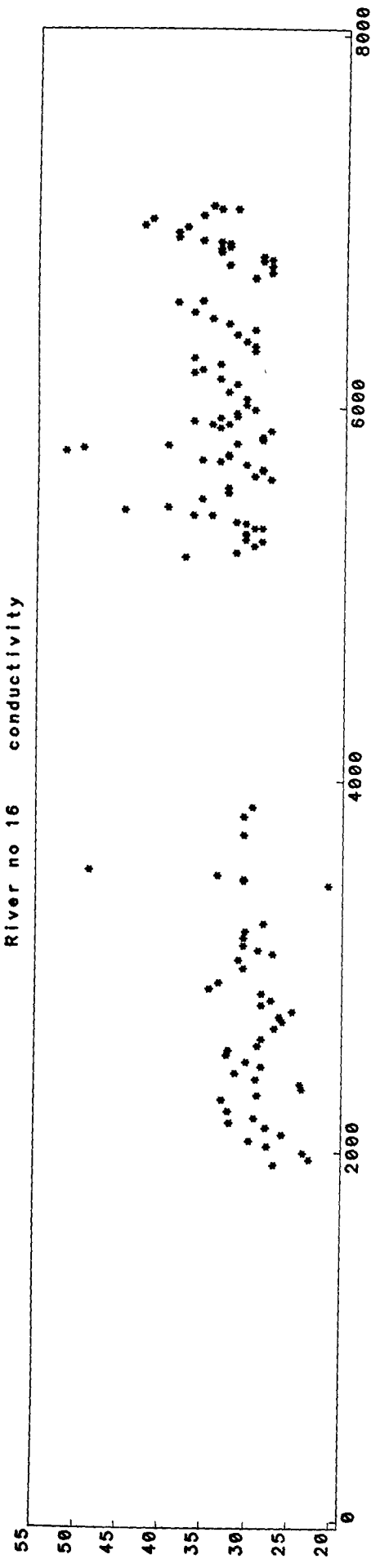

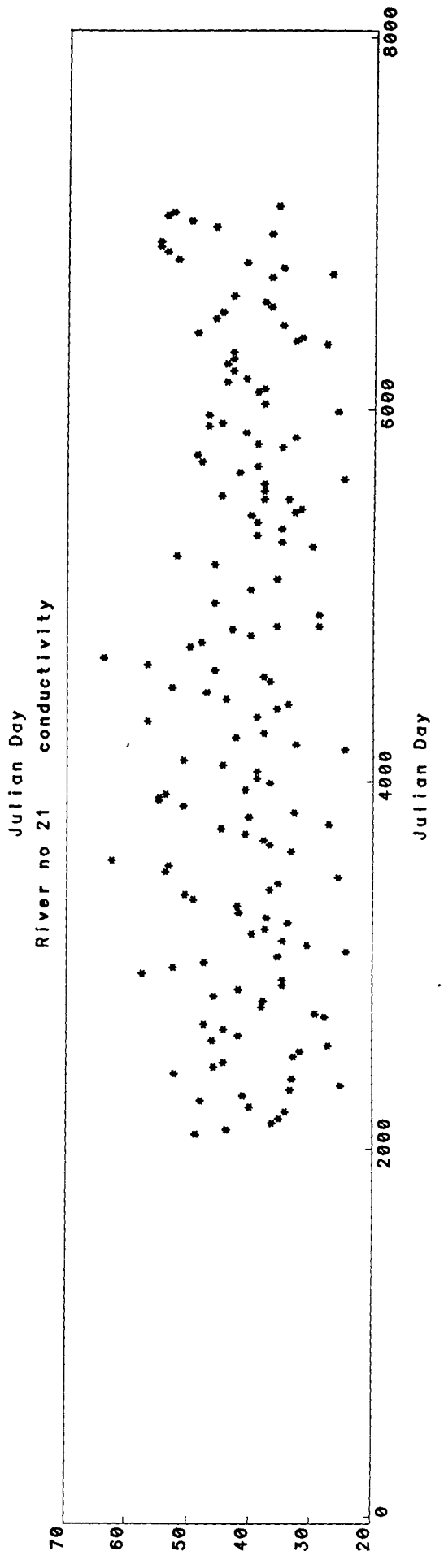
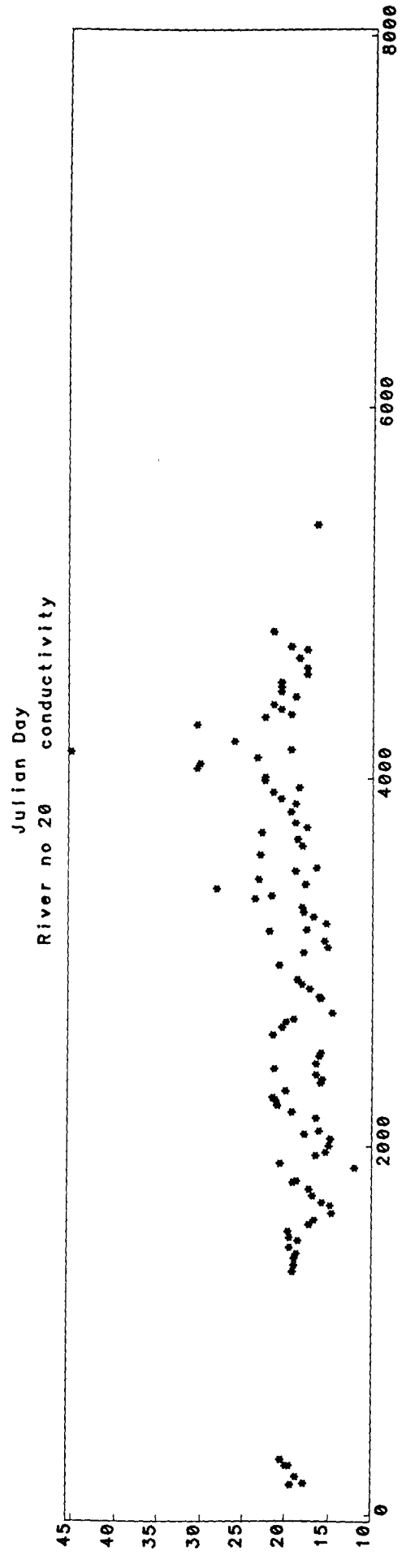
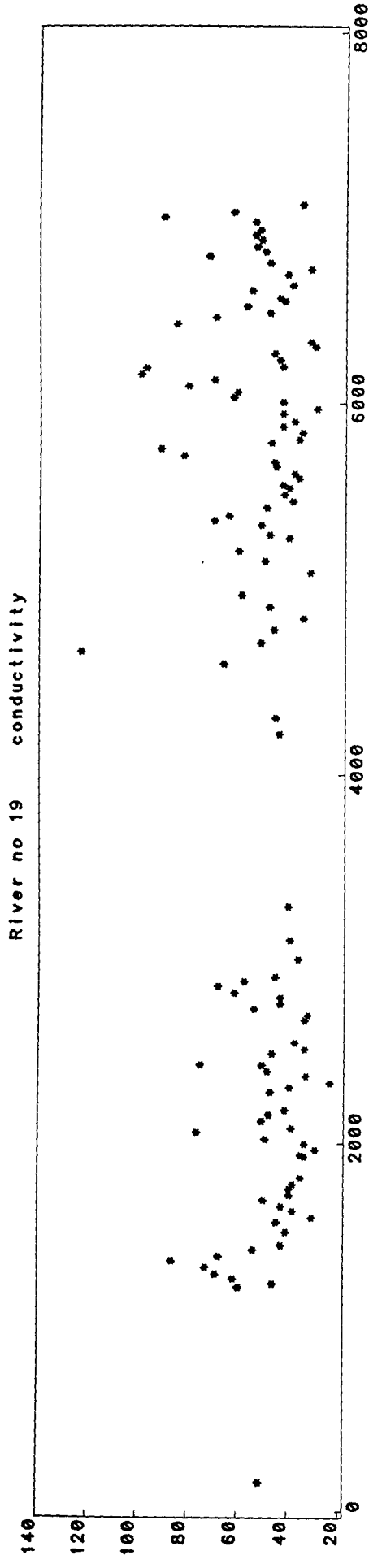

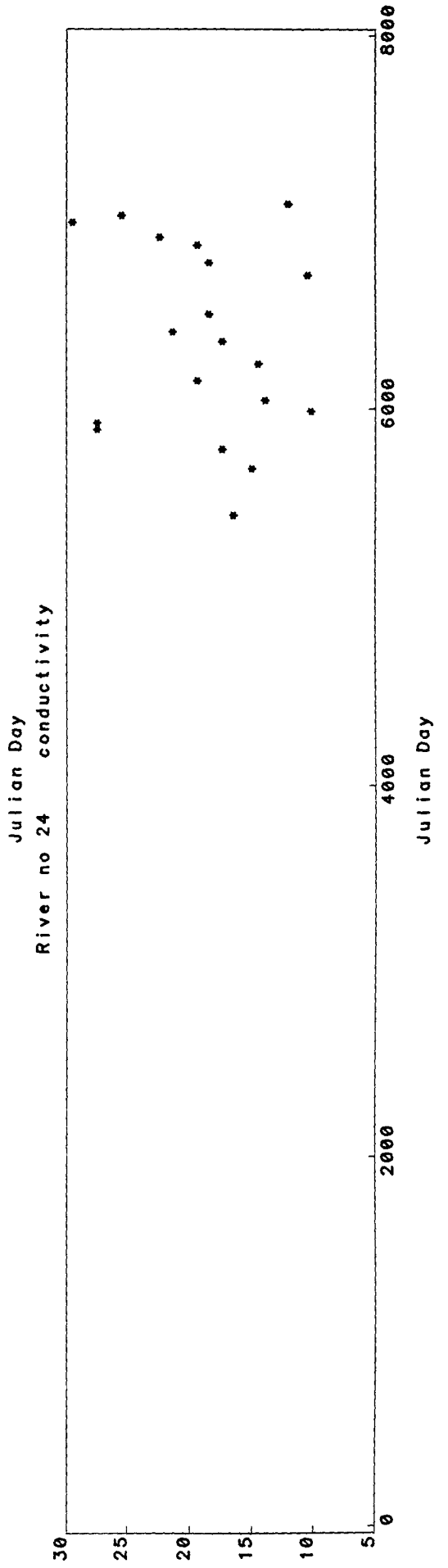
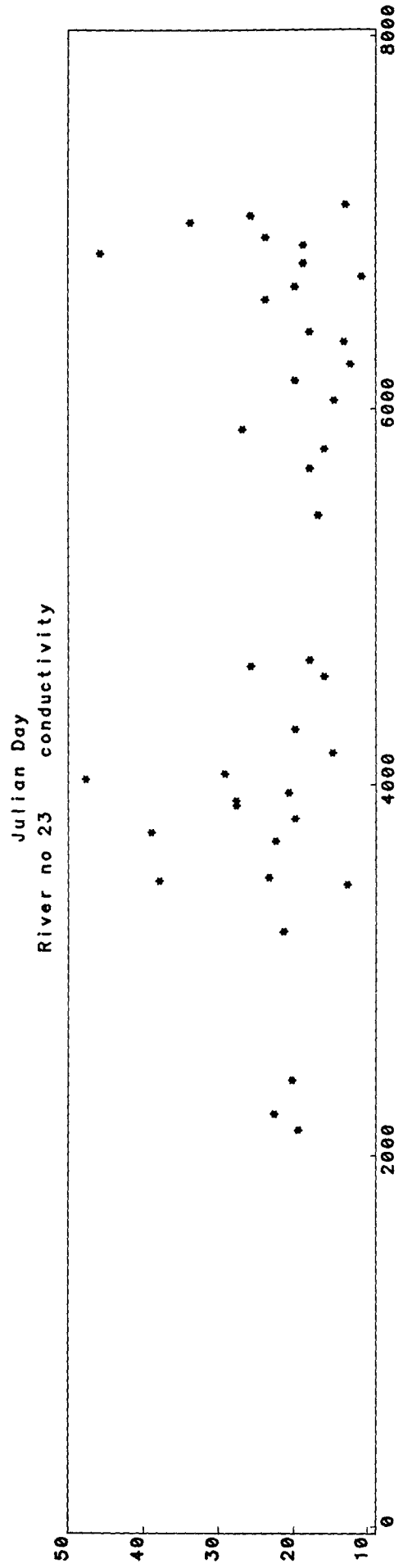
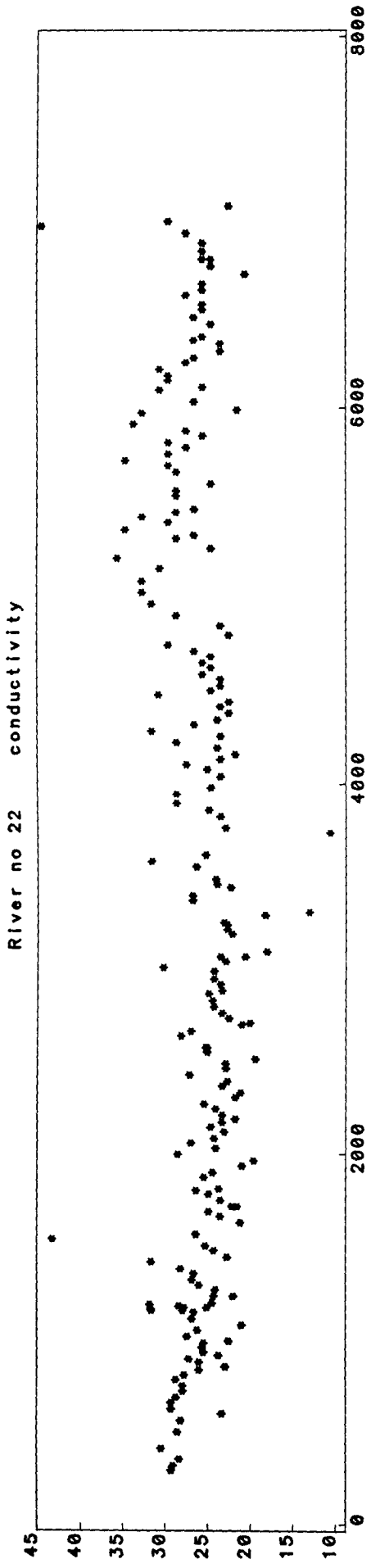

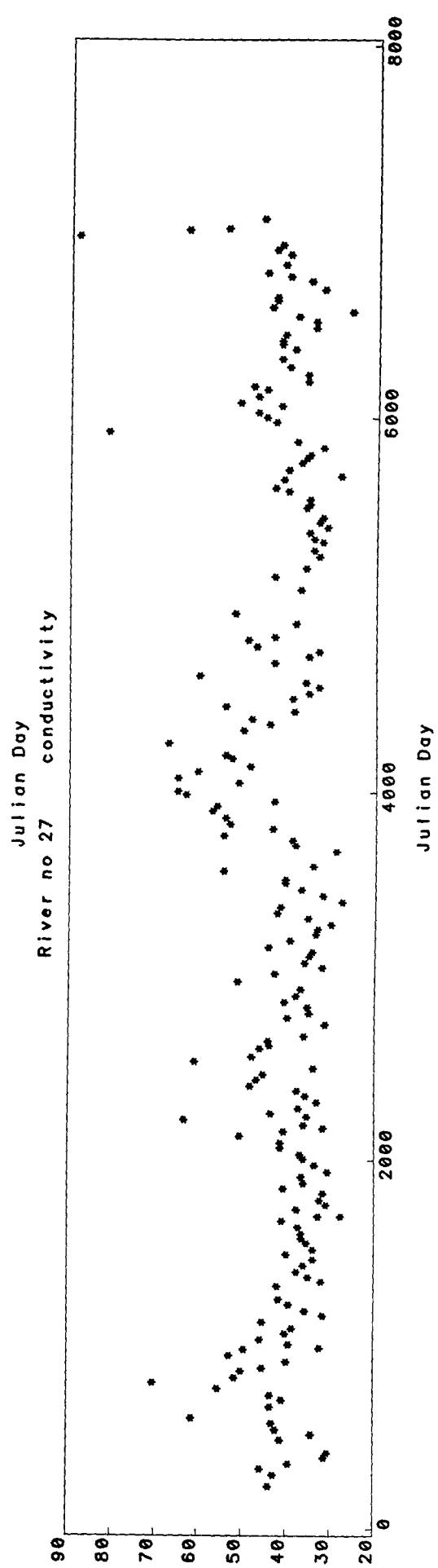
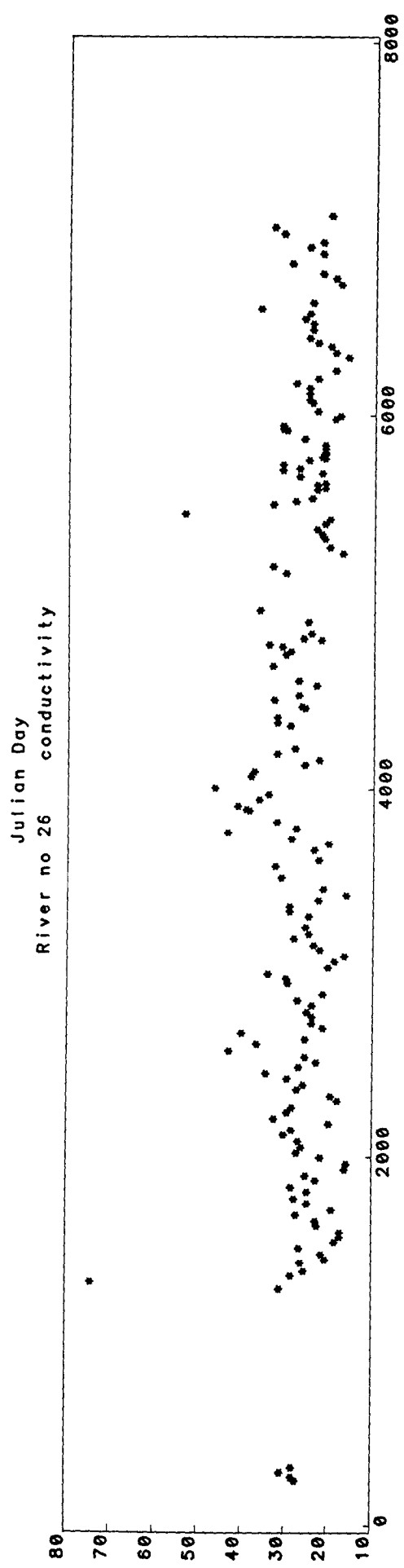
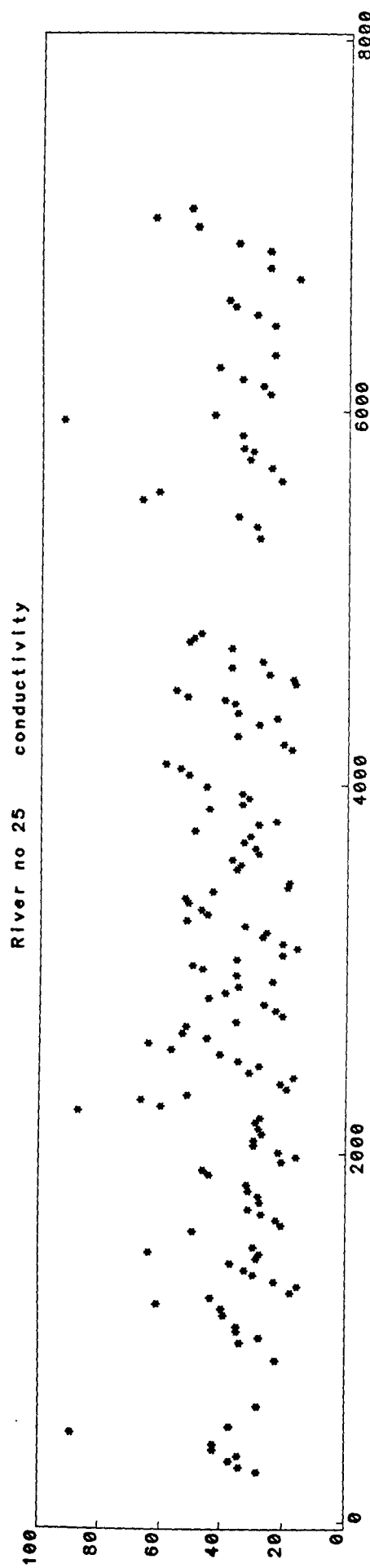

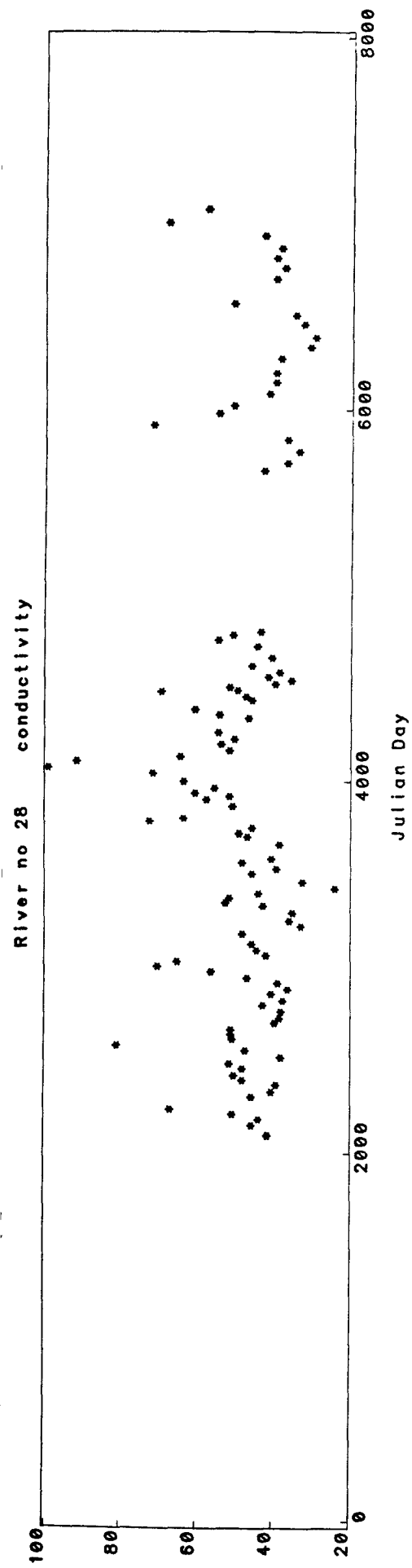

Appendix 7. Scatter plots of colour for the study rivers.

River no 1 colour

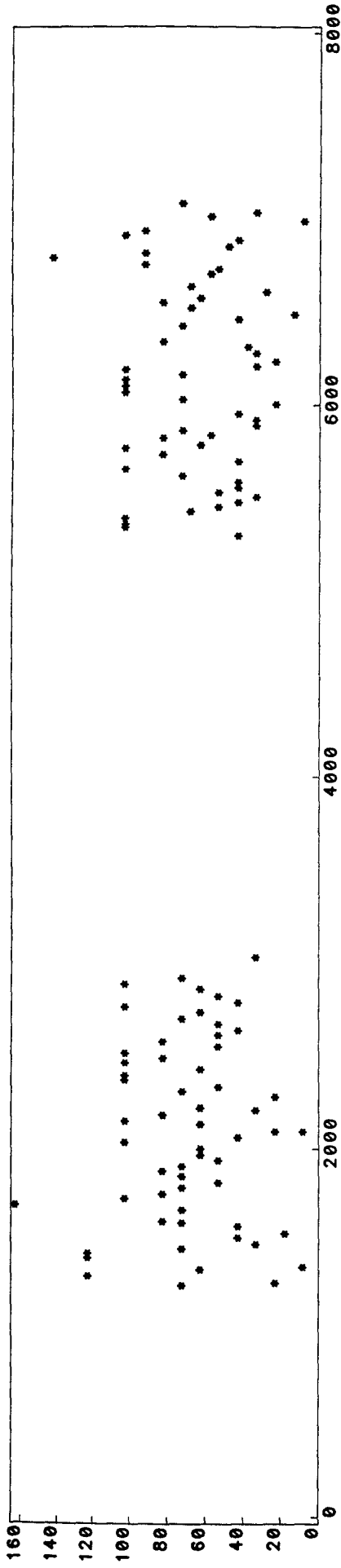

Julian Day  
River no 2 colour

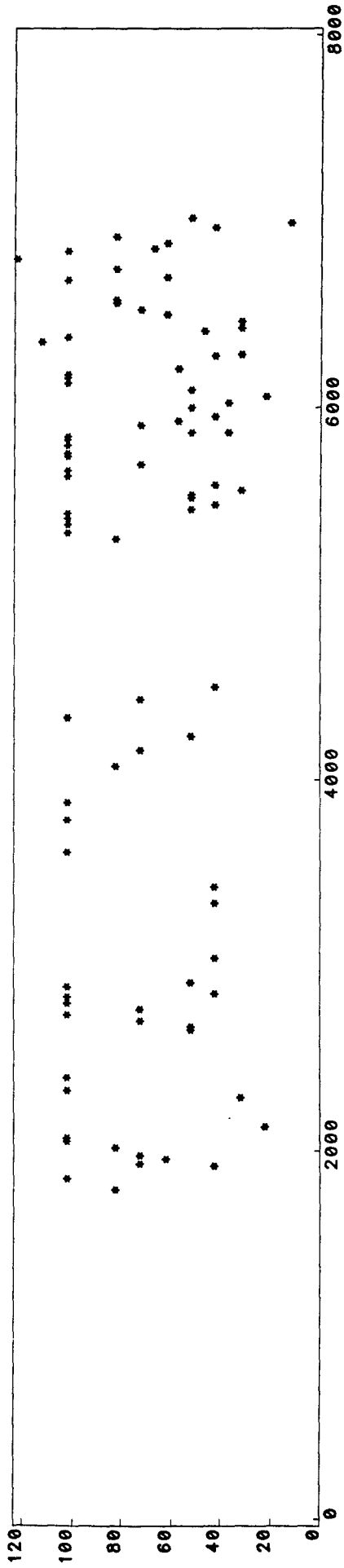

Julian Day  
River no 3 colour

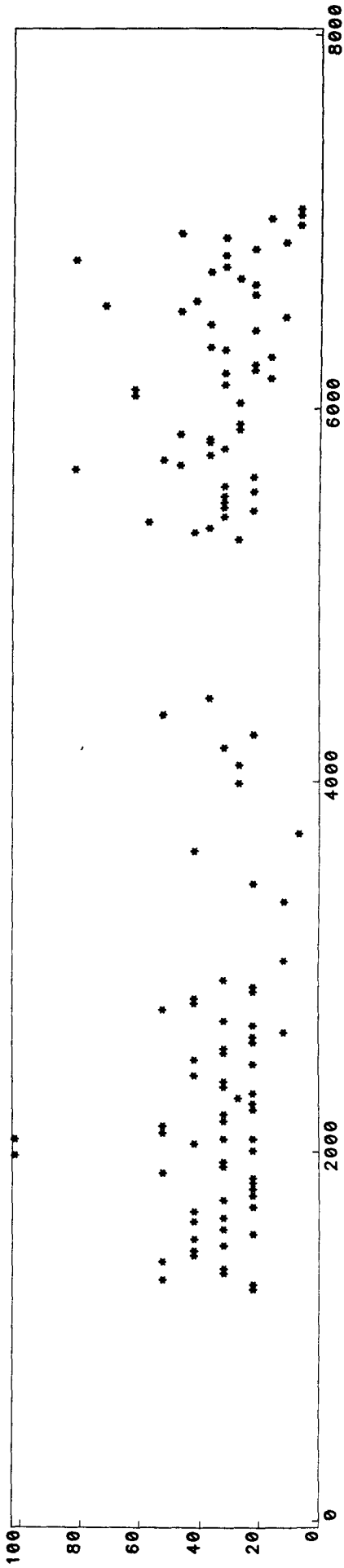



River no 4 colour

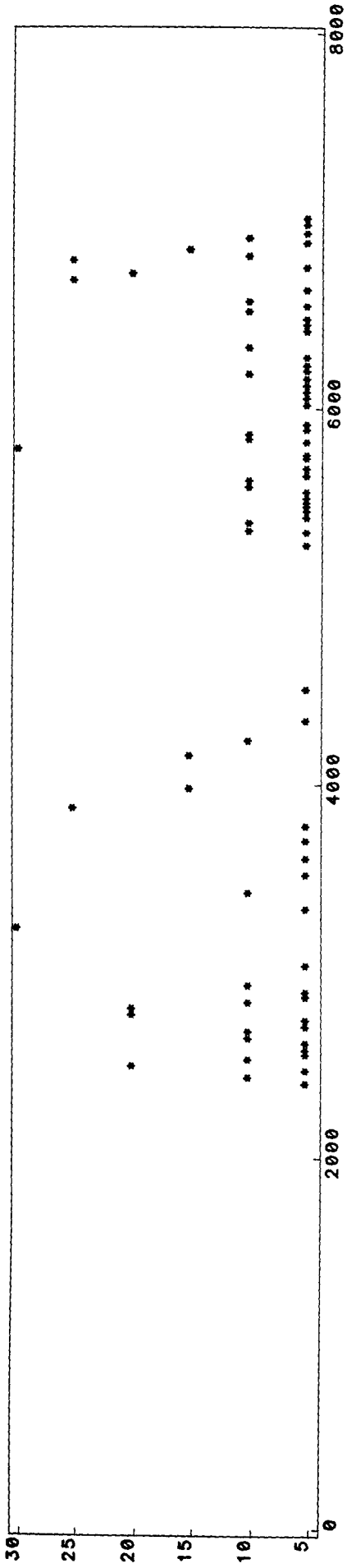

Julian Day  
River no 5 colour

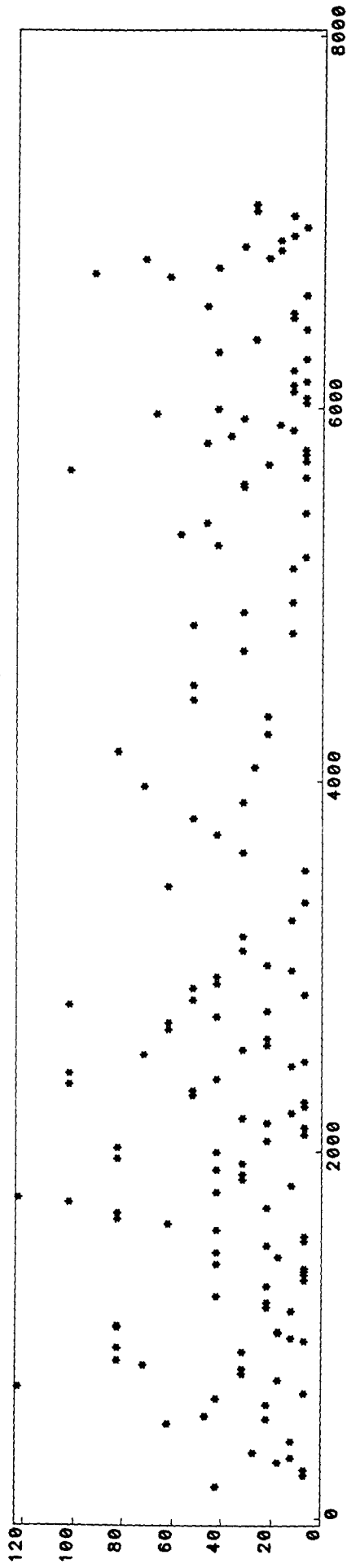

Julian Day  
River no 6 colour

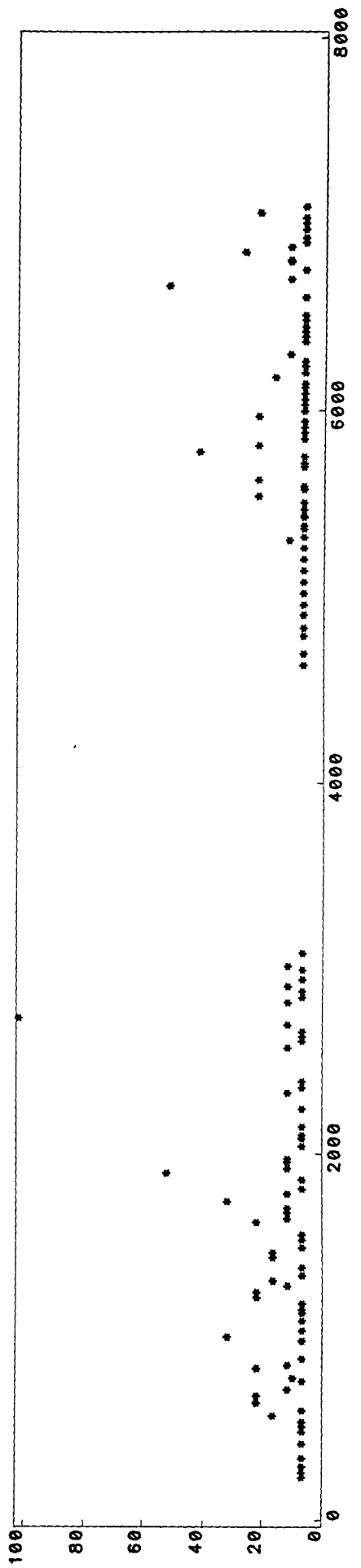

River no 7 colour

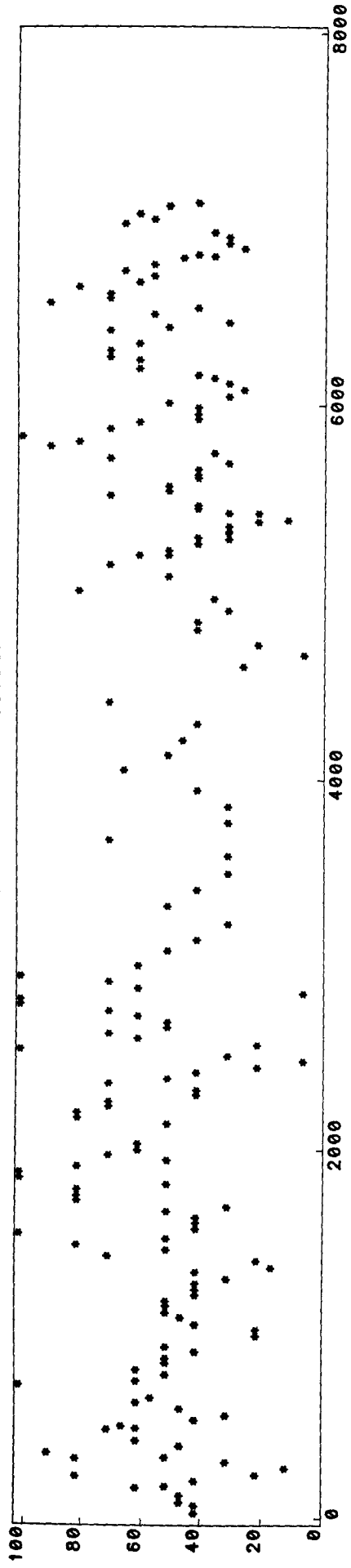

River no 8 colour

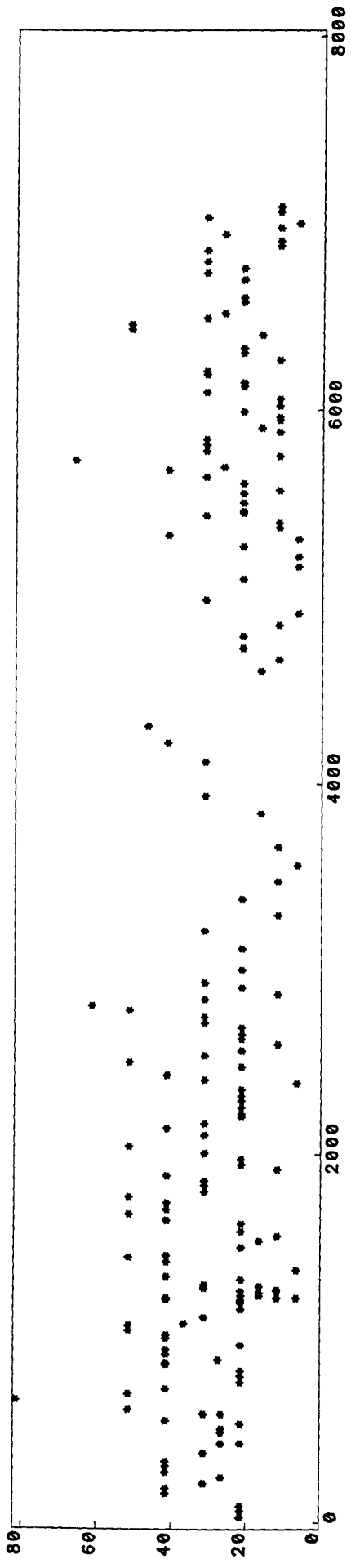

River no 9 colour

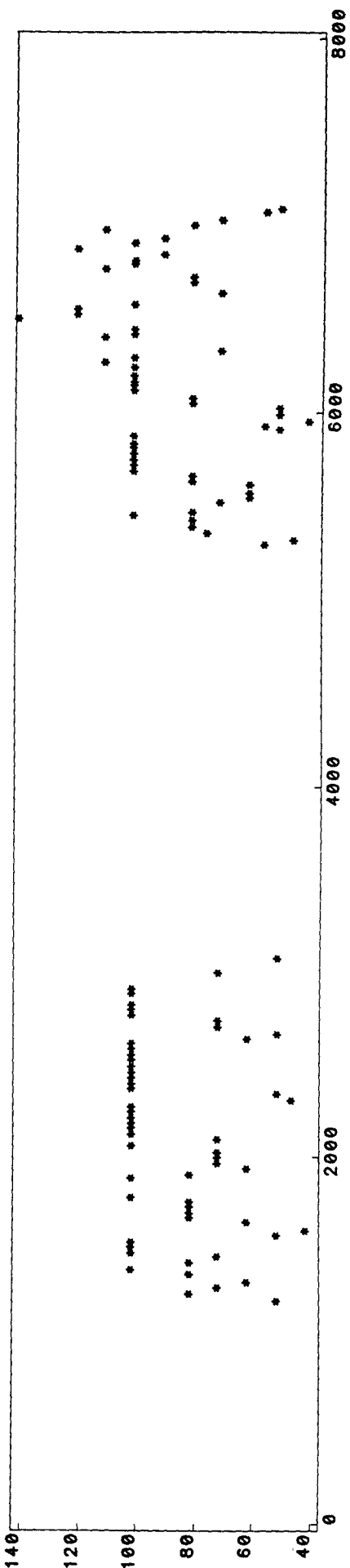

River no 10 colour

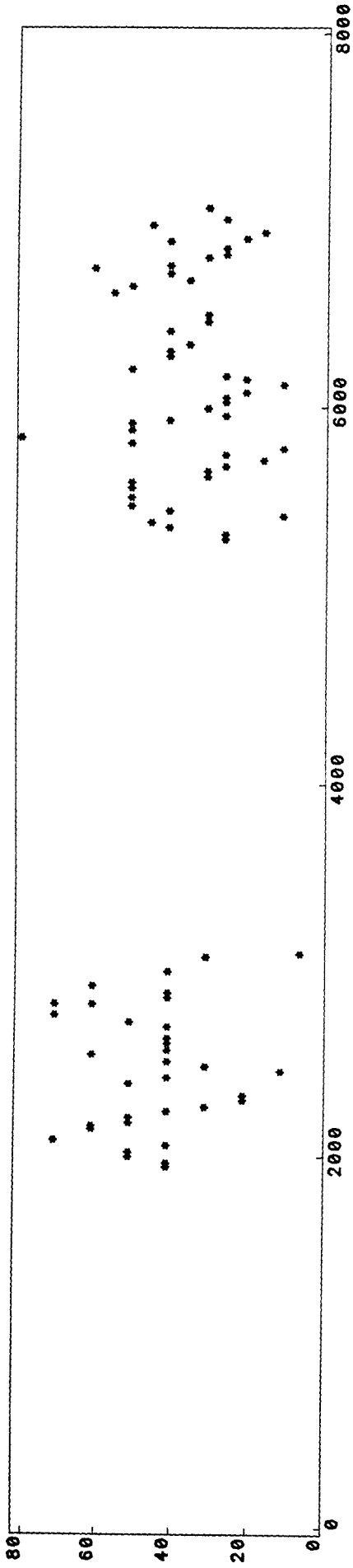

River no 11 colour

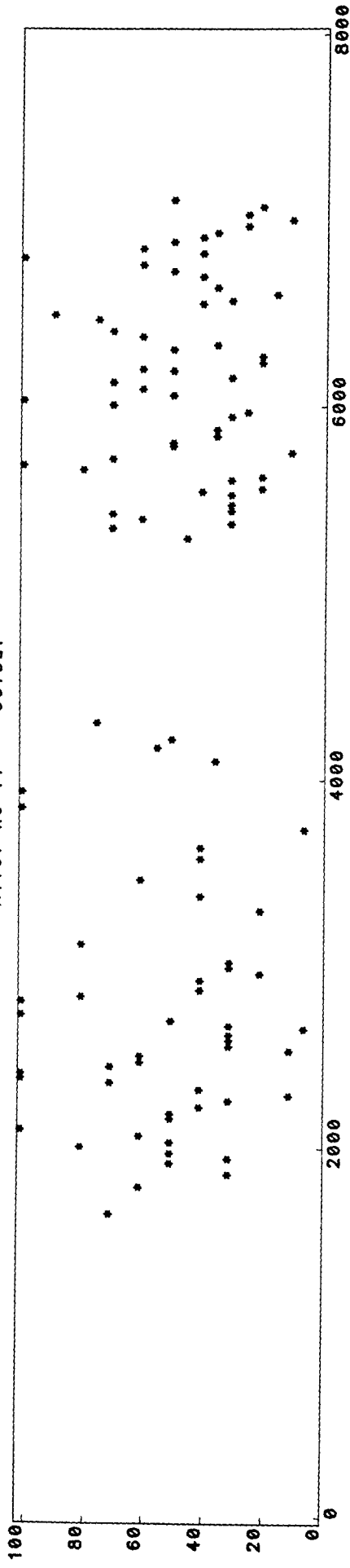

River no 12 colour

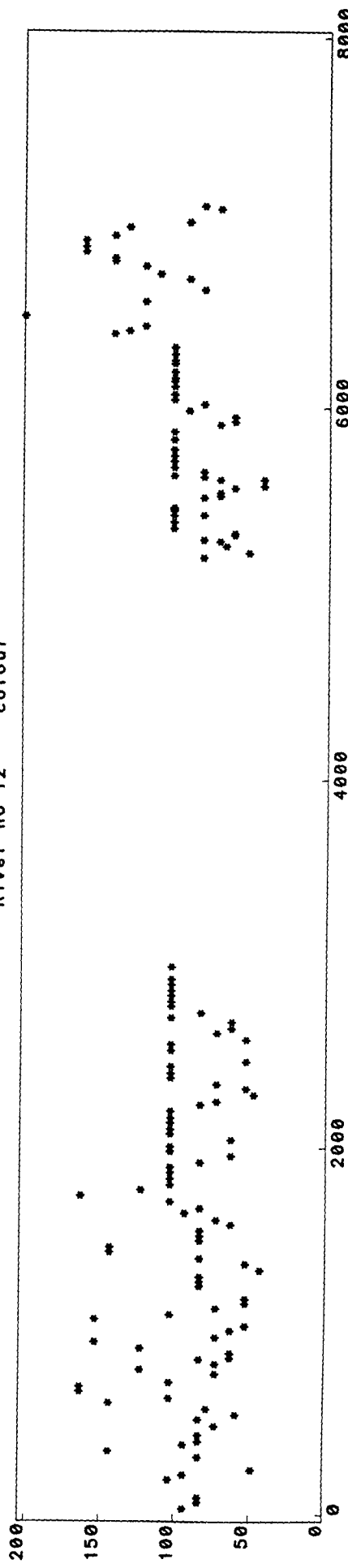

River no 13 colour

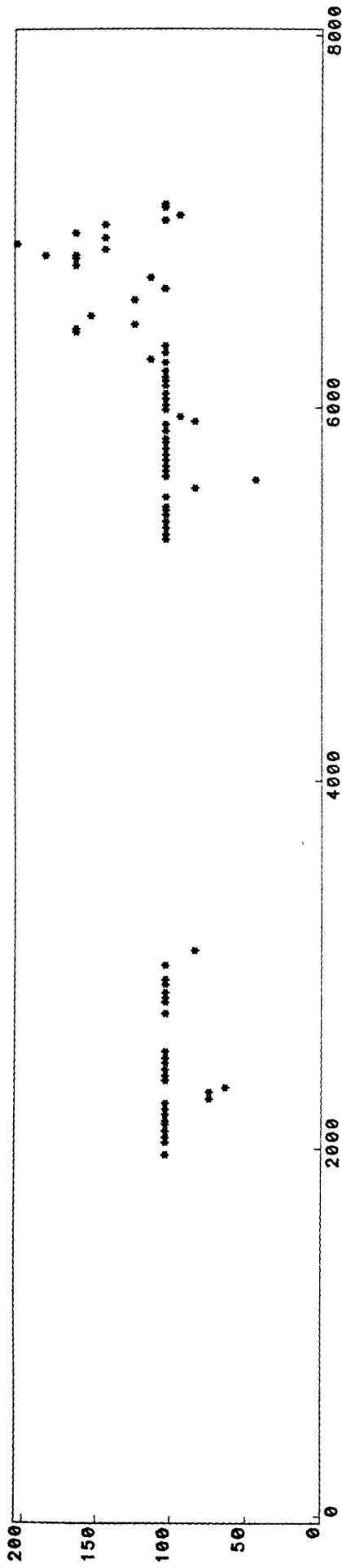

River no 14 colour

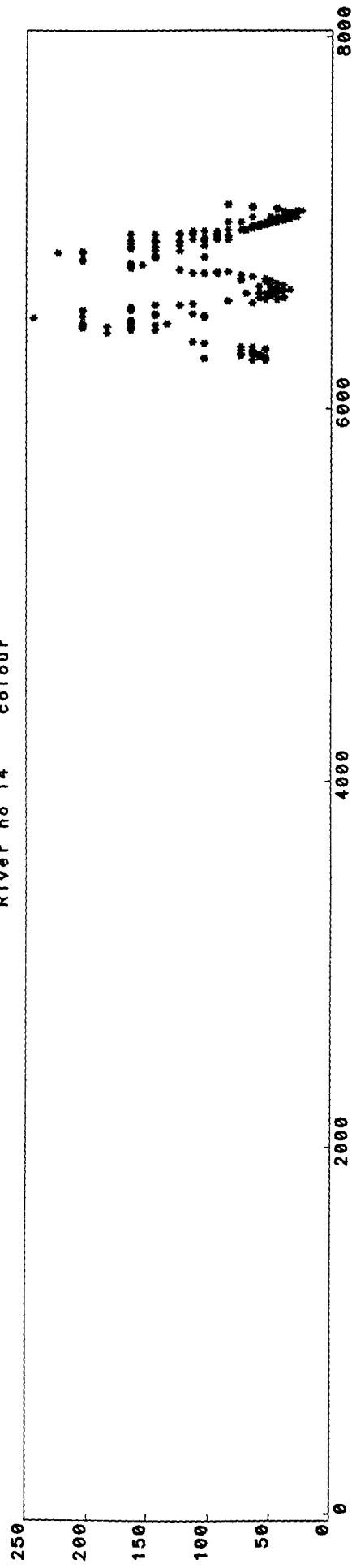

River no 15 colour

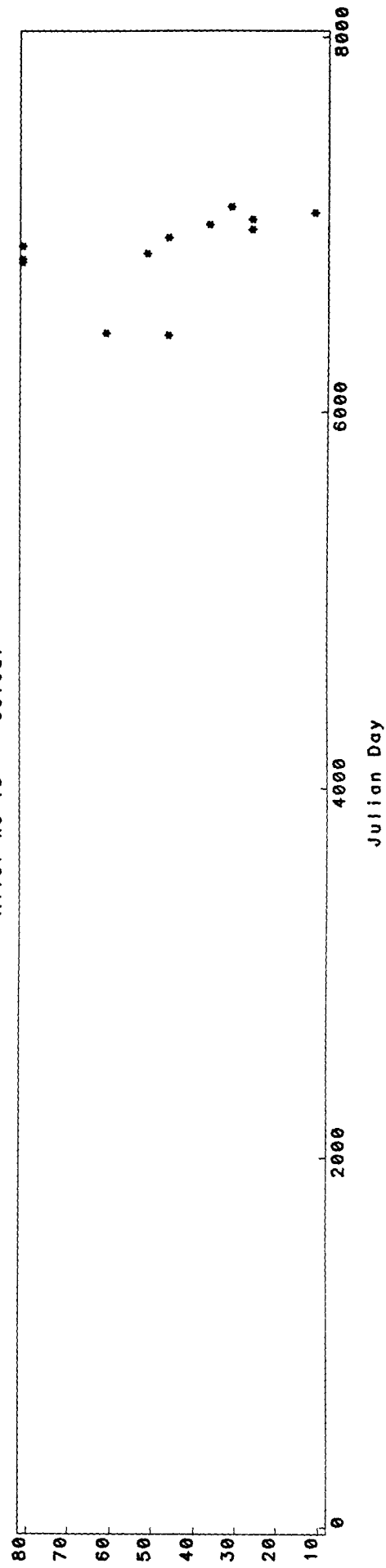

River no 16 colour

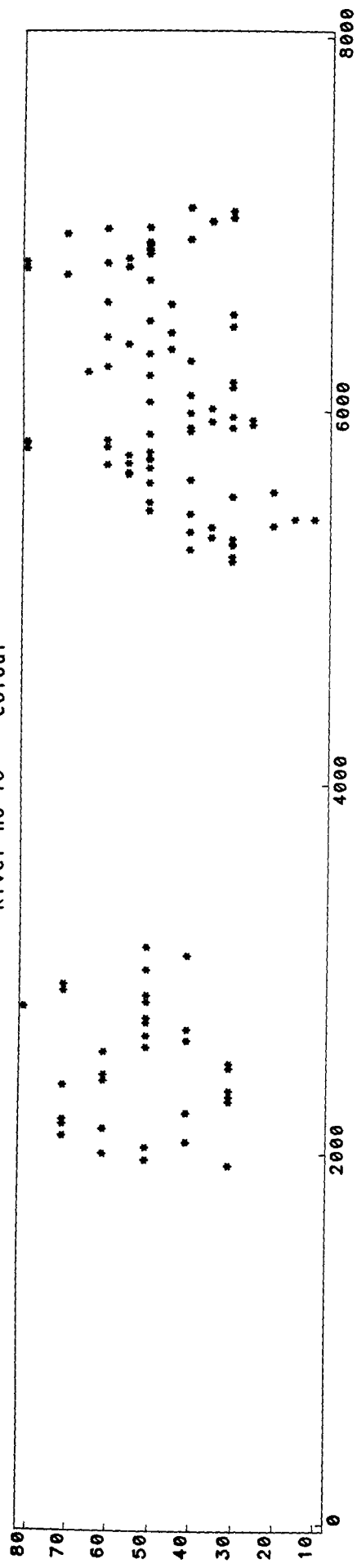

River no 17 colour

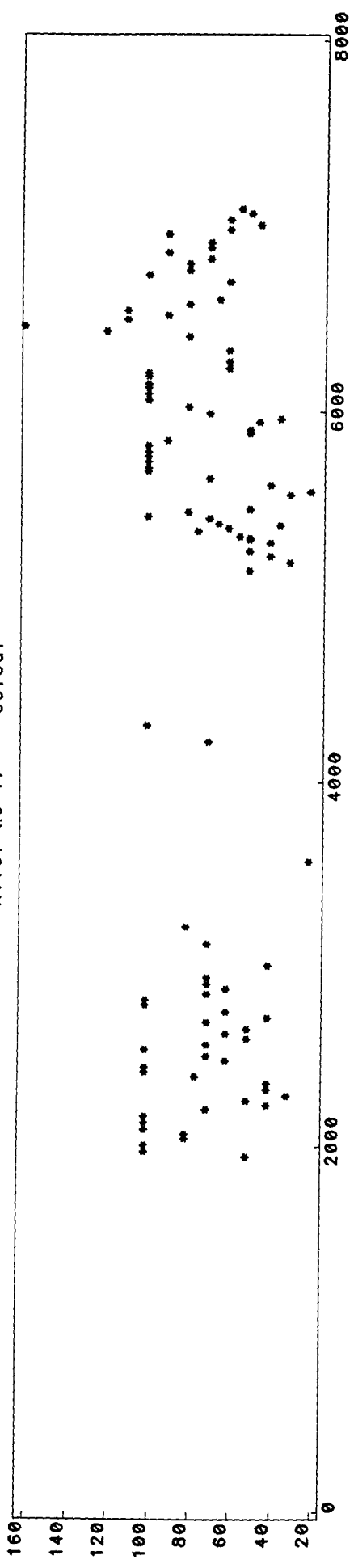

River no 18 colour

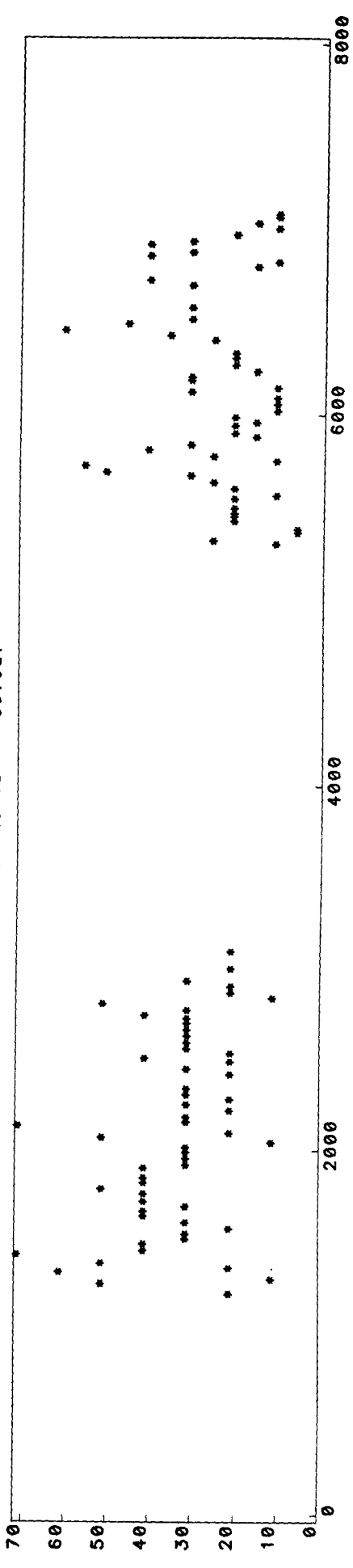

River no 19 colour

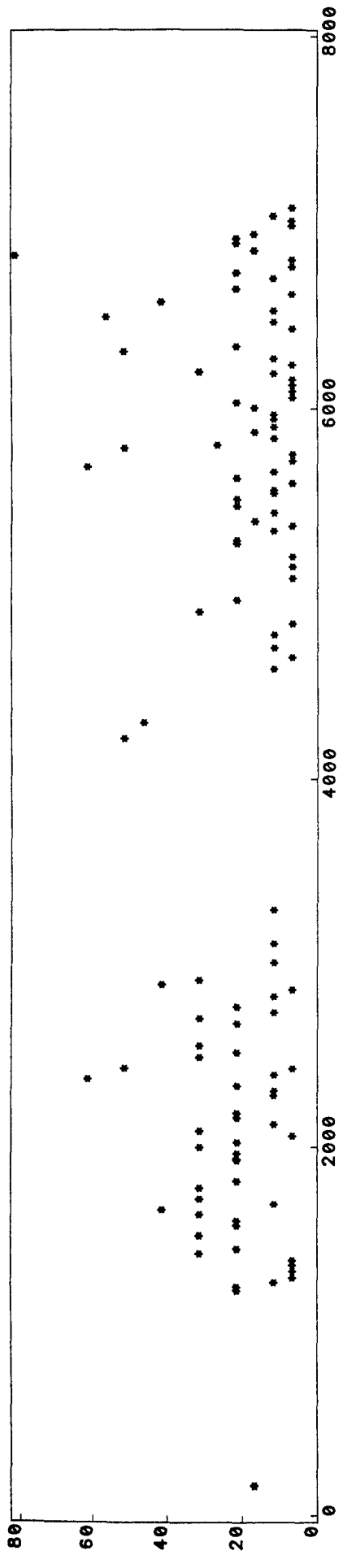

River no 20 colour

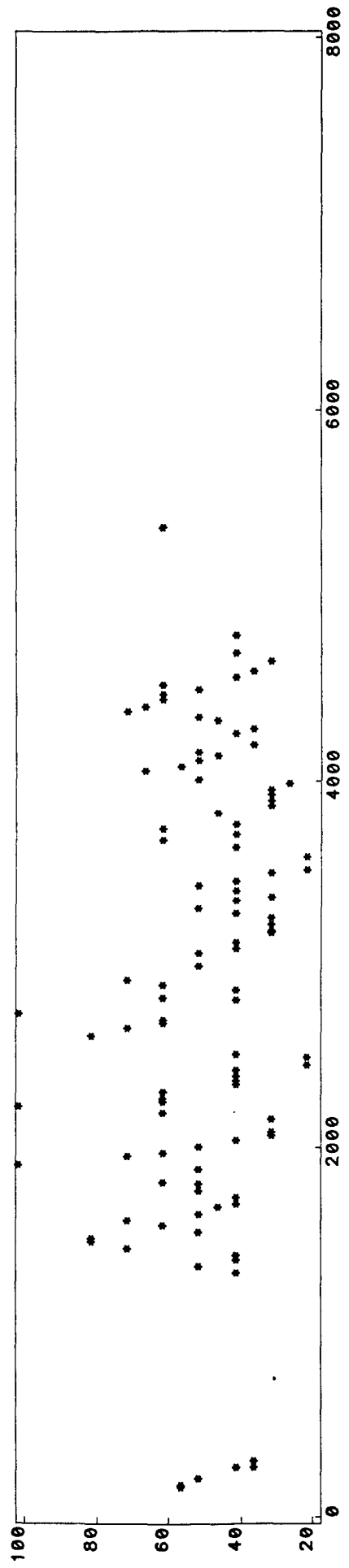

River no 21 colour

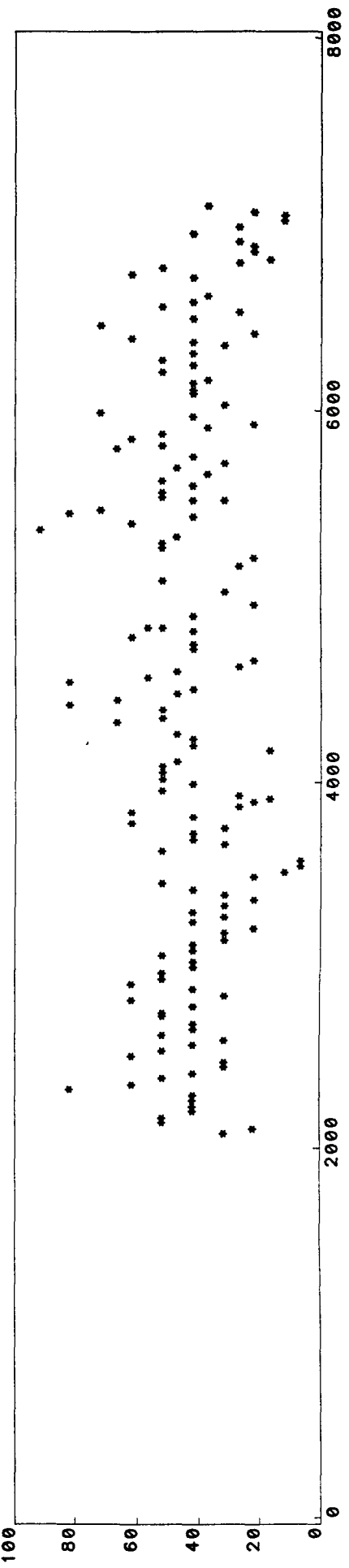

River no 22 colour

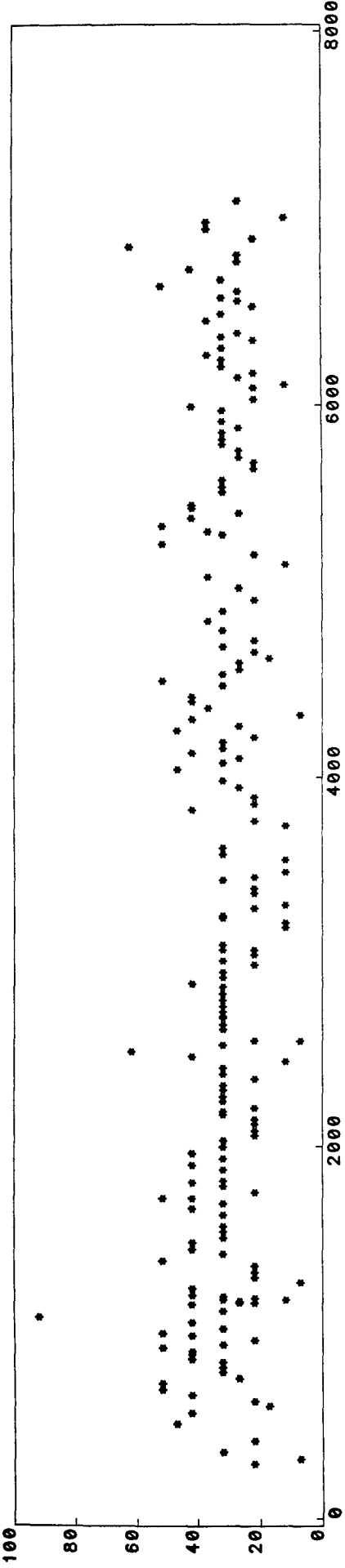

Julian Day  
River no 23 colour

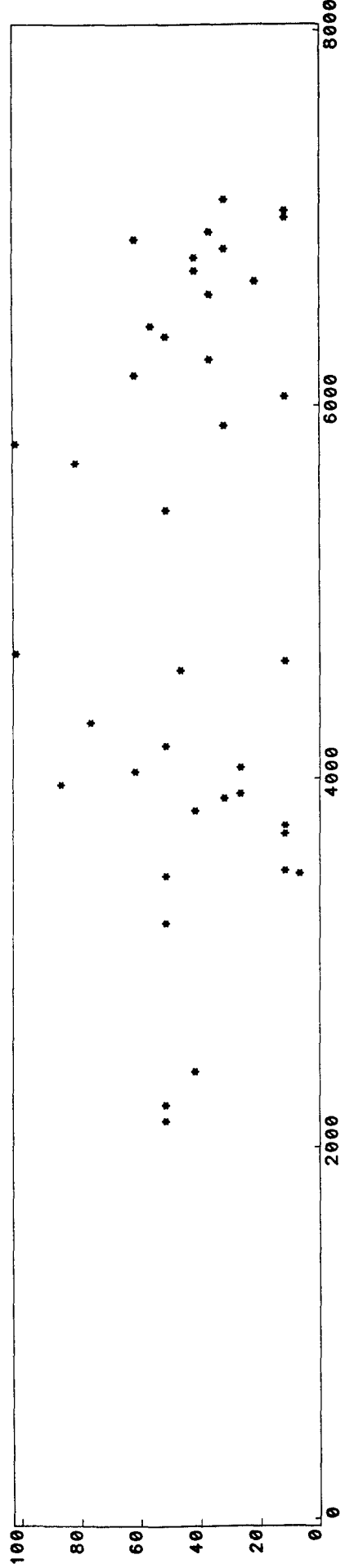

Julian Day  
River no 24 colour

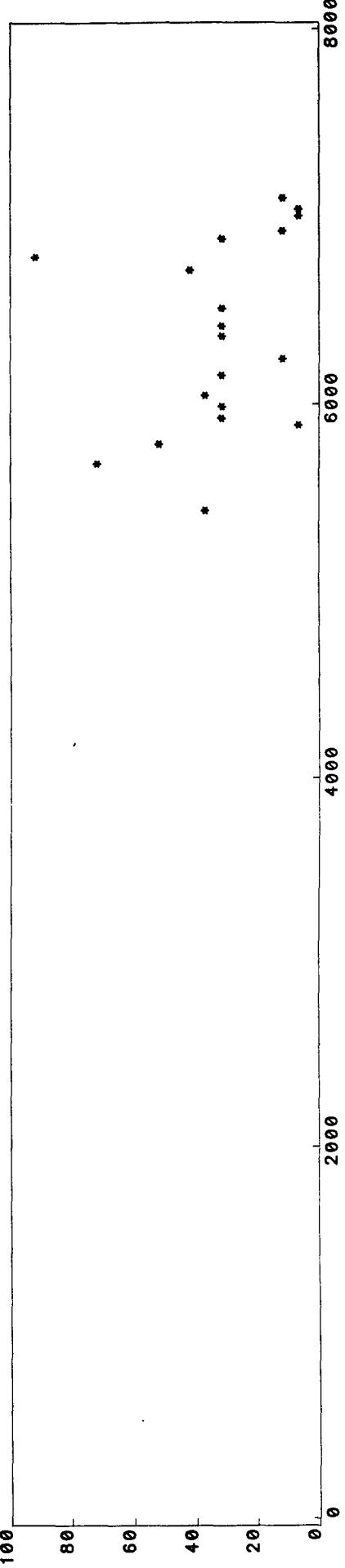

River no 25 colour

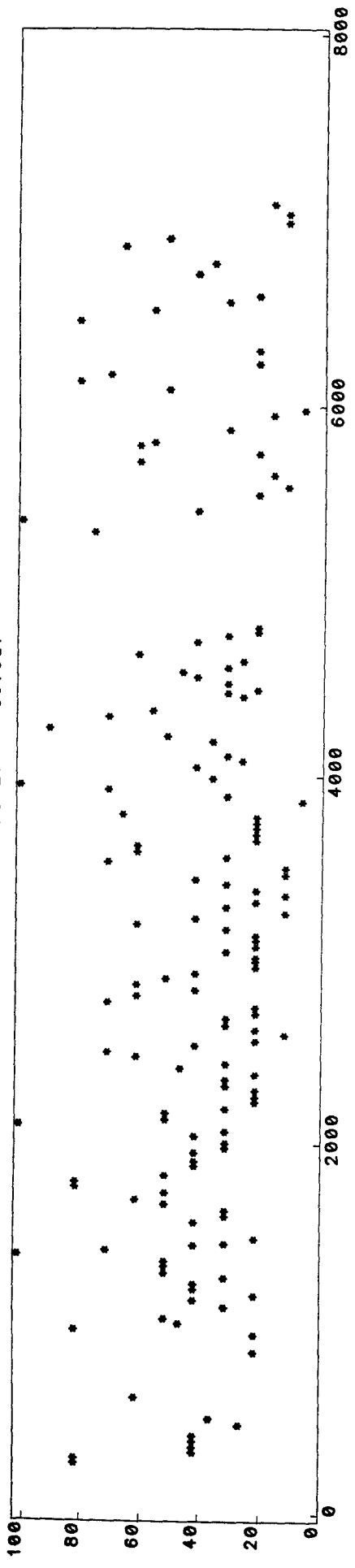

River no 26 colour

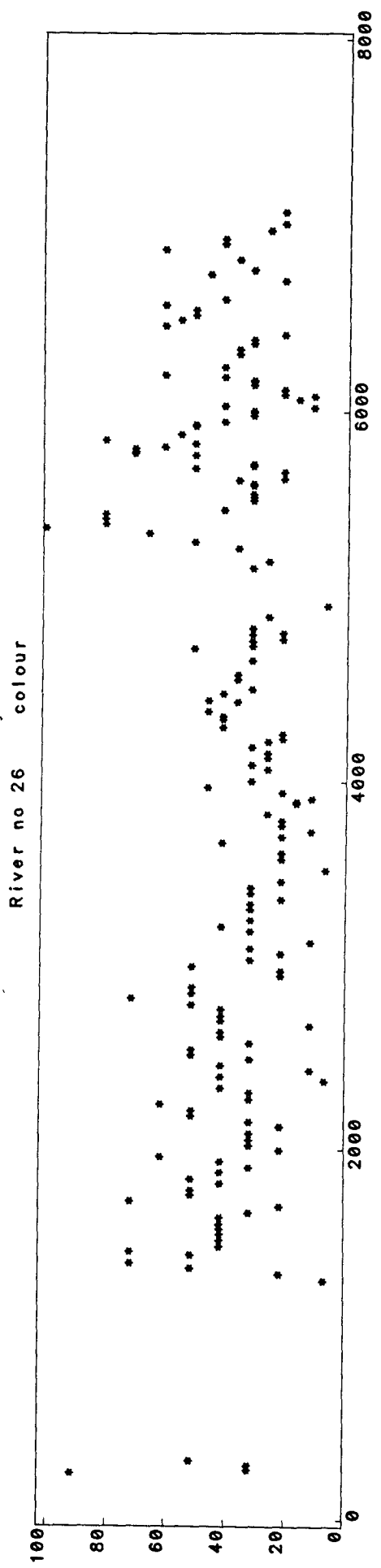

River no 27 colour

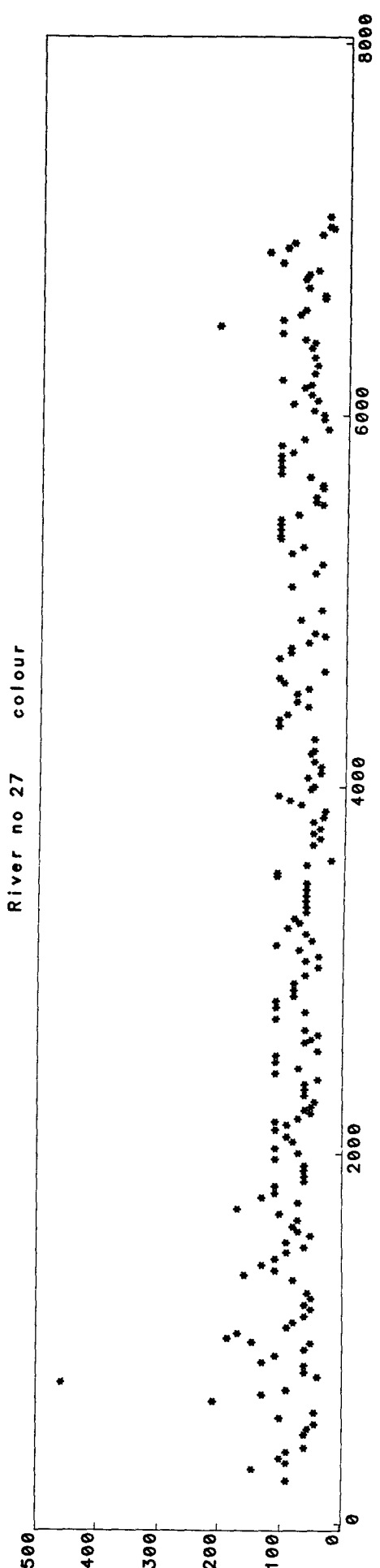



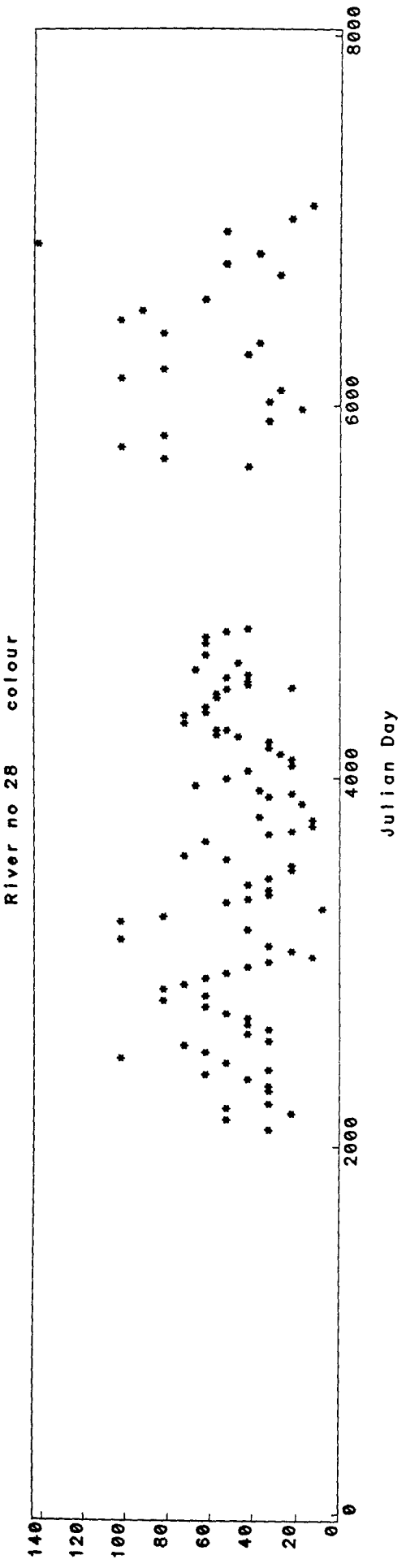

Appendix 8. Scatter plots of turbidity for the study rivers.

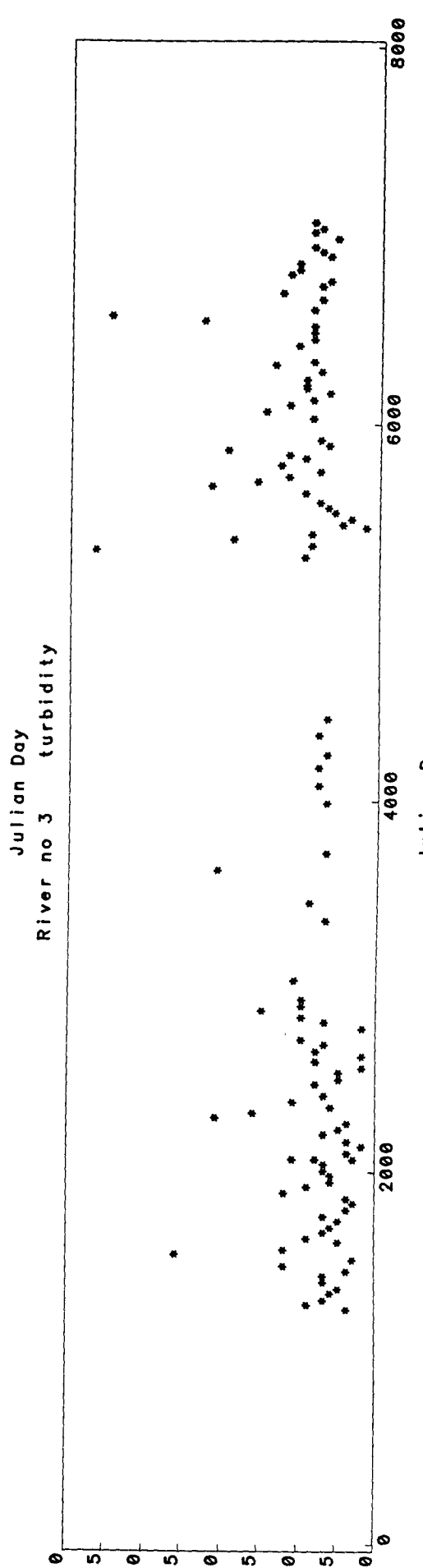
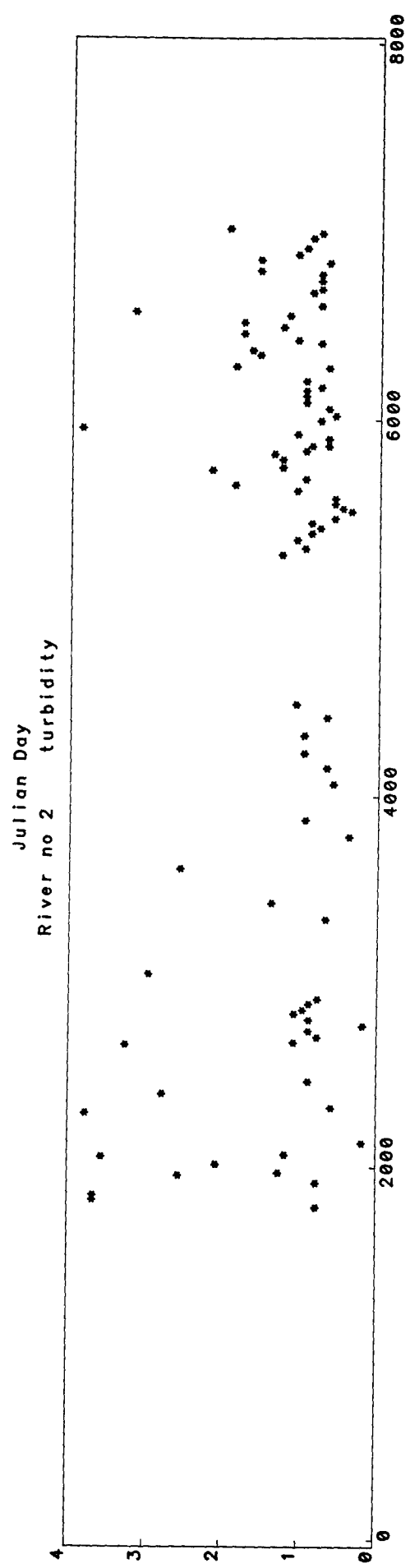
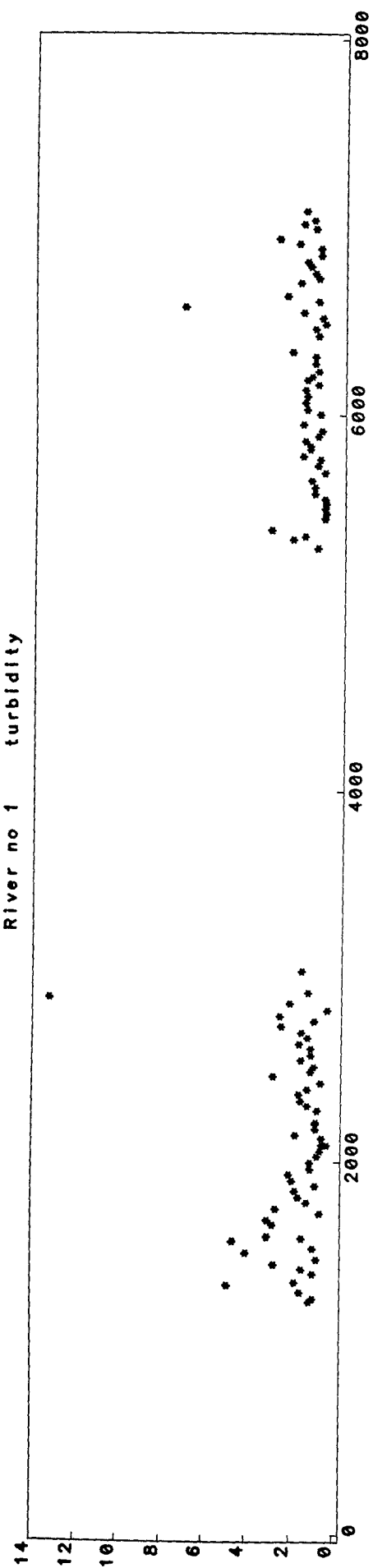

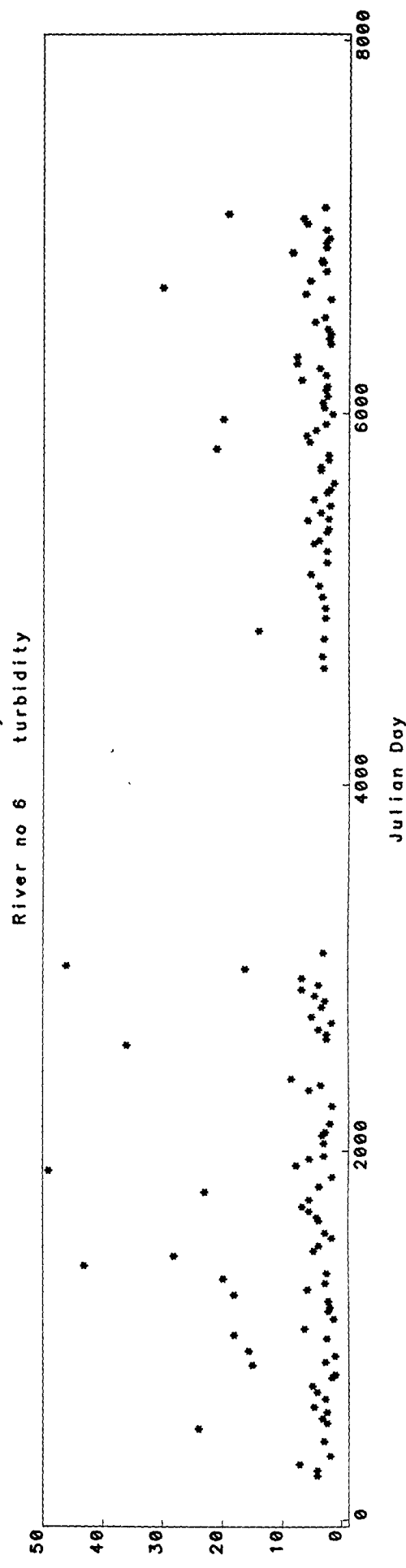
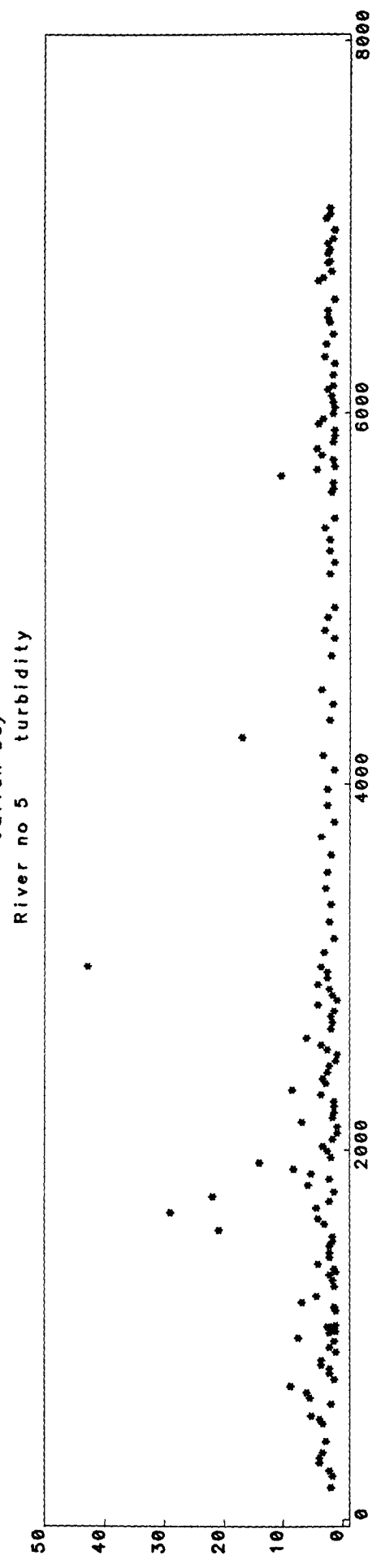
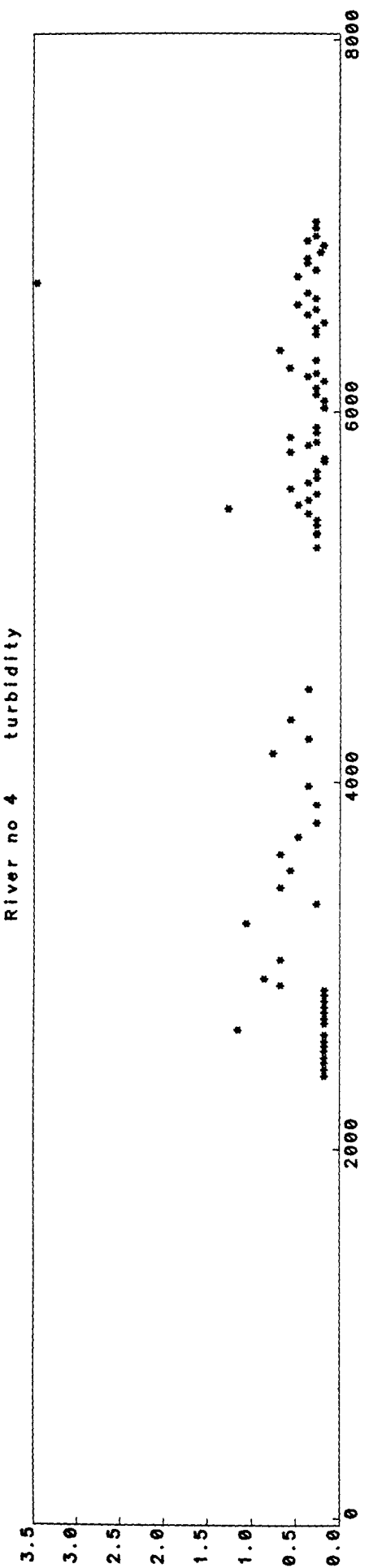

River no 7 turbidity

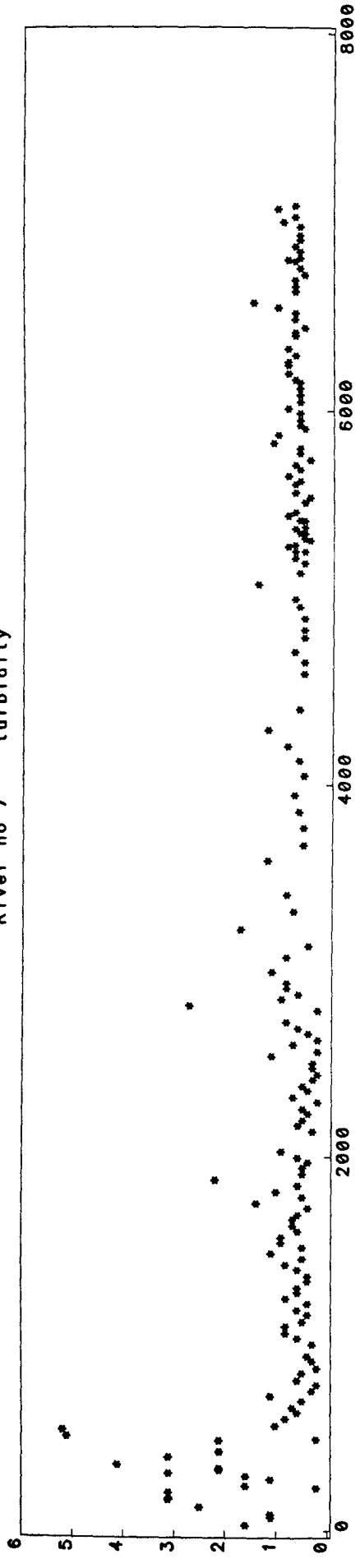

River no 8 turbidity

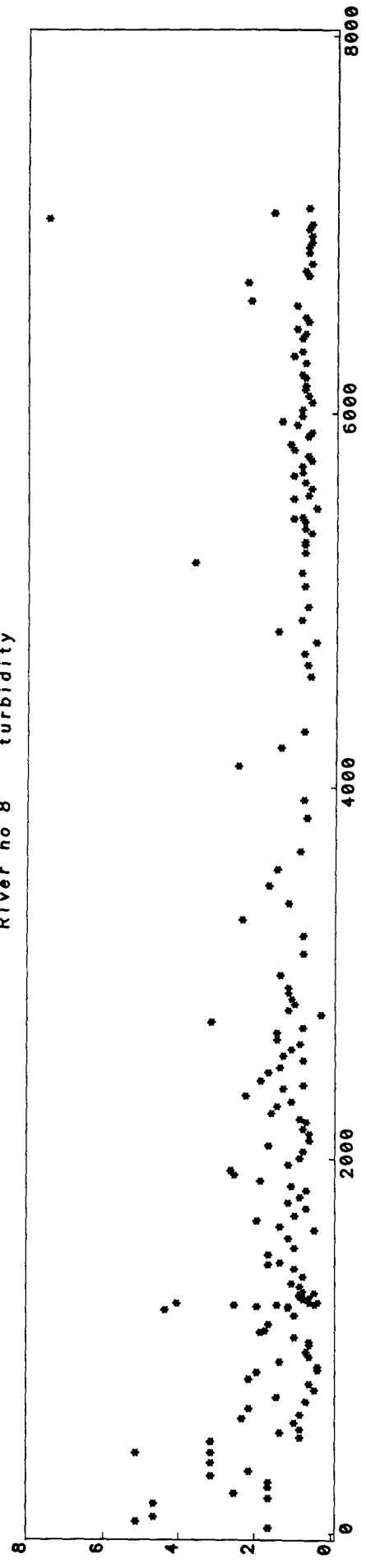

River no 9 turbidity

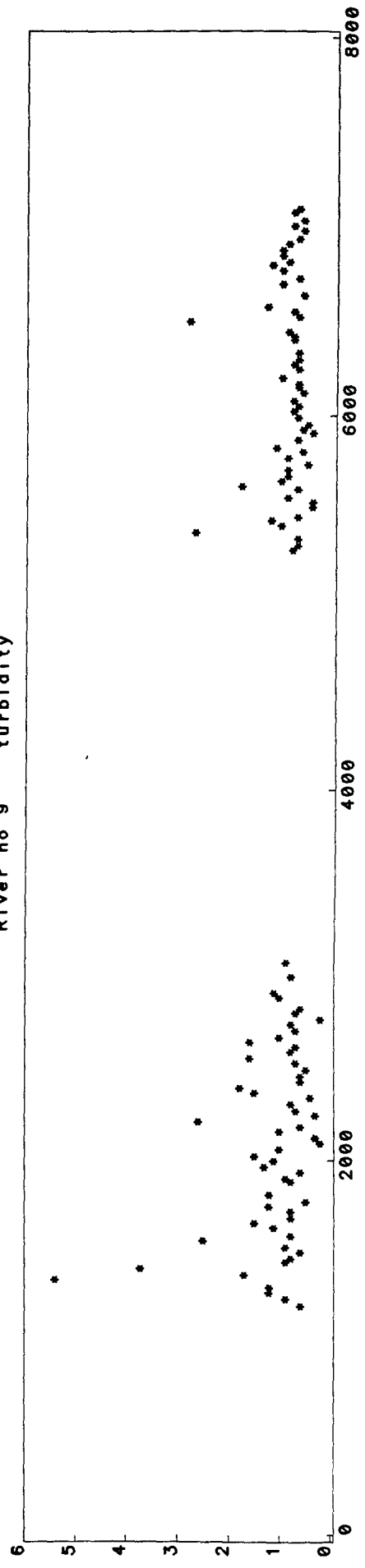

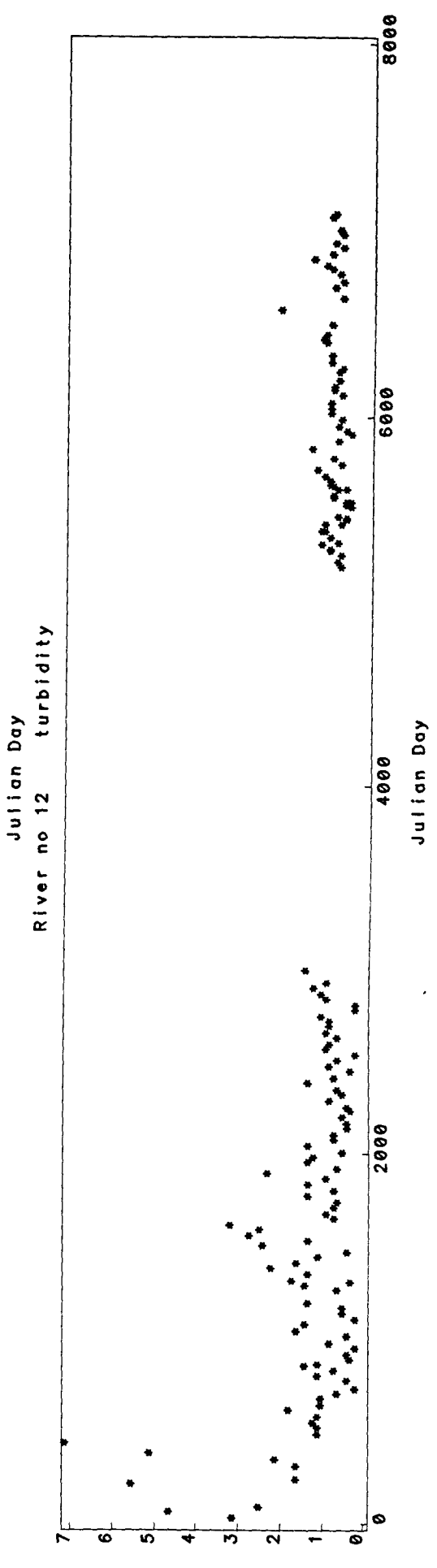
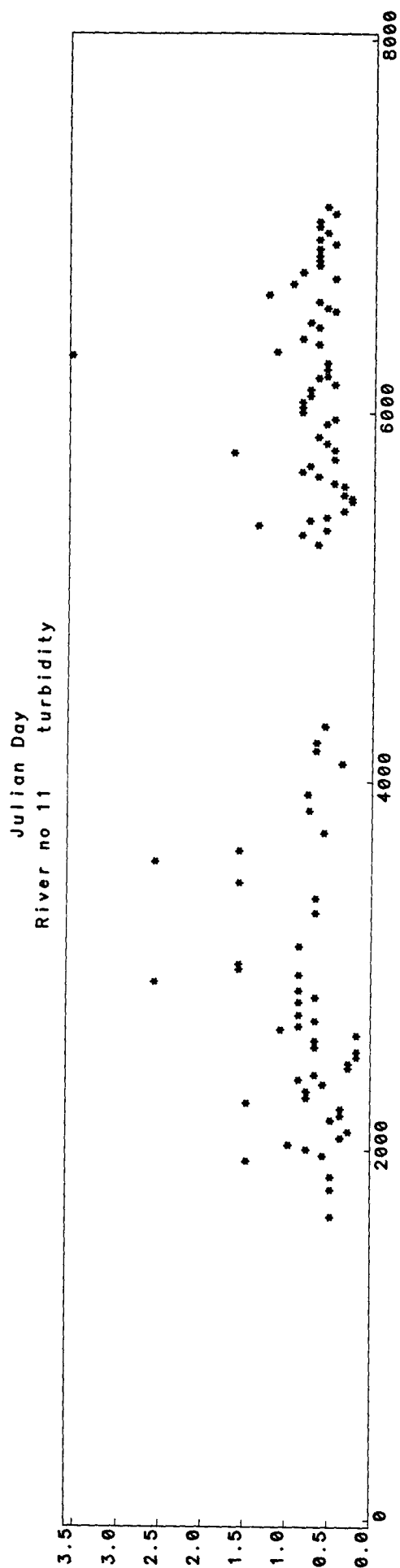
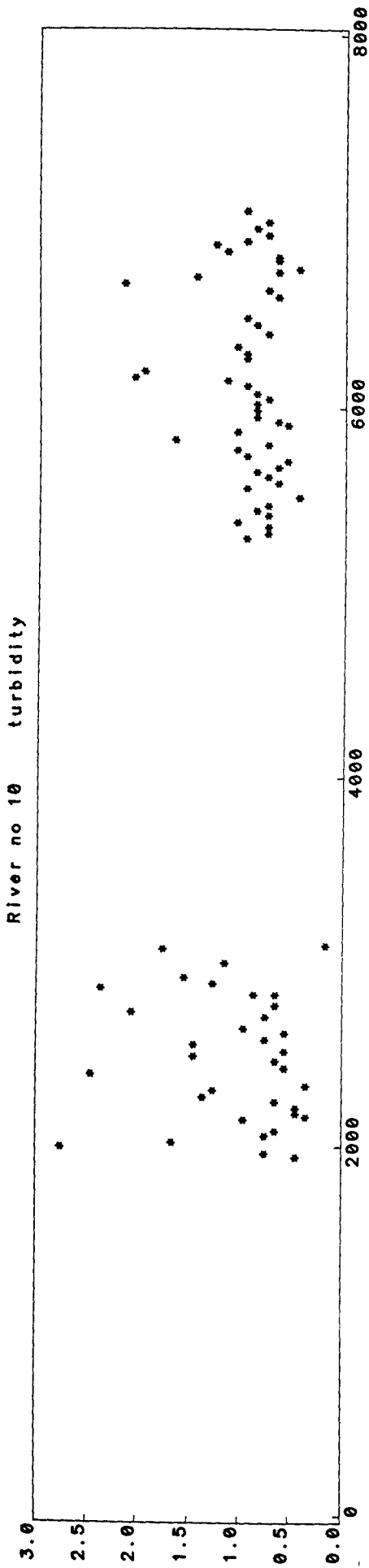

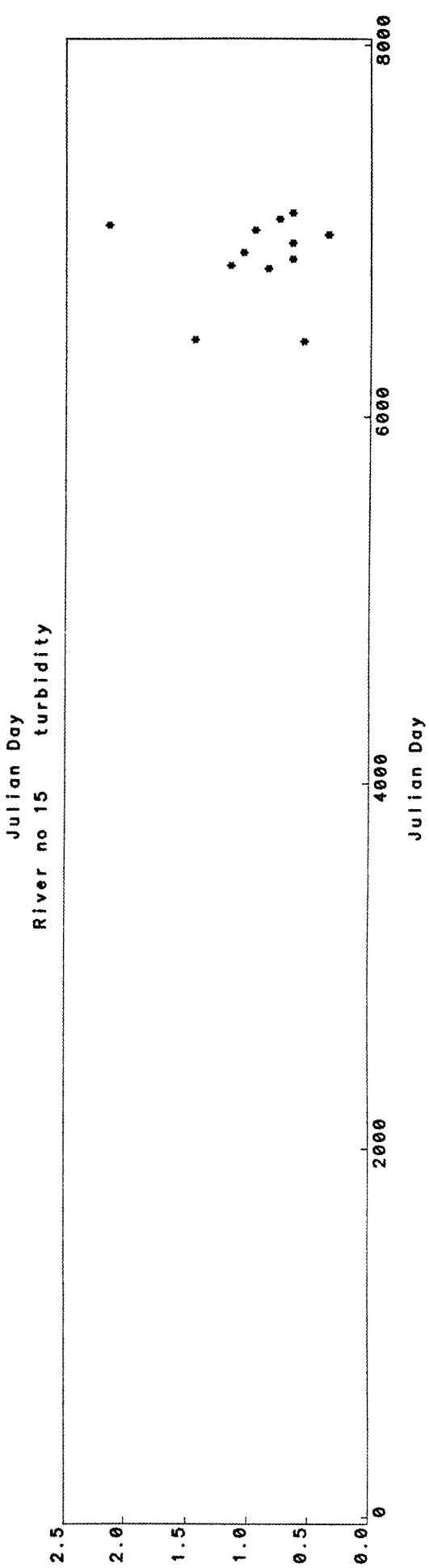
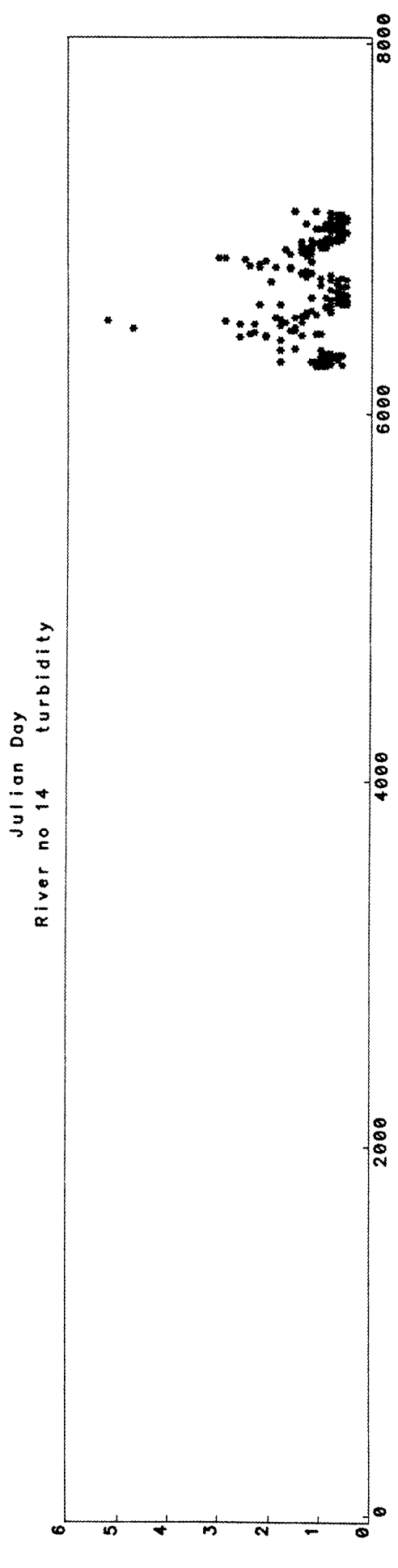
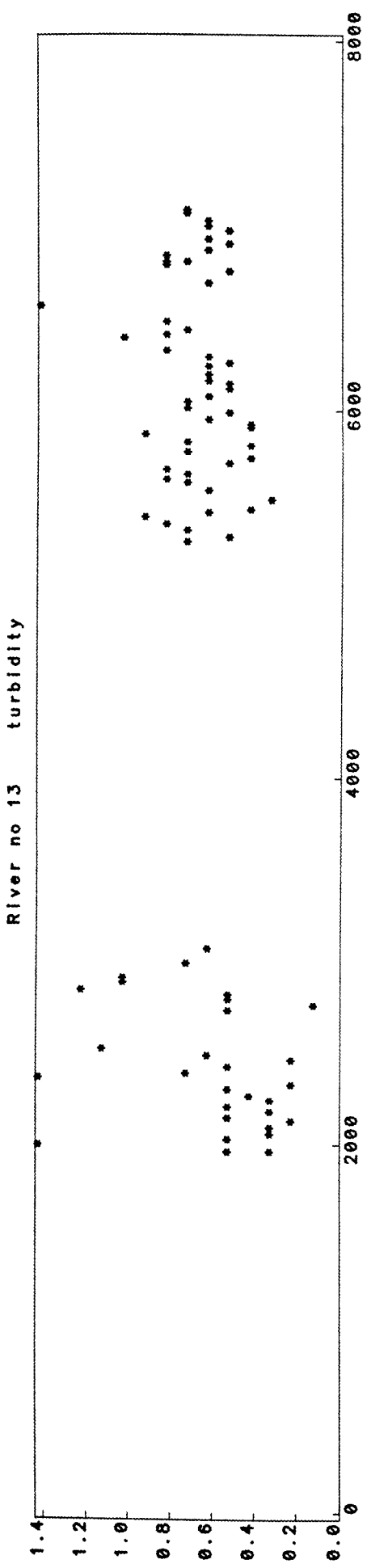

River no 16 colour

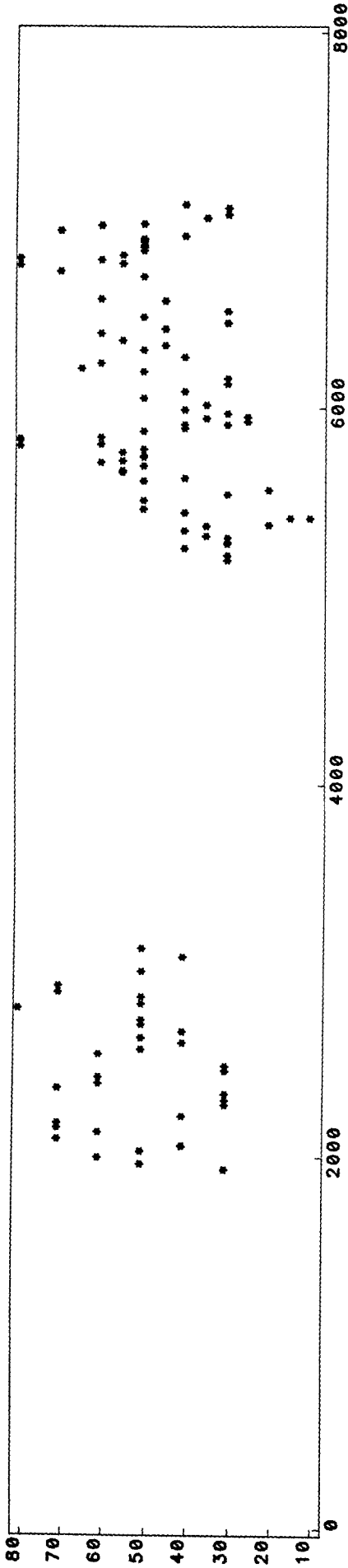

Julian Day  
River no 17 colour

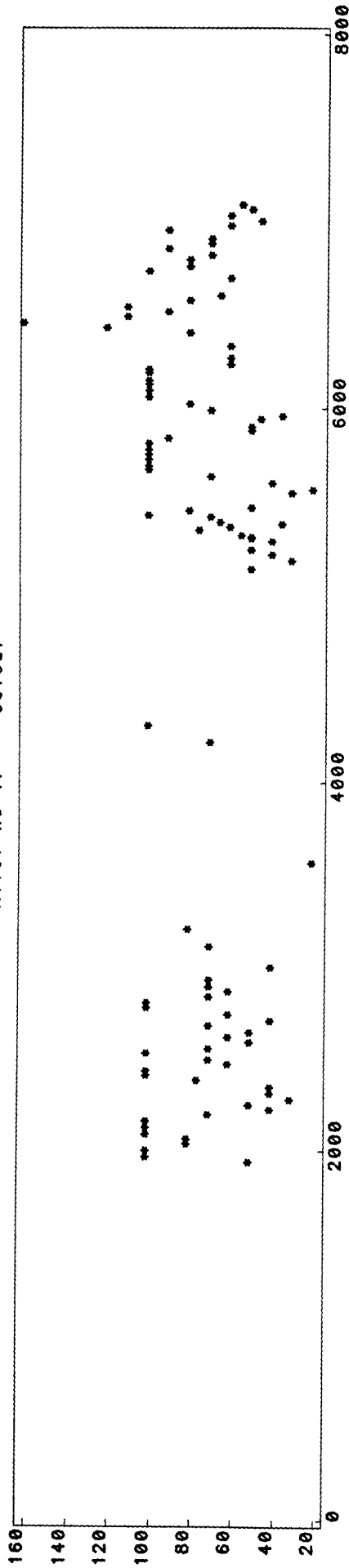

Julian Day  
River no 18 colour

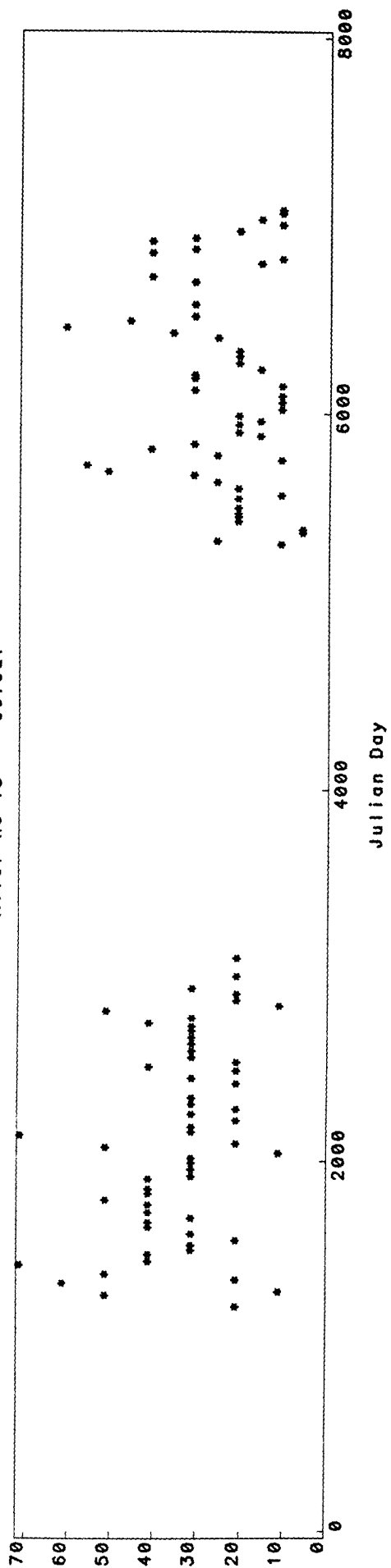



River no 19 turbidity

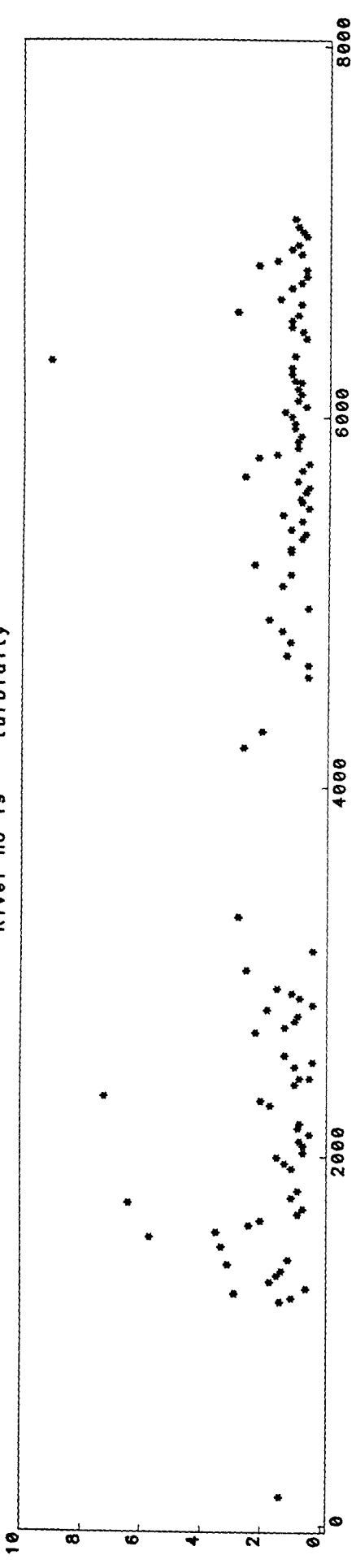

River no 20 turbidity

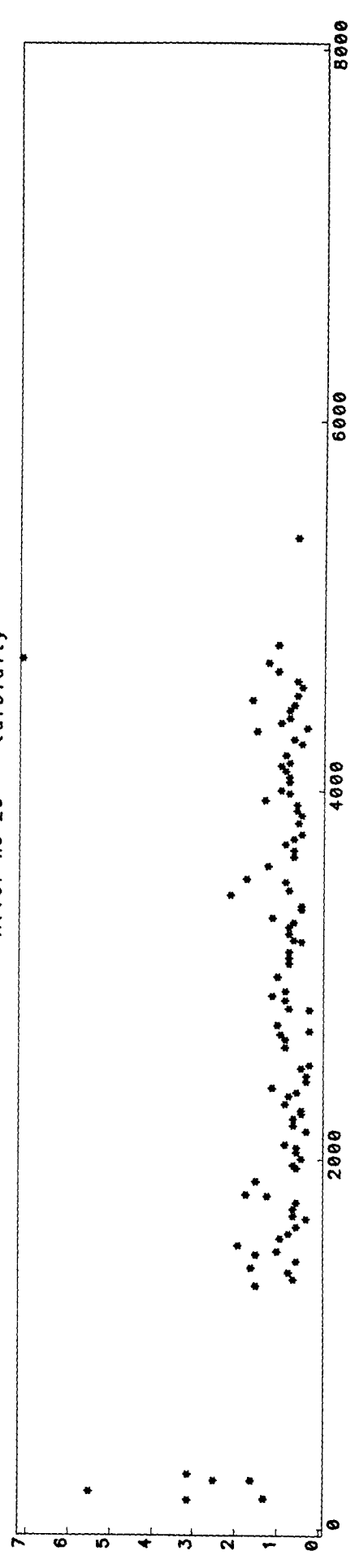

River no 21 turbidity

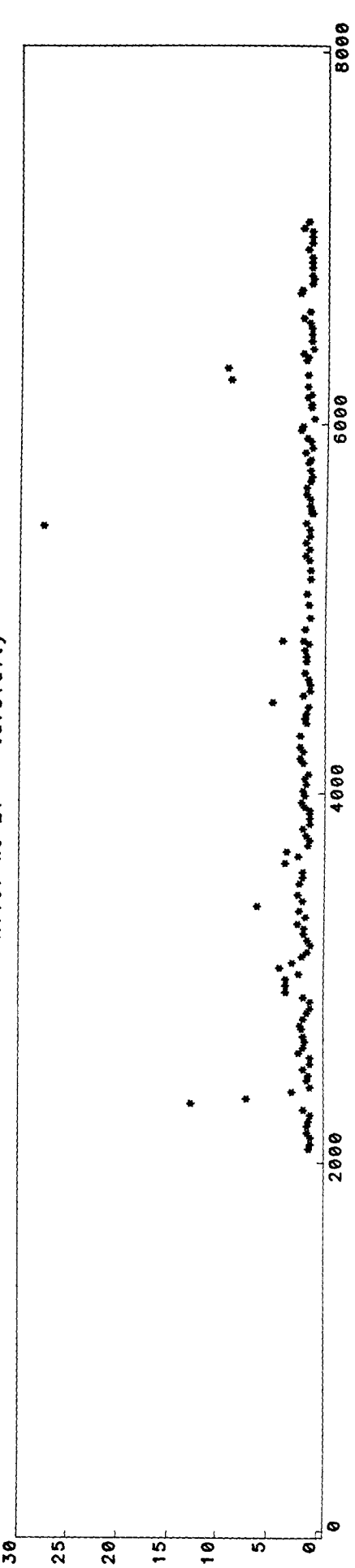

River no 22 turbidity

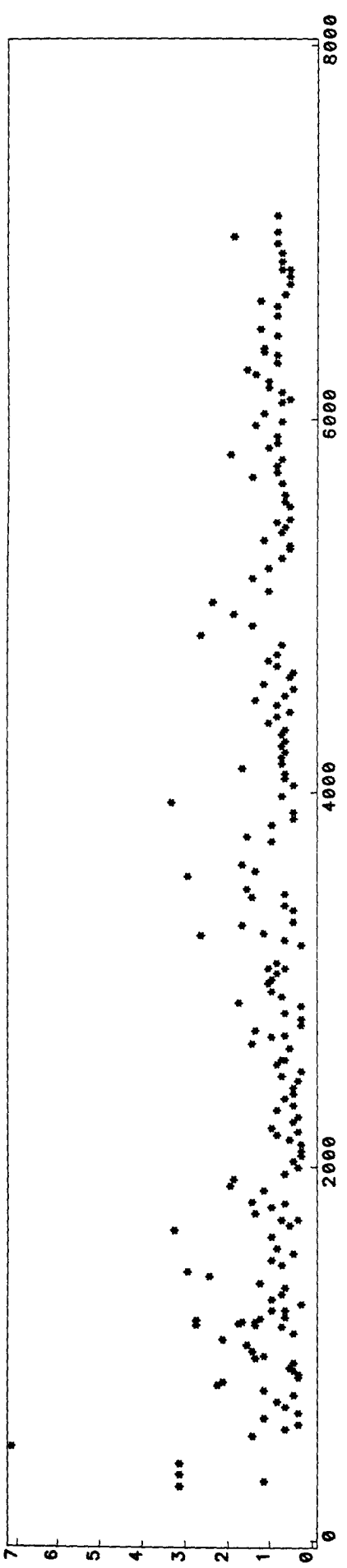

River no 23 turbidity

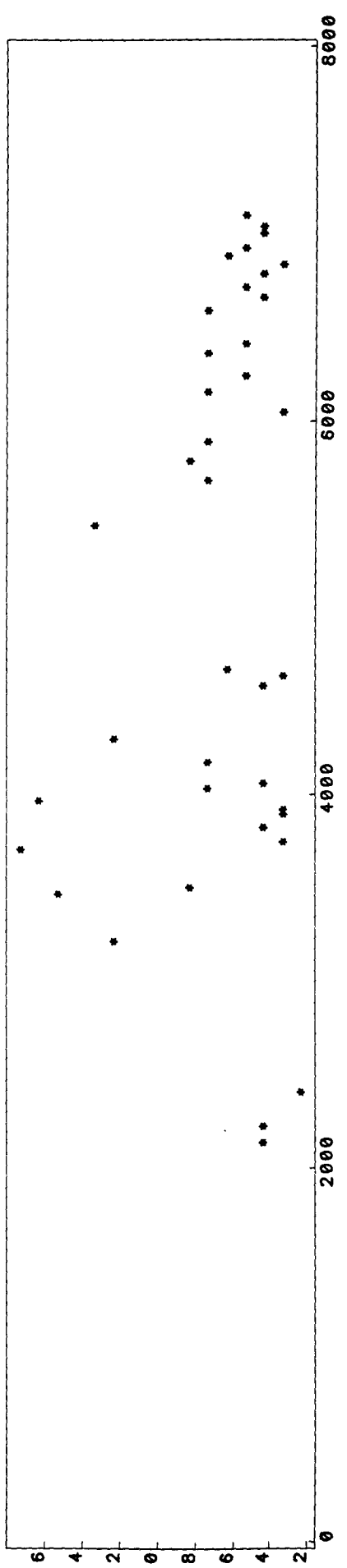

River no 24 turbidity

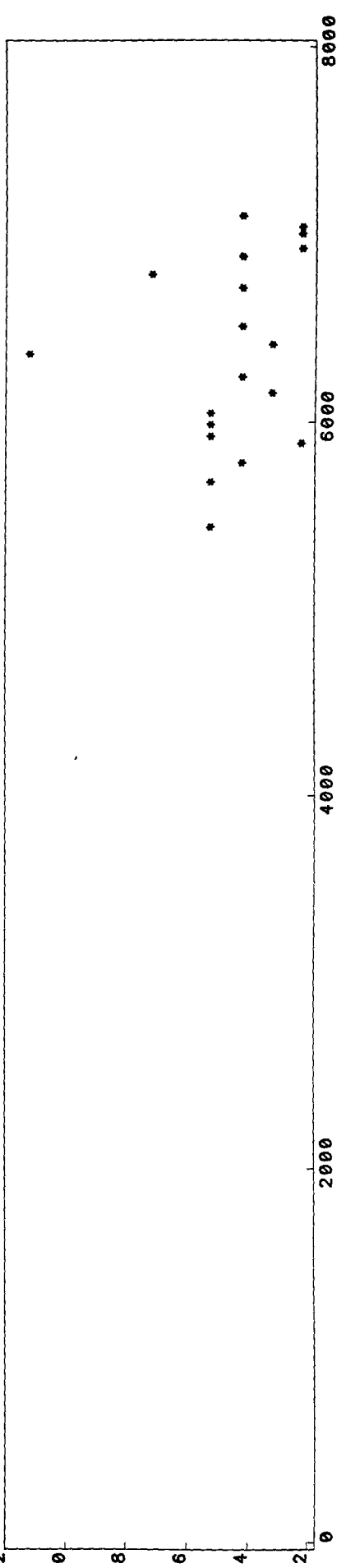

River no 25 turbidity

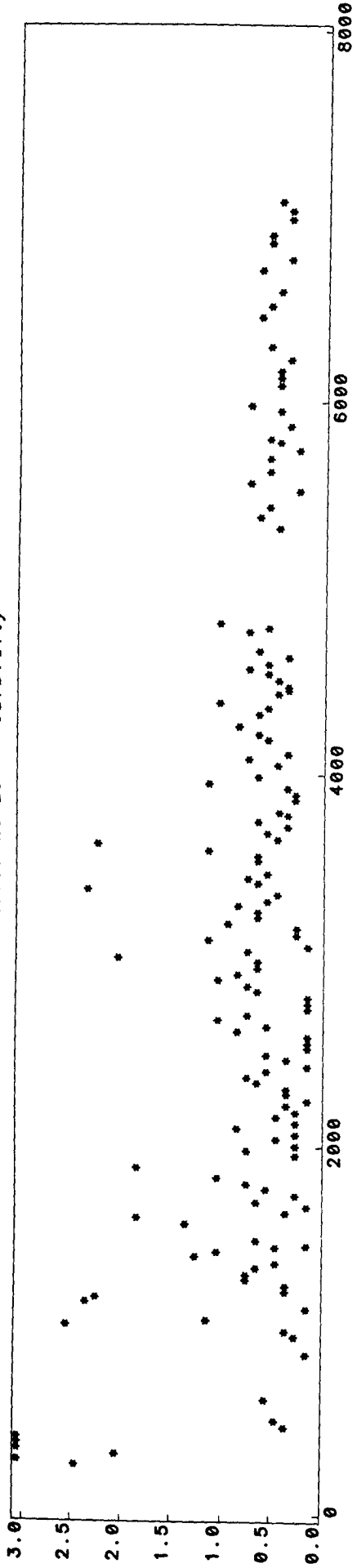

River no 26 turbidity

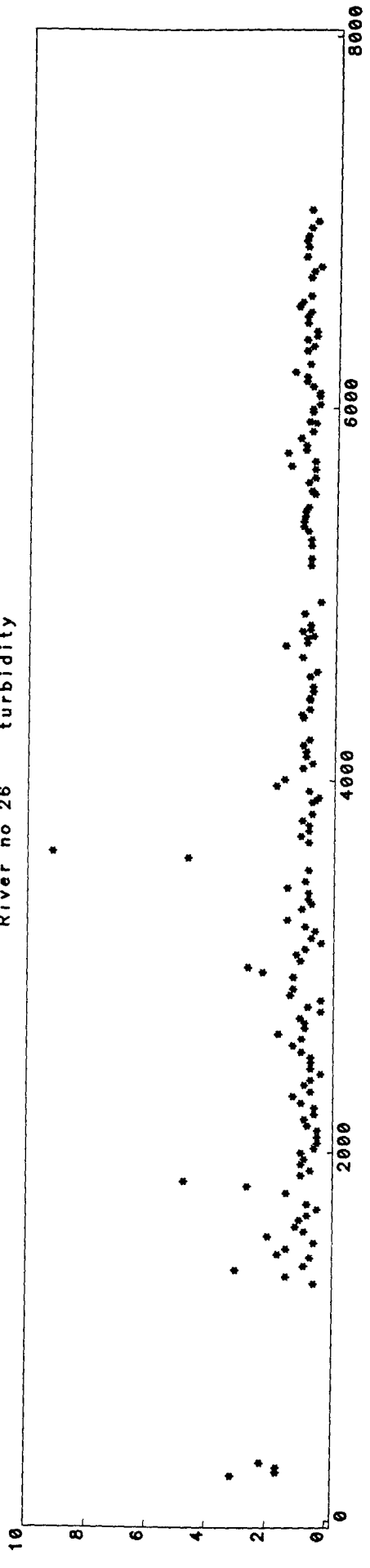

River no 27 turbidity

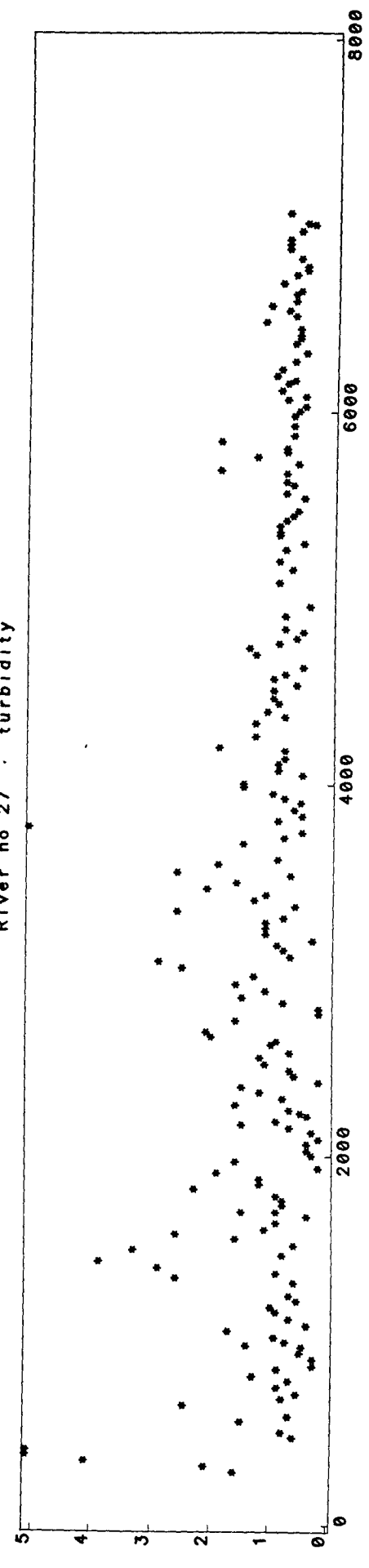

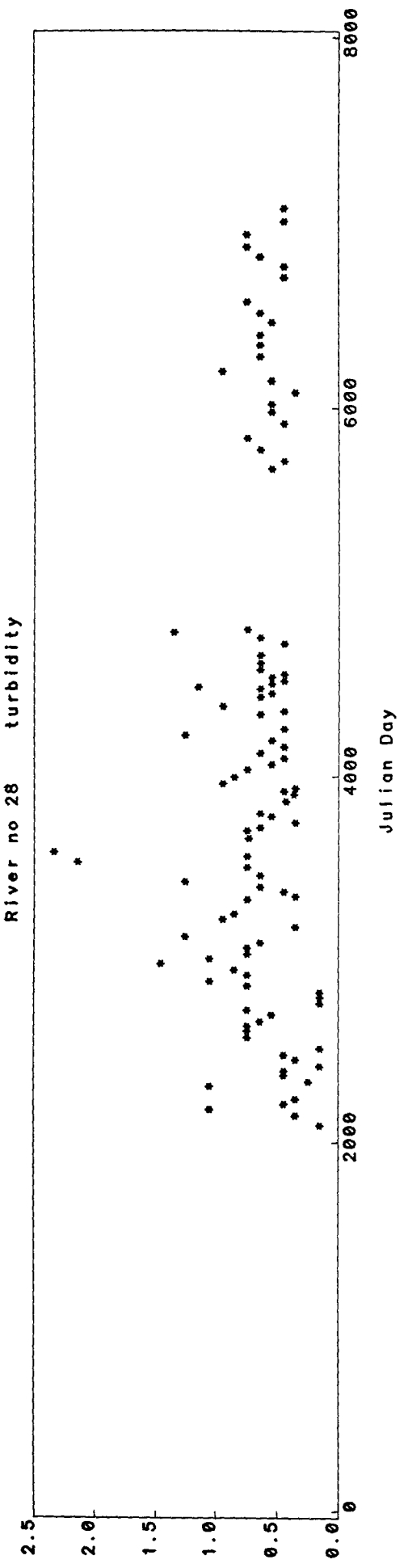

Appendix 9. Scatter plots of sodium for the study rivers.

River no 1 Na

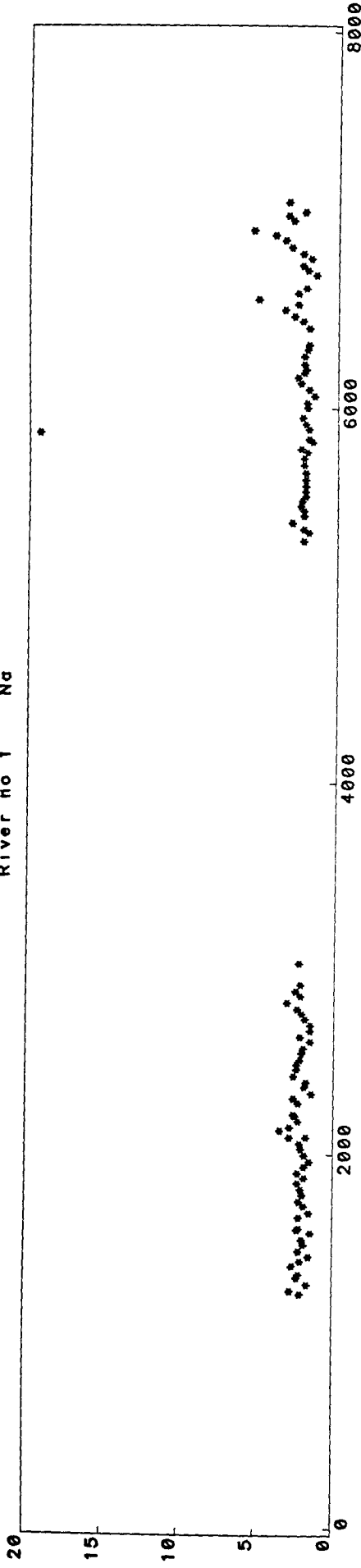

Julian Day  
River no 2 Na

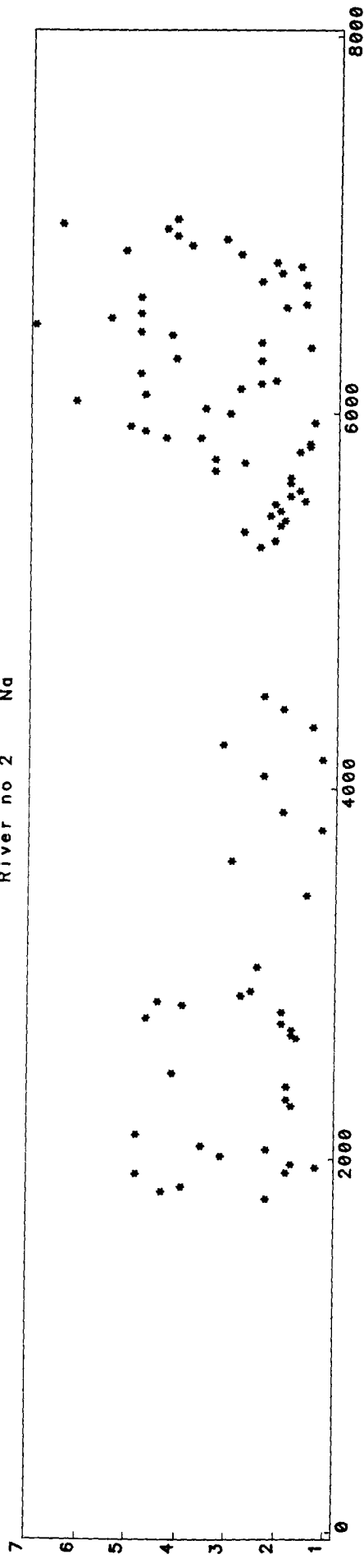

Julian Day  
River no 3 Na

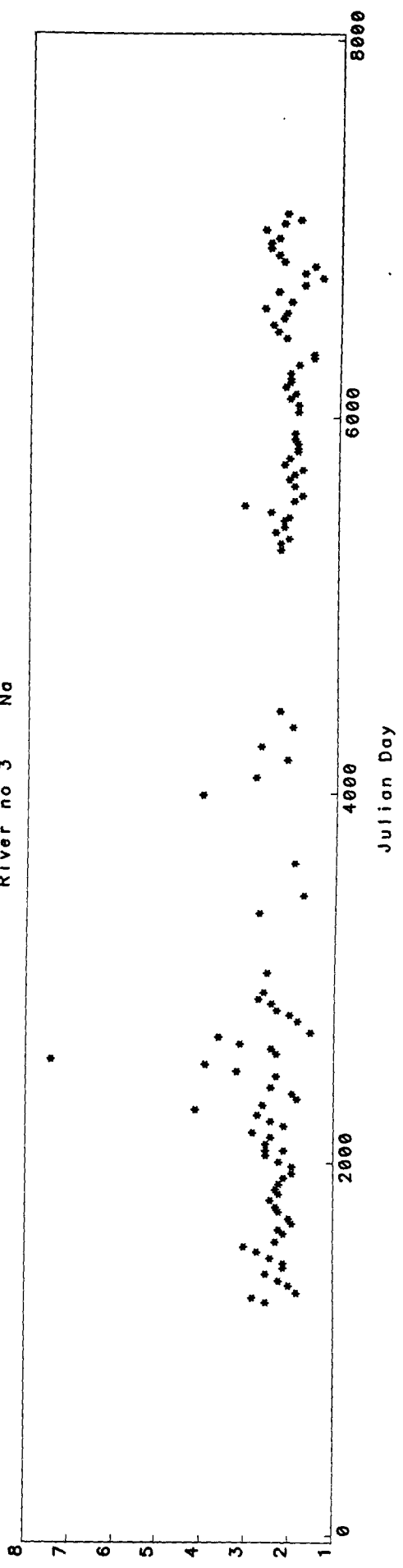

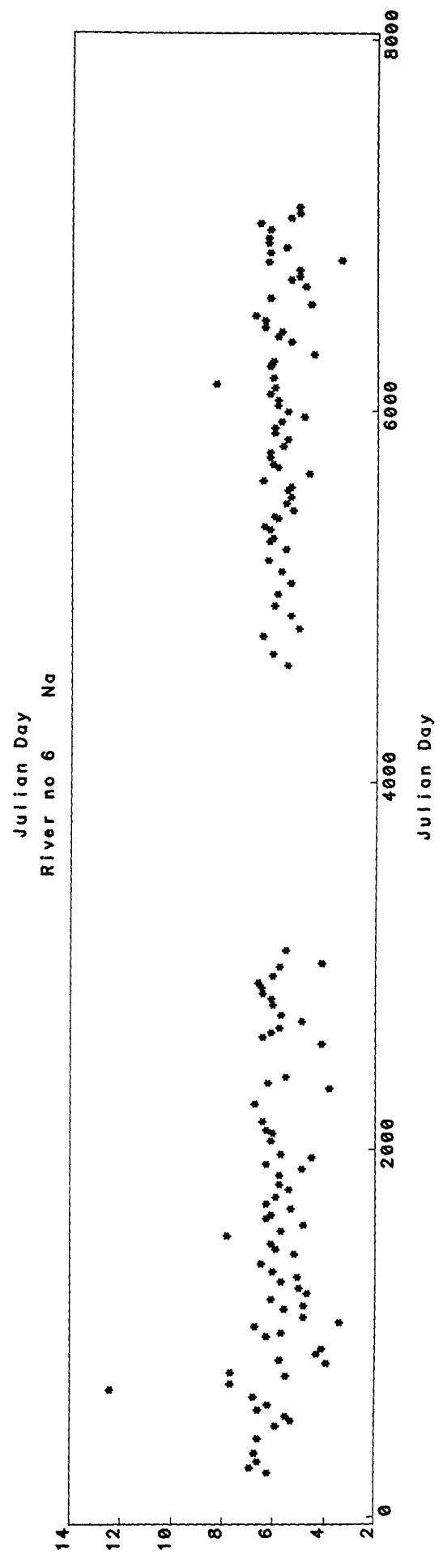
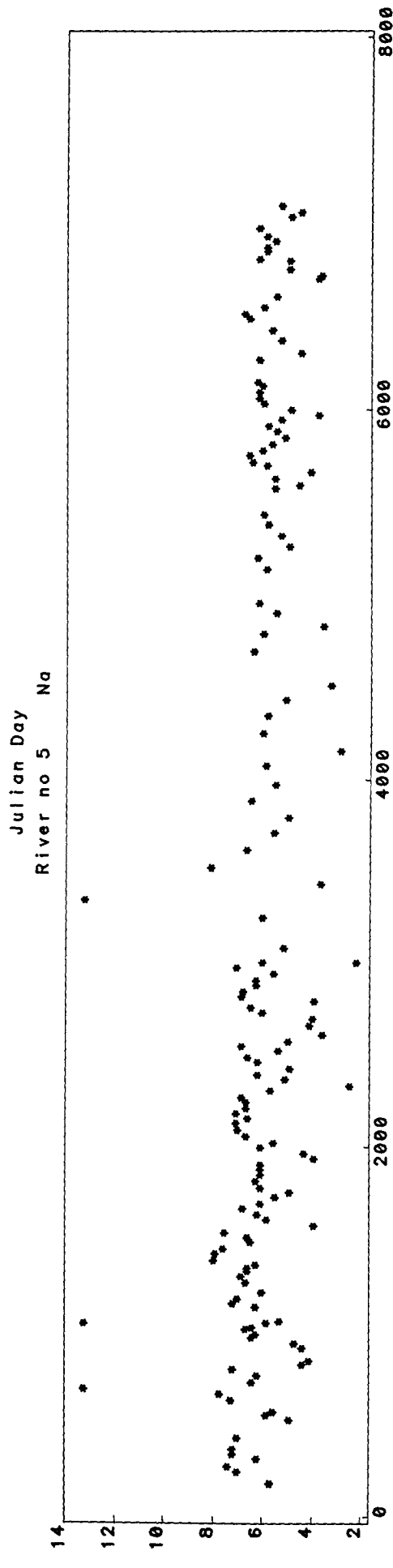
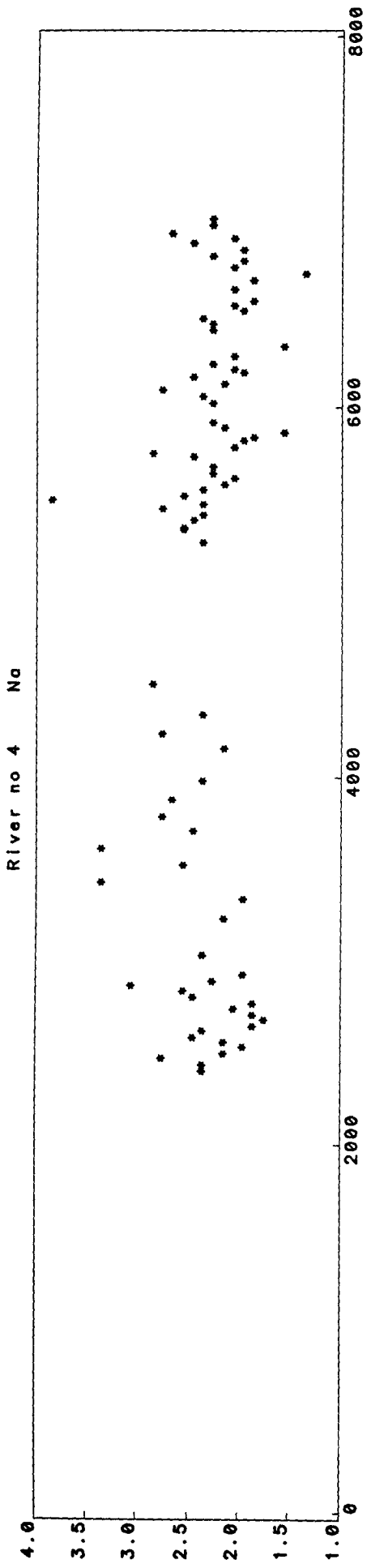

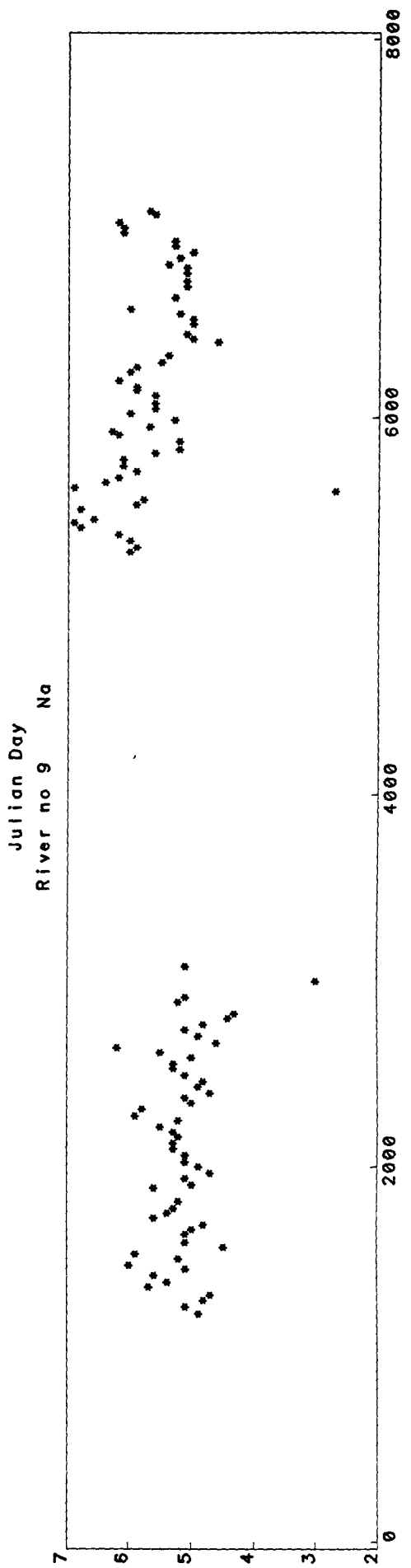
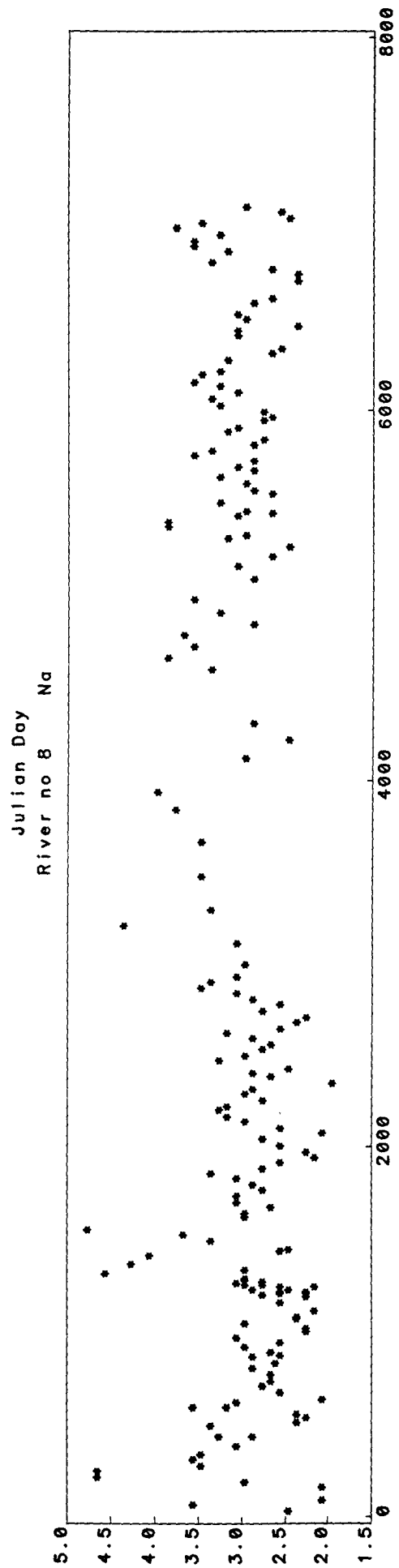
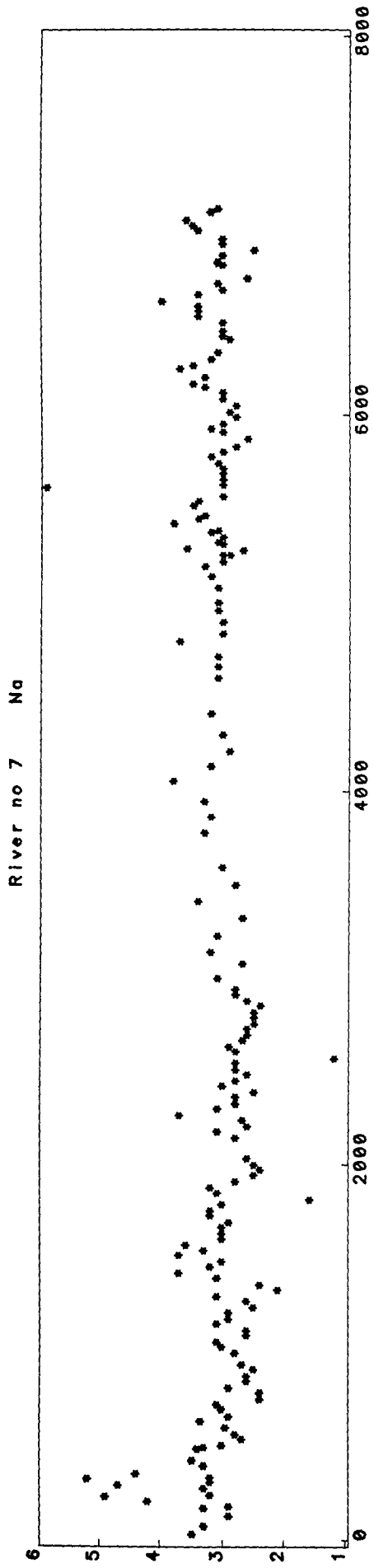



River no 10 Na

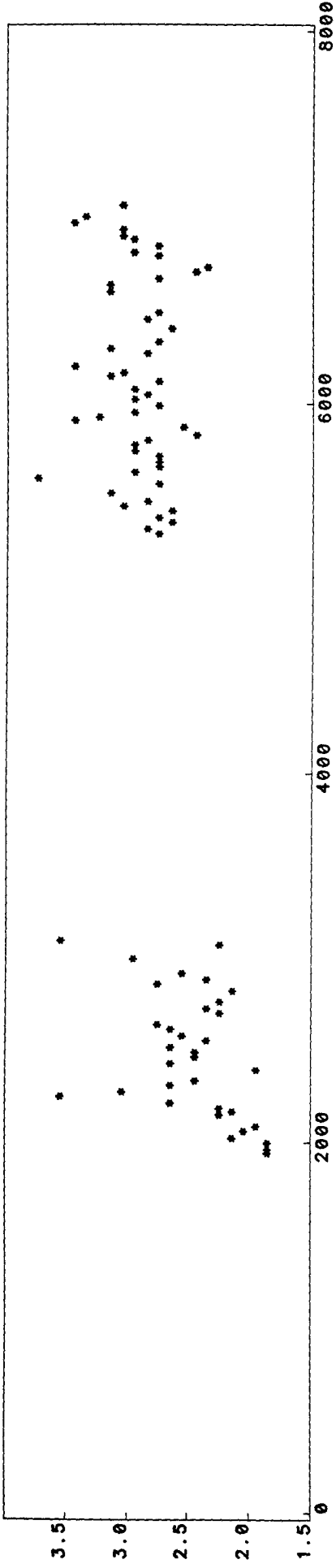

Julian Day  
River no 11 Na

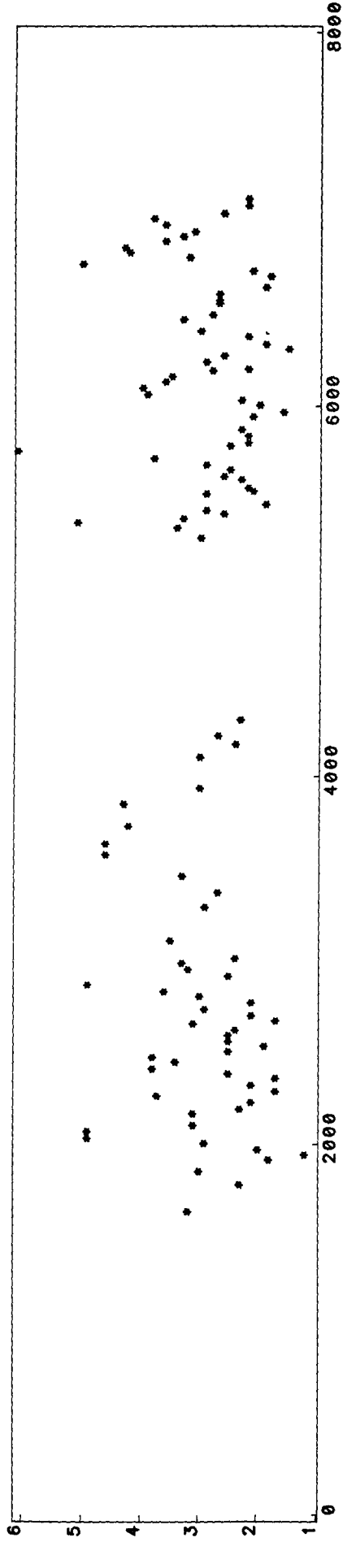

Julian Day  
River no 12 Na

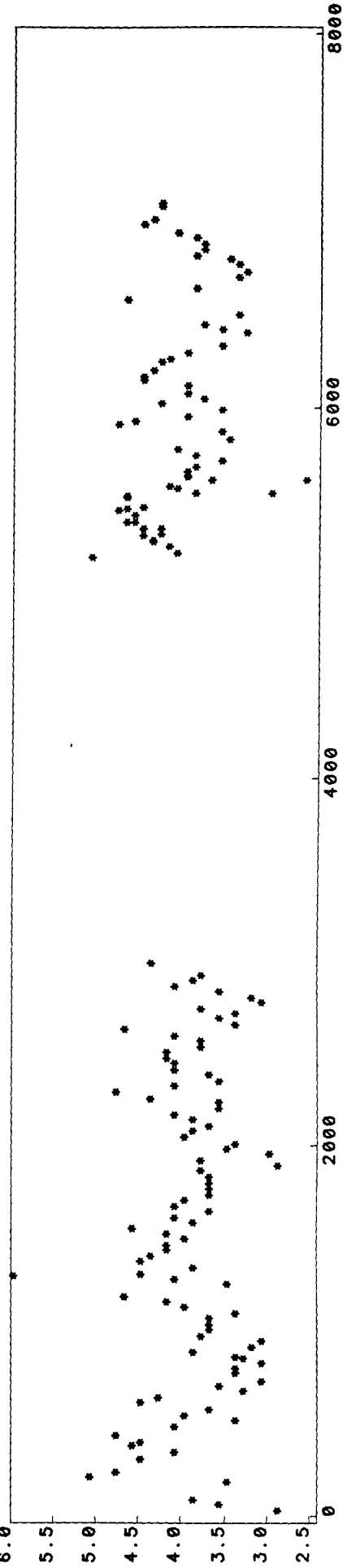

River no 13 Na

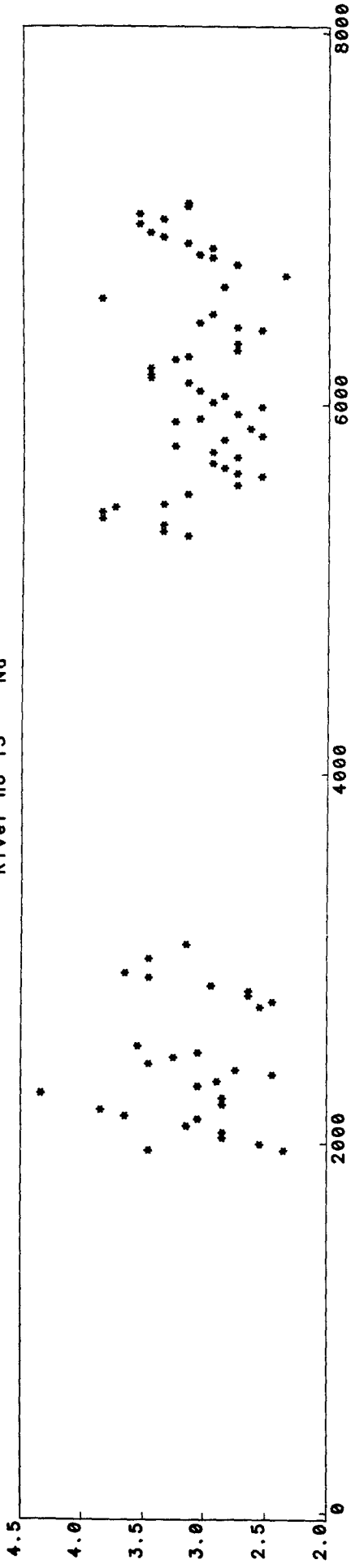

Julian Day  
River no 16 Na

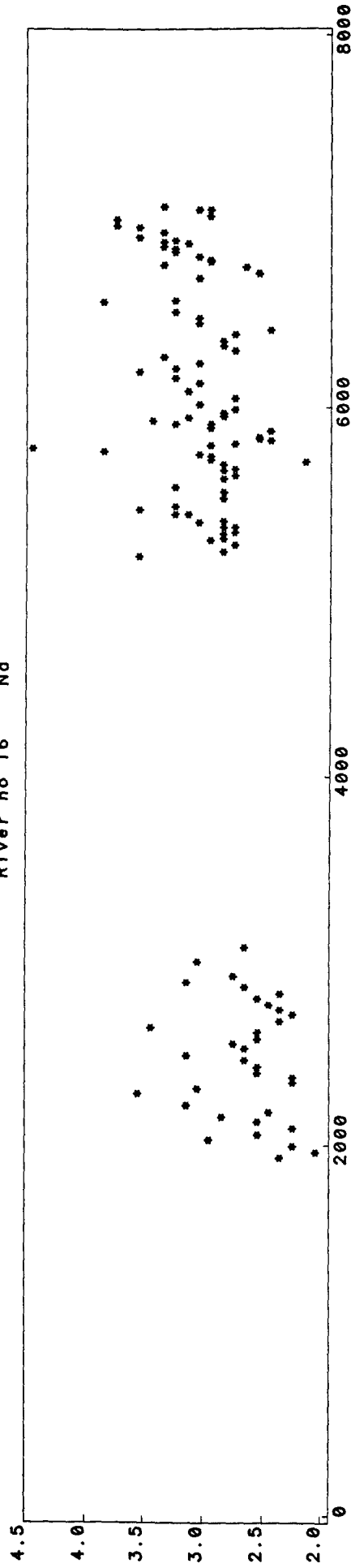

Julian Day  
River no 17 Na

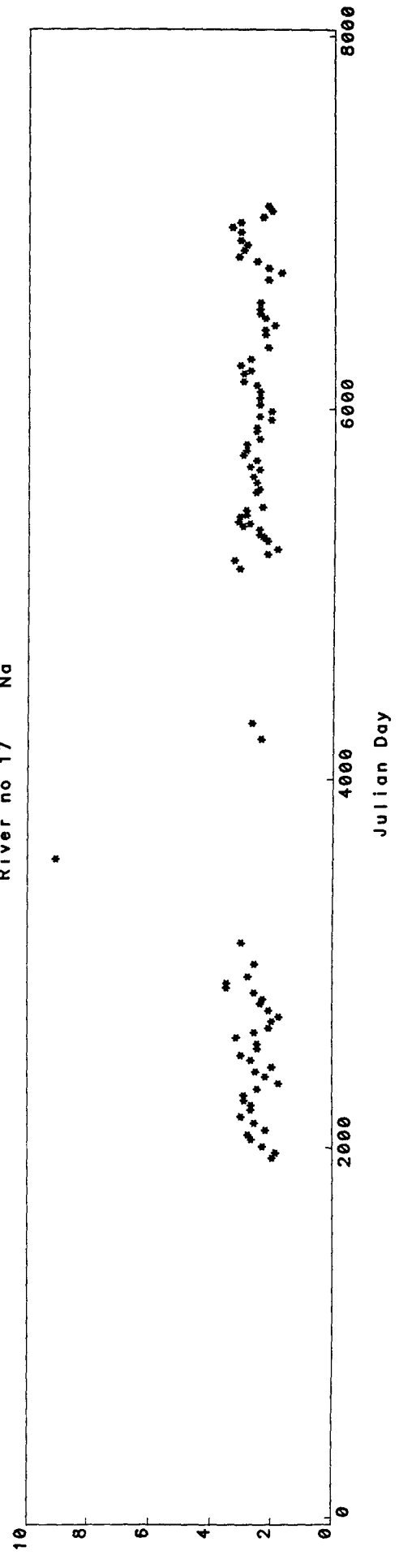

River no 18 Na

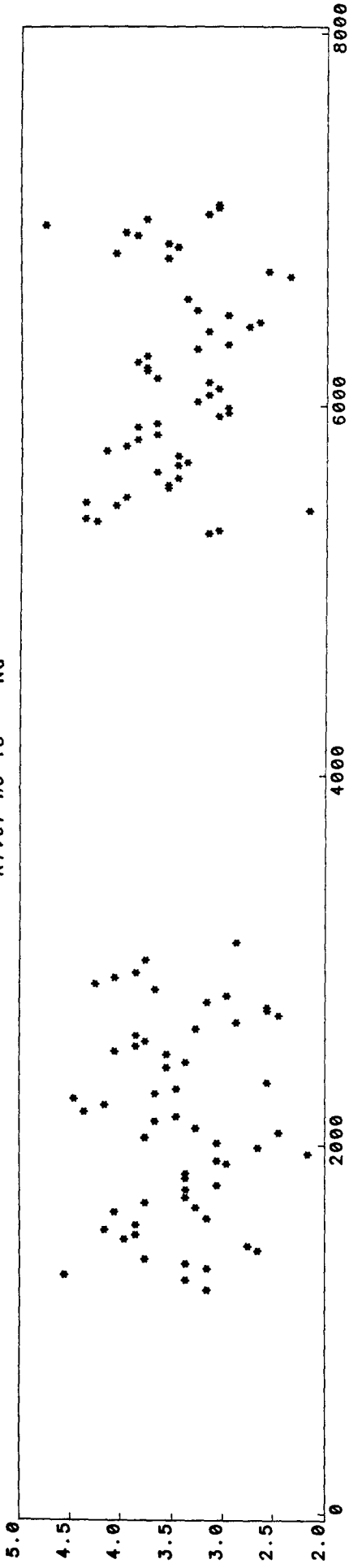

Julian Day  
River no 19 Na

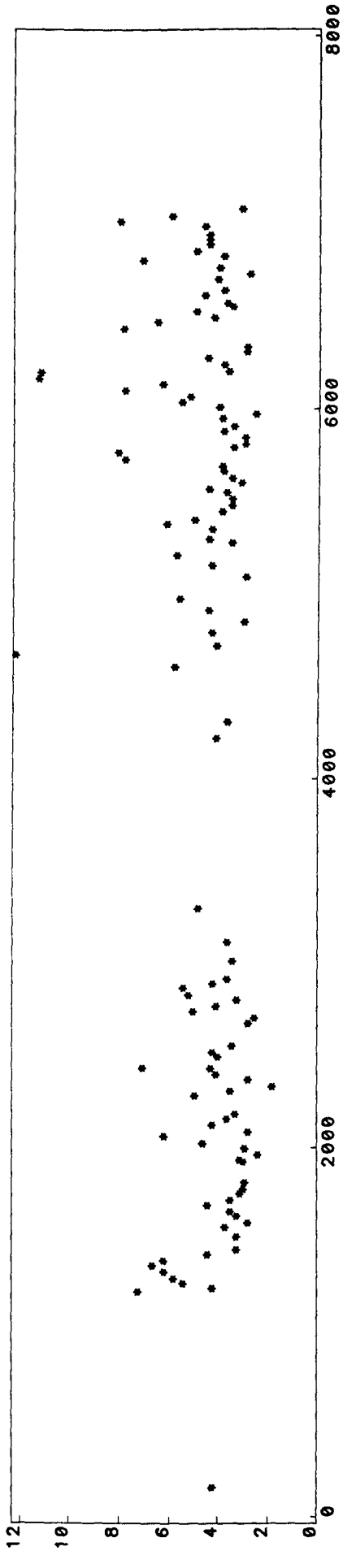

Julian Day  
River no 20 Na

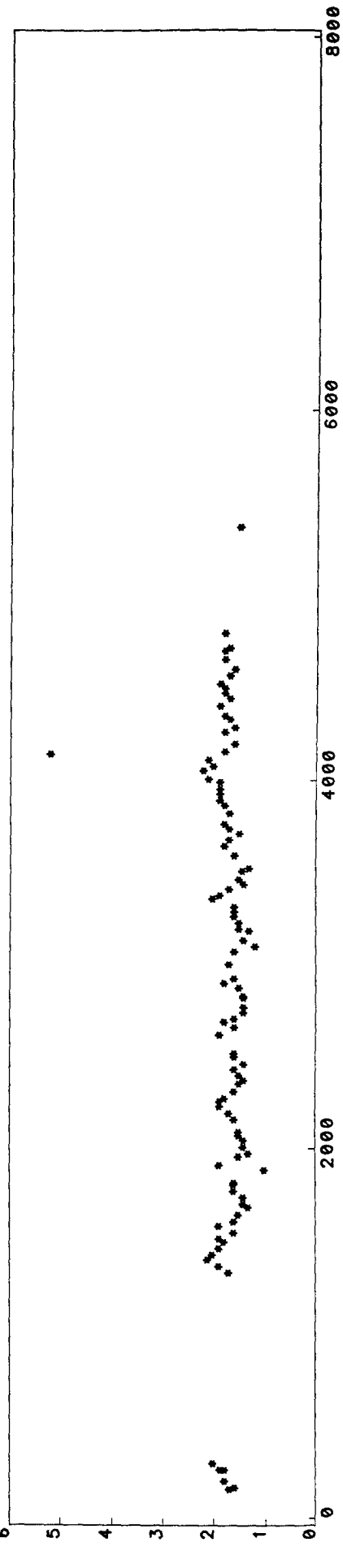

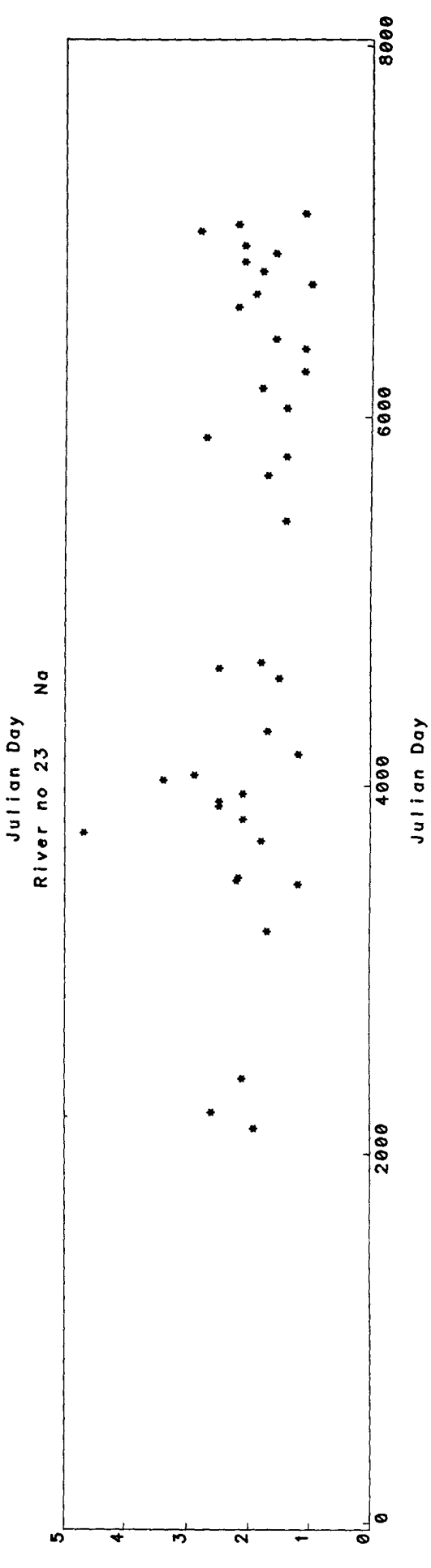
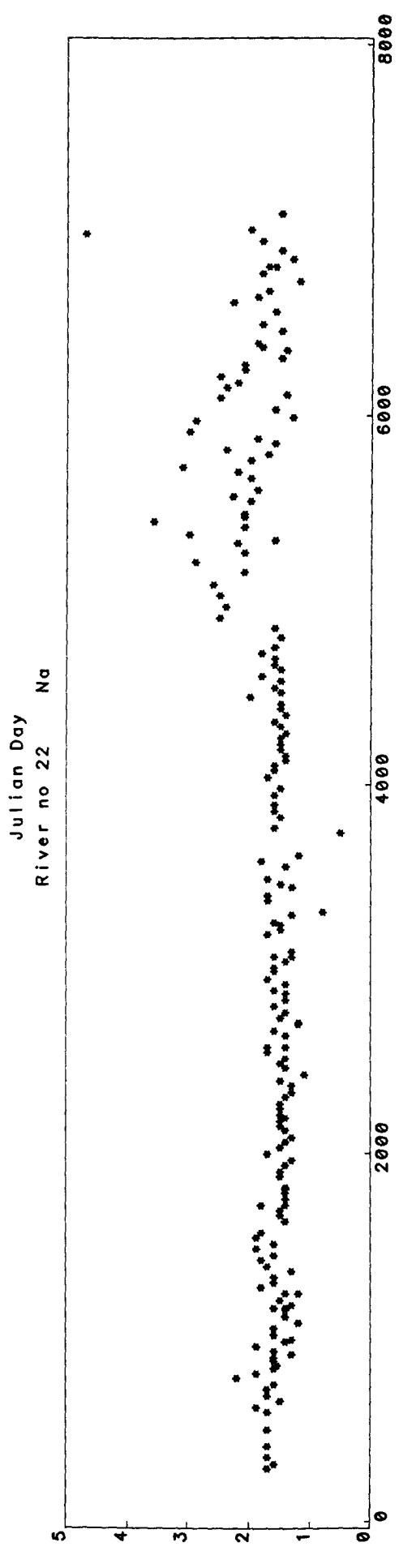
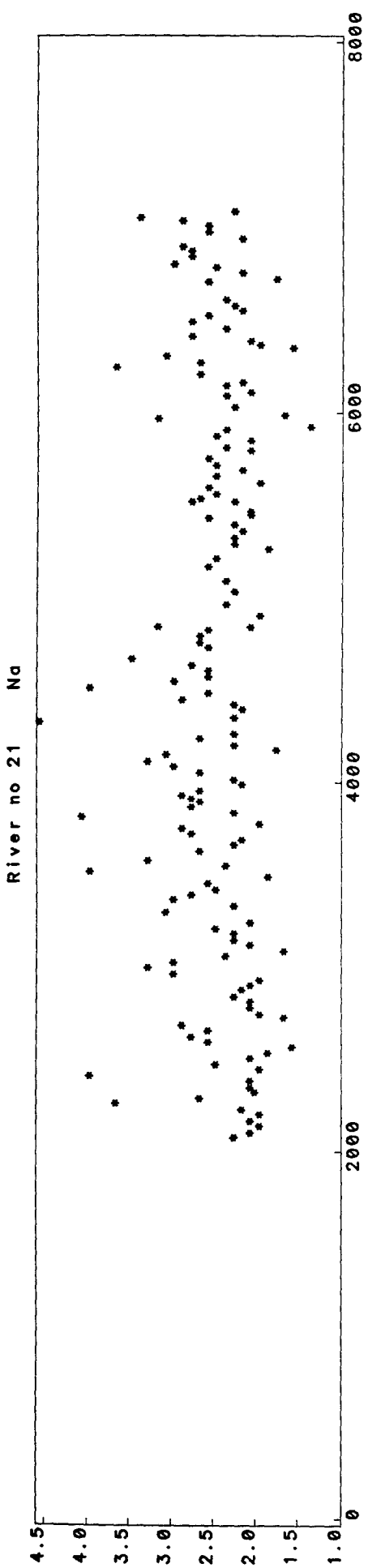

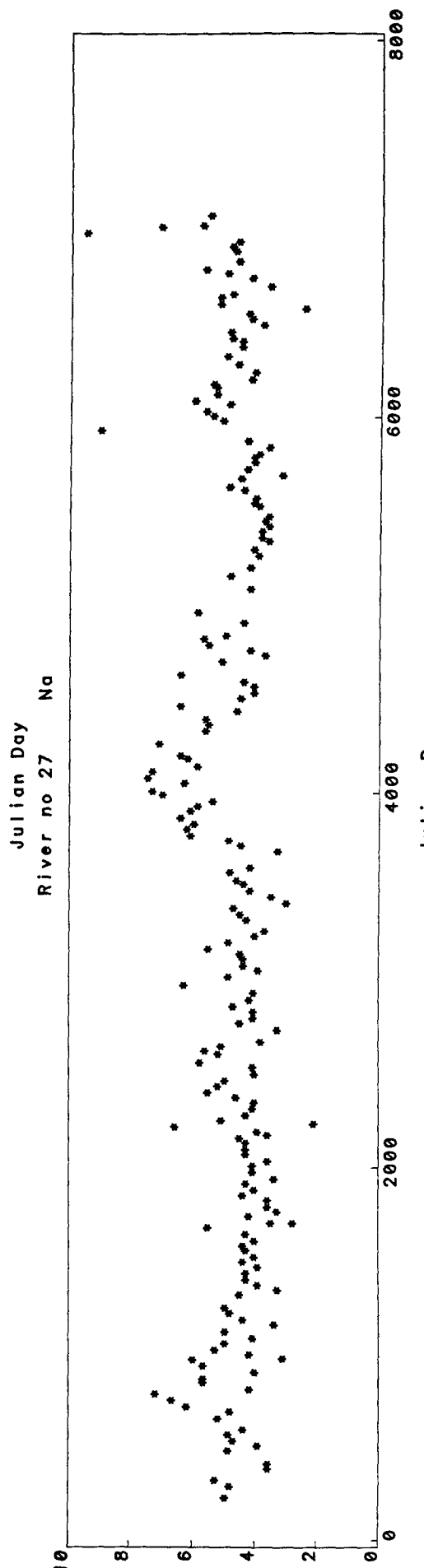
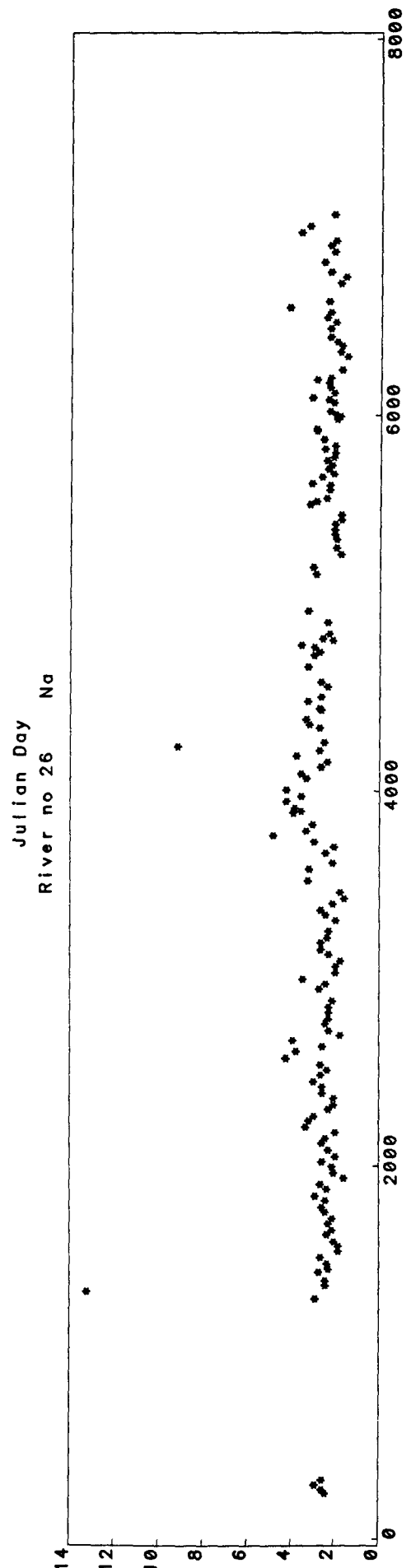
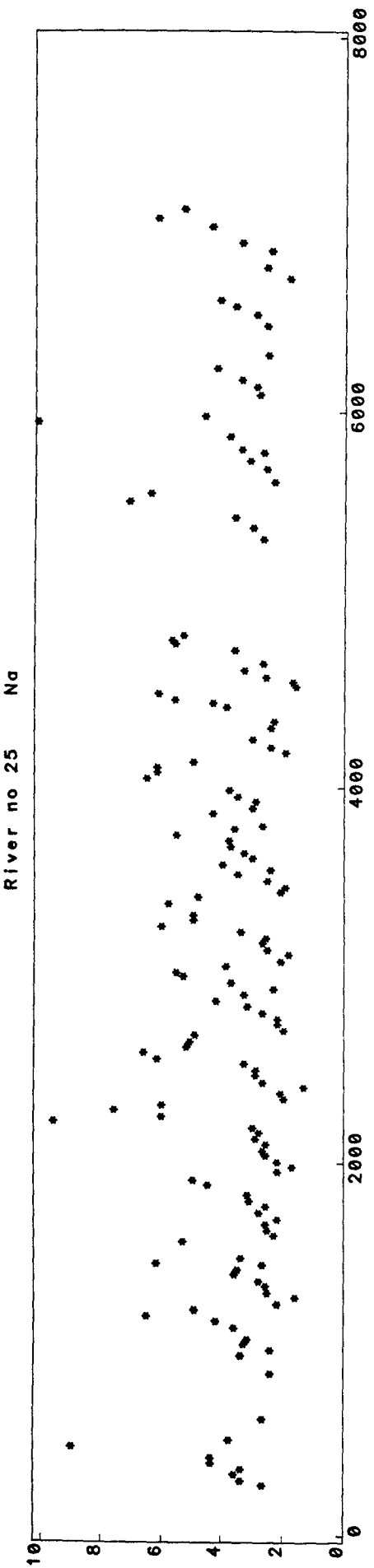

River no 28 Na

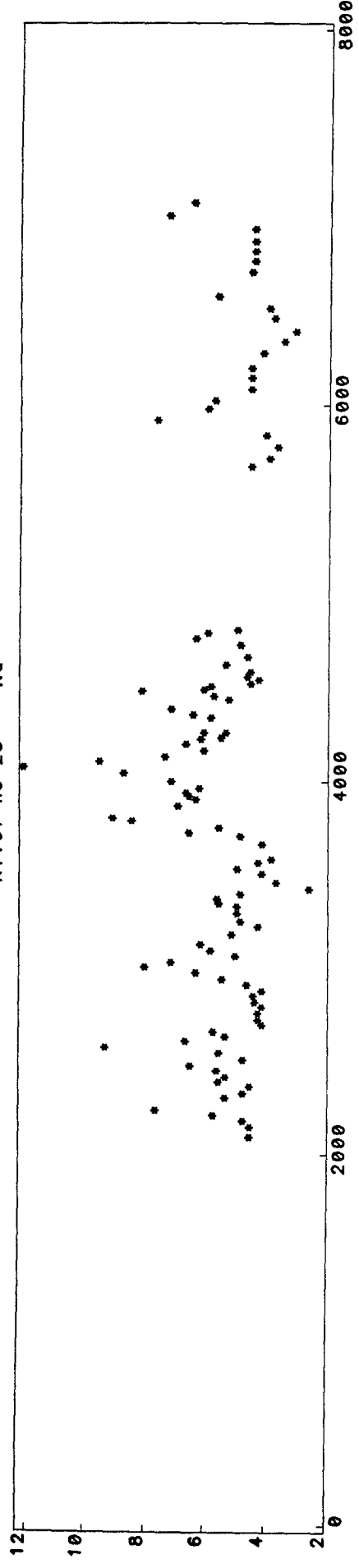

Appendix 10. Running boxplots of excess sulfate calculated by magnesium ratio for the study rivers.

- 6 months.

River no 1 Excess SO4 (Mg)

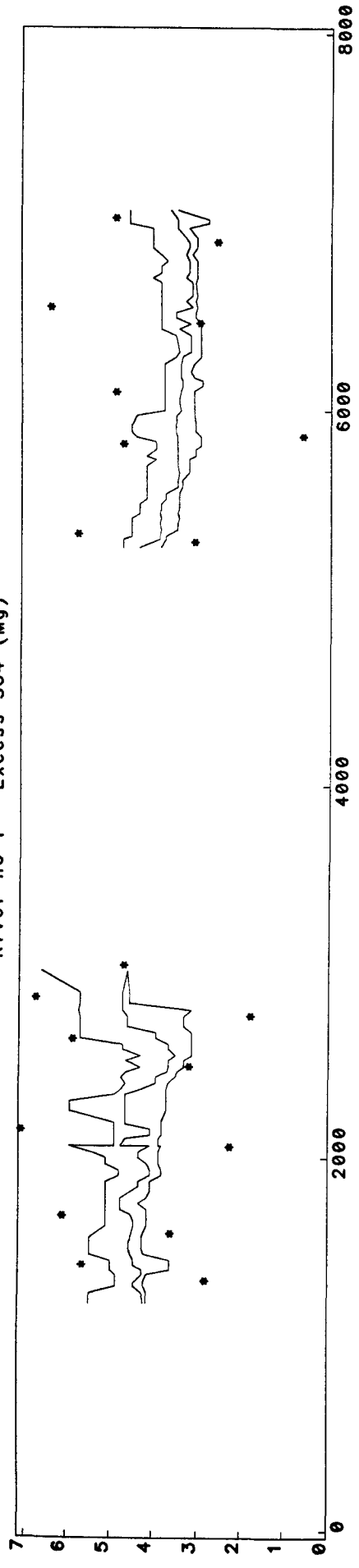

River no 2 Excess SO4 (Mg)

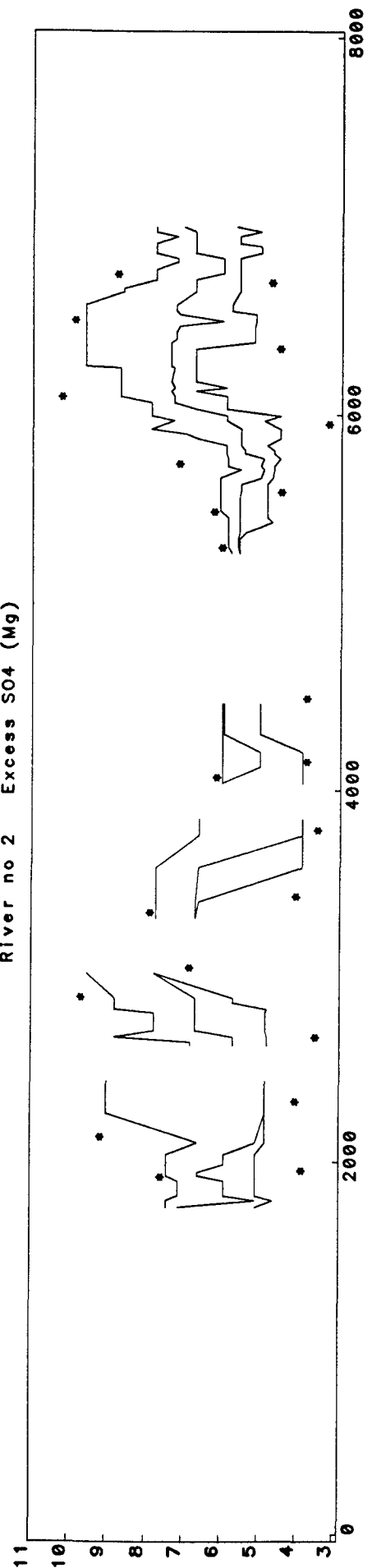

River no 3 Excess SO4 (Mg)

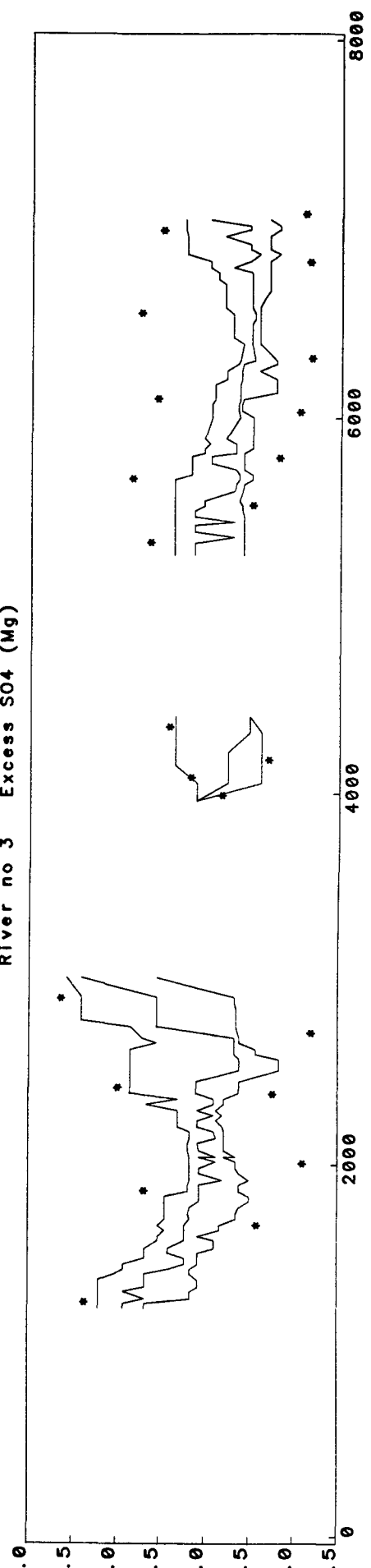

Julian Day



River no 4 Excess SO4 (Mg)

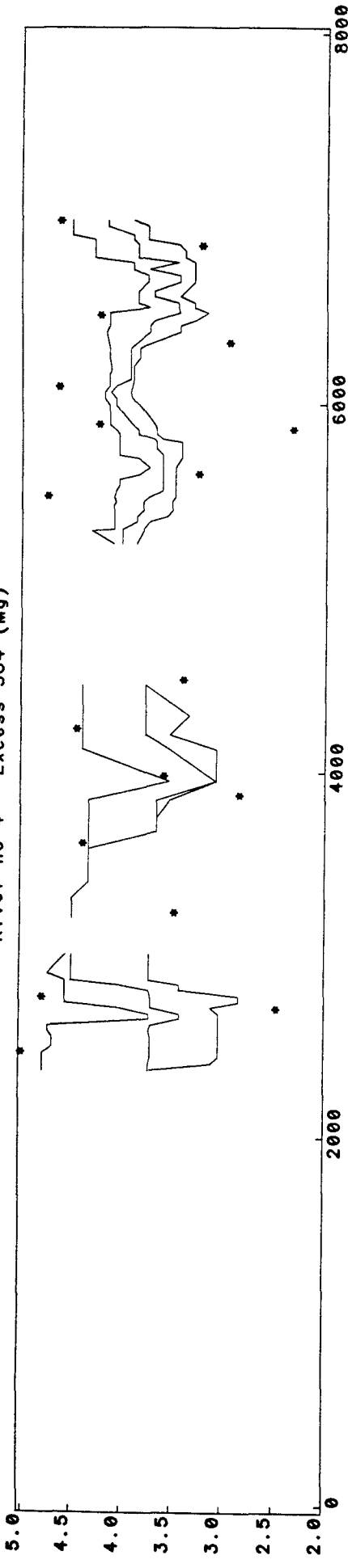

River no 5 Excess SO4 (Mg)

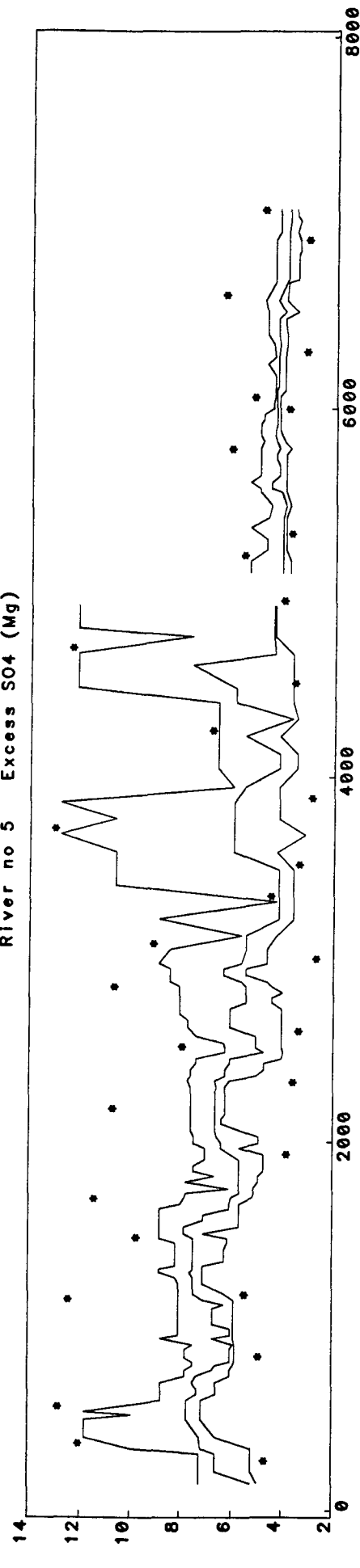

River no 6 Excess SO4 (Mg)

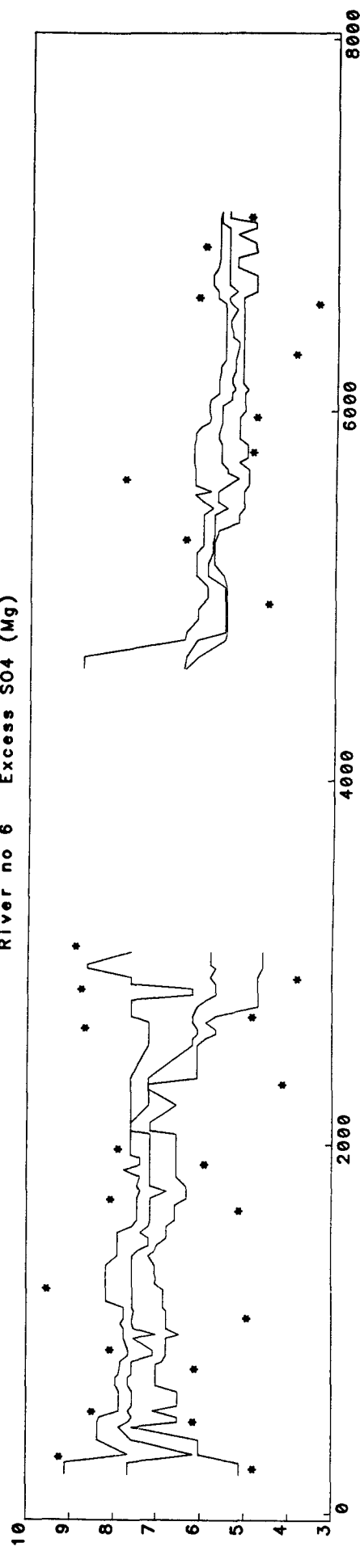

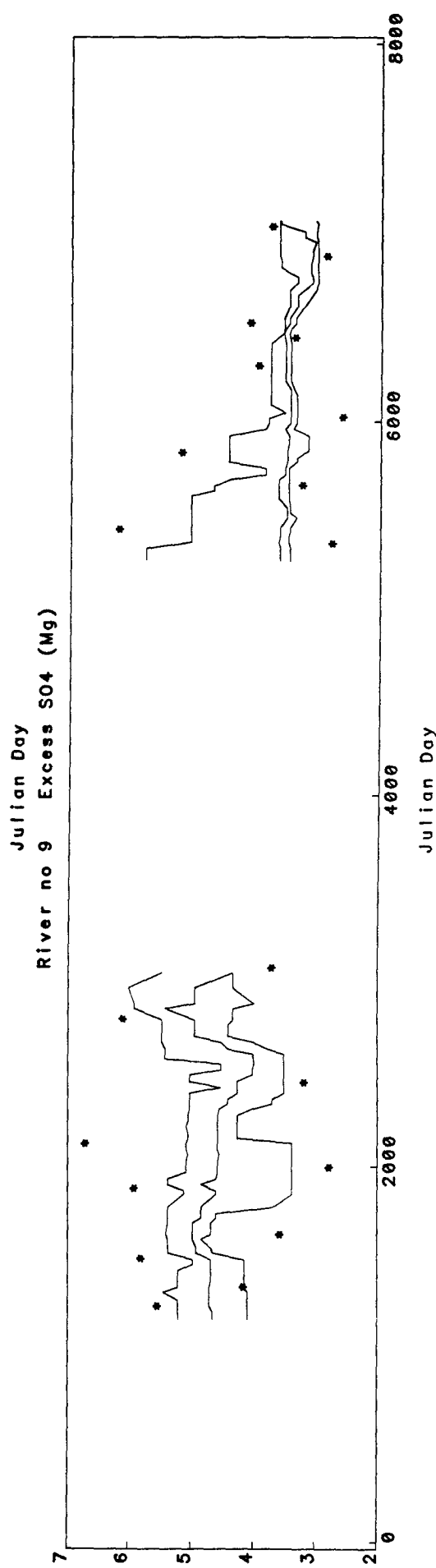
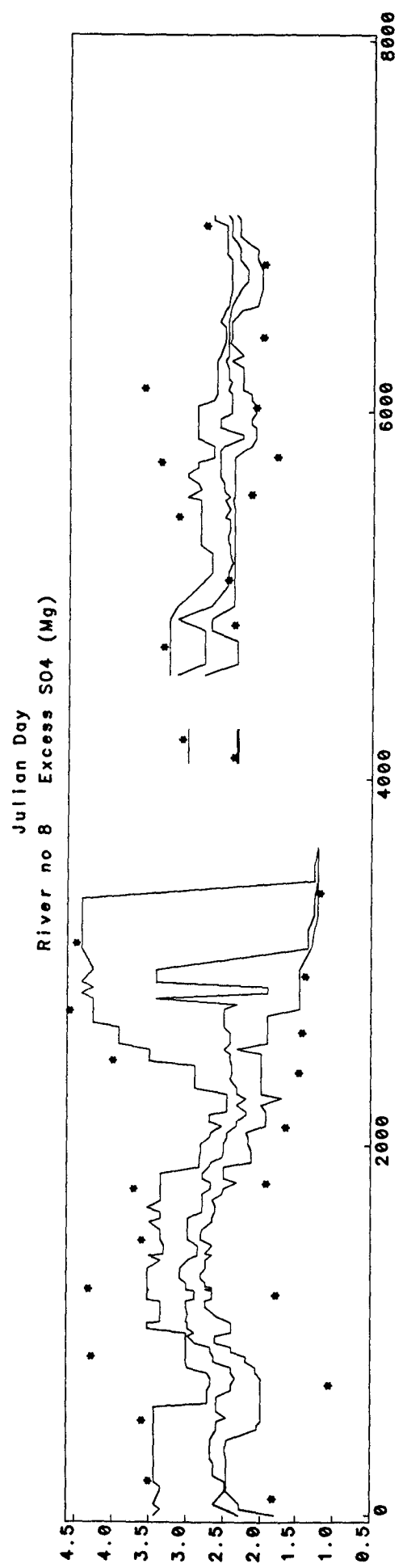
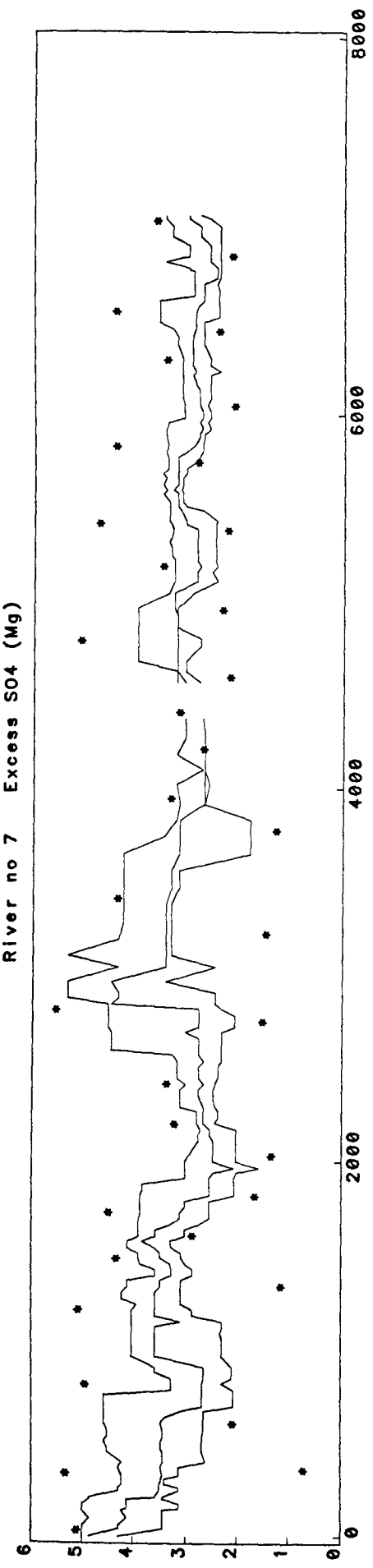

River no 10 Excess SO4 (Mg)

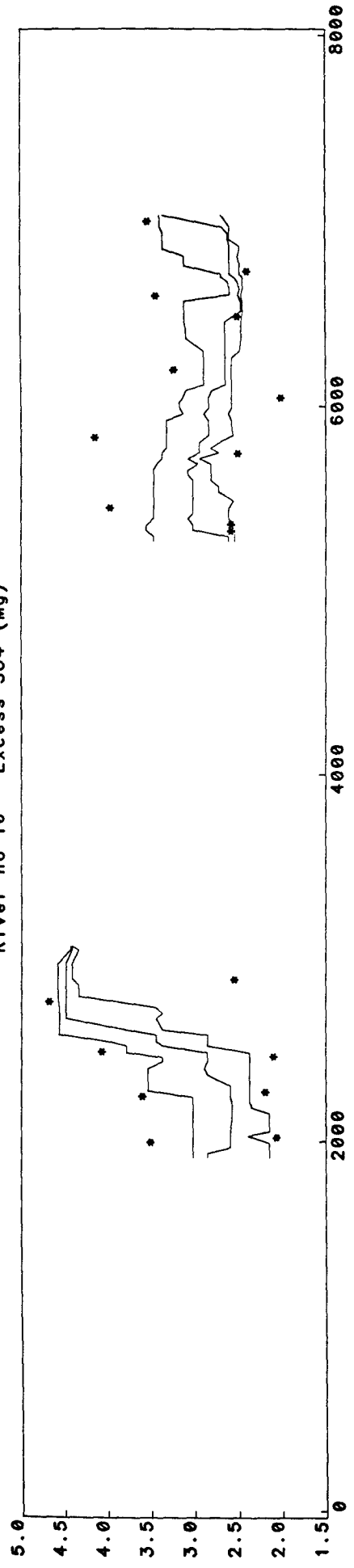

River no 11 Excess SO4 (Mg)

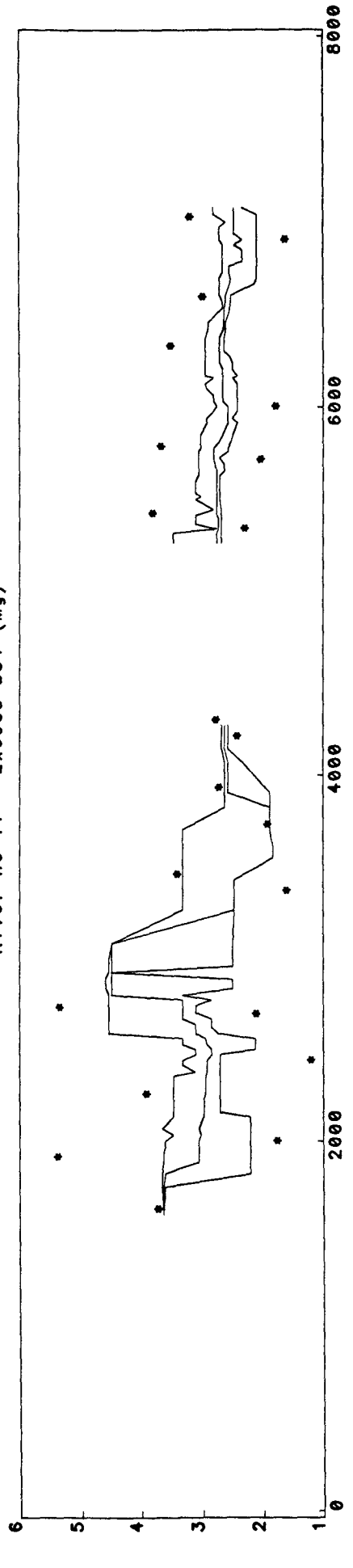

River no 12 Excess SO4 (Mg)

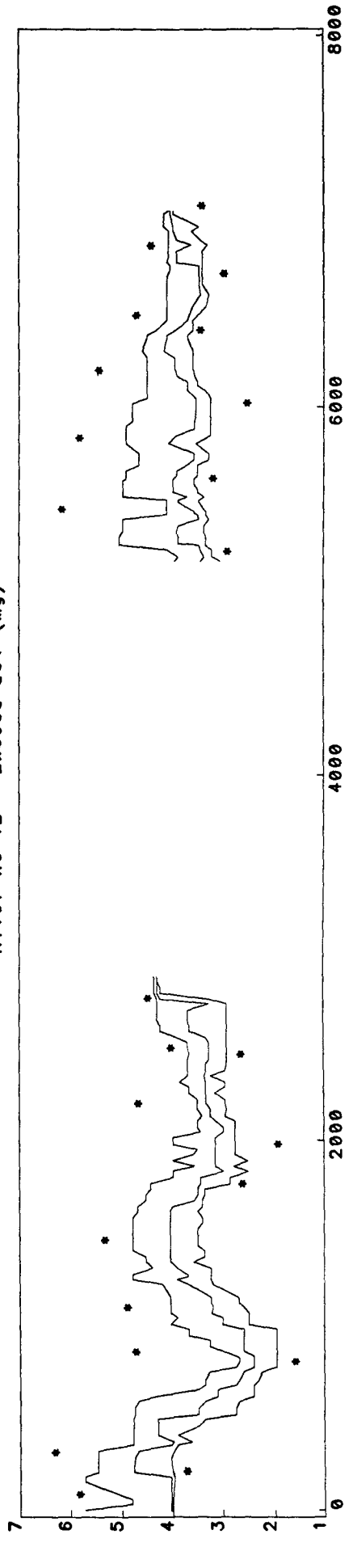

Julian Day

River no 13 Excess S04 (Mg)

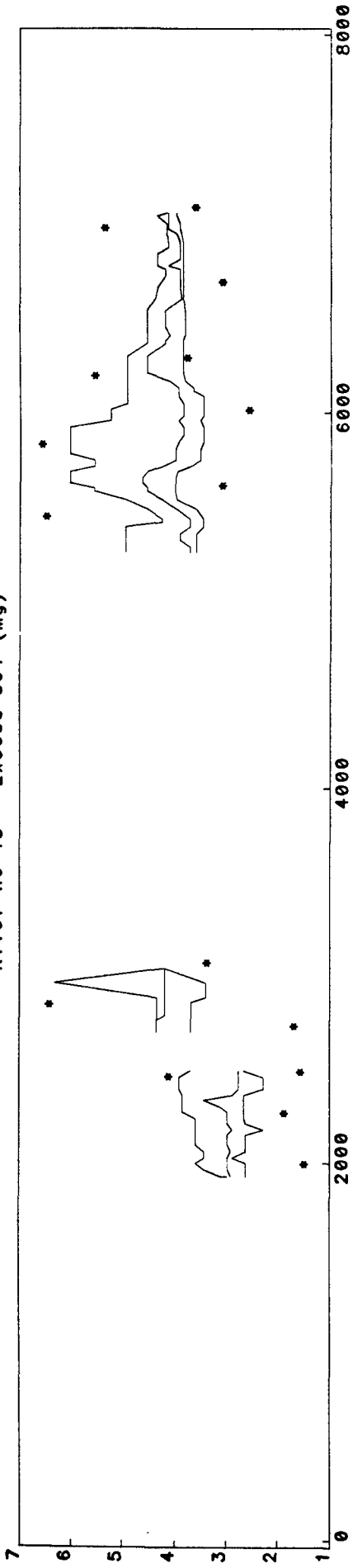

River no 16 Excess S04 (Mg)

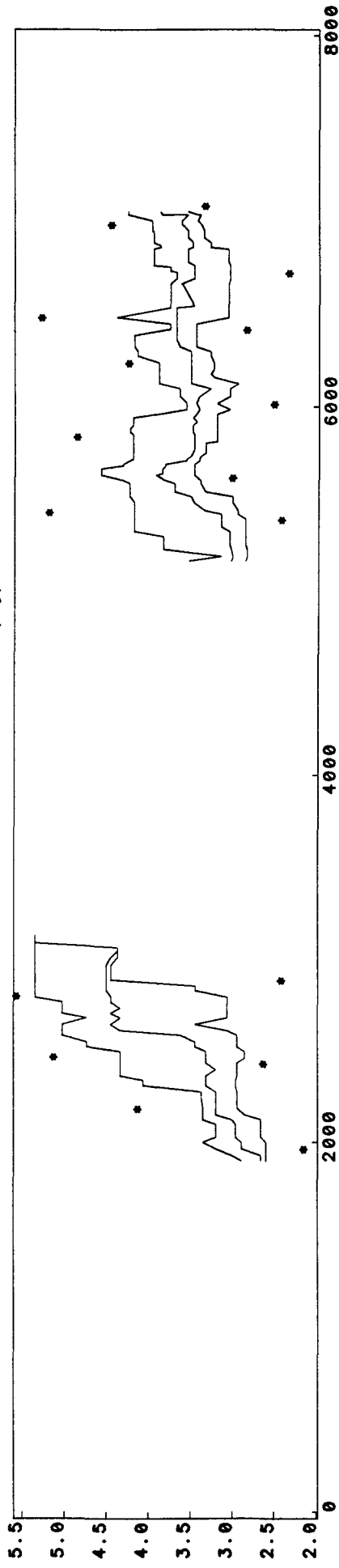

River no 17 Excess S04 (Mg)

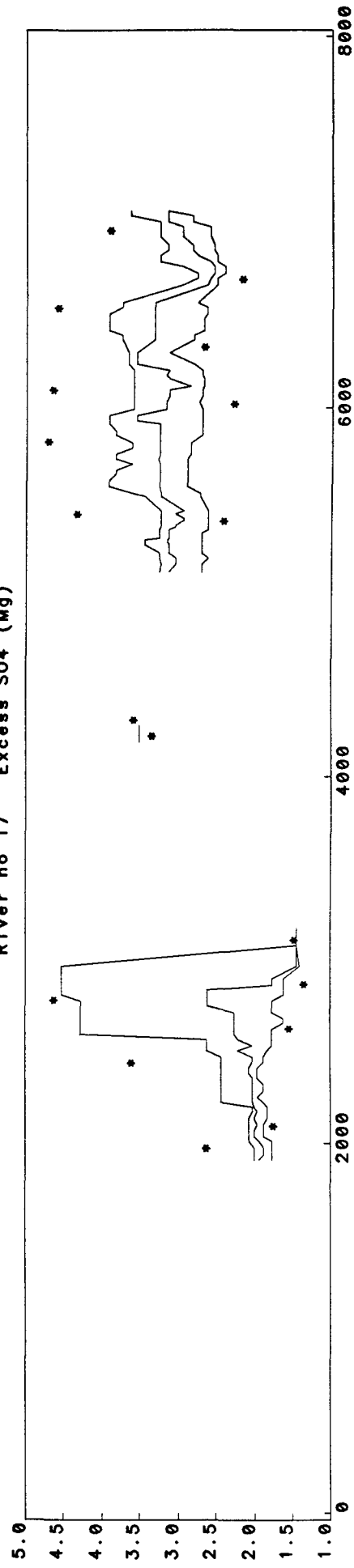

River no 18 Excess SO4 (Mg)

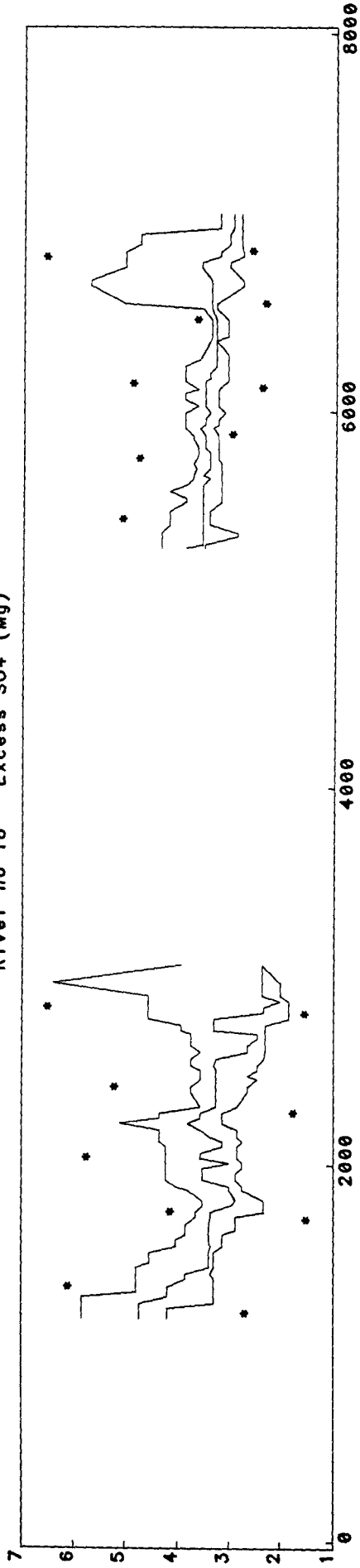

River no 19 Excess SO4 (Mg)

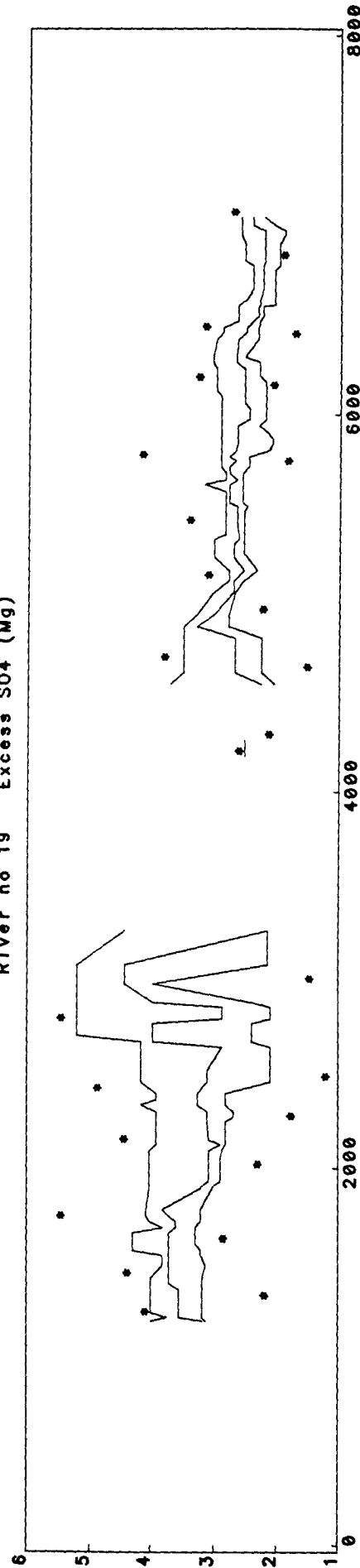

River no 20 Excess SO4 (Mg)

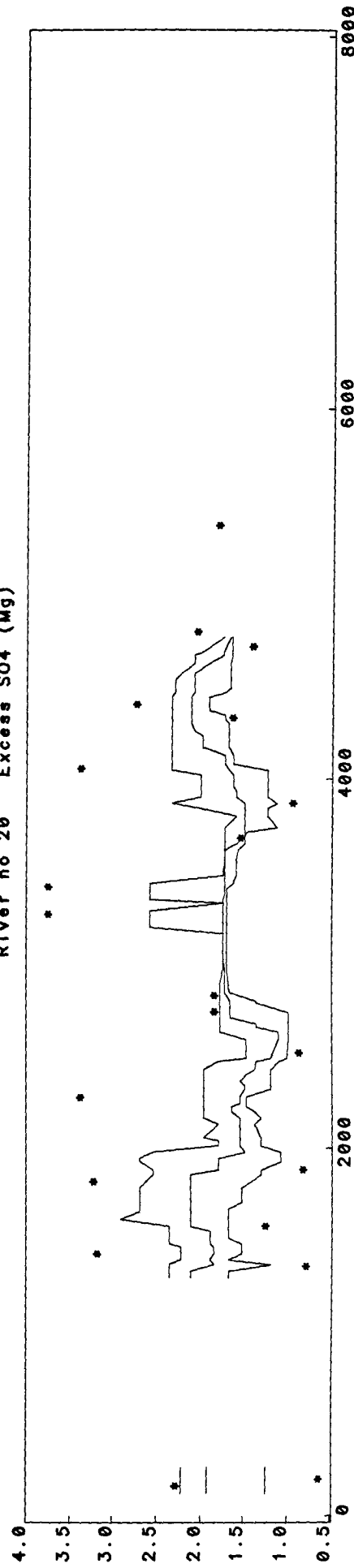

River no 21 Excess S04 (Mg)

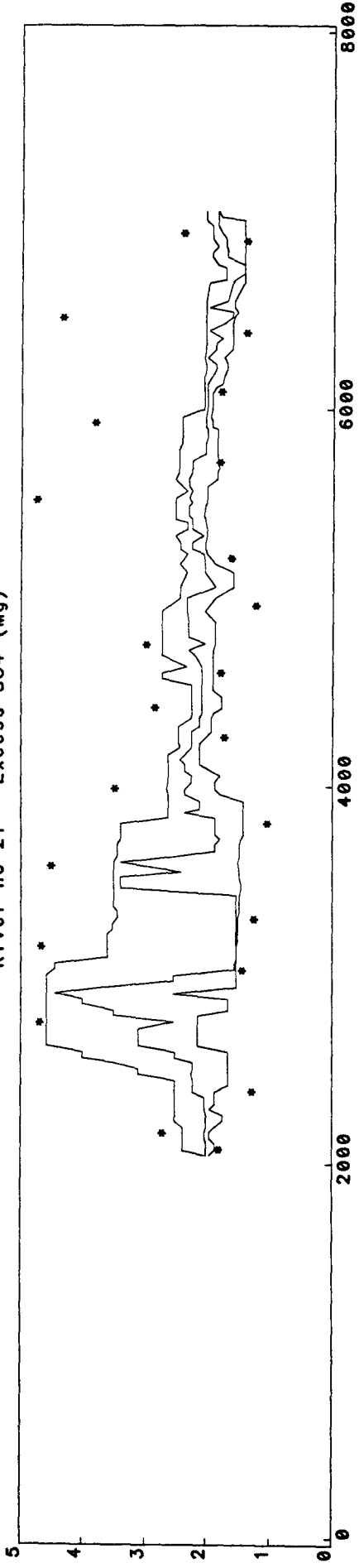

River no 22 Excess S04 (Mg)

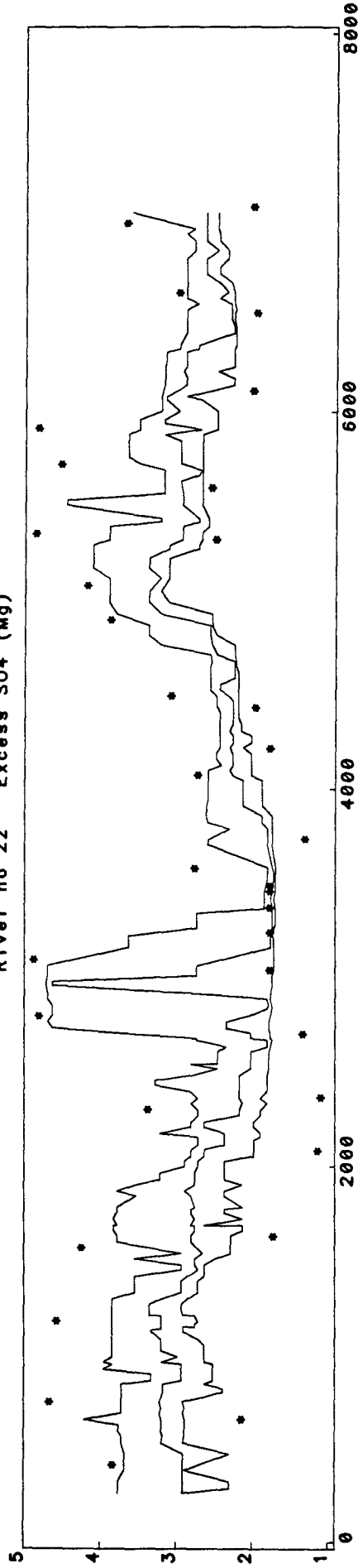

River no 23 Excess S04 (Mg)

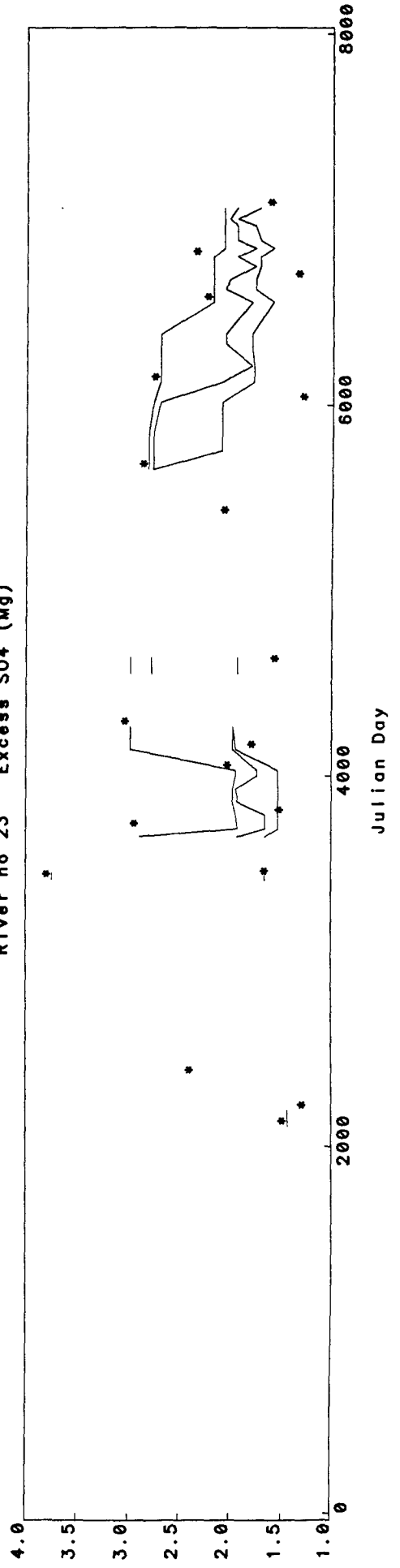

River no 25 Excess SO4 (Mg)

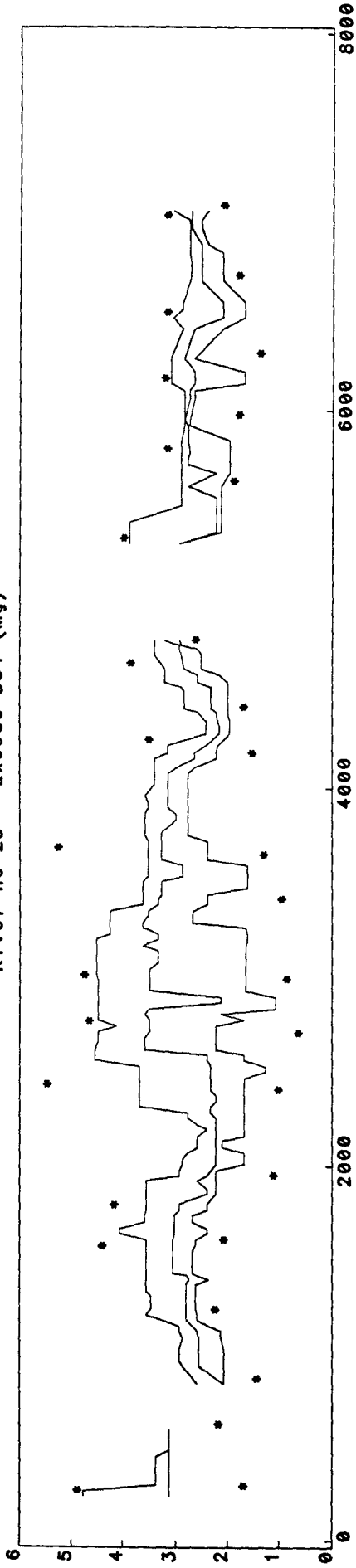

River no 26 Excess SO4 (Mg)

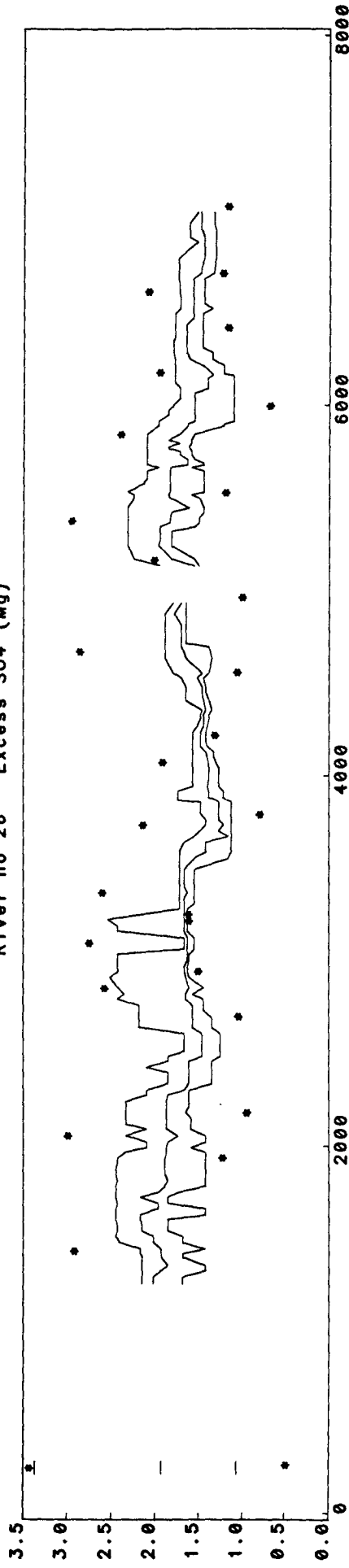

River no 27 Excess SO4 (Mg)

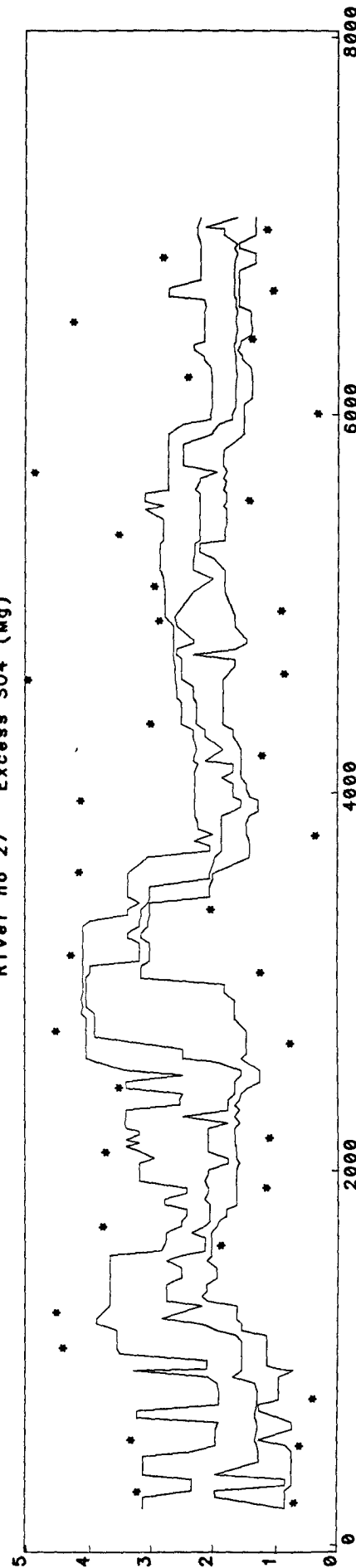

River no 28 Excess S04 (Mg)

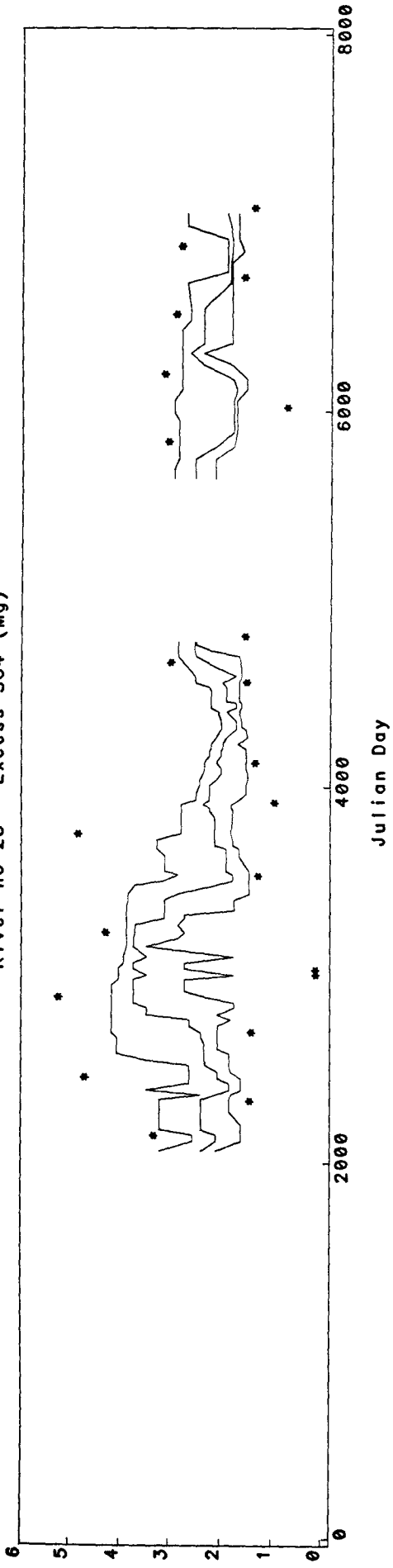



River no 1 Excess SO4 (Mg) +/- 12 months

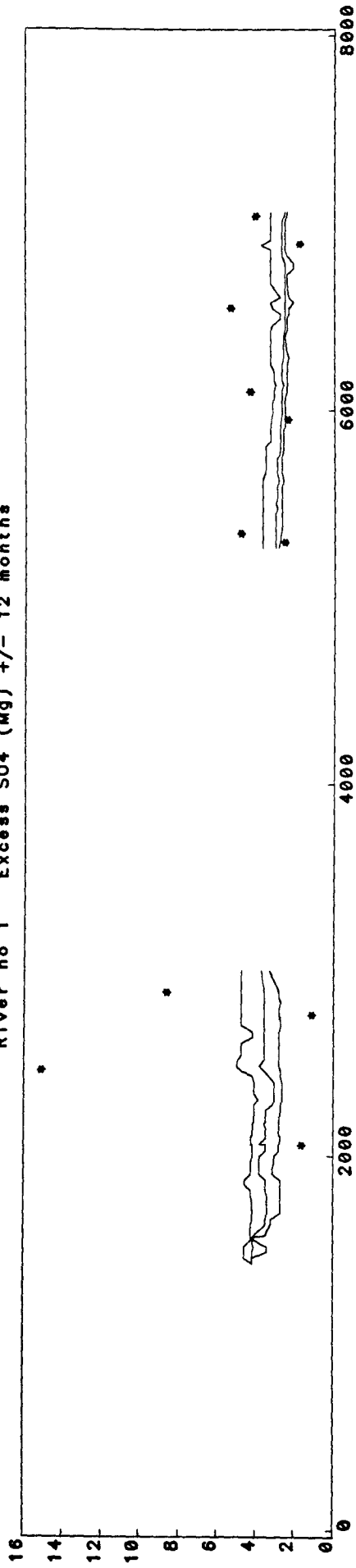

River no 2 Excess SO4 (Mg) +/- 12 months

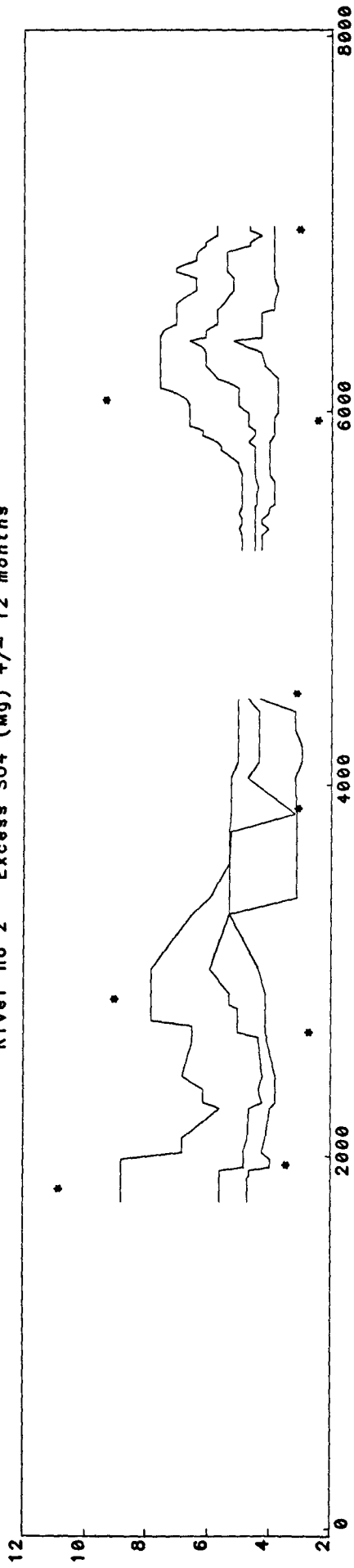

River no 3 Excess SO4 (Mg) +/- 12 months

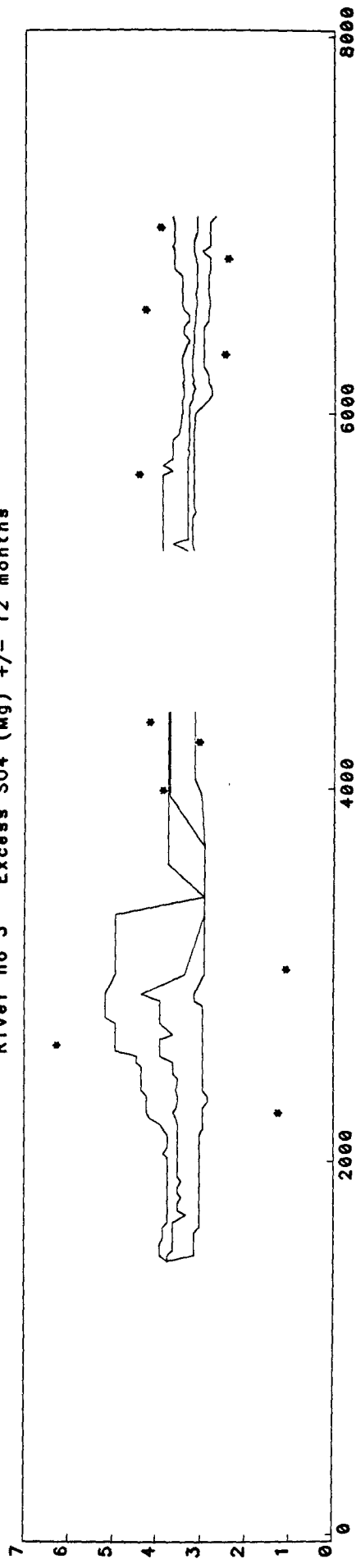

River no 4 Excess SO4 (Mg) +/- 12 months

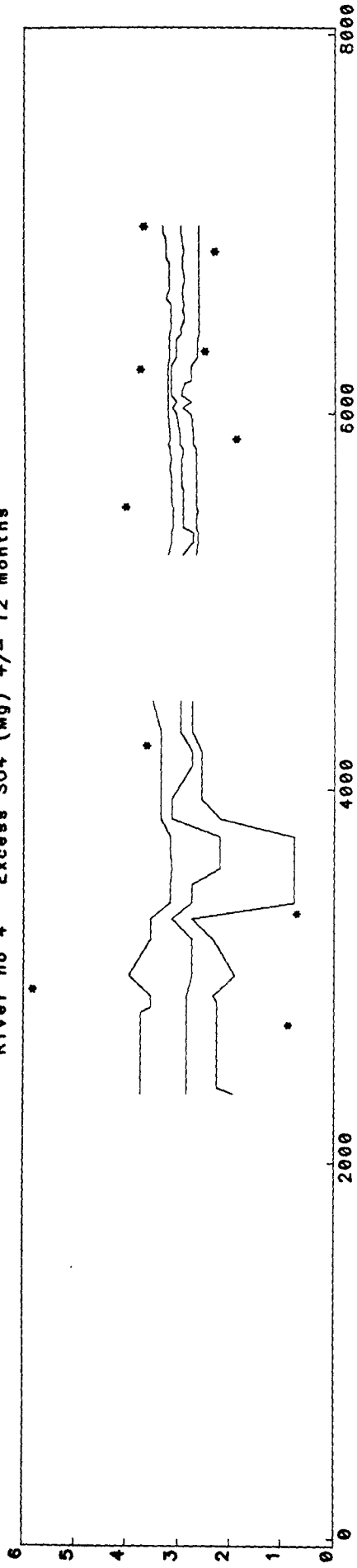

River no 5 Excess SO4 (Mg) +/- 12 months

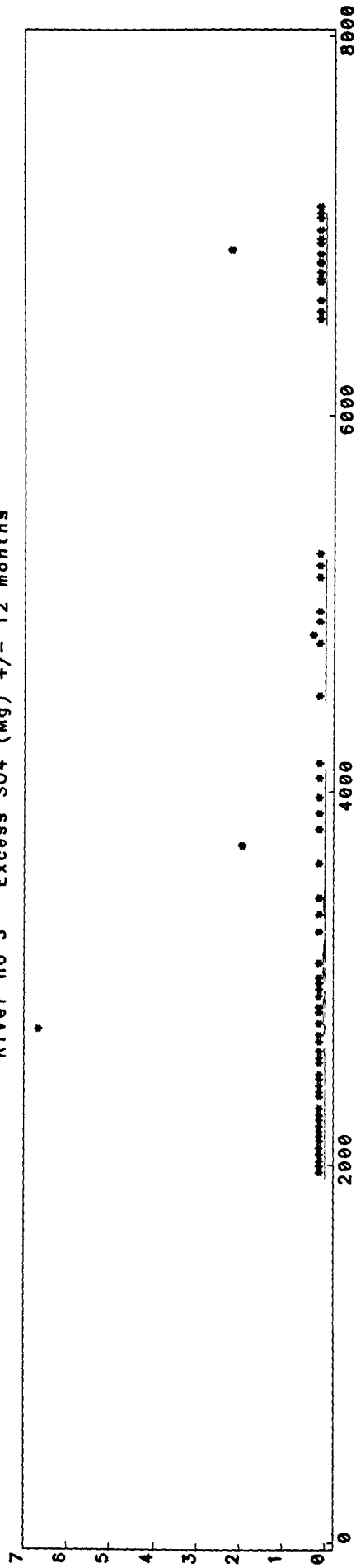

River no 6 Excess SO4 (Mg) +/- 12 months

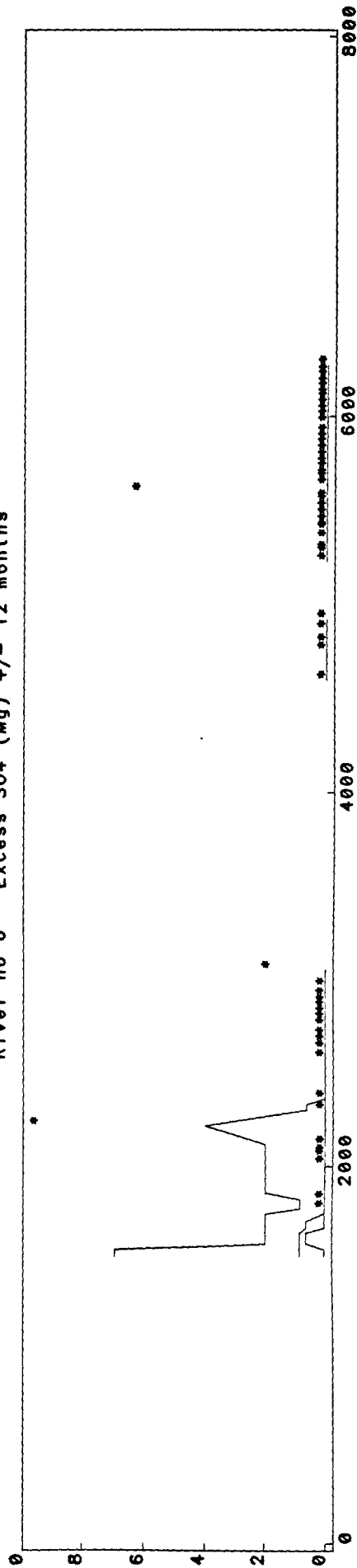

River no 7 Excess SO4 (Mg) +/- 12 months

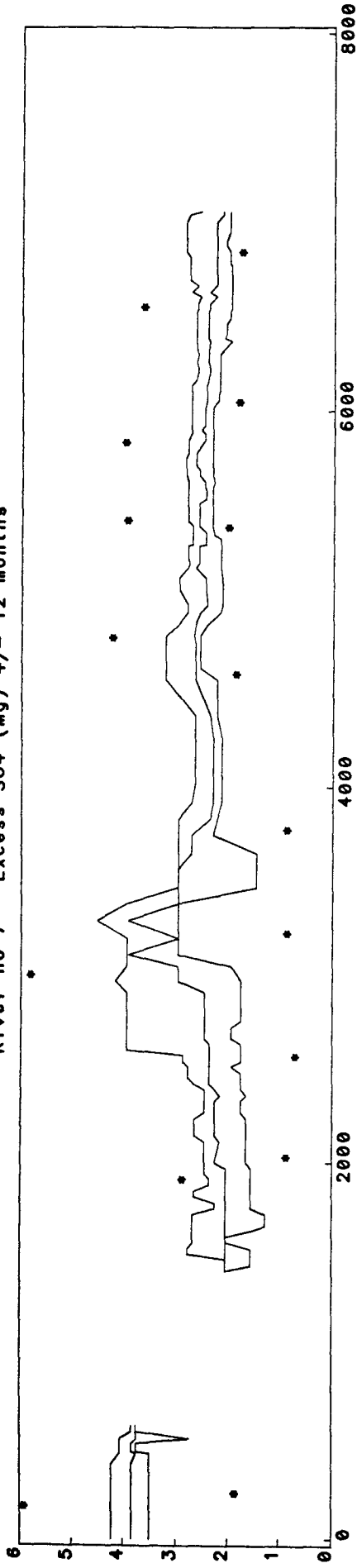

River no 8 Excess SO4 (Mg) +/- 12 months

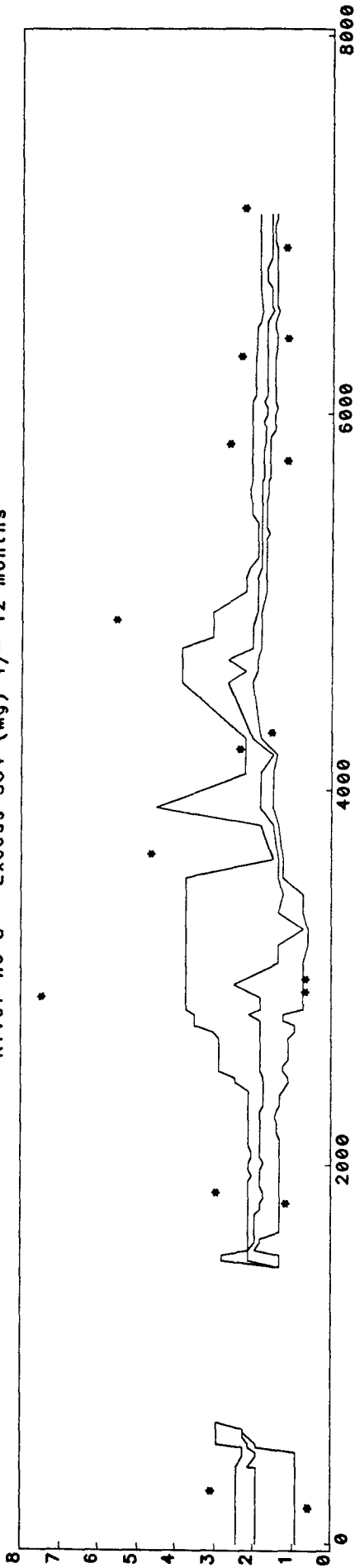

River no 9 Excess SO4 (Mg) +/- 12 months

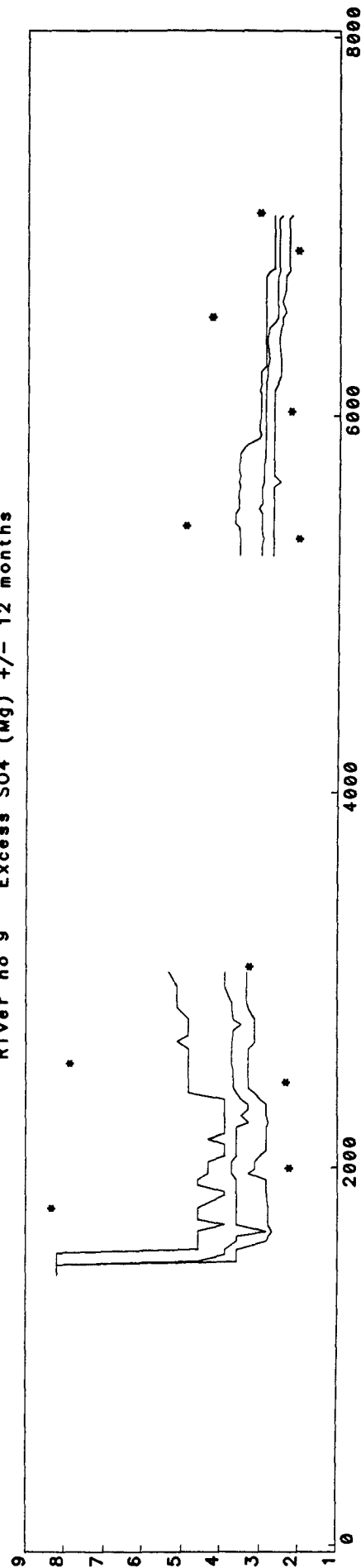

River no 10 Excess SO4 (Mg) +/- 12 months

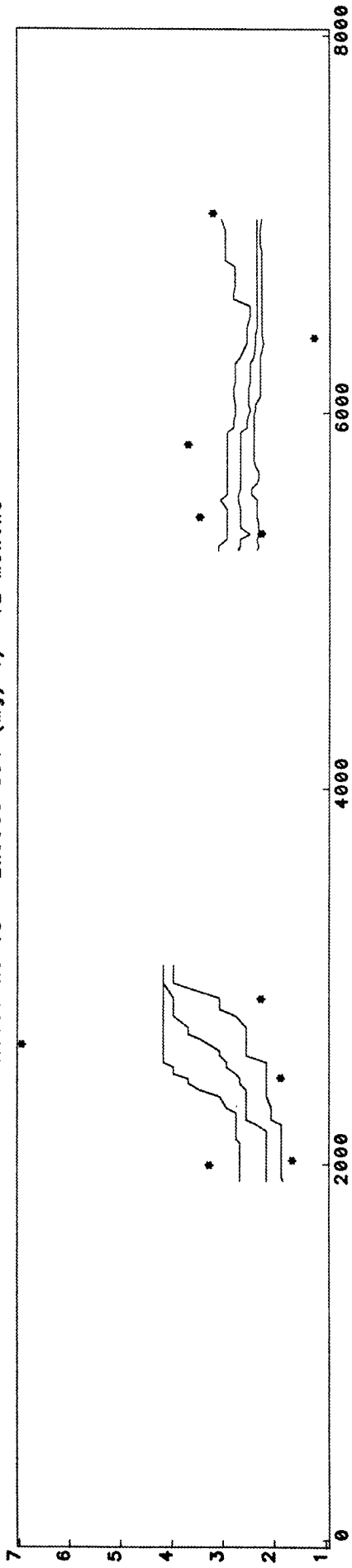

River no 11 Excess SO4 (Mg) +/- 12 months

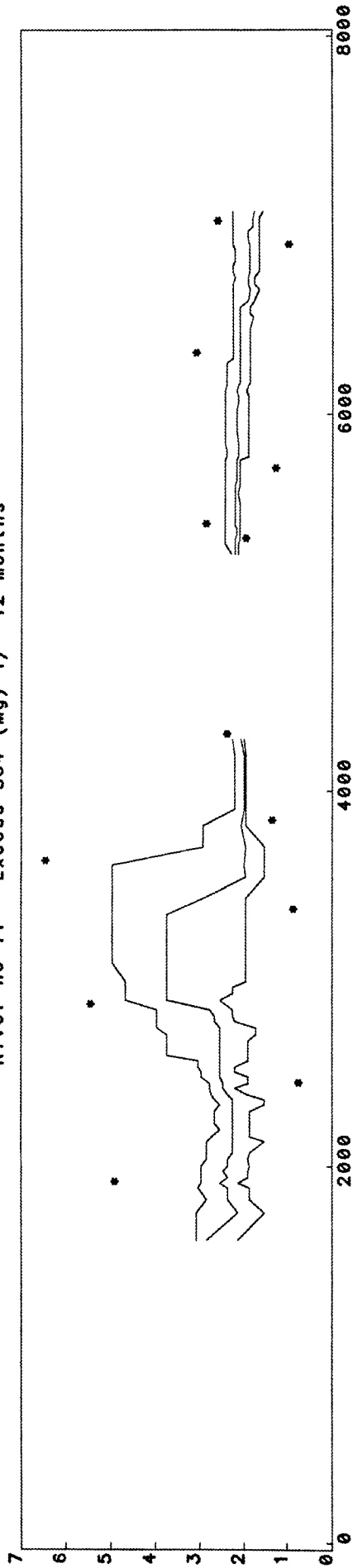

River no 12 Excess SO4 (Mg) +/- 12 months

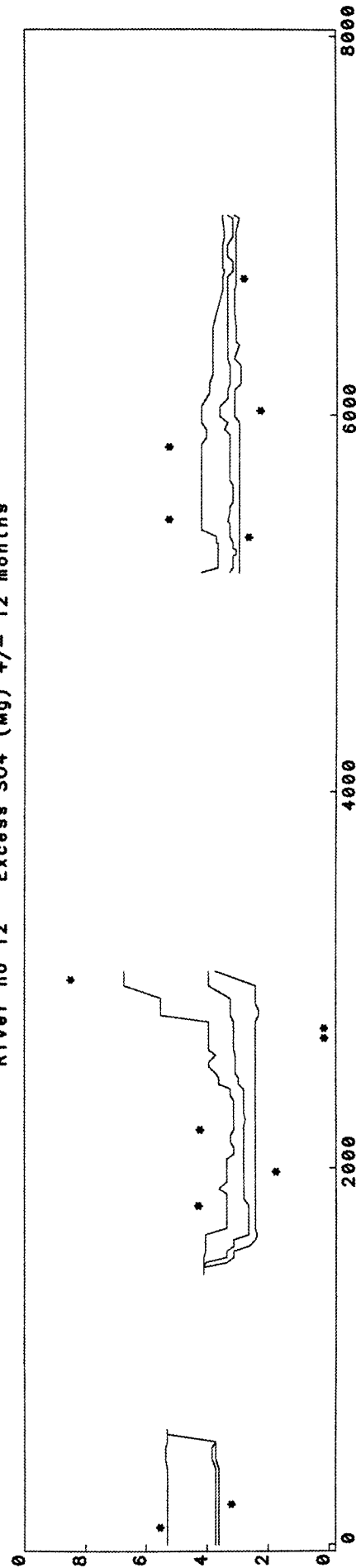

River no 13 Excess S04 (Mg) +/- 12 months

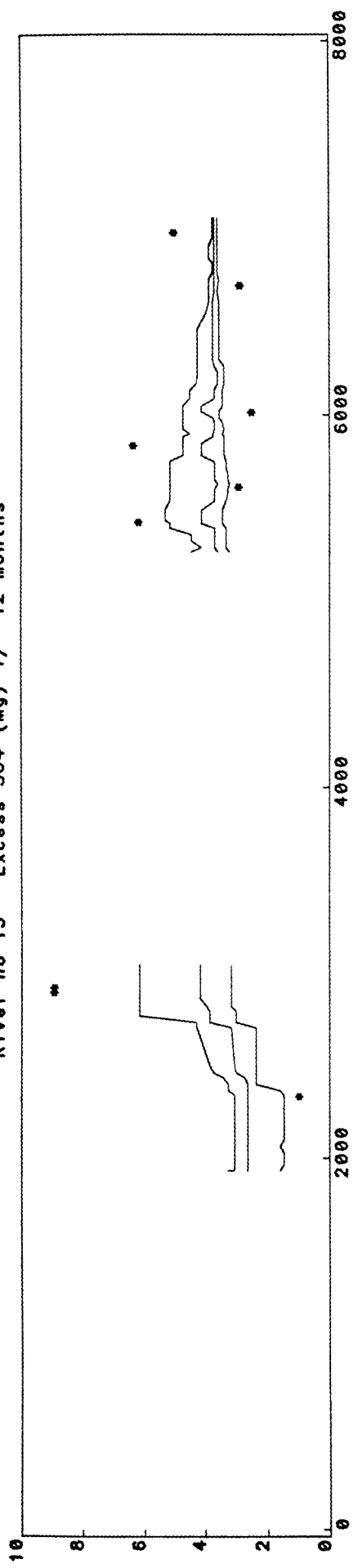

River no 16 Excess S04 (Mg) +/- 12 months

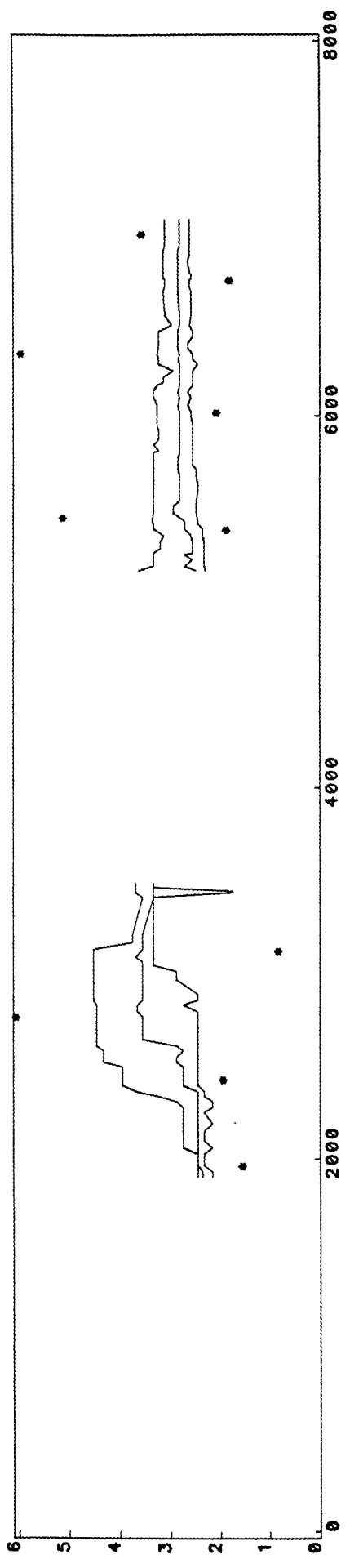

River no 17 Excess S04 (Mg) +/- 12 months

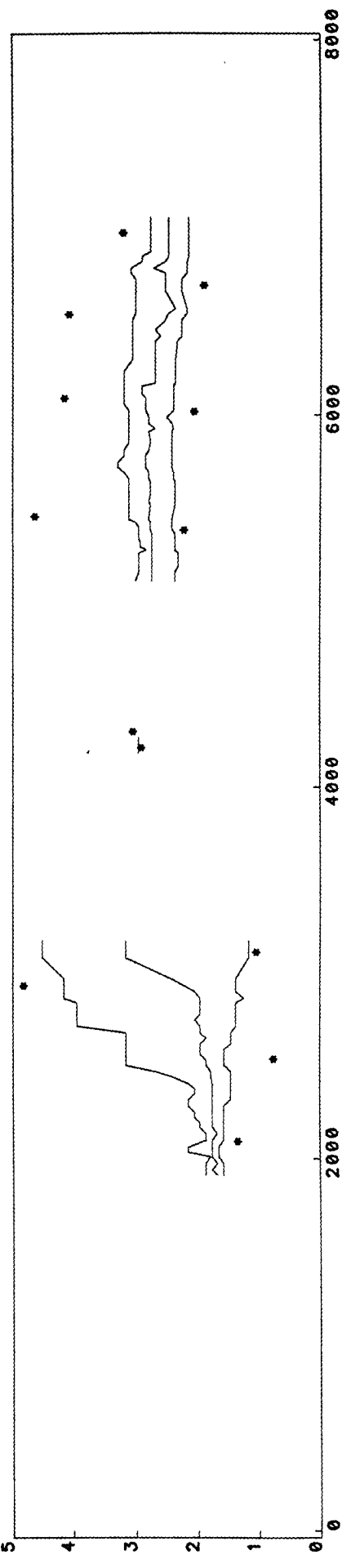

River no 18 Excess SO4 (Mg) +/- 12 months

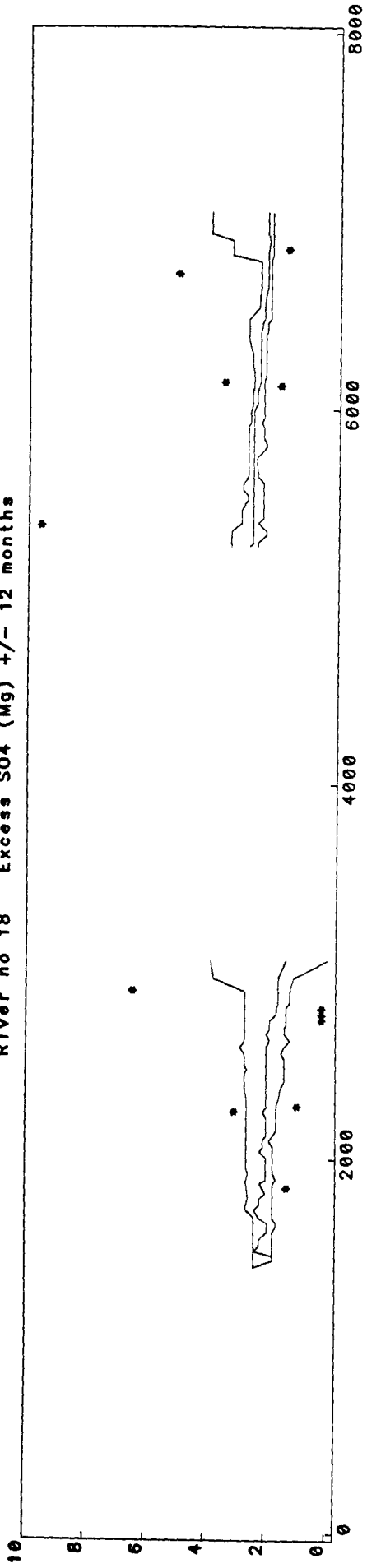

River no 19 Excess SO4 (Mg) +/- 12 months

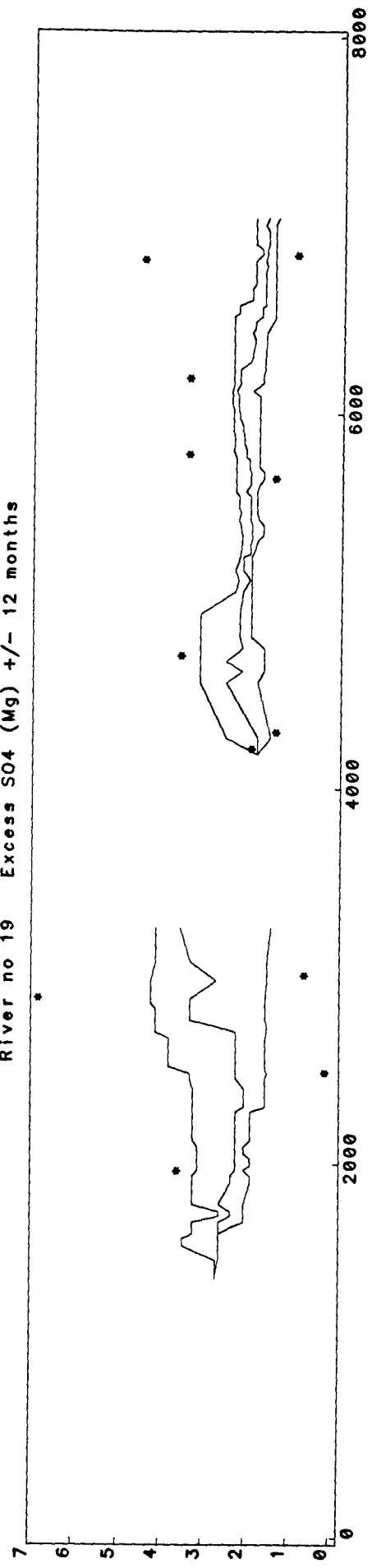

River no 20 Excess SO4 (Mg) +/- 12 months

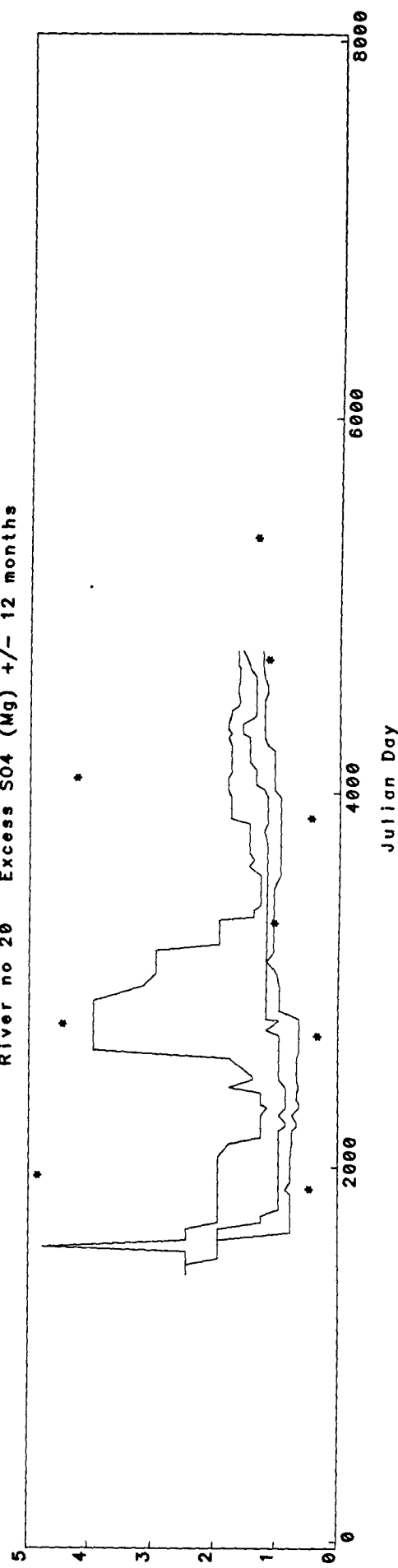

River no 21 Excess SO4 (Mg) +/- 12 months

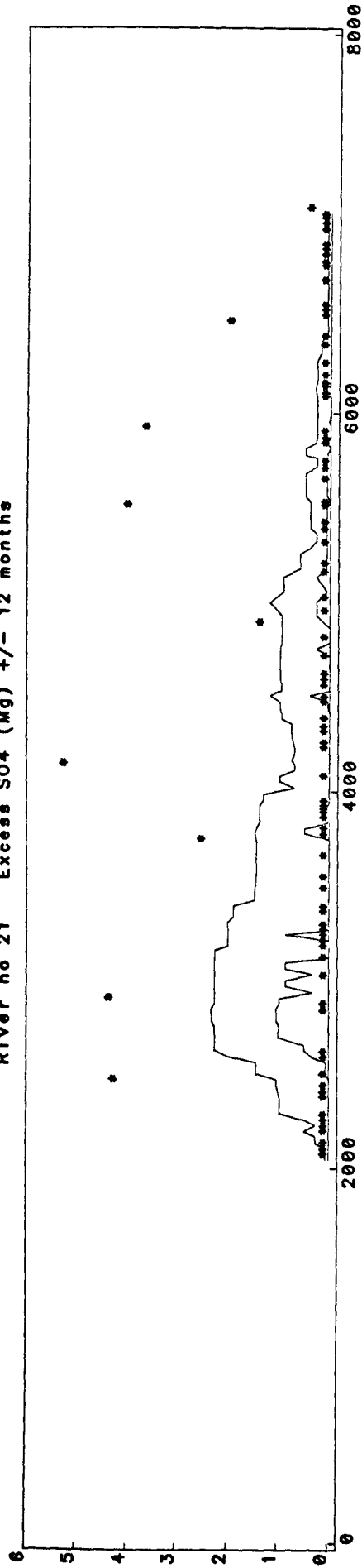

River no 22 Excess SO4 (Mg) +/- 12 months

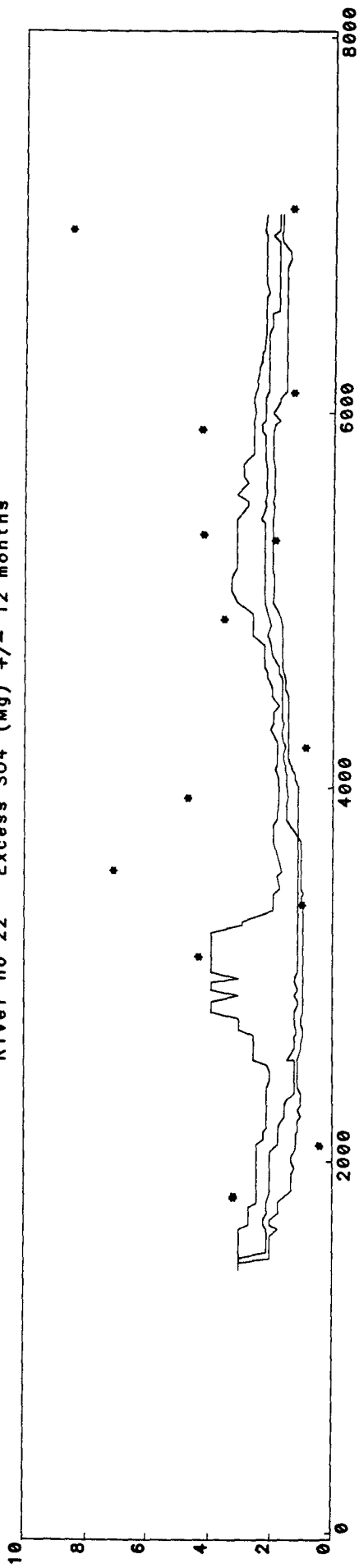

River no 23 Excess SO4 (Mg) +/- 12 months

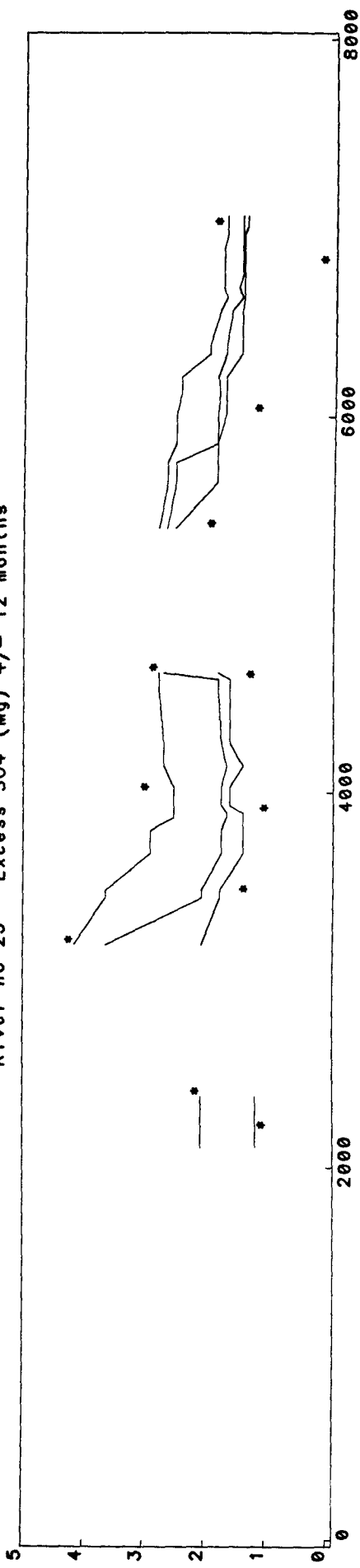

Appendix 11. Running boxplots of  $\text{NO}_3 + \text{NO}_2$  for the study rivers.



River no 1  
Nox (Nitrates etc)

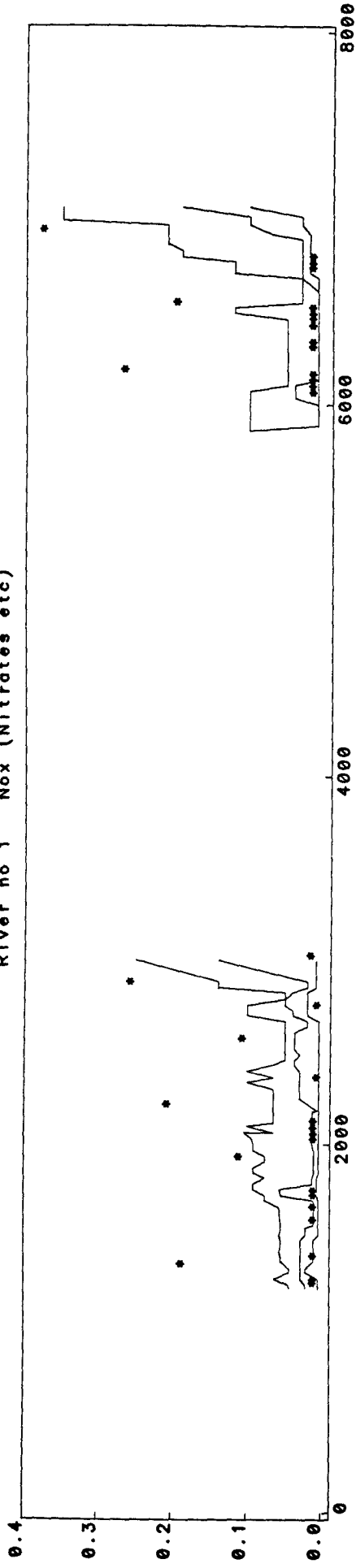

River no 2  
Nox (Nitrates etc)

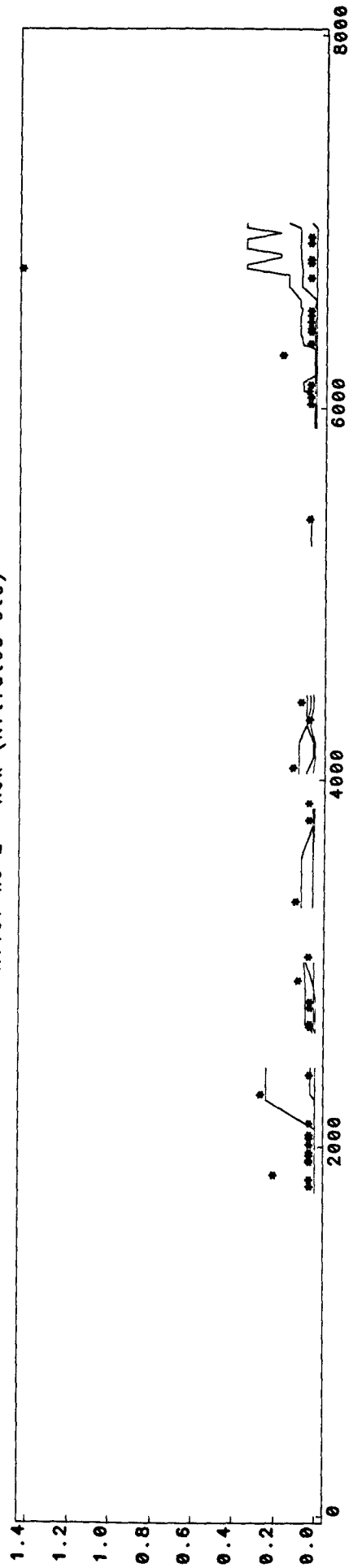

River no 3  
Nox (Nitrates etc)

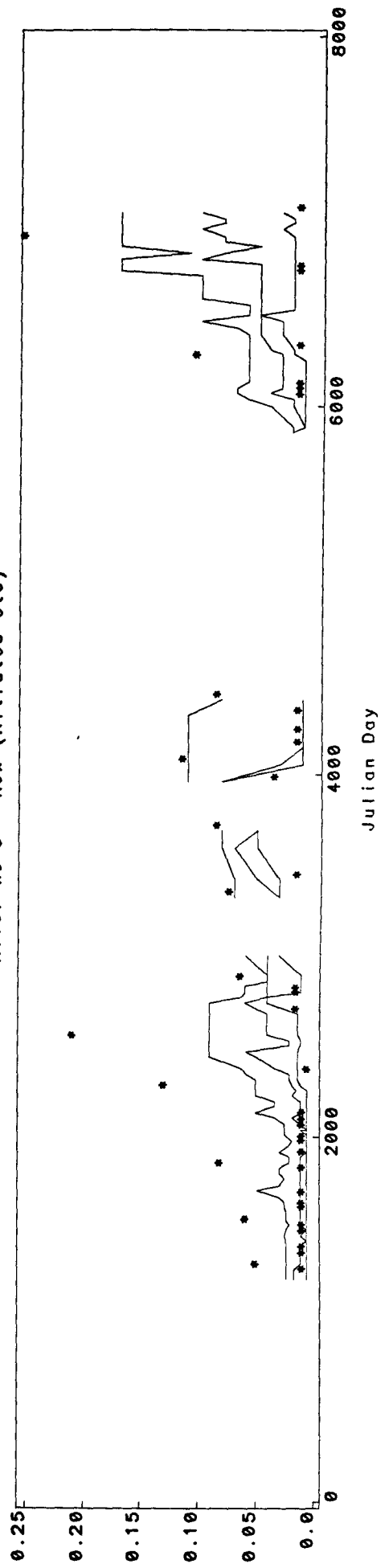

River no 4 Nox (Nitrates etc)

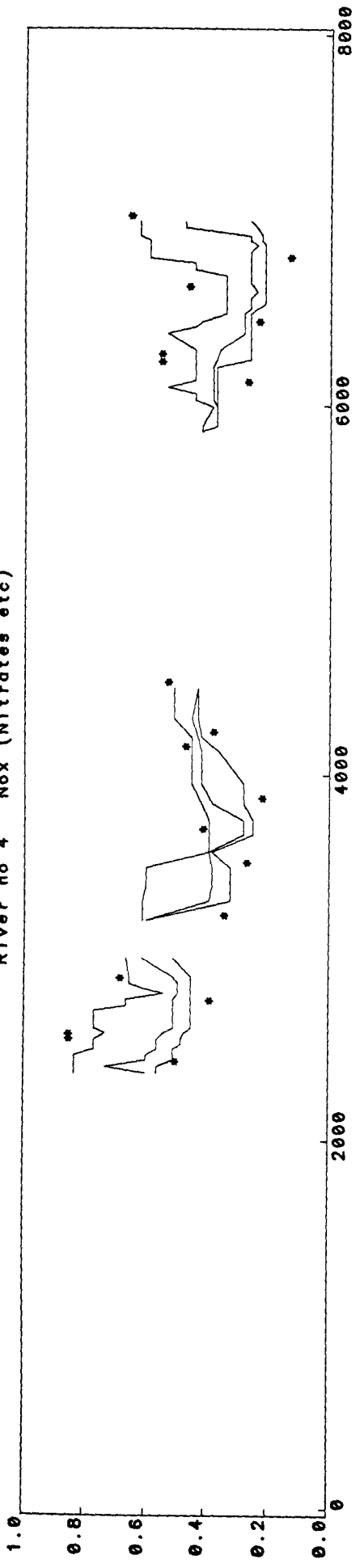

River no 5 Nox (Nitrates etc)

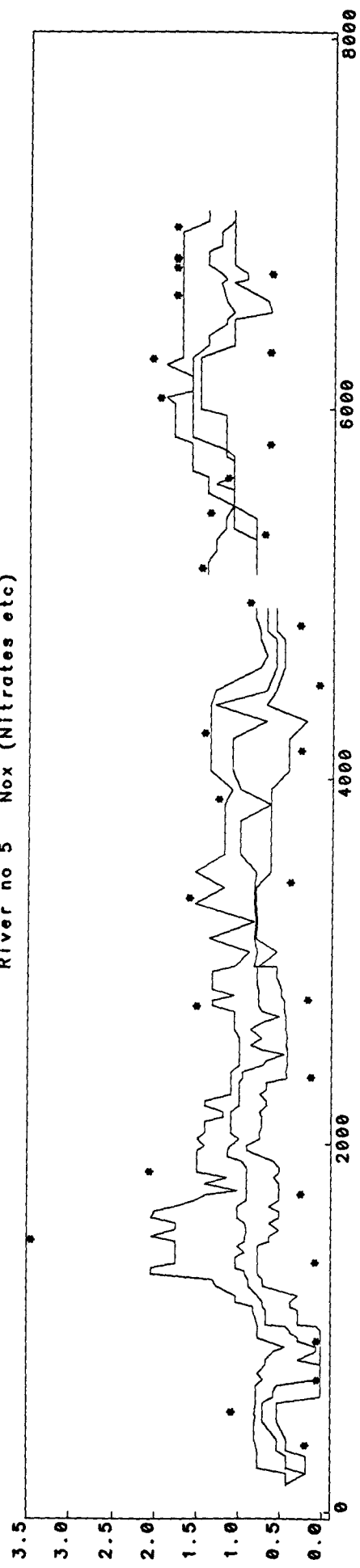

River no 6 Nox (Nitrates etc)

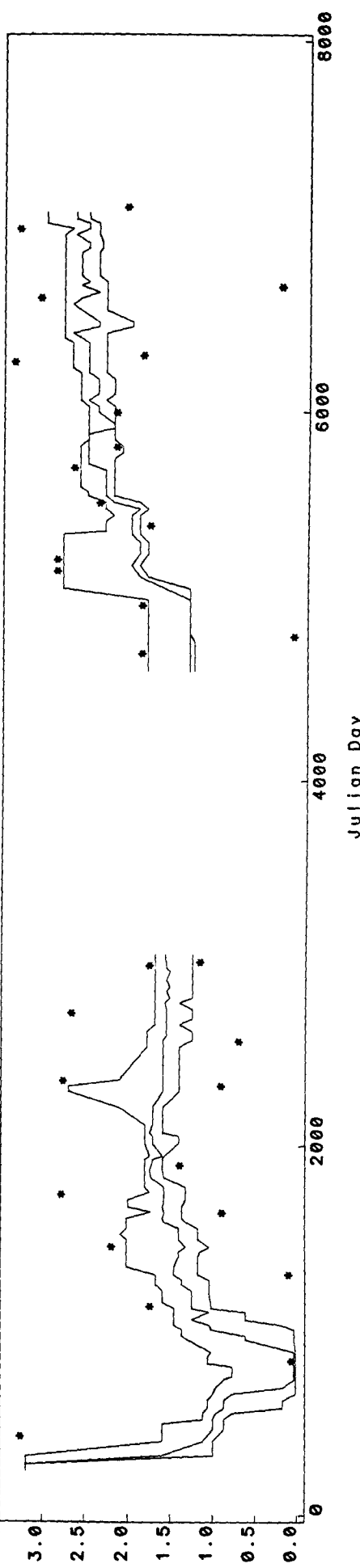

River no 7  
Nox (Nitrates etc)

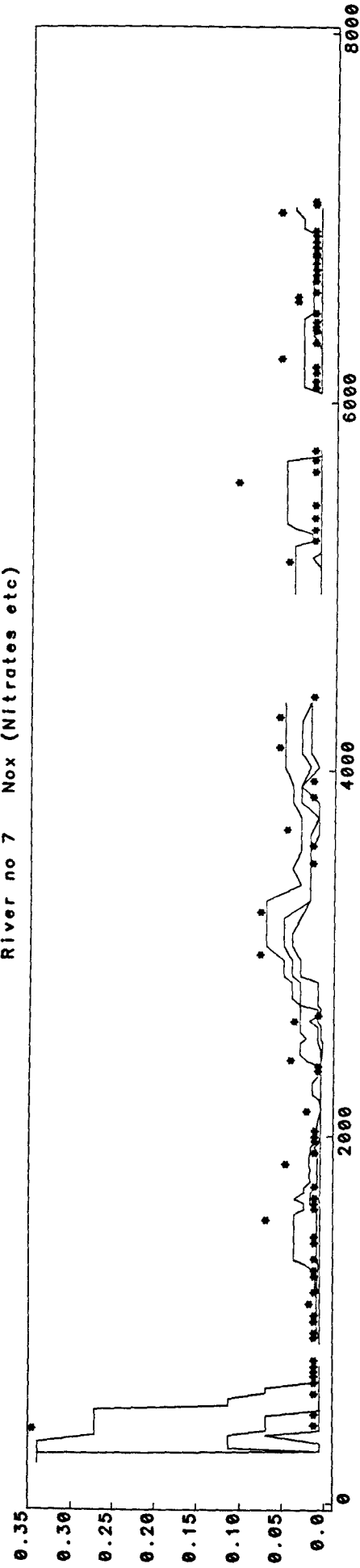

River no 8  
Nox (Nitrates etc)

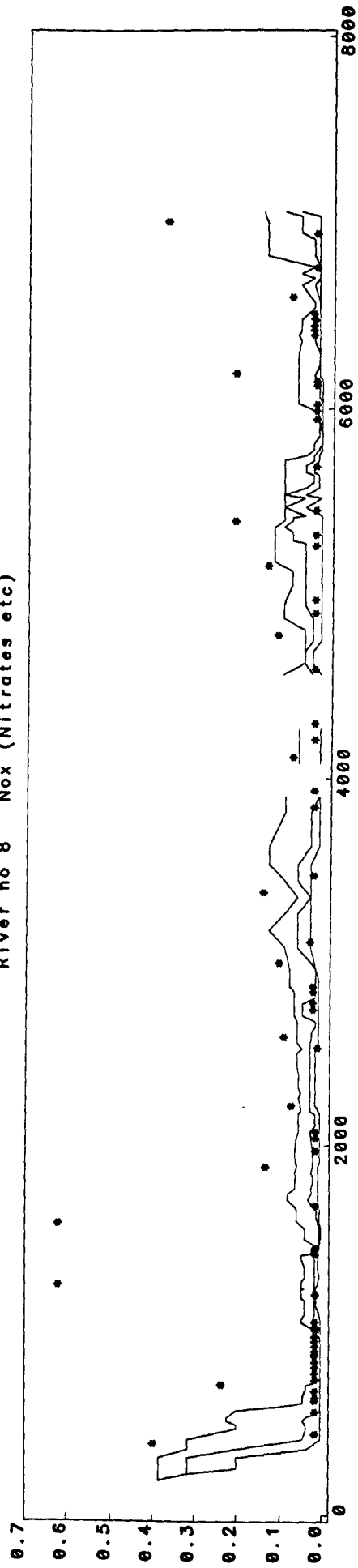

River no 9  
Nox (Nitrates etc)

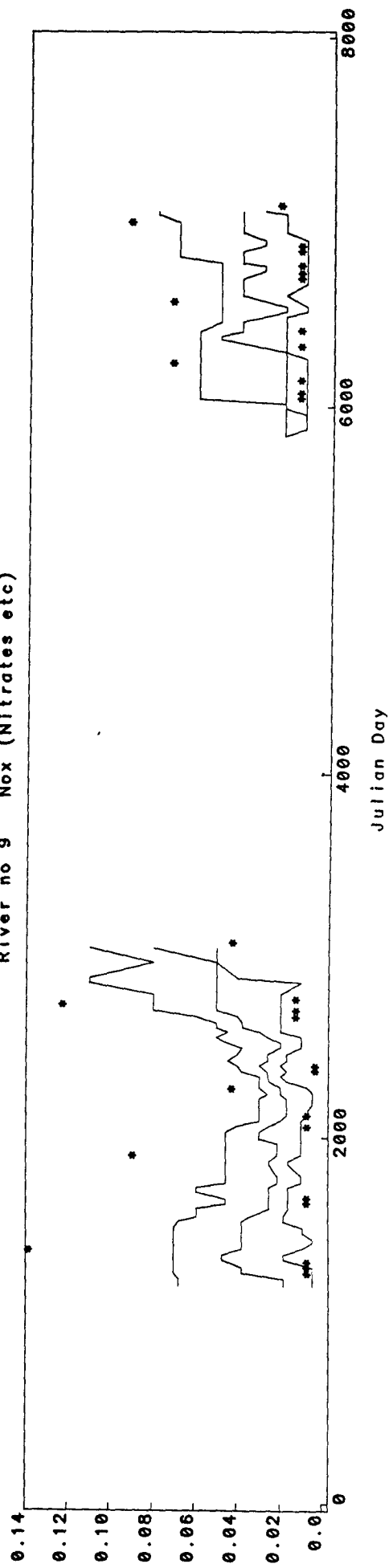

River no 10 Nox (Nitrates etc)

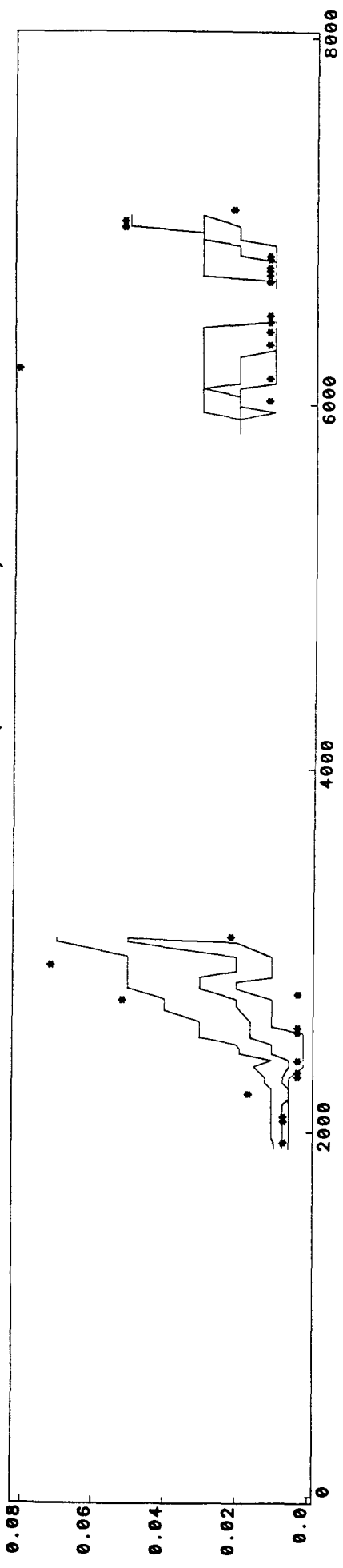

River no 11 Nox (Nitrates etc)

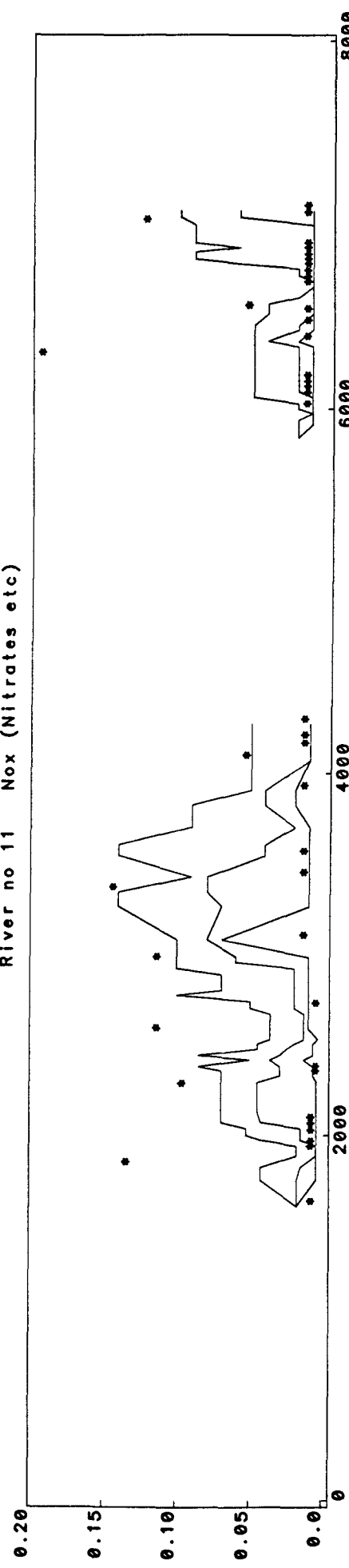

River no 12 Nox (Nitrates etc)

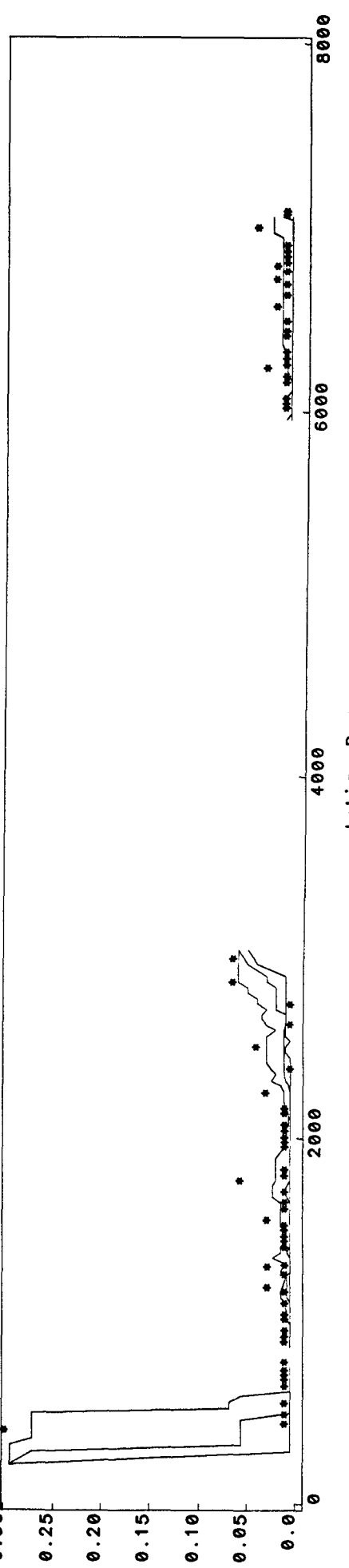

River no 13 Nox (Nitrates etc)

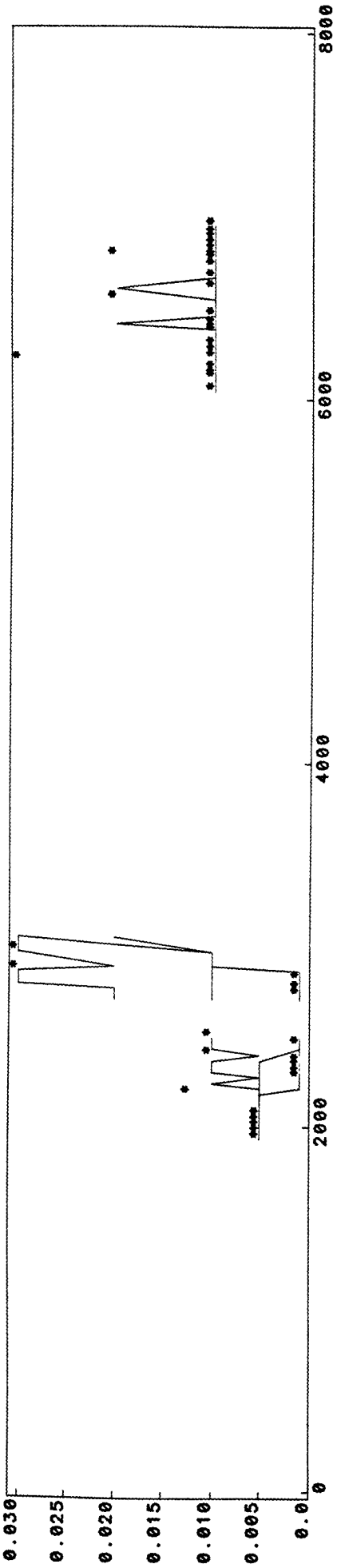

River no 16 Nox (Nitrates etc)

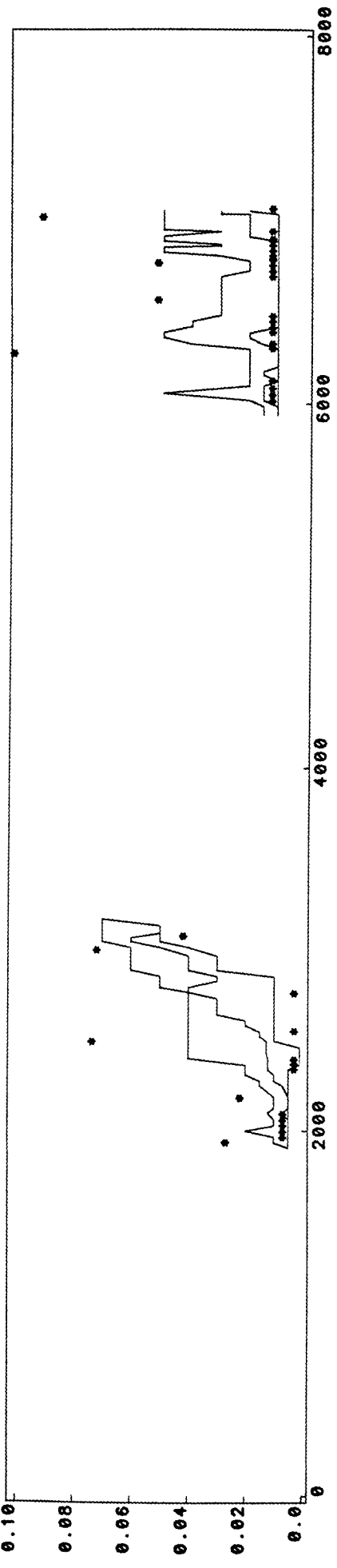

River no 17 Nox (Nitrates etc)

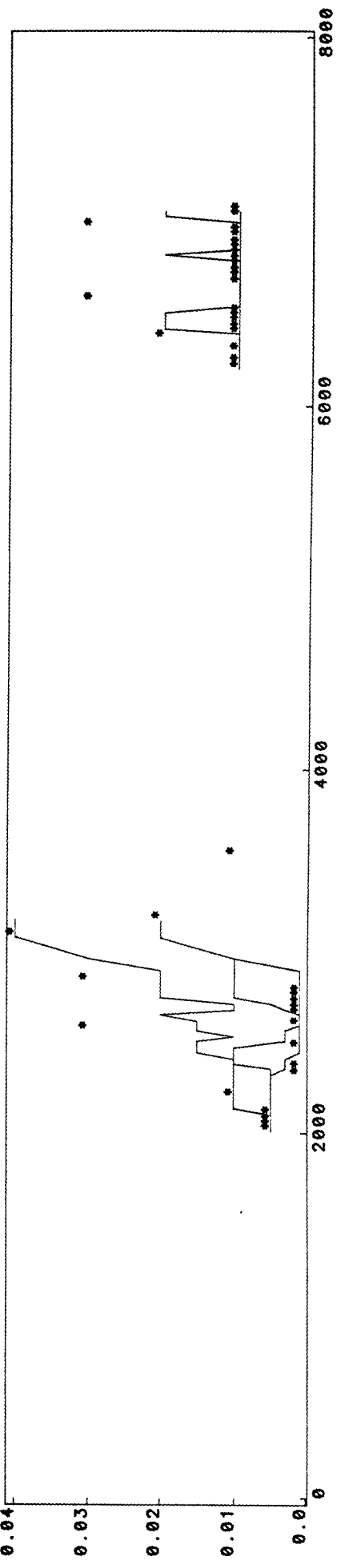

River no 18 Nox (Nitrates etc)

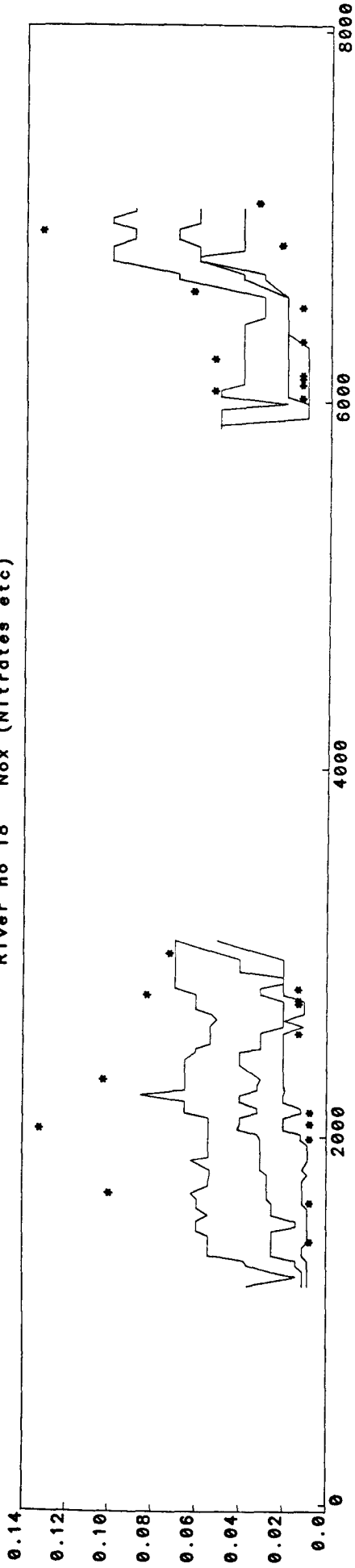

River no 19 Nox (Nitrates etc)

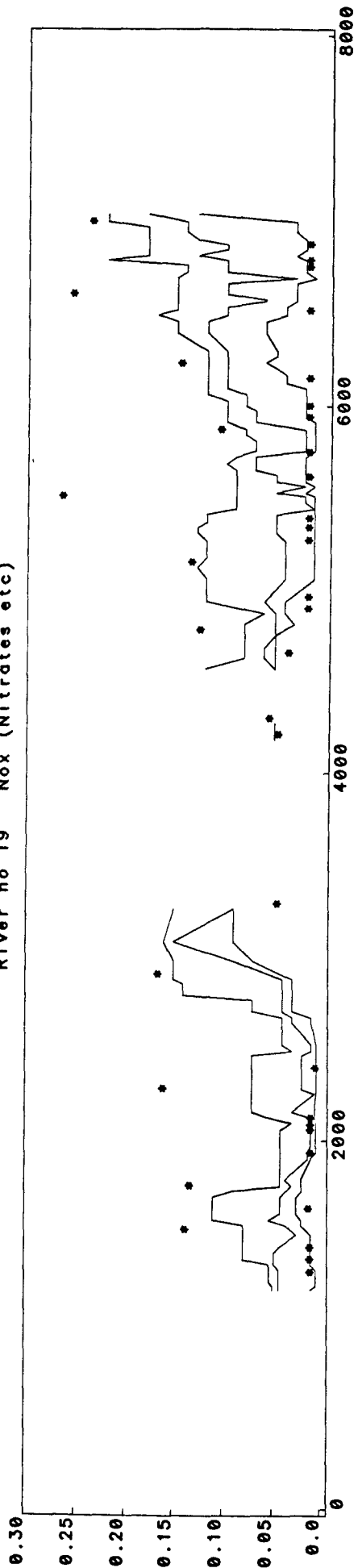

River no 20 Nox (Nitrates etc)

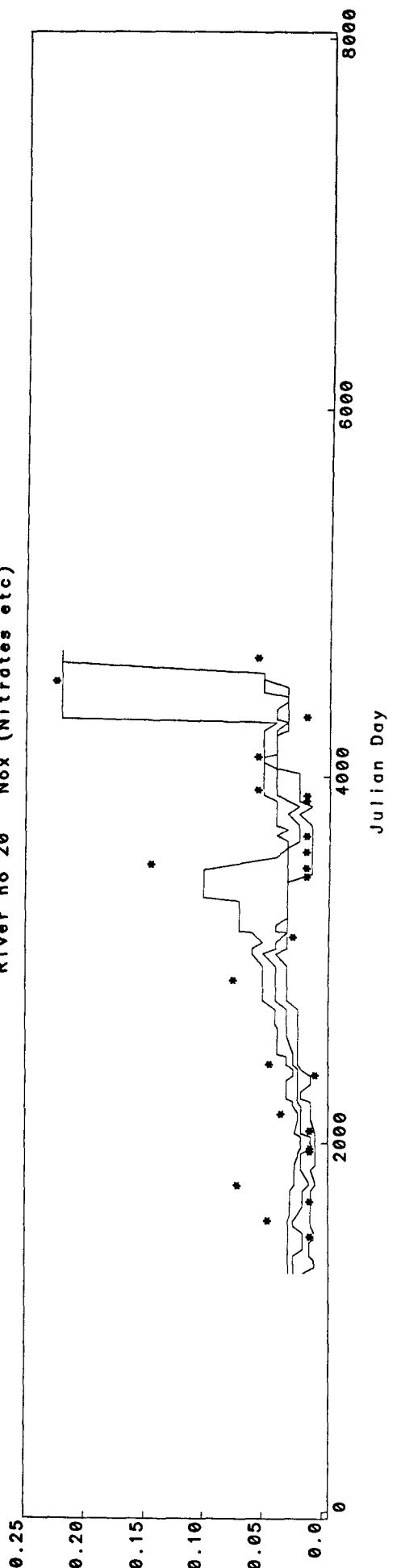

River no 21  
Nox (Nitrates etc)

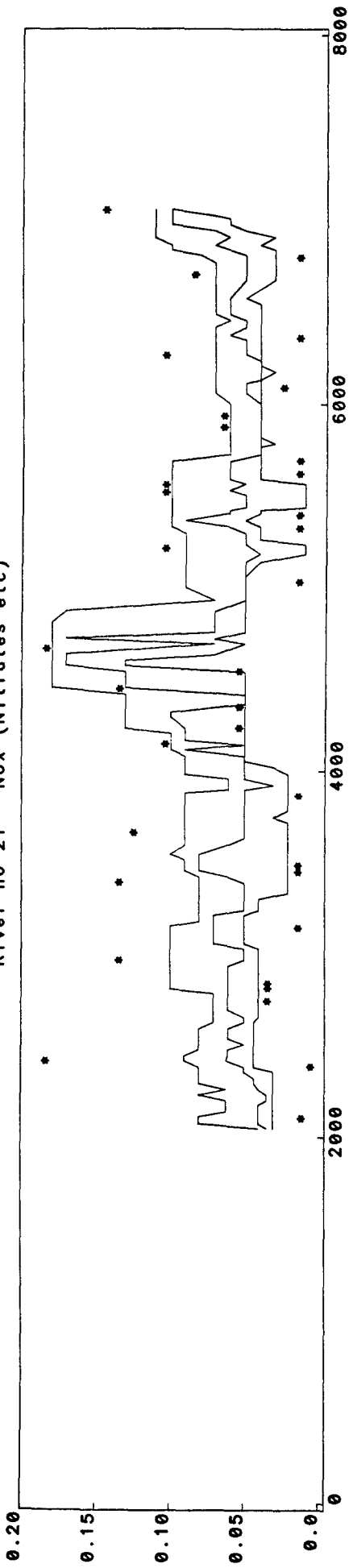

River no 22  
Nox (Nitrates etc)

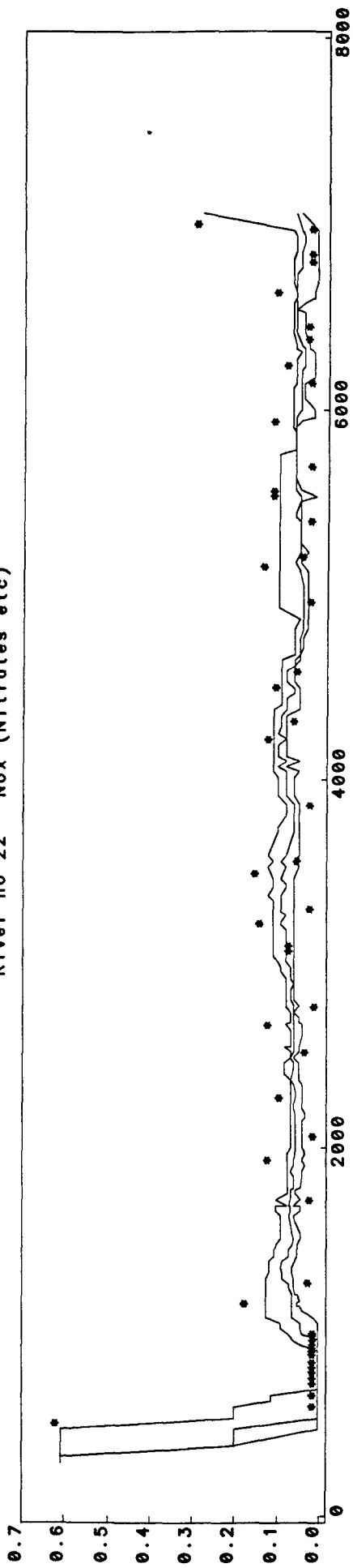

River no 23  
Nox (Nitrates etc)

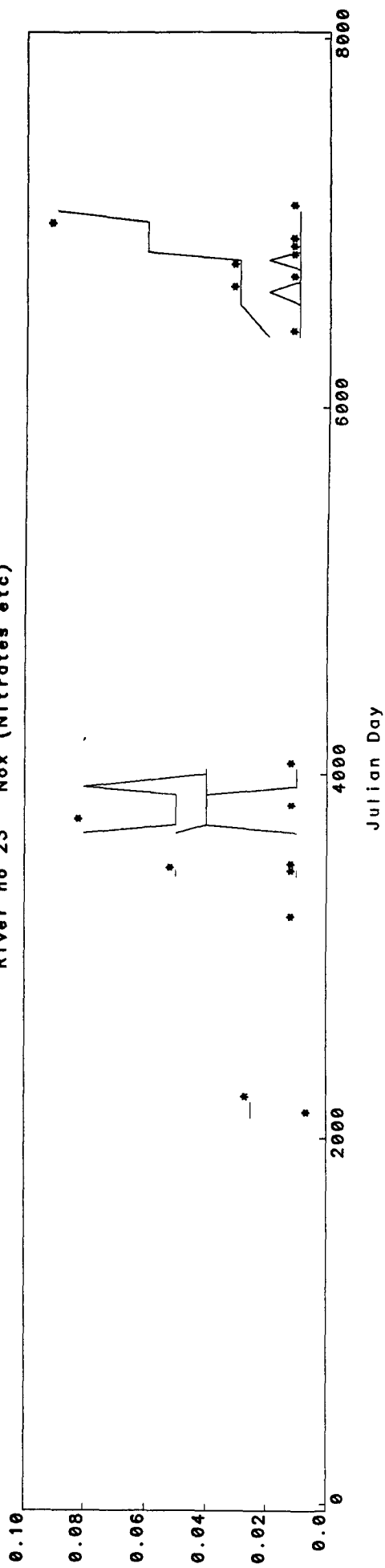

River no 25 Nox (Nitrates etc)

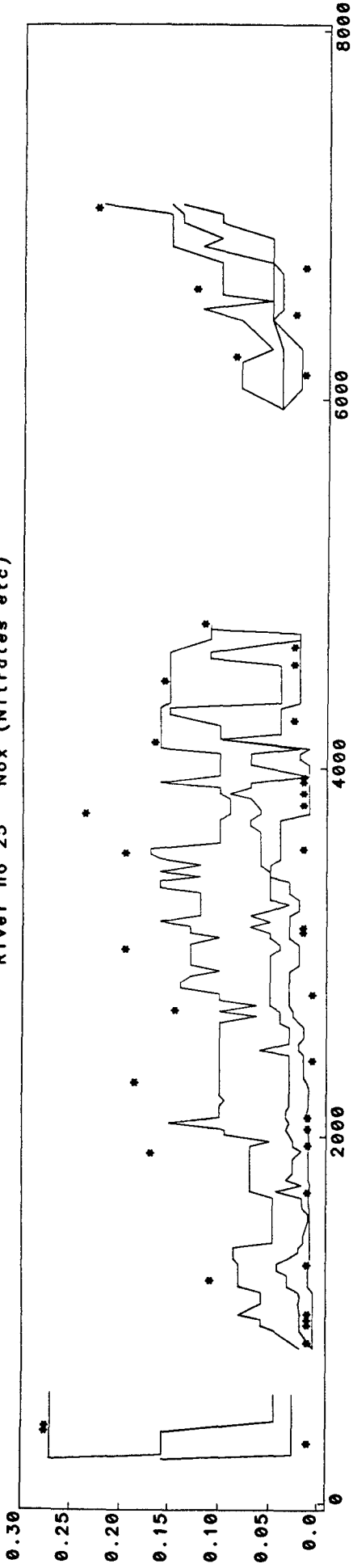

River no 26 Nox (Nitrates etc)

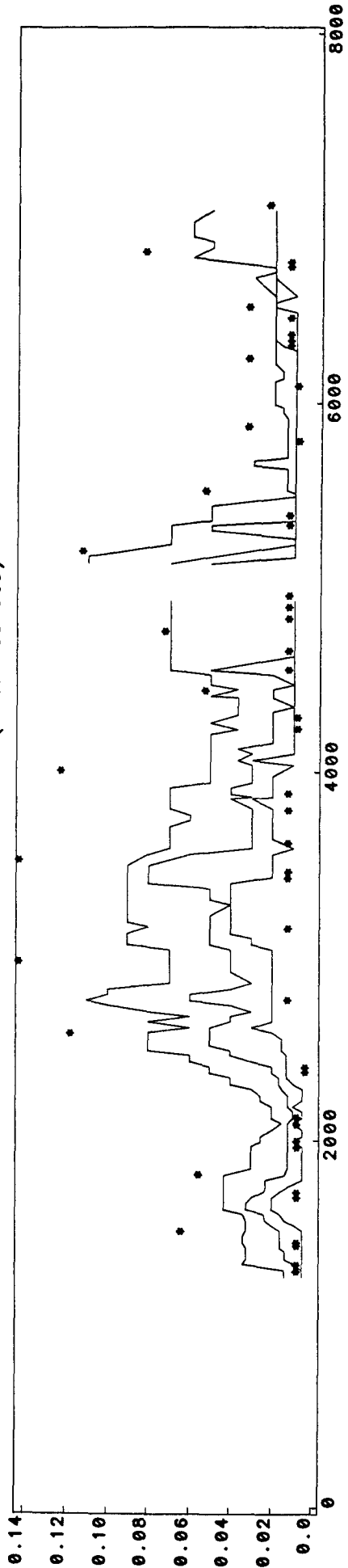

River no 27 Nox (Nitrates etc)

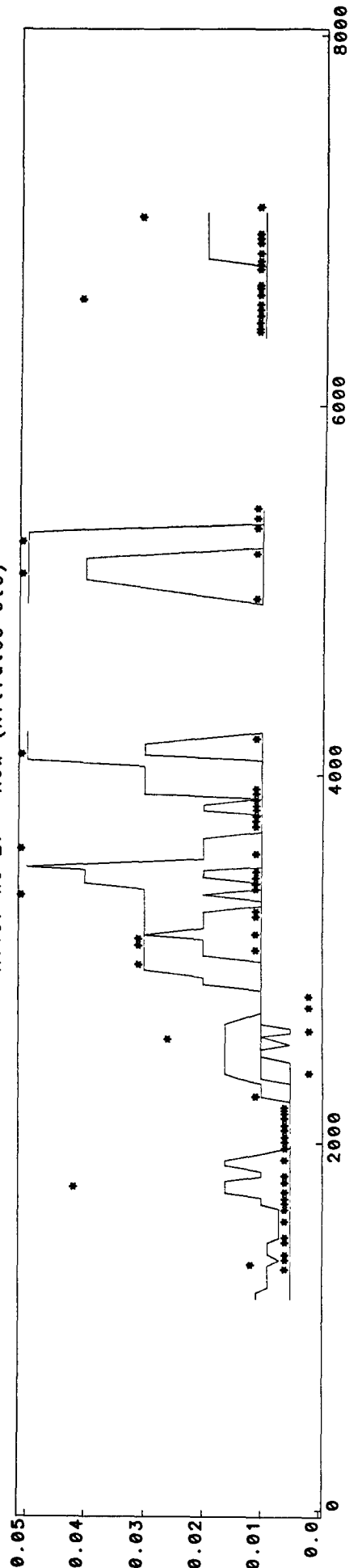

Julian Day



River no 28 Nox (Nitrates etc)

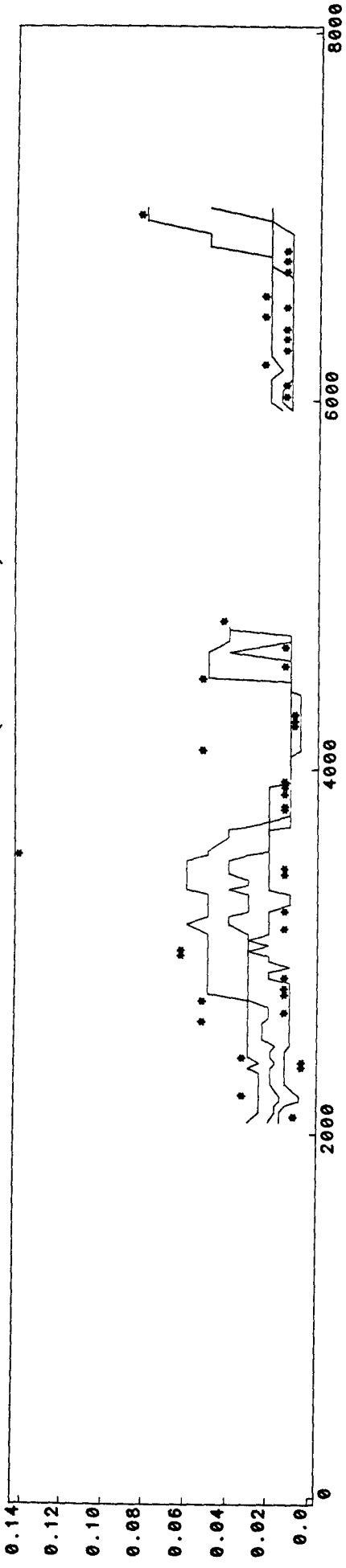

Julian Day

Appendix 12. Running boxplots of calcium for the study rivers.

River no 1 Ca (calcium)

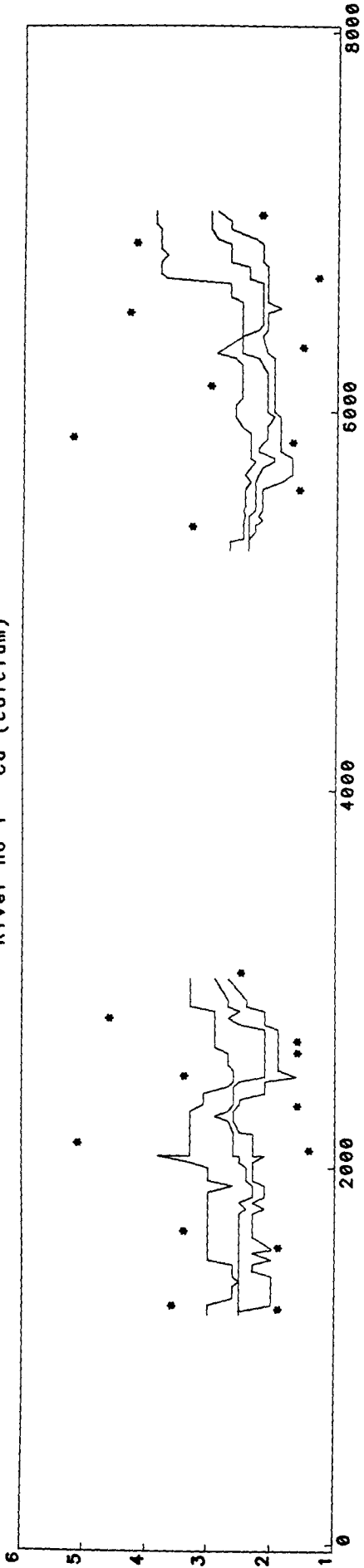

River no 2 Ca (calcium)

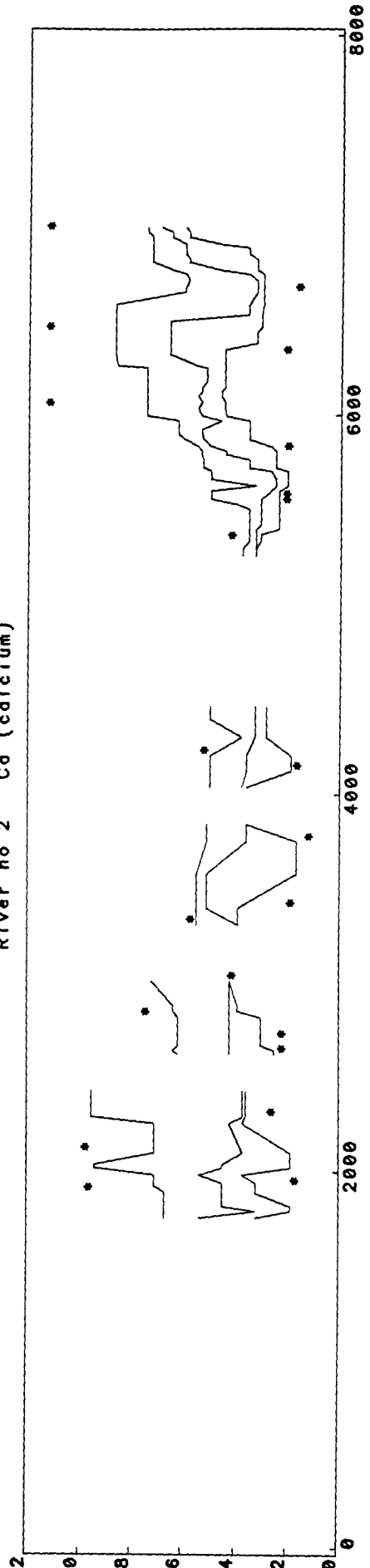

River no 3 Ca (calcium)

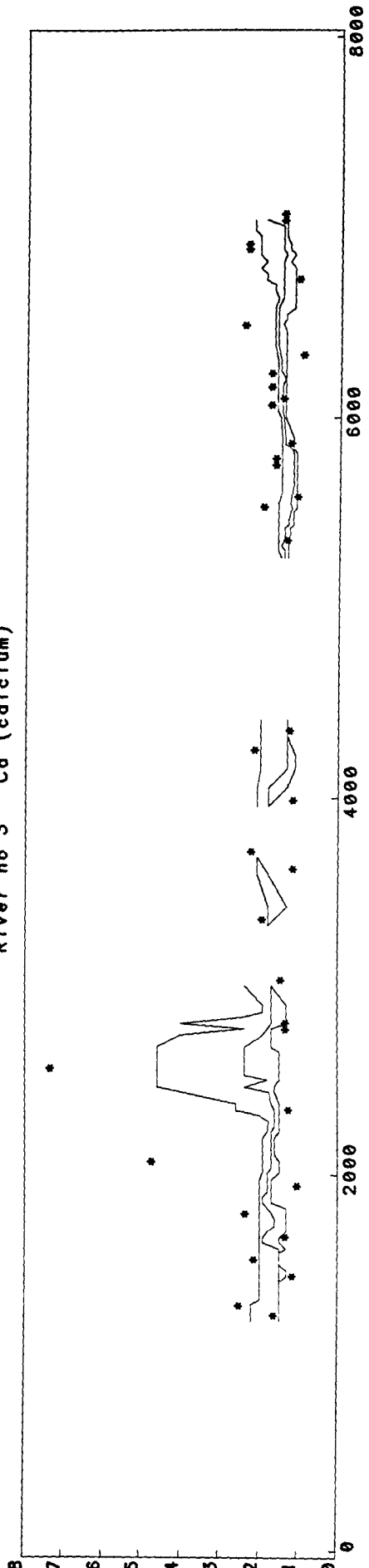

River no 4 Ca (calcium)

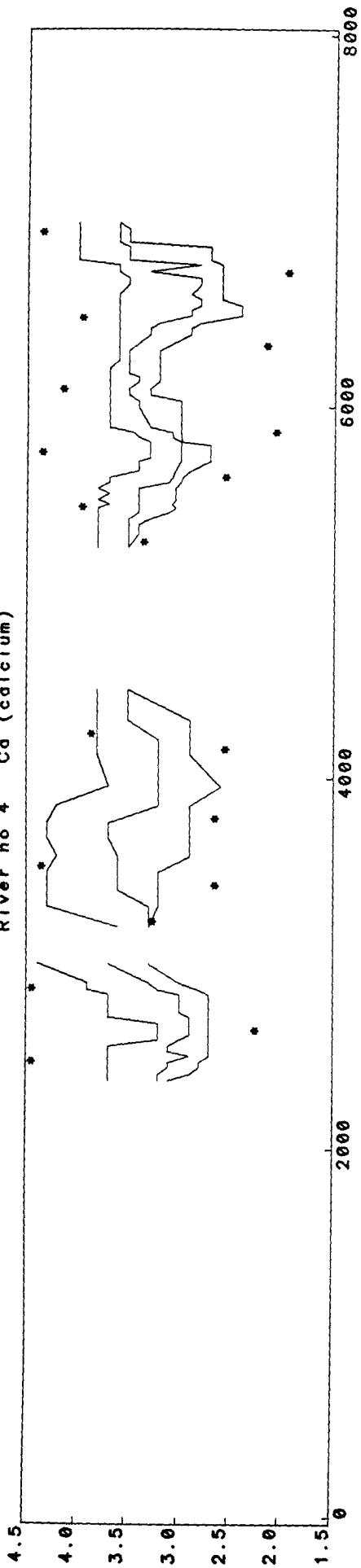

Julian Day  
River no 5 Ca (calcium)

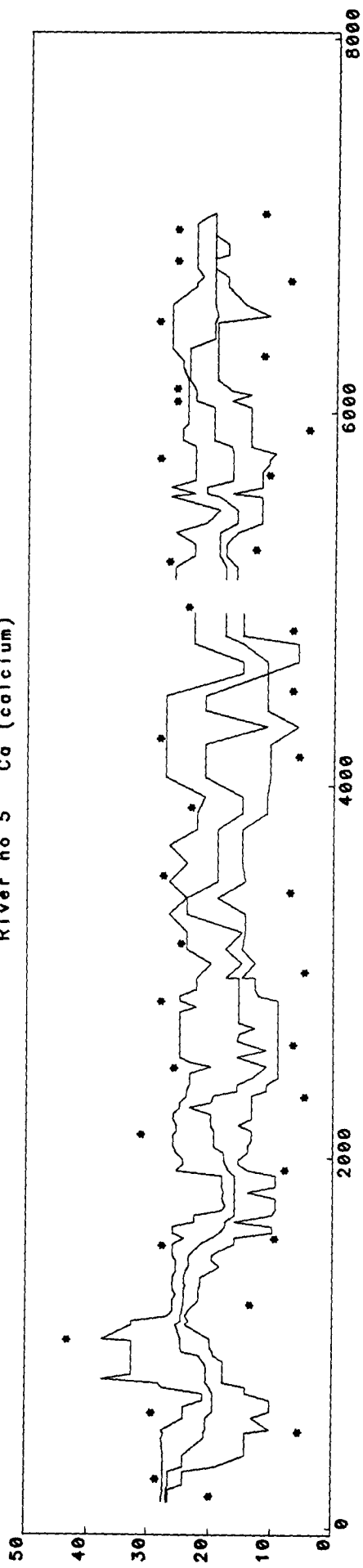

Julian Day  
River no 6 Ca (calcium)

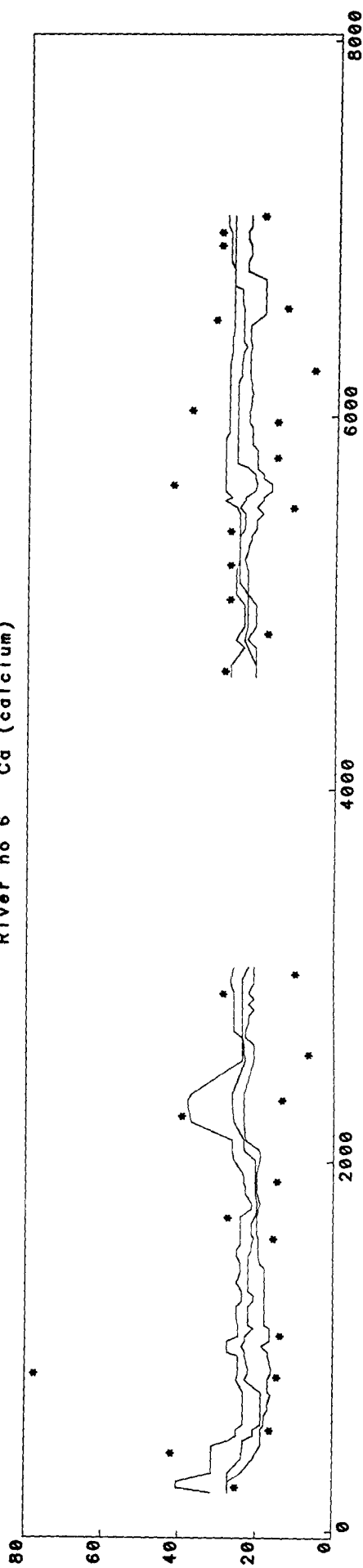

River no 7 Ca (calcium)

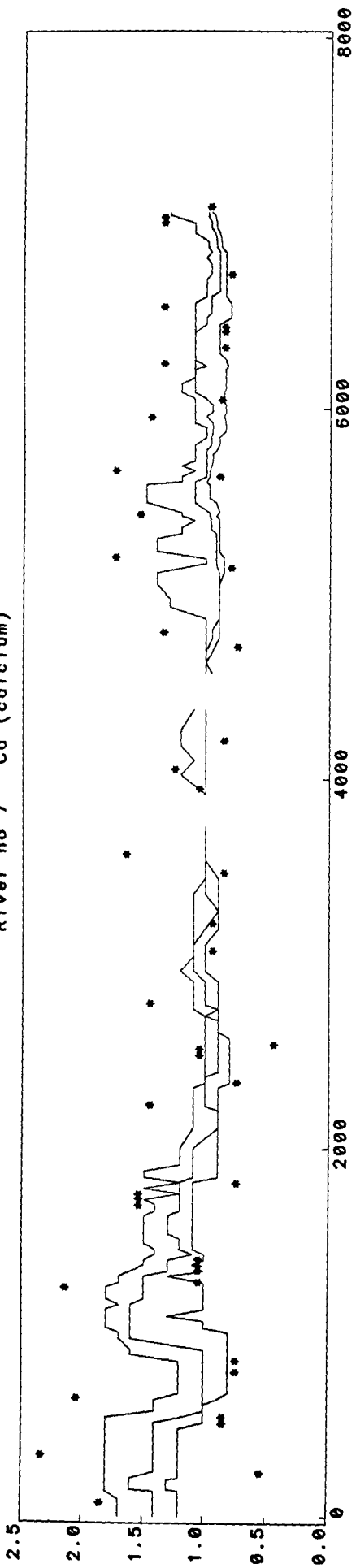

River no 8 Ca (calcium)

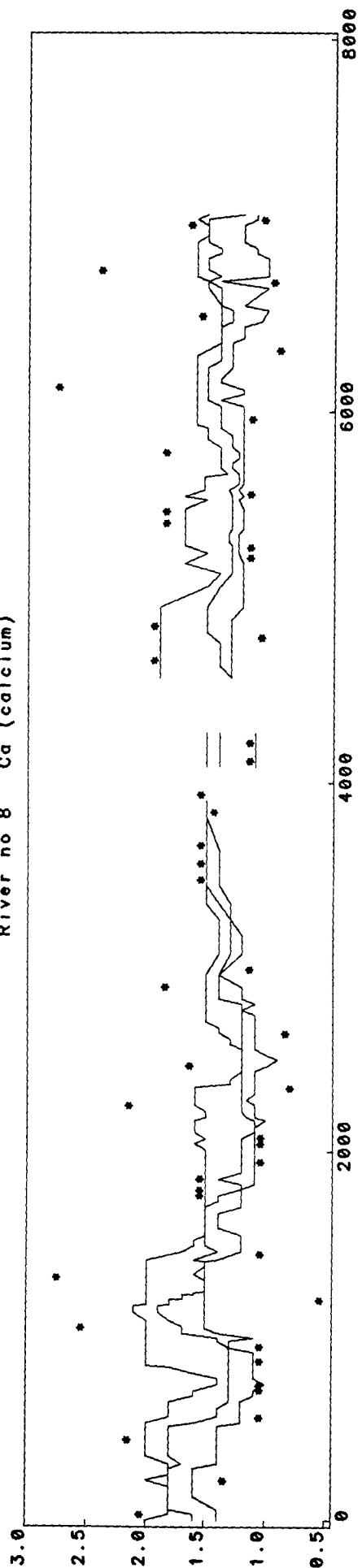

River no 9 Ca (calcium)

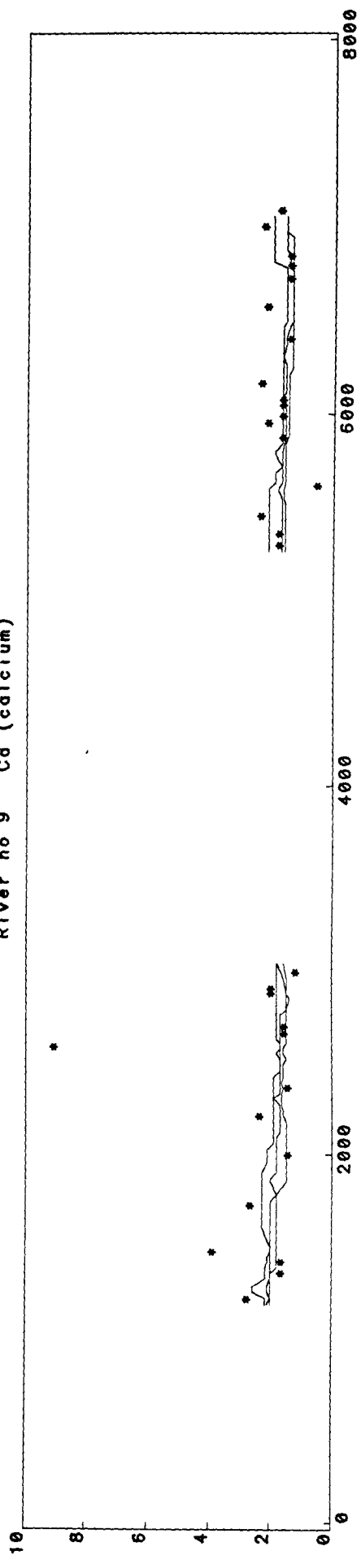

River no 10 Ca (calcium)

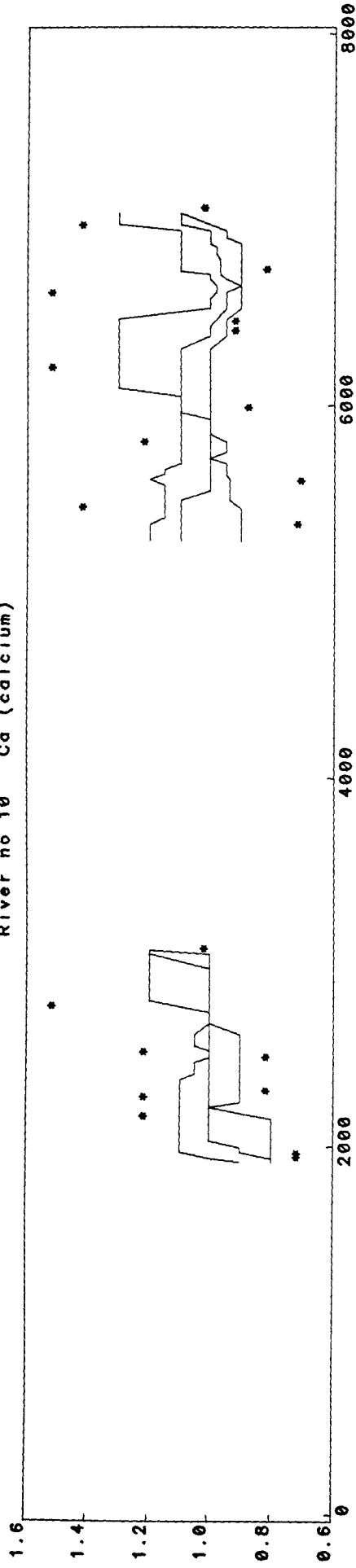

River no 11 Ca (calcium)

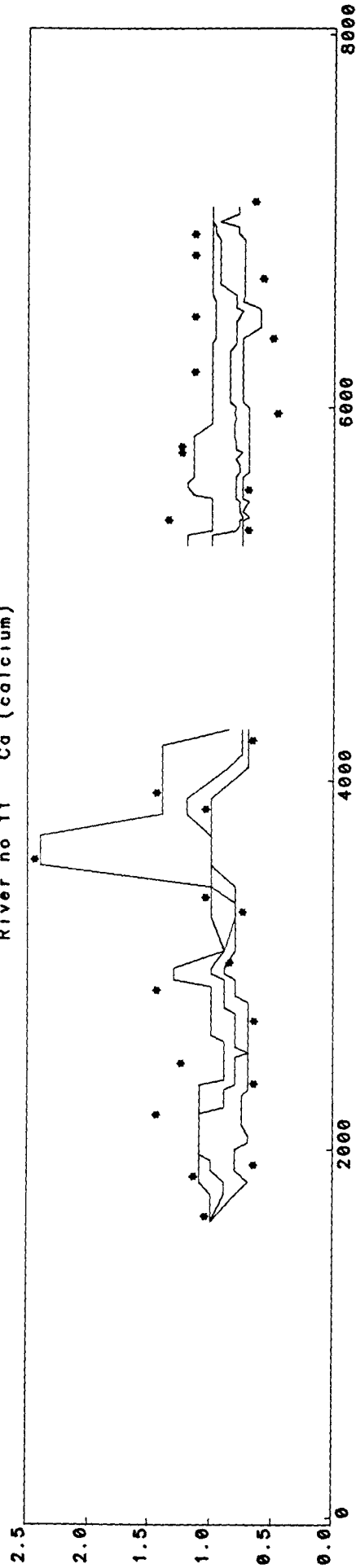

River no 12 Ca (calcium)

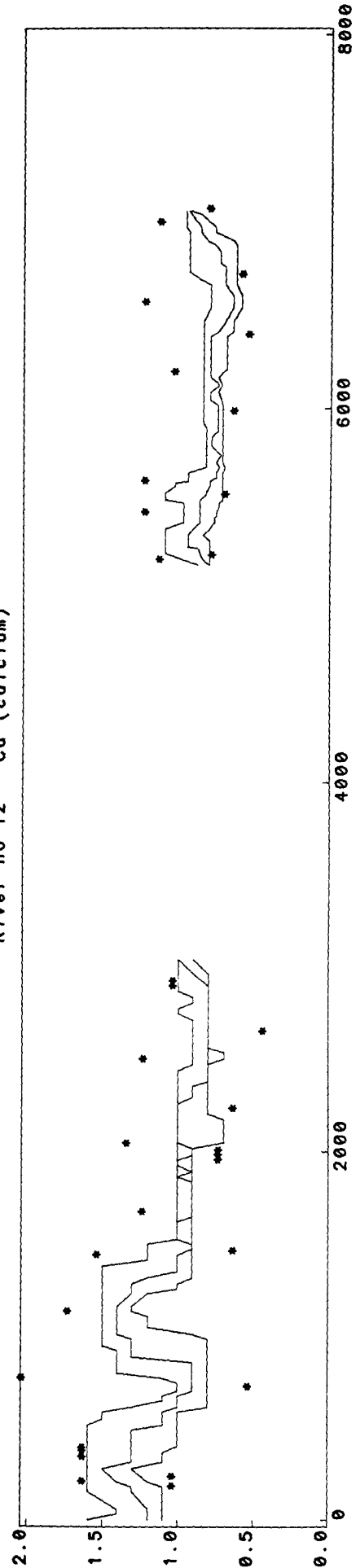

River no 13 Ca (calcium)

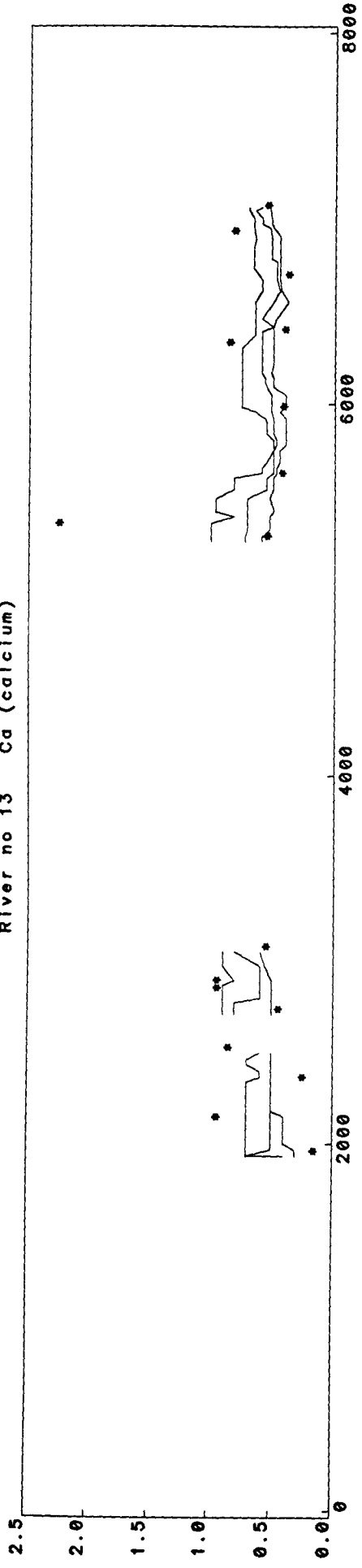

River no 16 Ca (calcium)

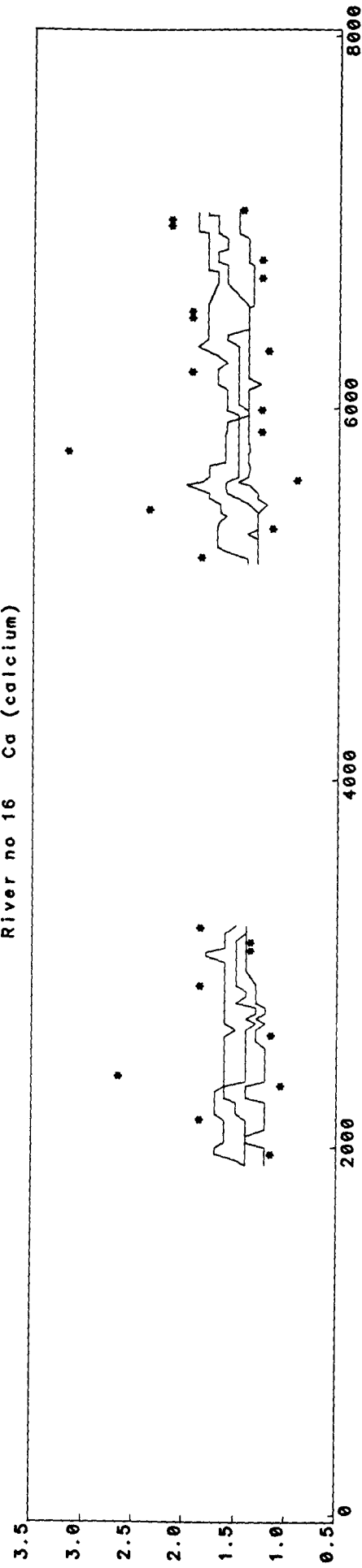

River no 17 Ca (calcium)

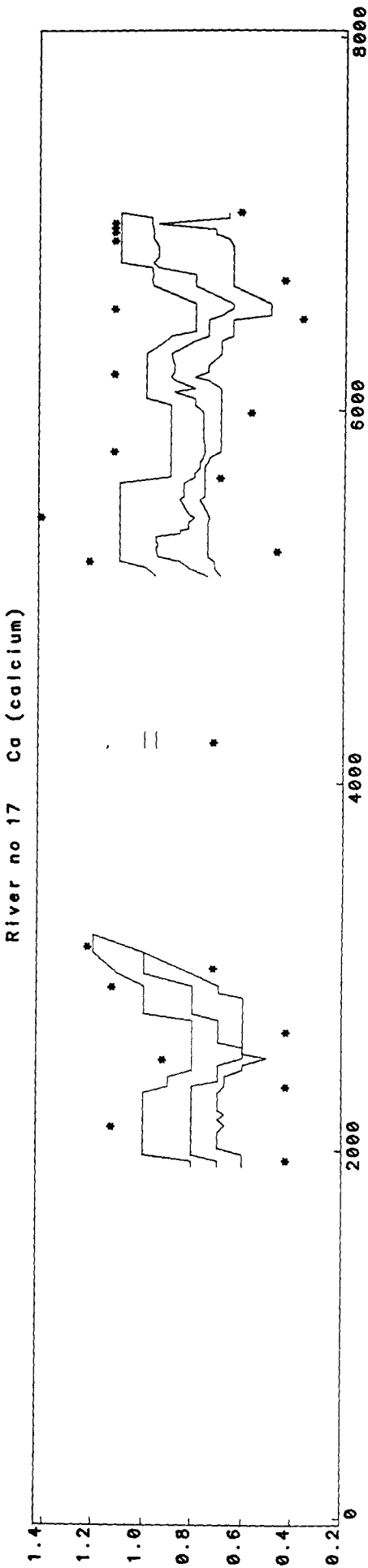

River no 18 Ca (calcium)

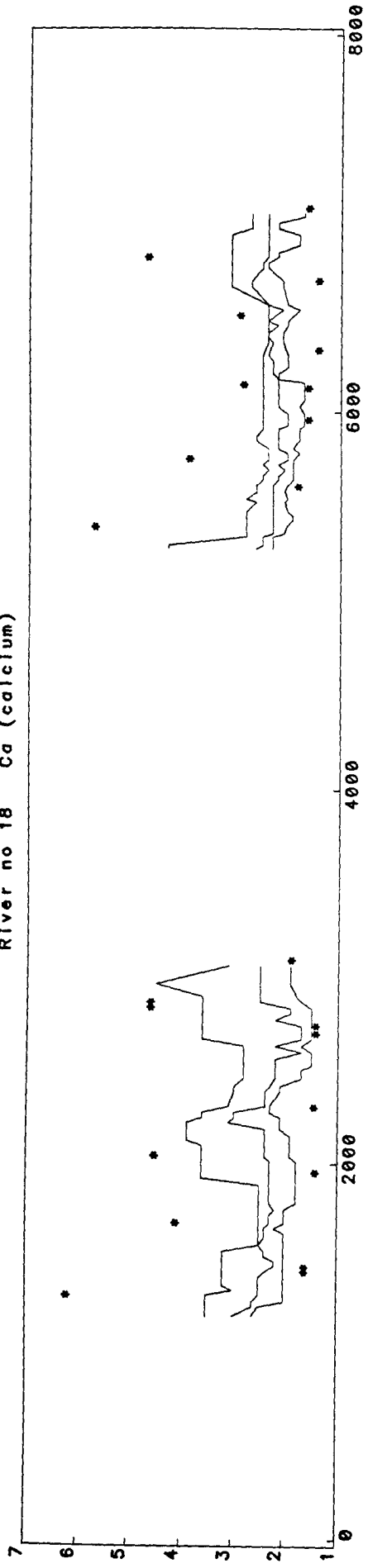

River no 19 Ca (calcium)

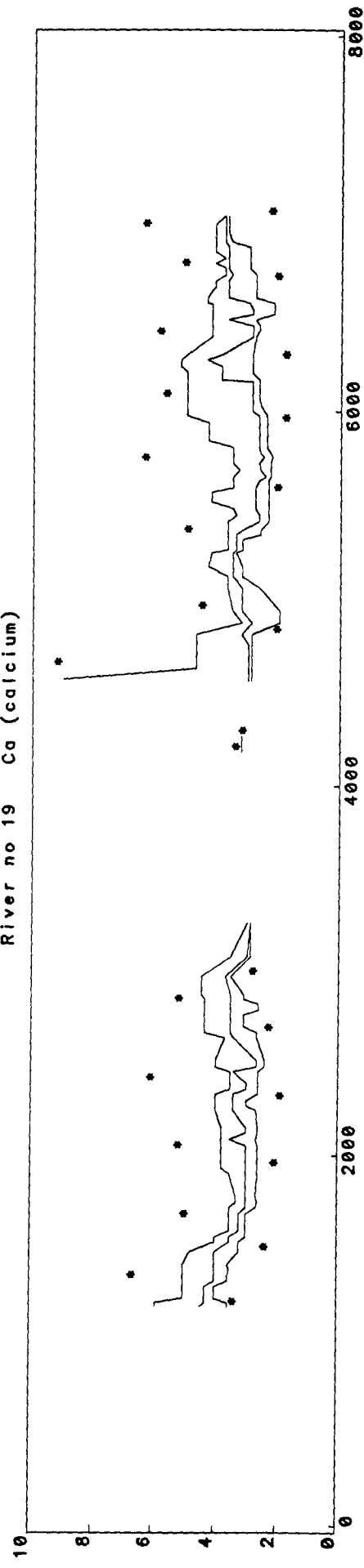

River no 20 Ca (calcium)

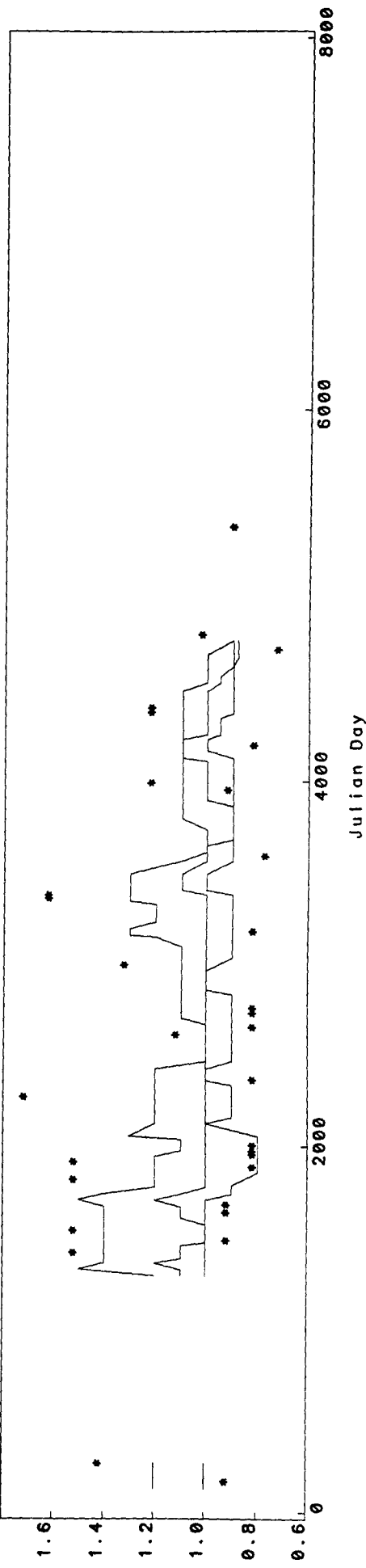



River no 21 Ca (calcium)

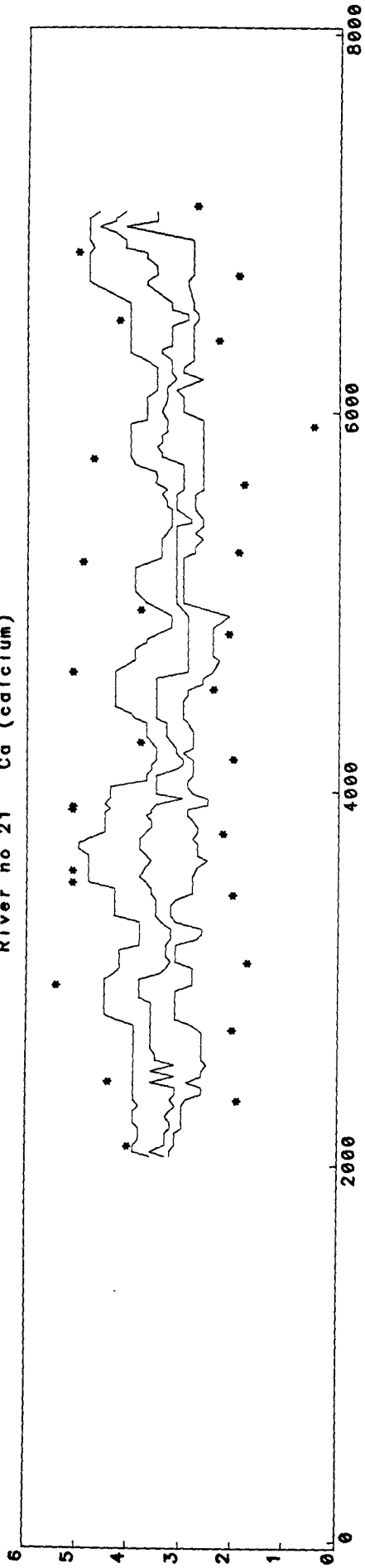

River no 22 Ca (calcium)

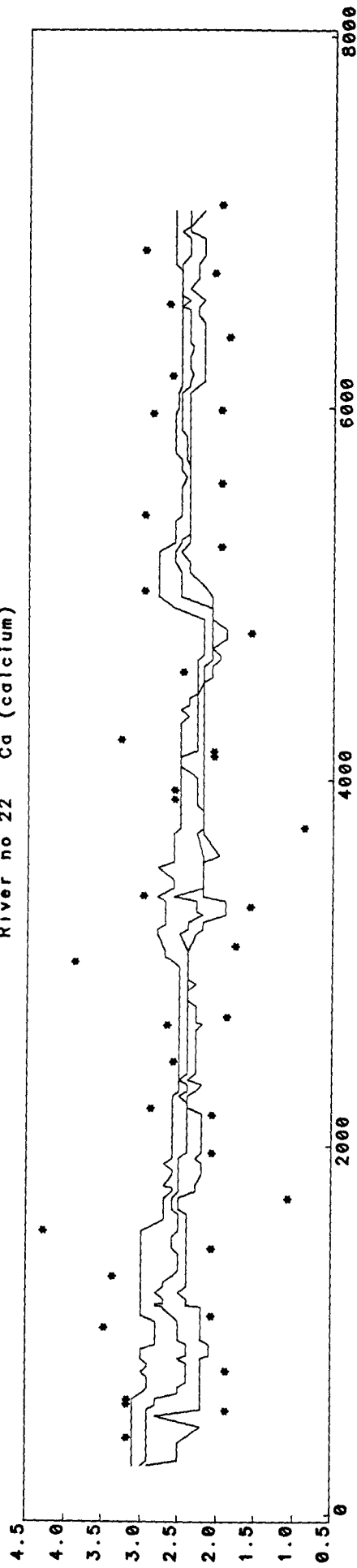

River no 23 Ca (calcium)

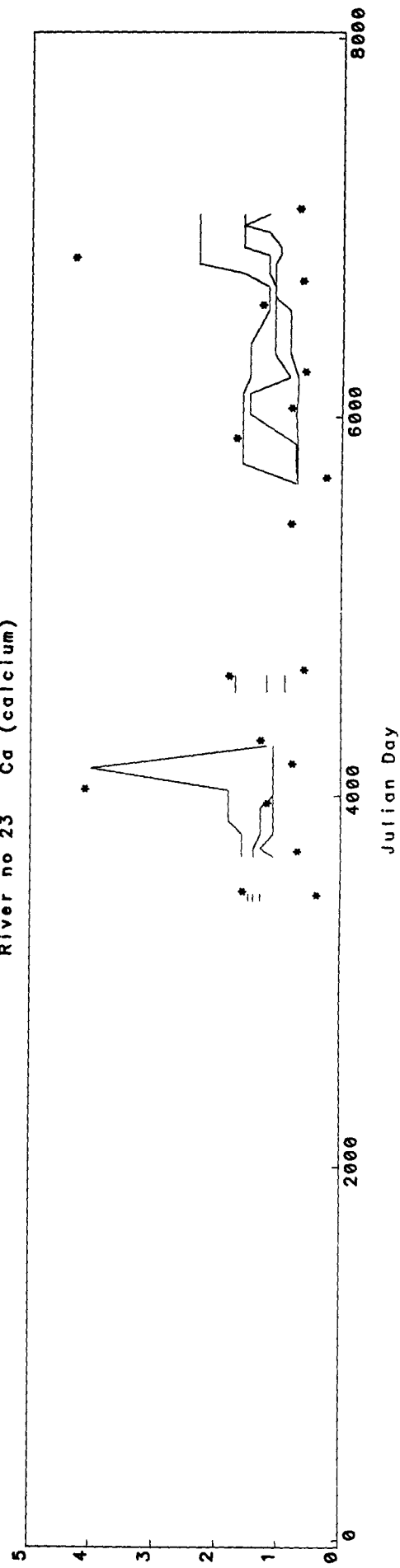

River no 25 Ca (calcium)

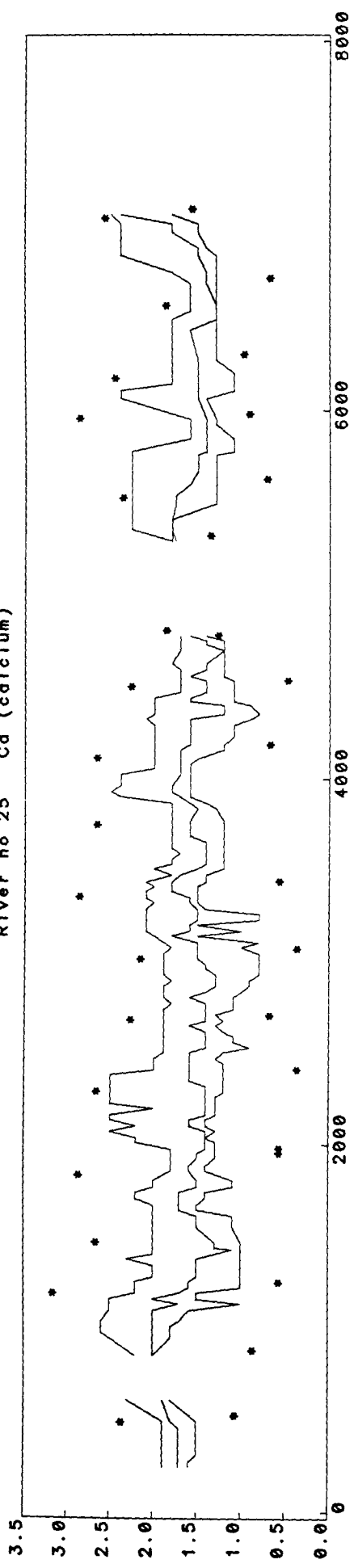

River no 26 Ca (calcium)

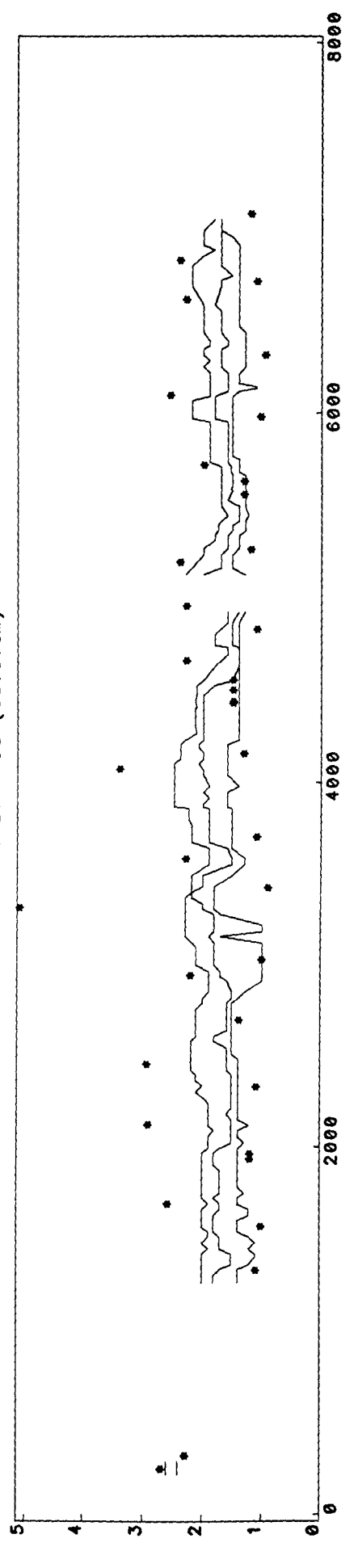

River no 27 Ca (calcium)

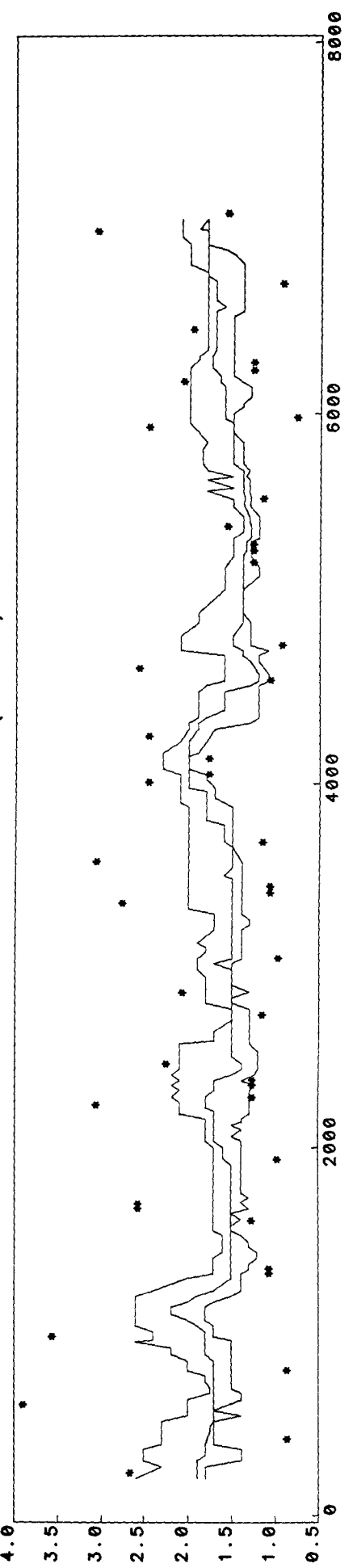

River no 28 Ca (calcium)

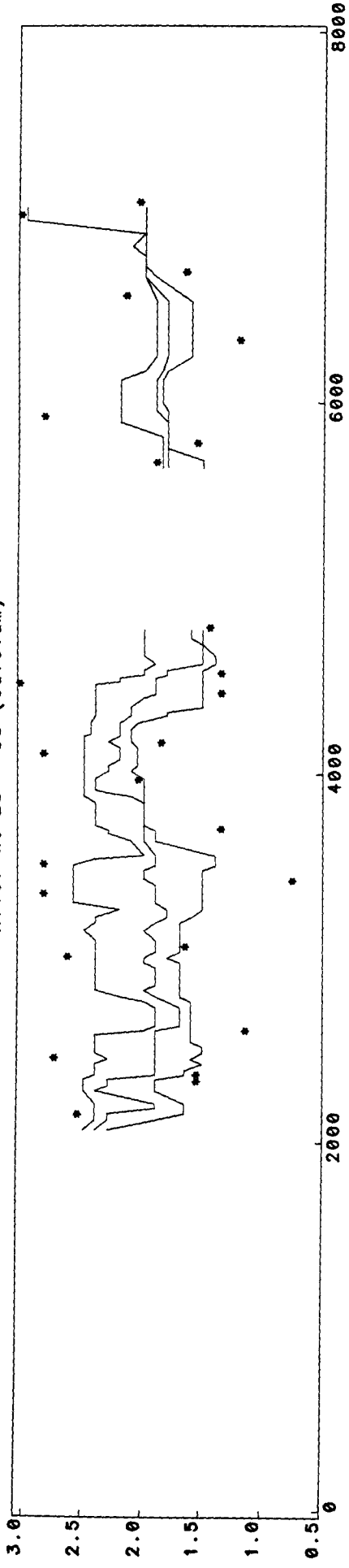

Julian Day

Appendix 13. Running boxplots of iron for the study rivers.

River no 1 Fe (Iron)

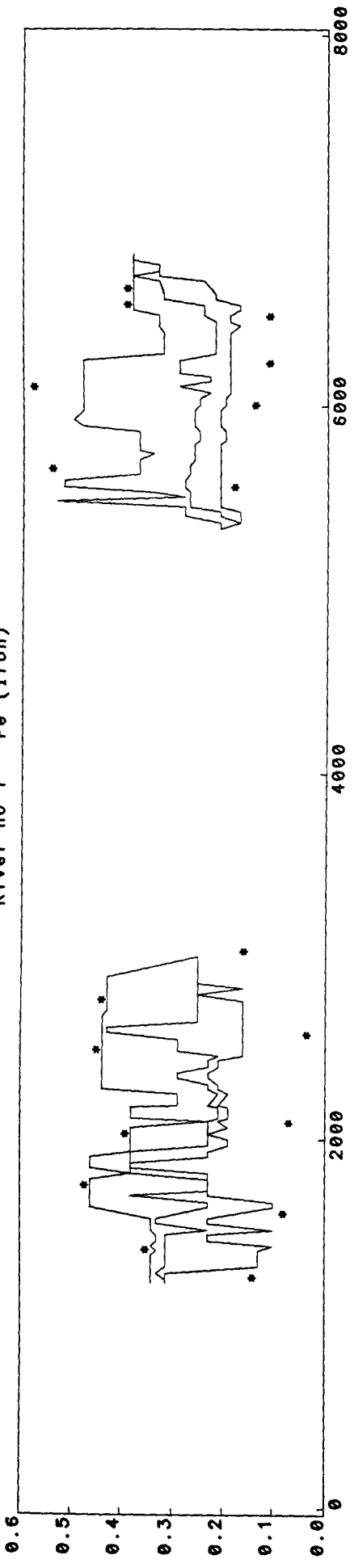

River no 2 Fe (Iron)

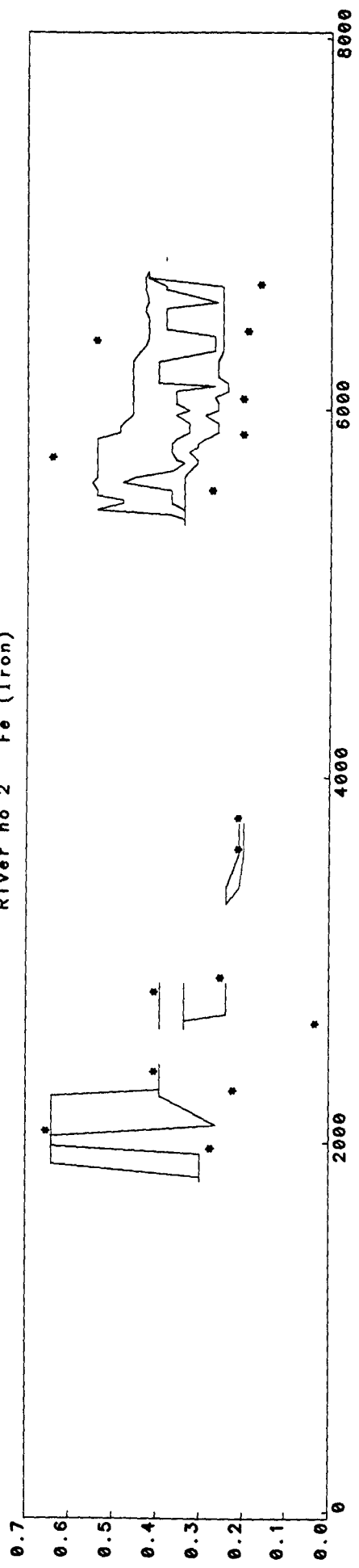

River no 3 Fe (Iron)

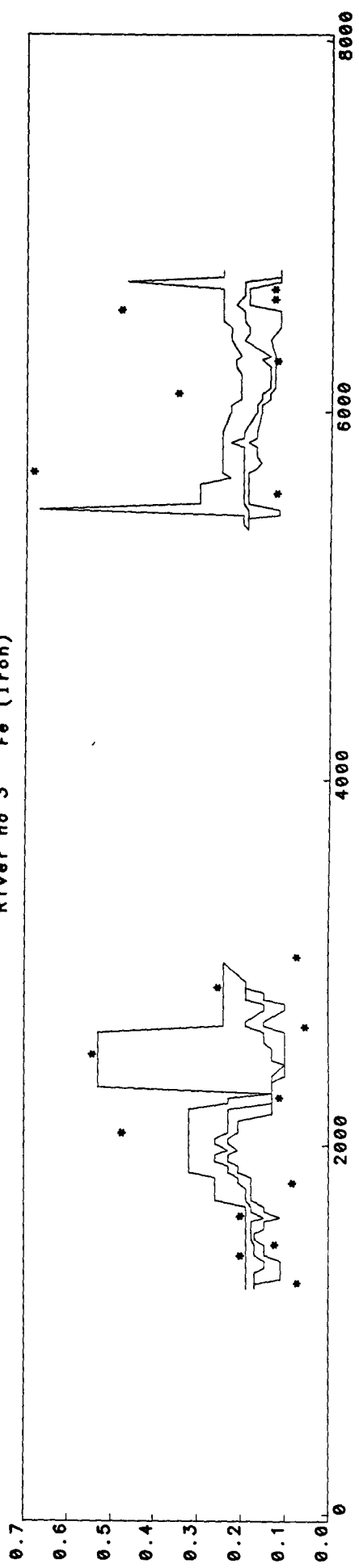

River no 4 Fe (Iron)

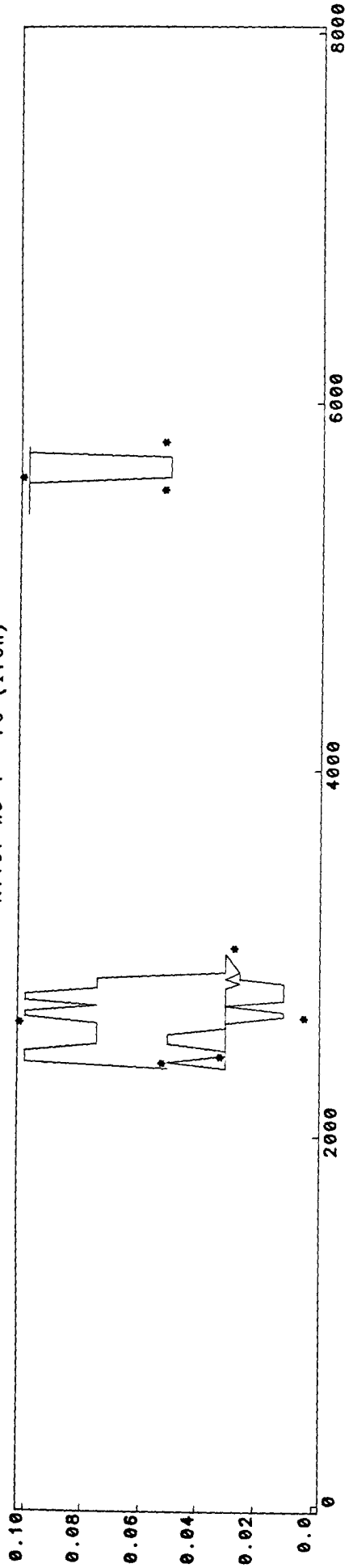

Julian Day  
River no 5 Fe (Iron)

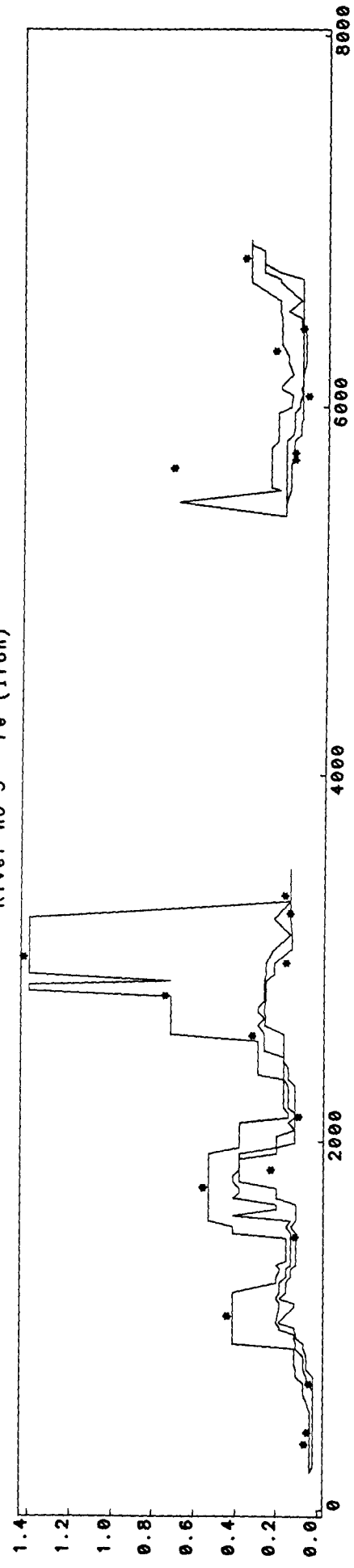

Julian Day  
River no 6 Fe (Iron)

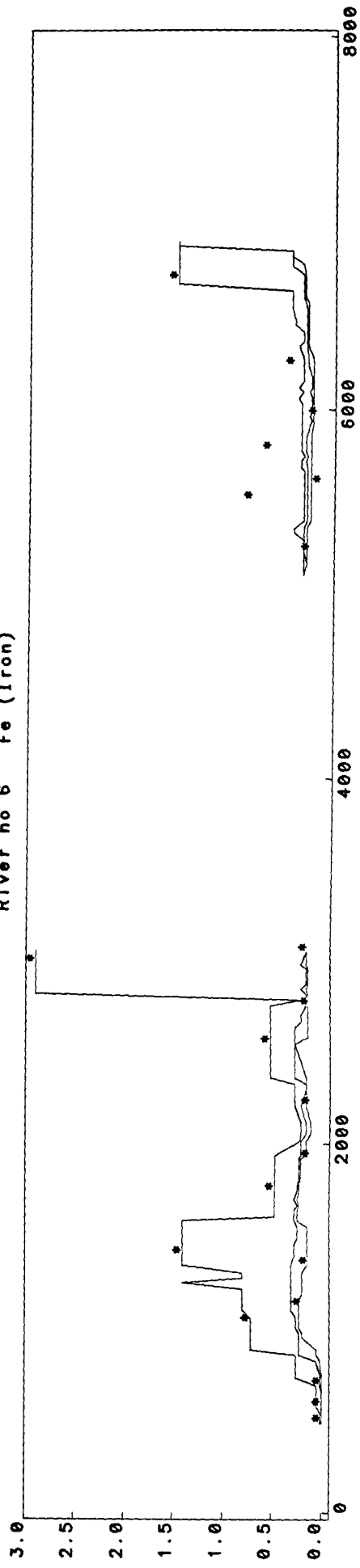

Julian Day

River no 7 Fe (Iron)

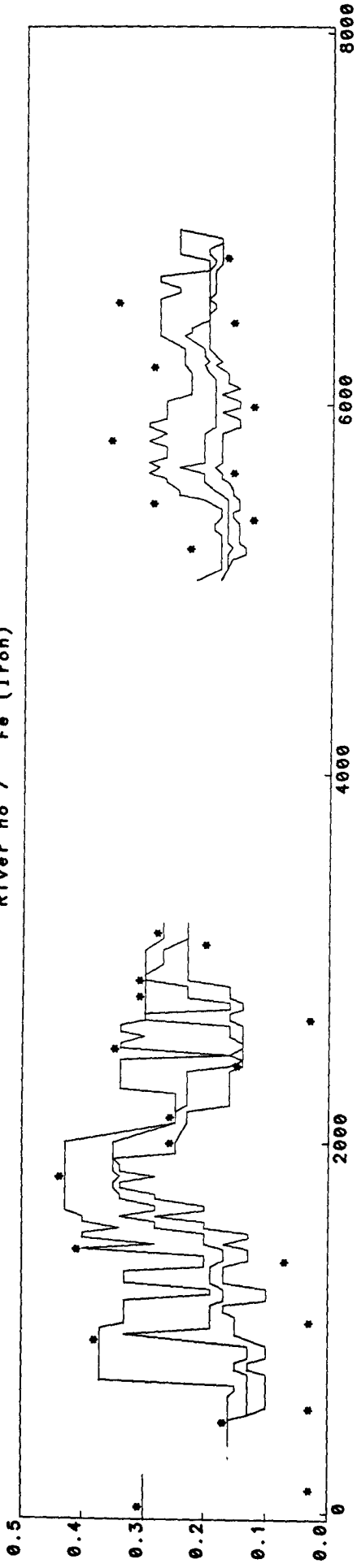

River no 8 Fe (Iron)

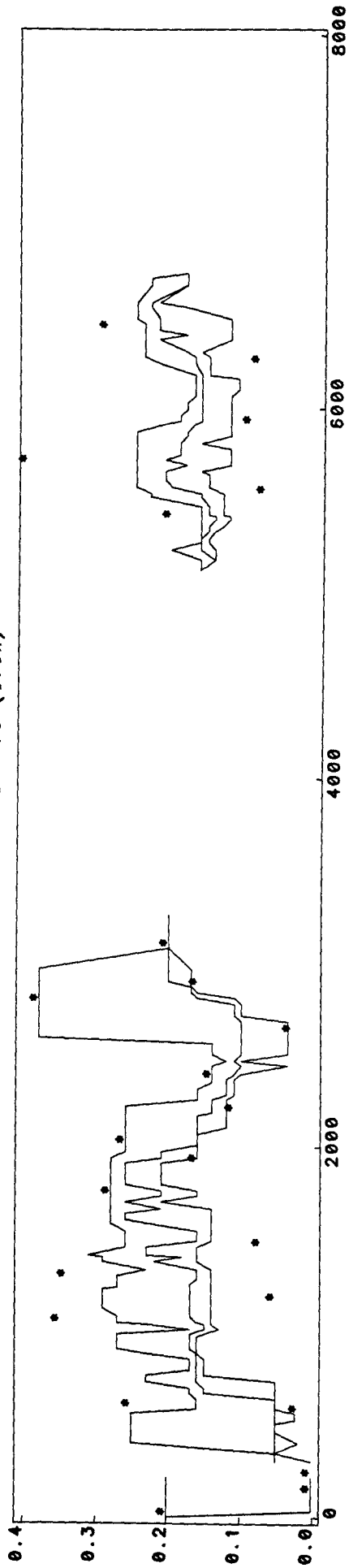

River no 9 Fe (Iron)

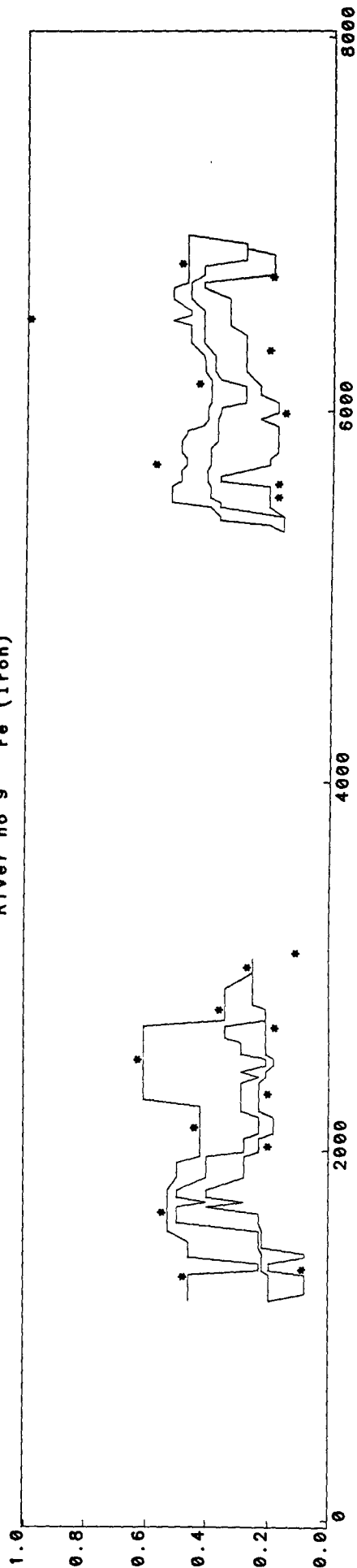

River no 10 Fe (Iron)

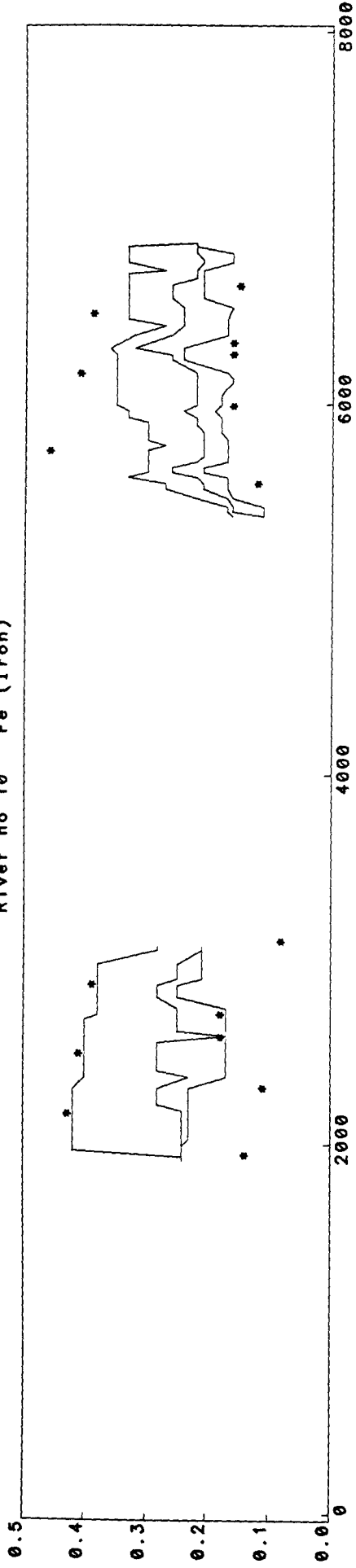

Julian Day  
River no 11 Fe (Iron)

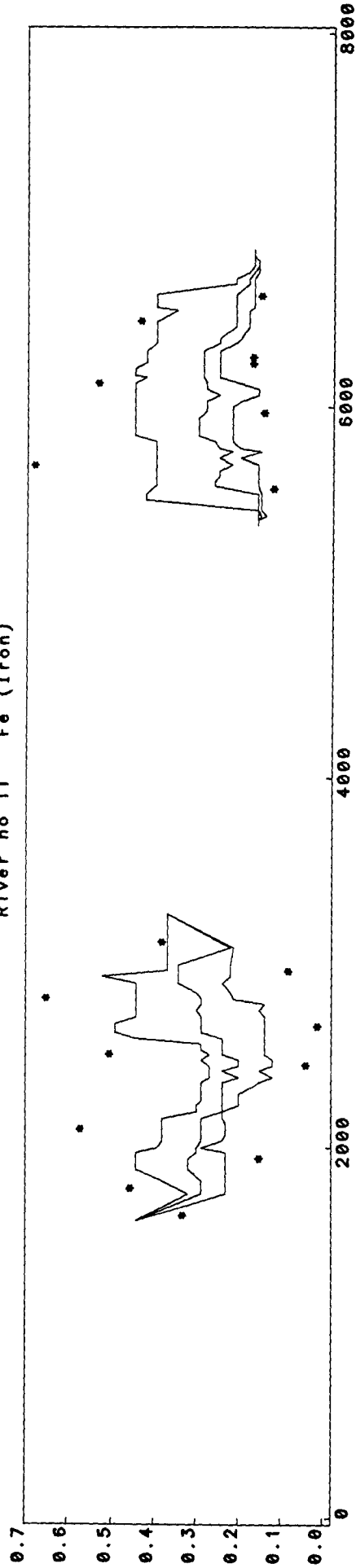

Julian Day  
River no 12 Fe (Iron)

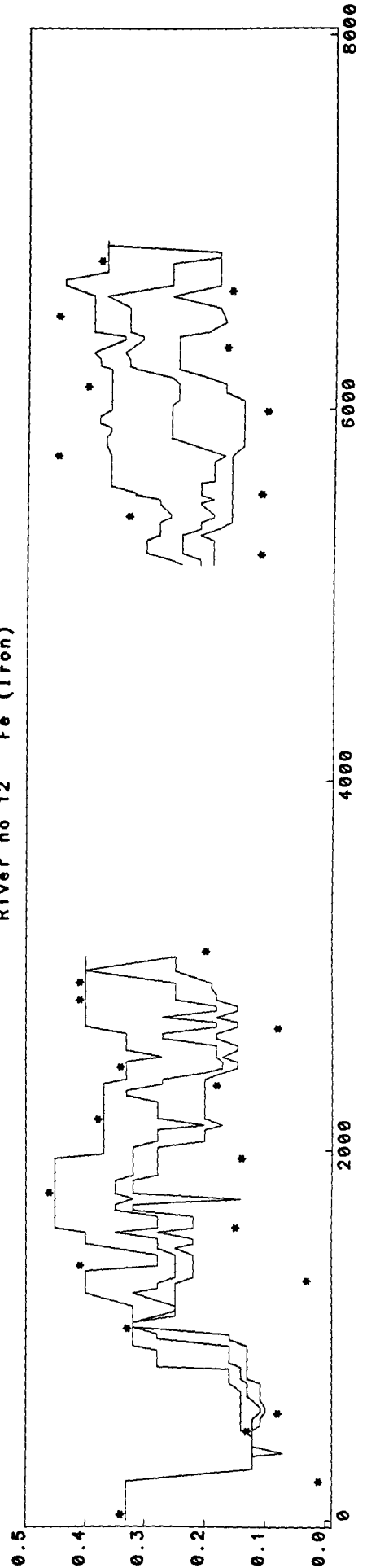

Julian Day



River no 13 Fe (Iron)

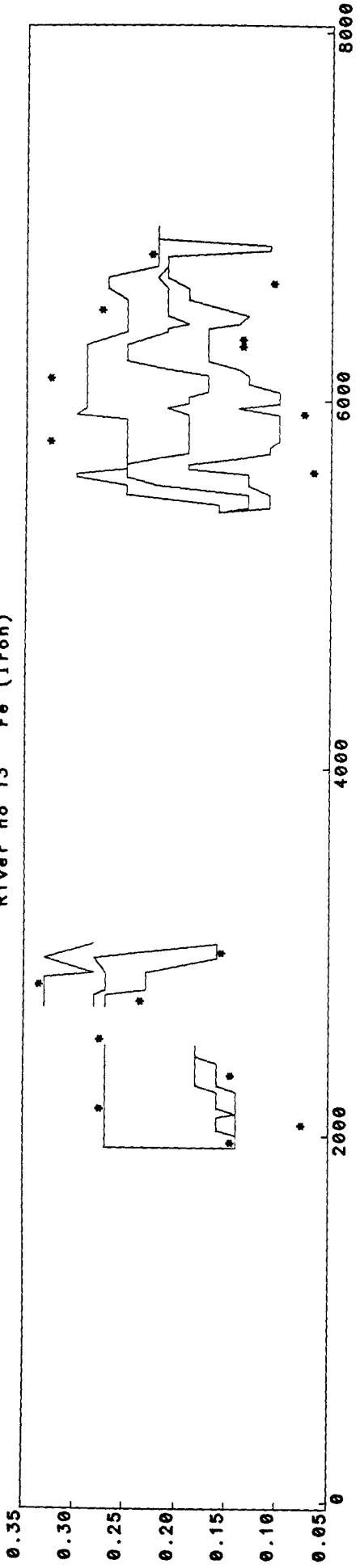

River no 16 Fe (Iron)

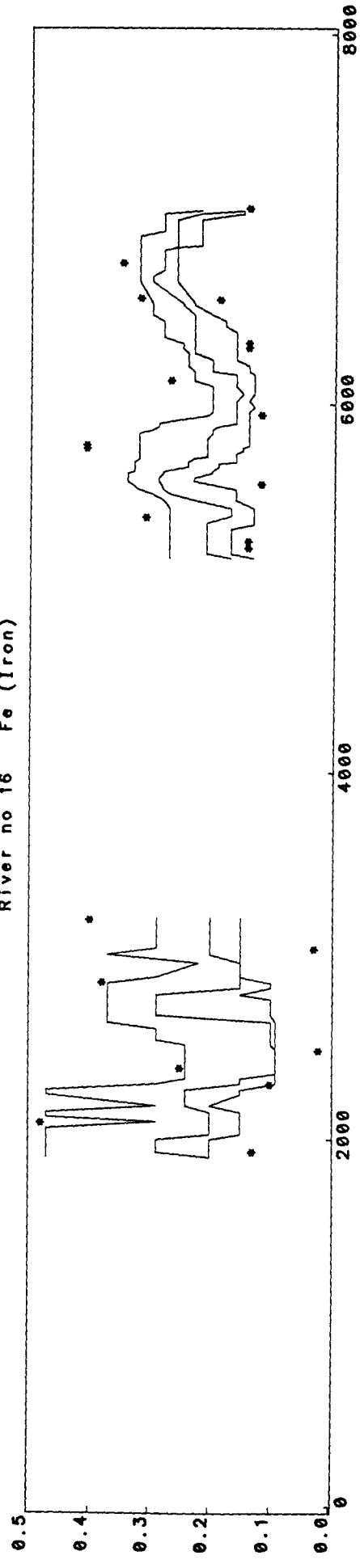

River no 17 Fe (Iron)

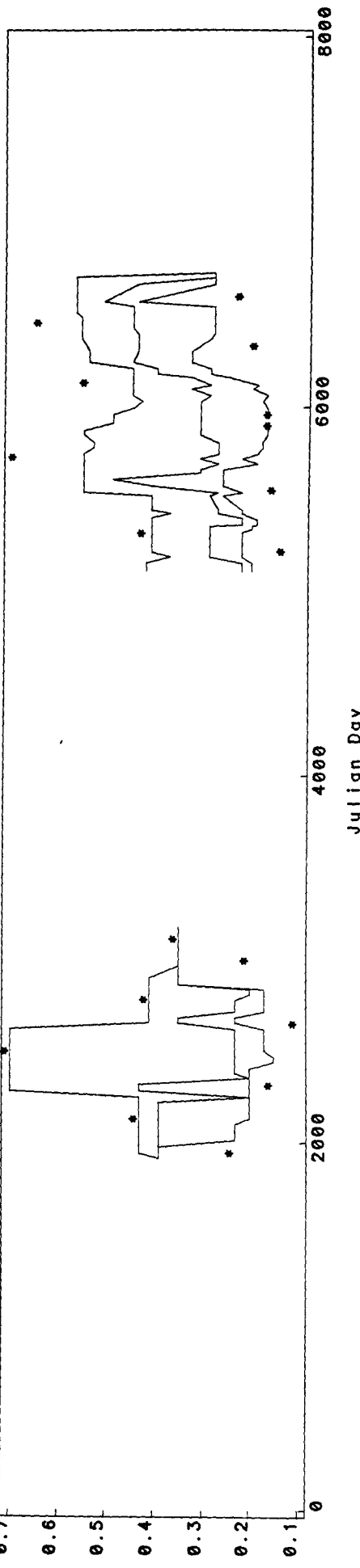

River no 18 Fe (Iron)

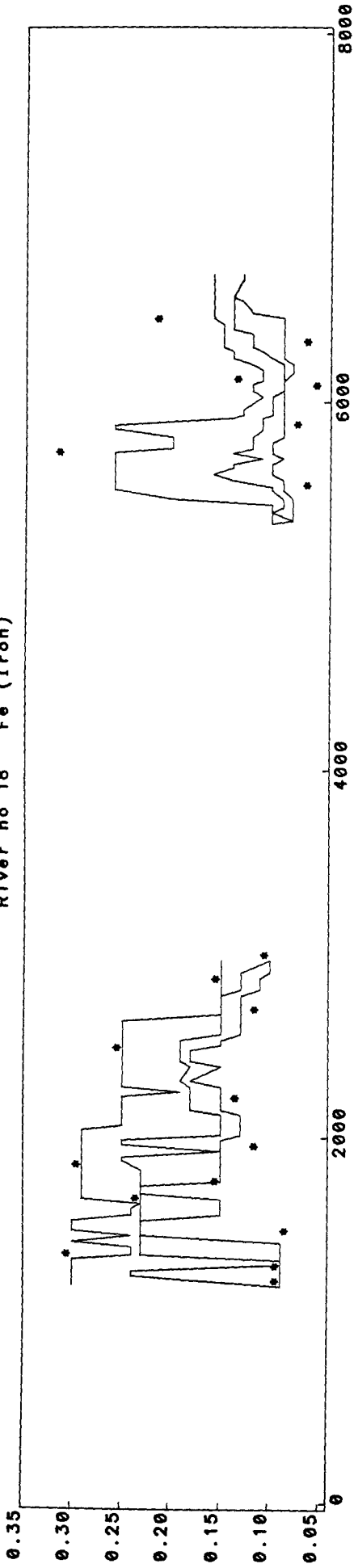

Julian Day  
River no 19 Fe (Iron)

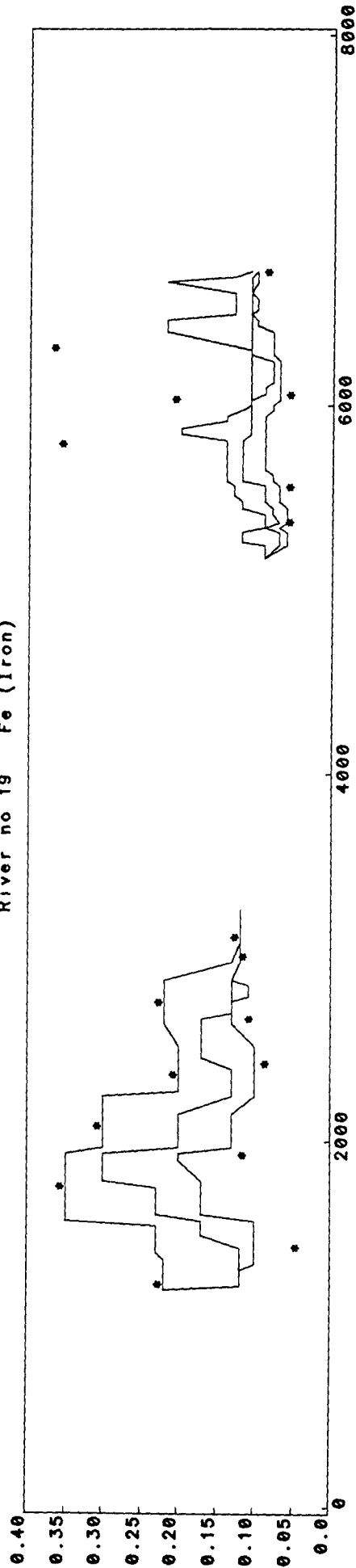

Julian Day  
River no 20 Fe (Iron)

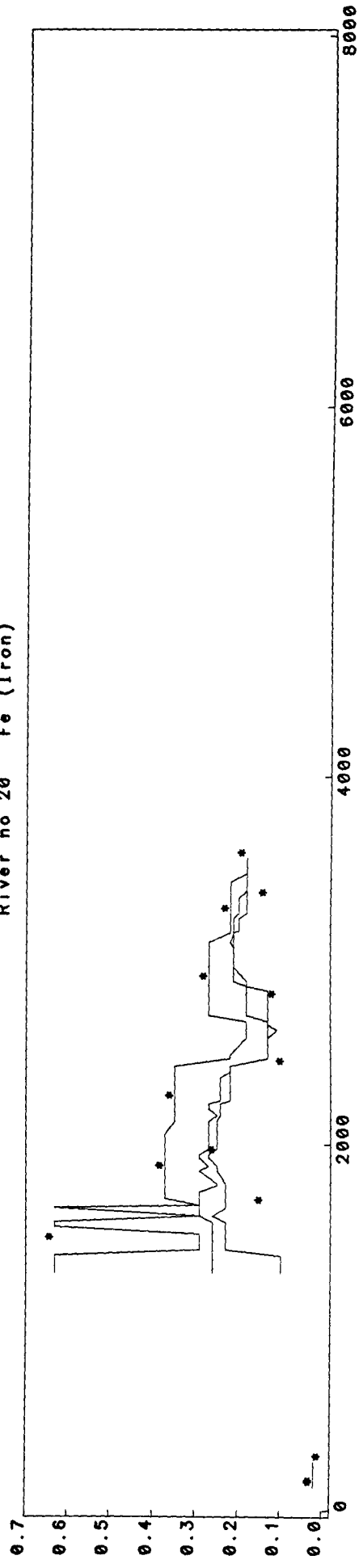

River no 21 Fe (Iron)

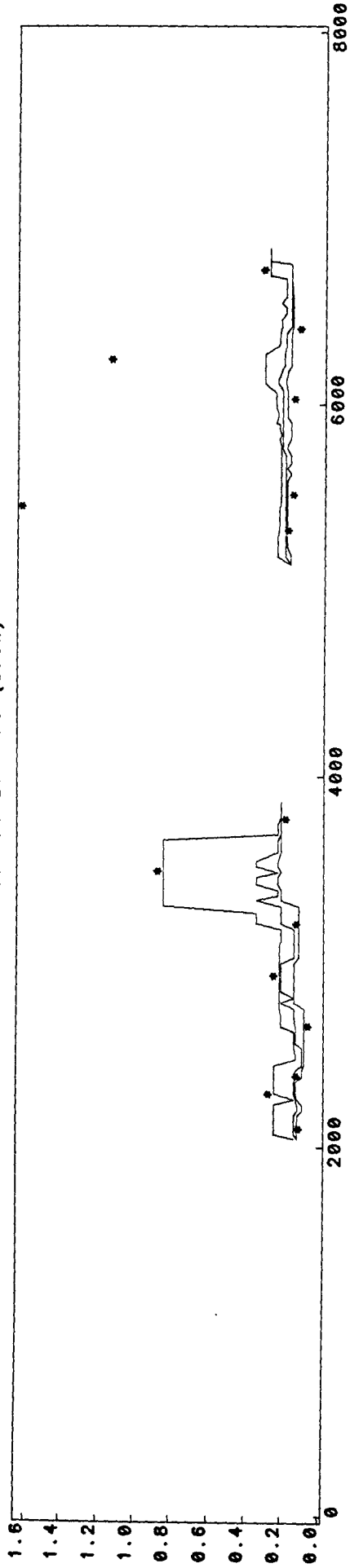

River no 22 Fe (Iron)

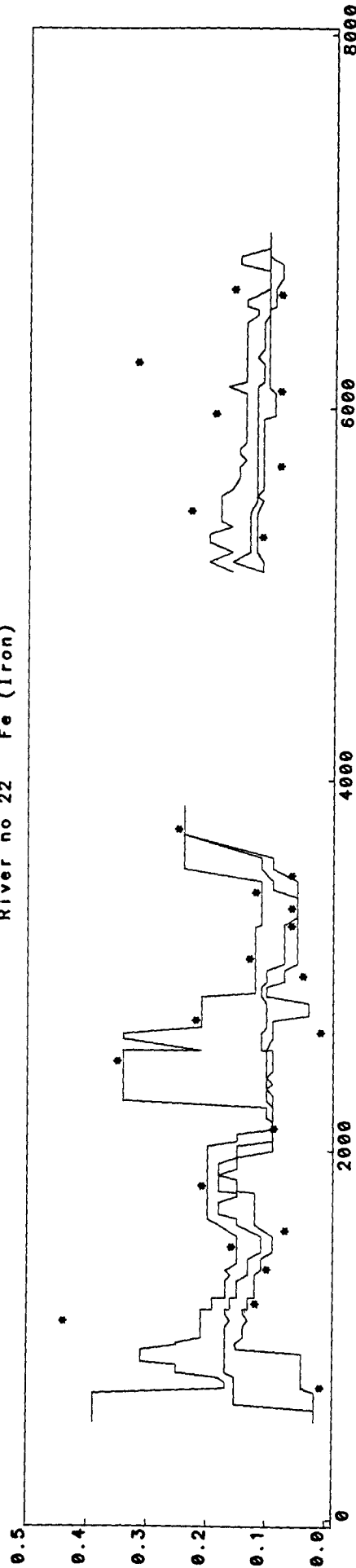

River no 23 Fe (Iron)

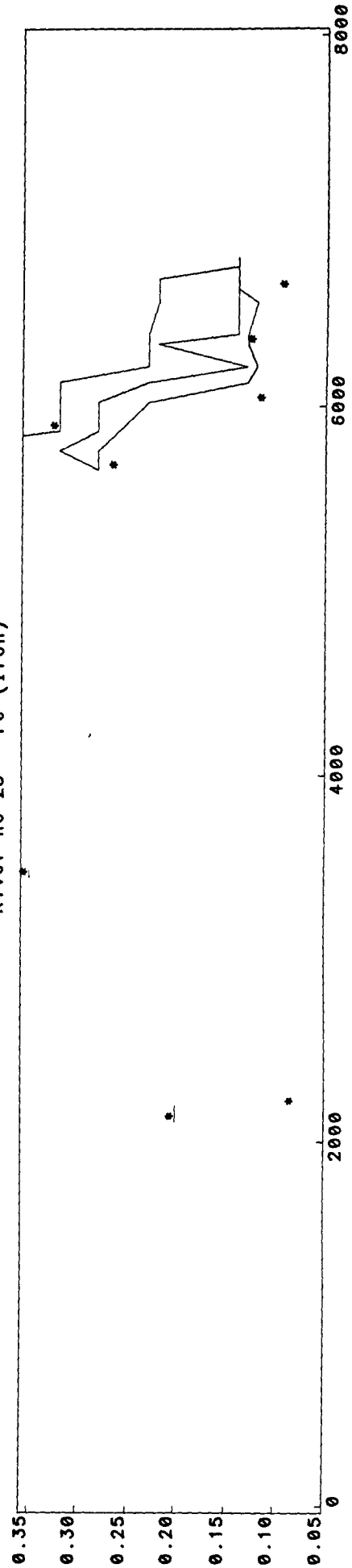

River no 25 Fe (Iron)

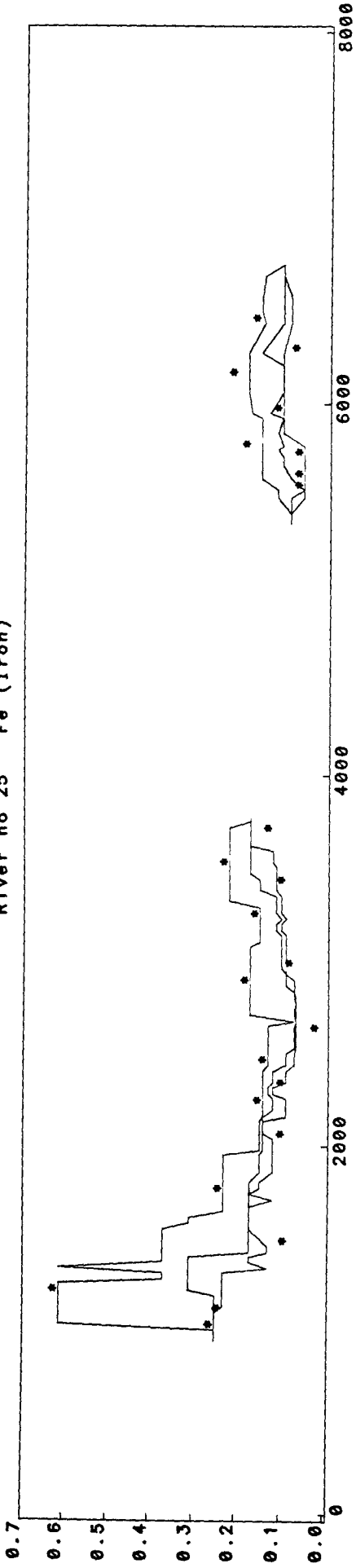

Julian Day  
River no 26 Fe (Iron)

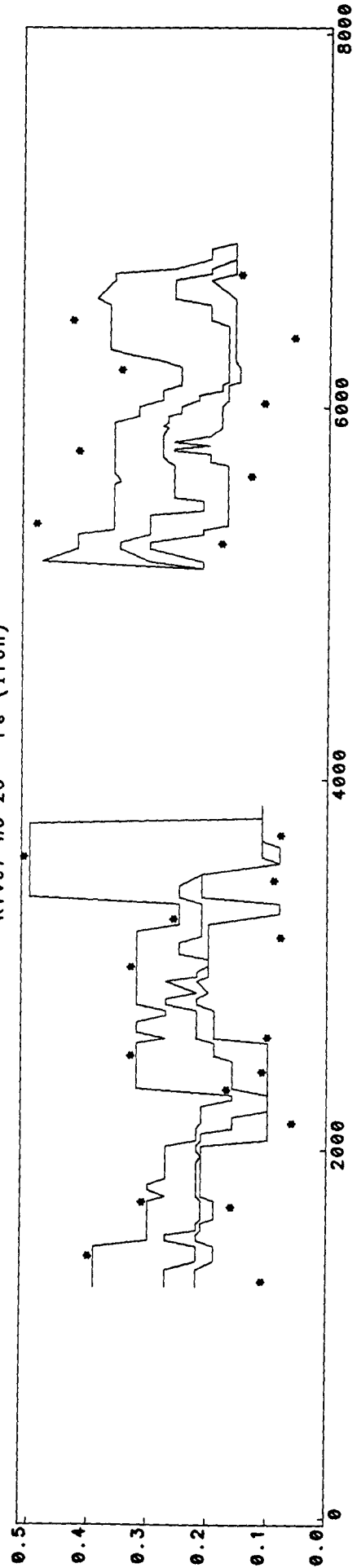

Julian Day  
River no 27 Fe (Iron)

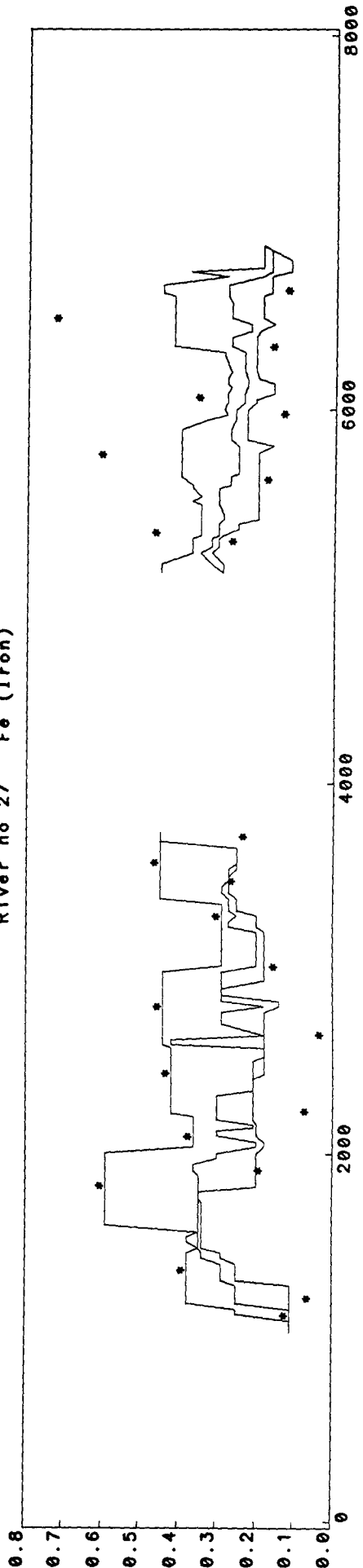

River no 28 Fe (Iron)

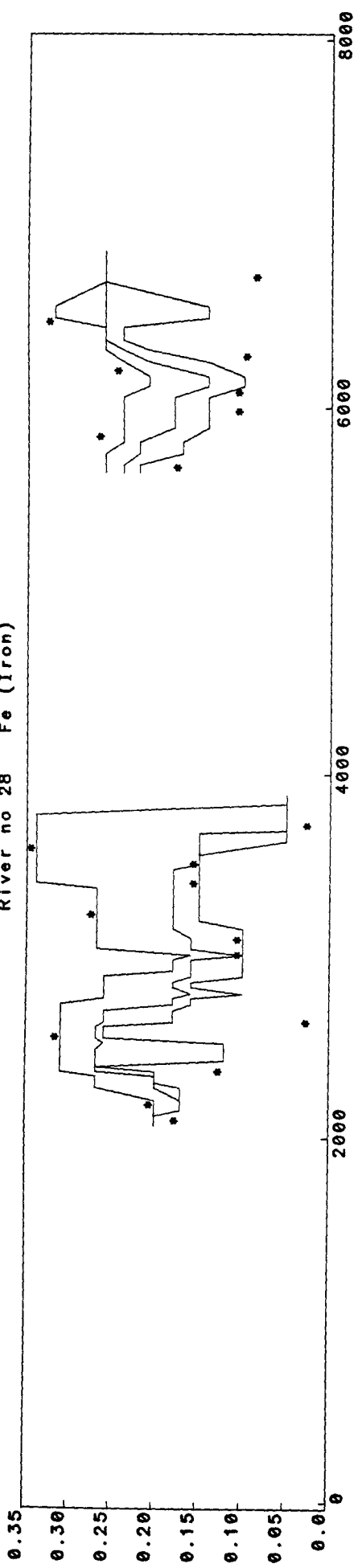

Appendix 14. Running boxplots of magnesium for the study rivers.

River no 1 Magnesium

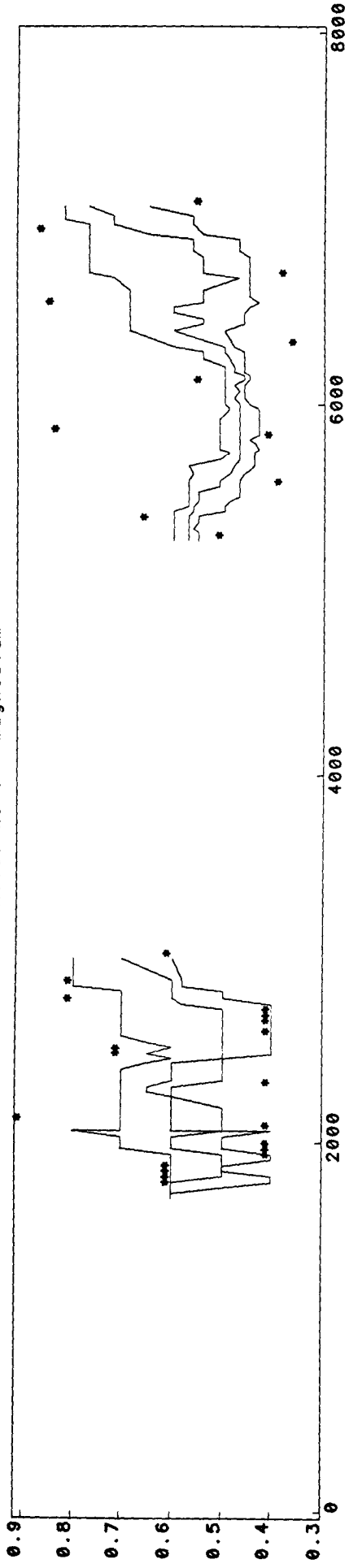

Julian Day  
River no 2 Magnesium

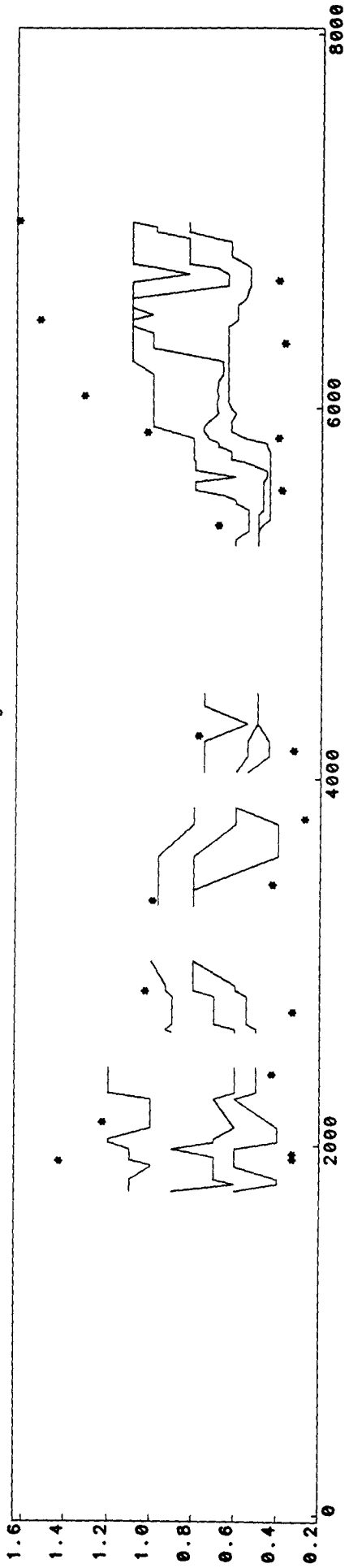

Julian Day  
River no 3 Magnesium

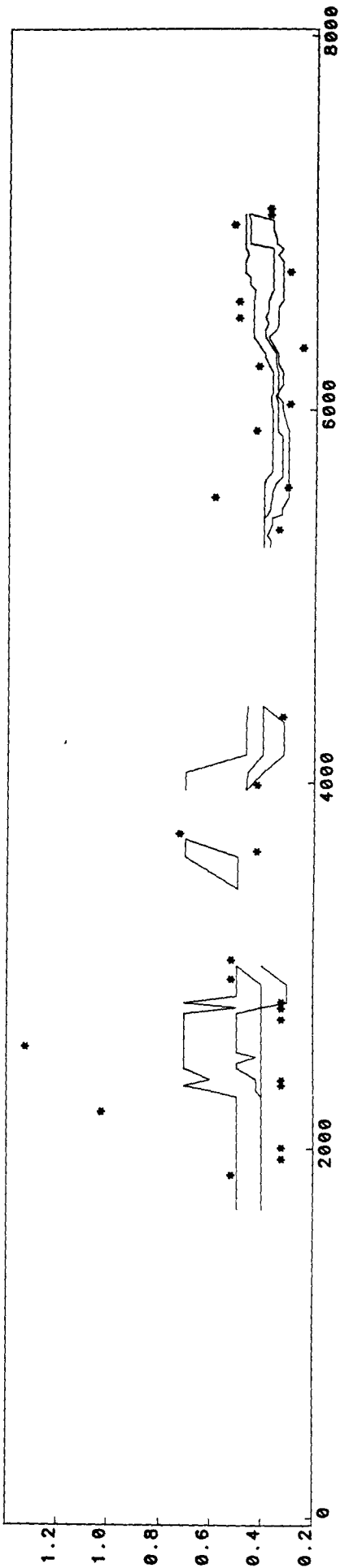

River no 4 Magnesium

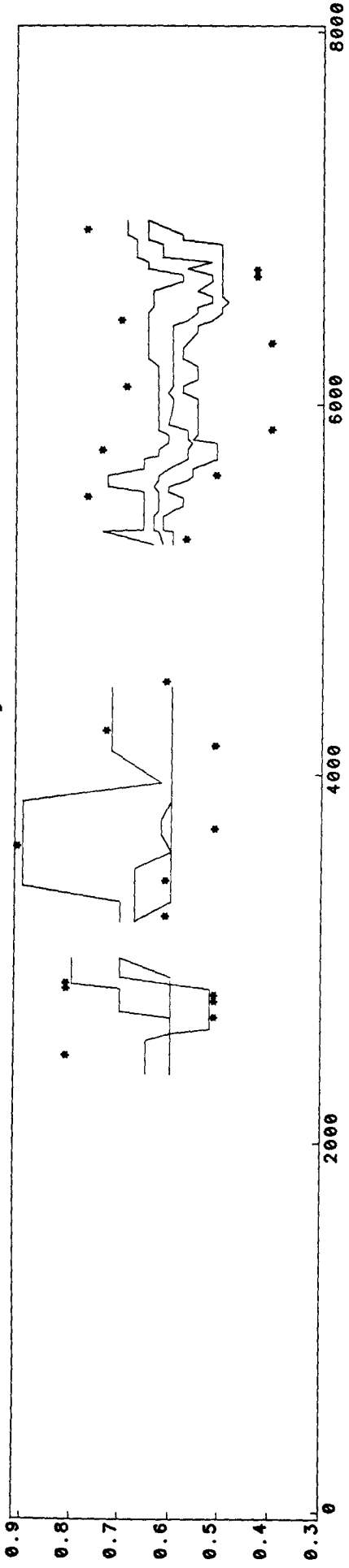

River no 5 Magnesium

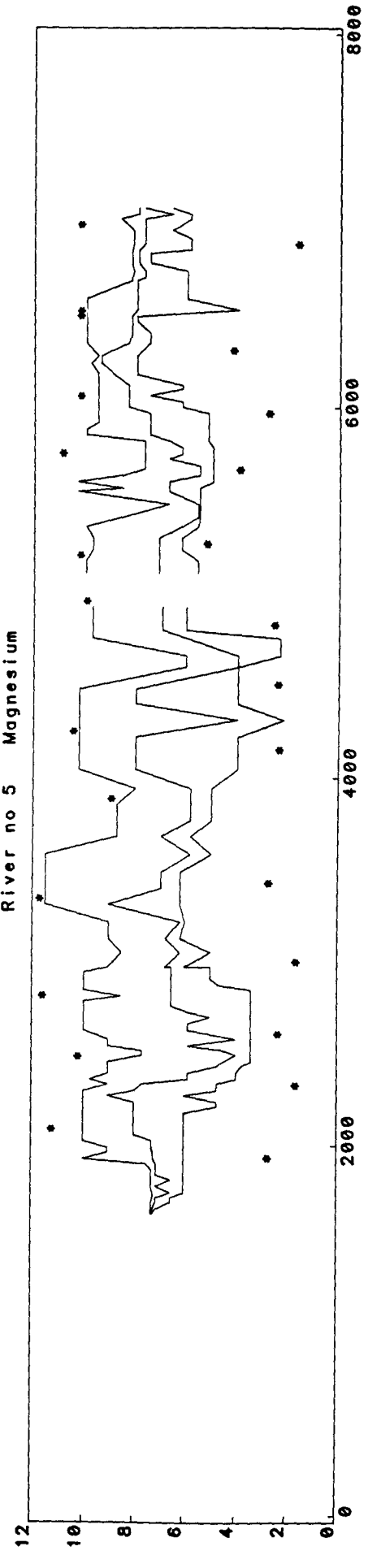

River no 6 Magnesium

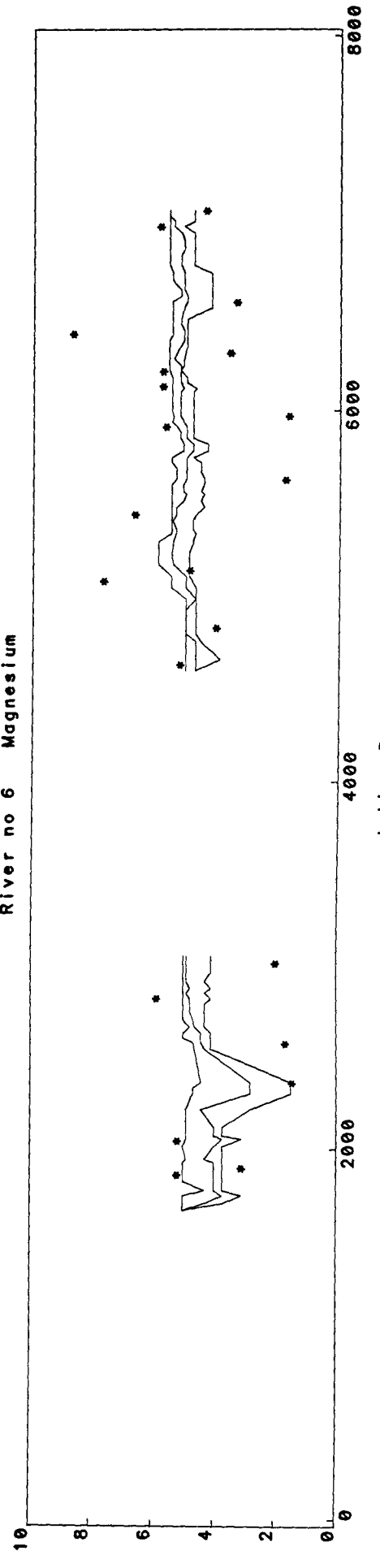



River no 7 Magnesium

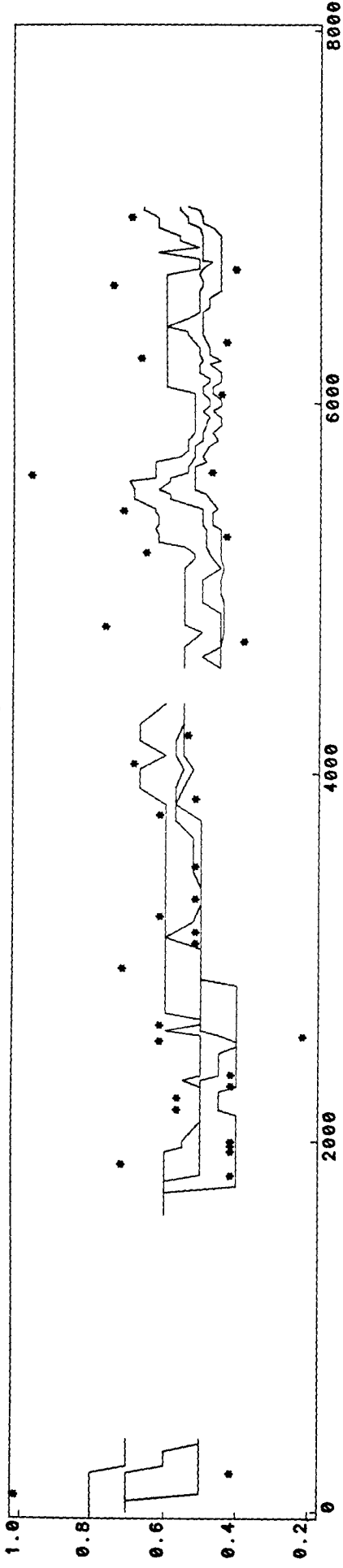

Julian Day  
River no 8 Magnesium

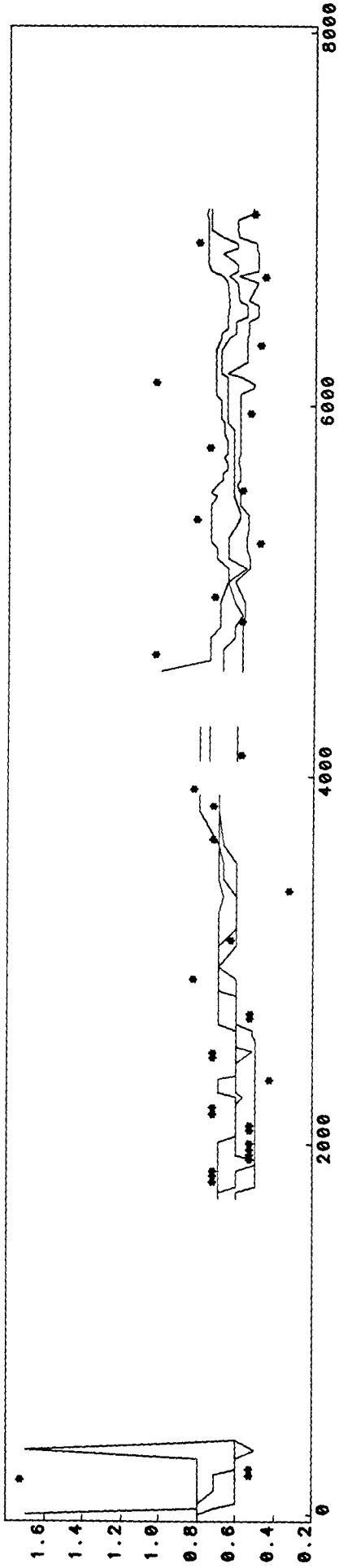

Julian Day  
River no 9 Magnesium

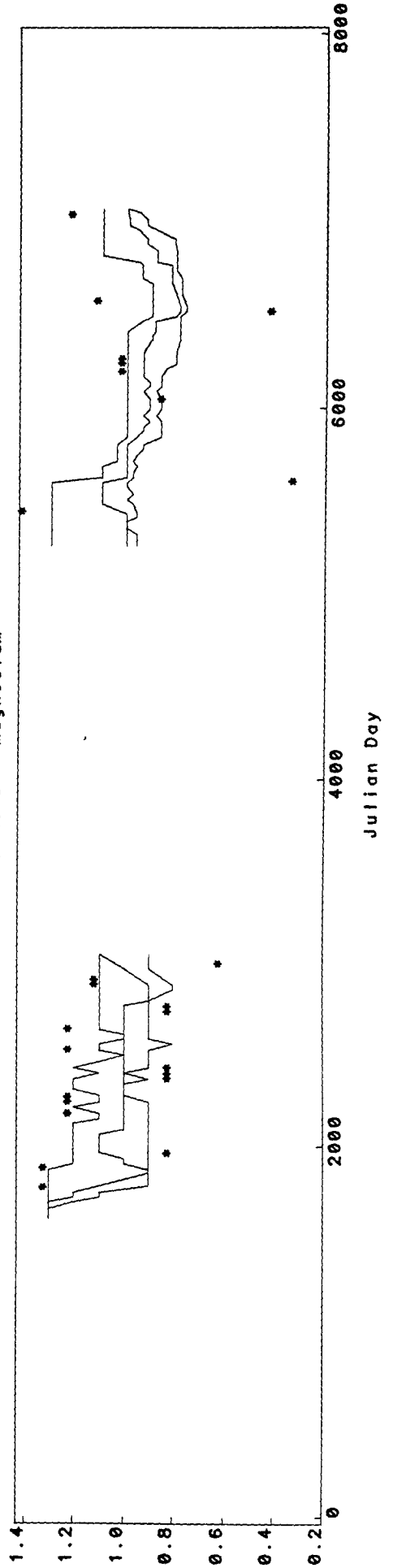

River no 10 Magnesium

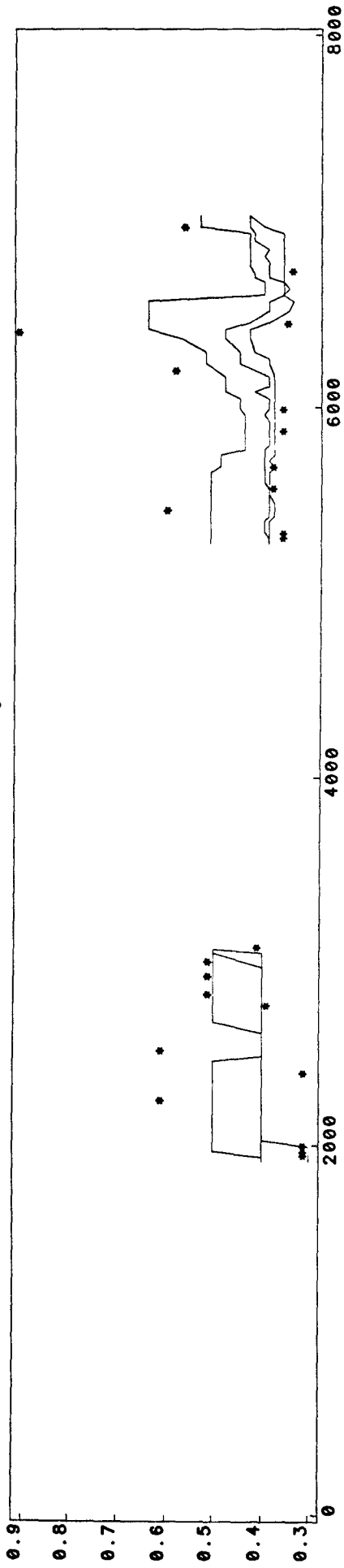

River no 11 Magnesium

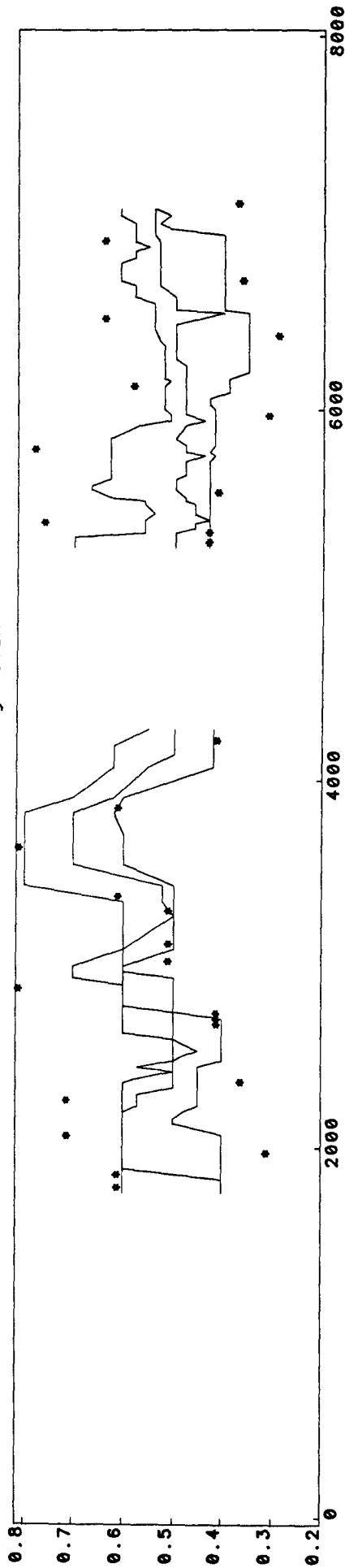

River no 12 Magnesium

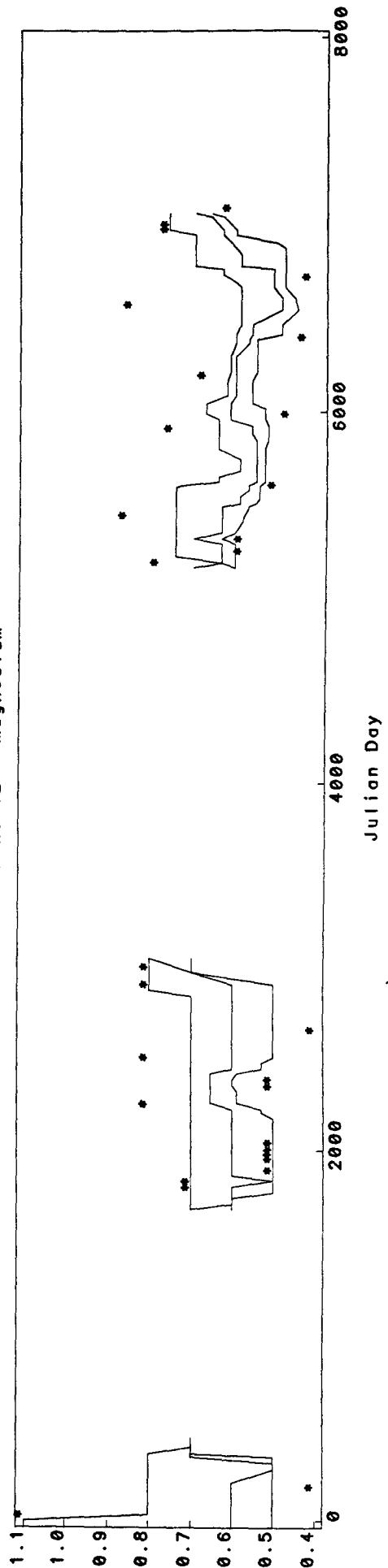

River no 13 Magnesium

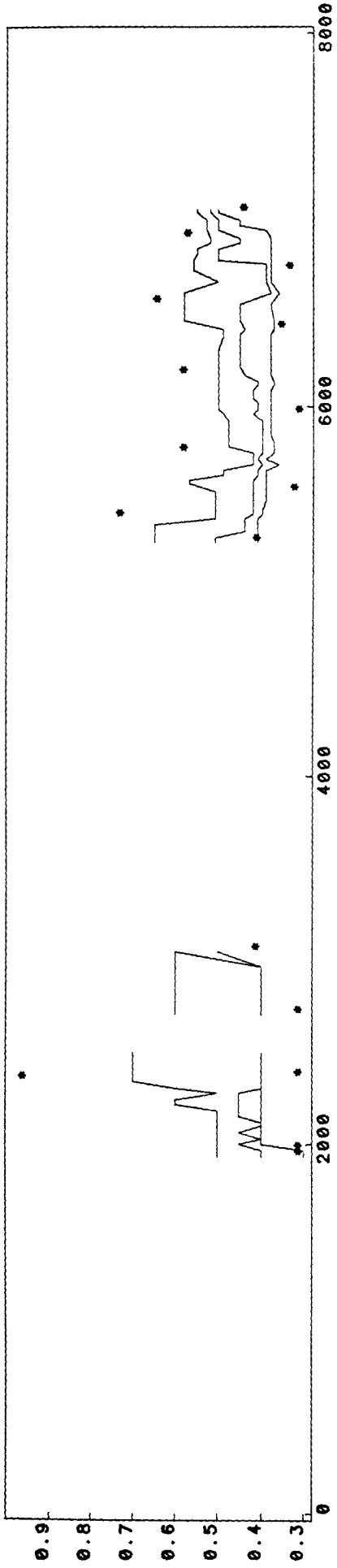

River no 16 Magnesium

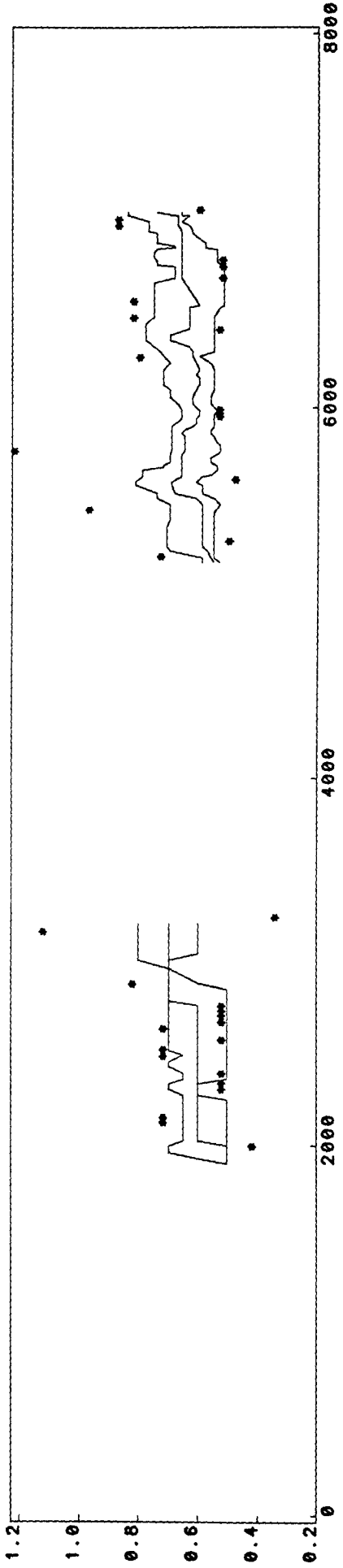

River no 17 Magnesium

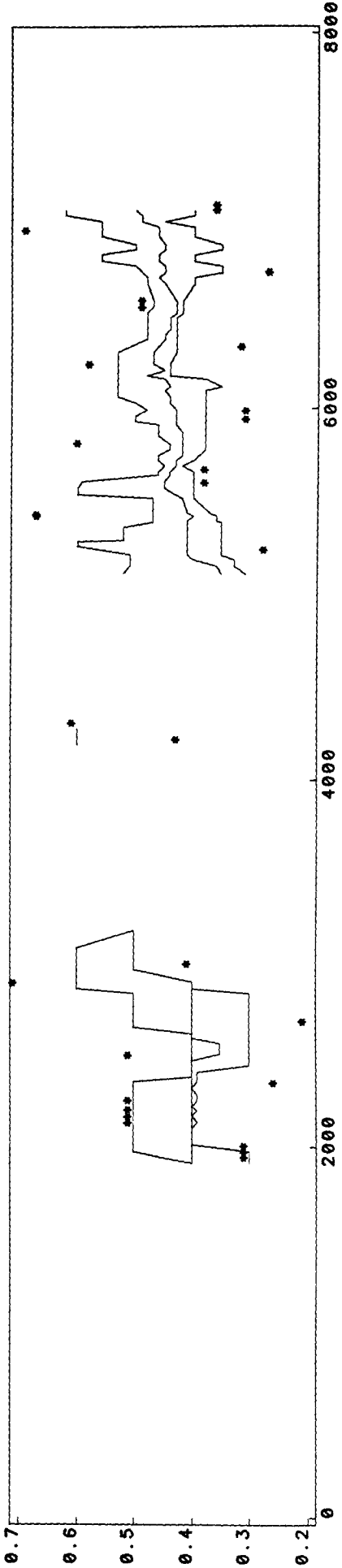

River no 18 Magnesium

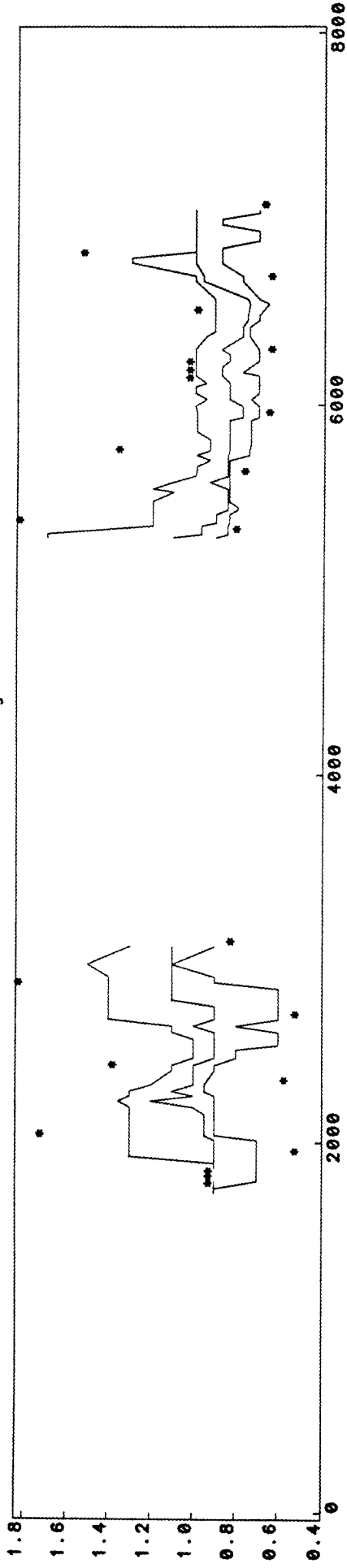

Julian Day  
River no 19 Magnesium

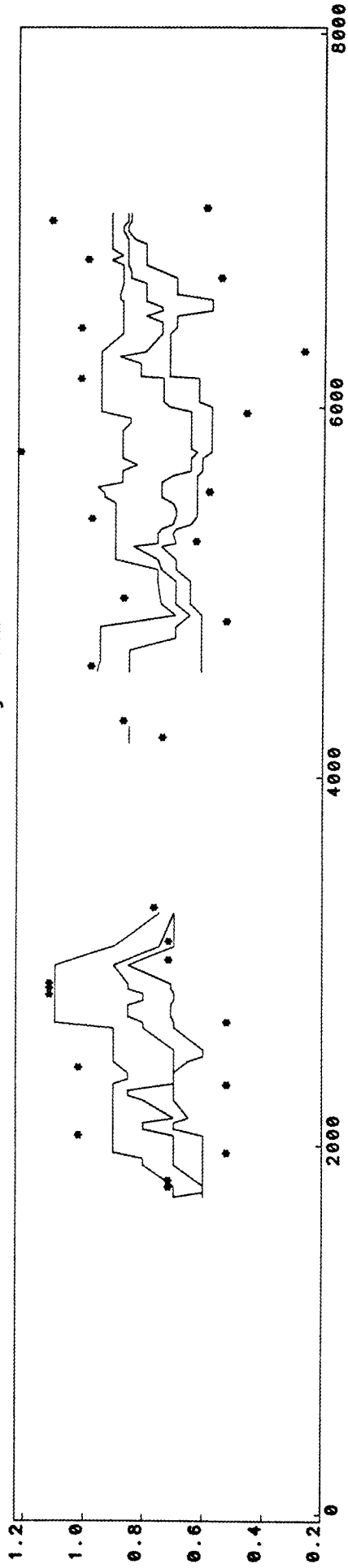

Julian Day  
River no 20 Magnesium

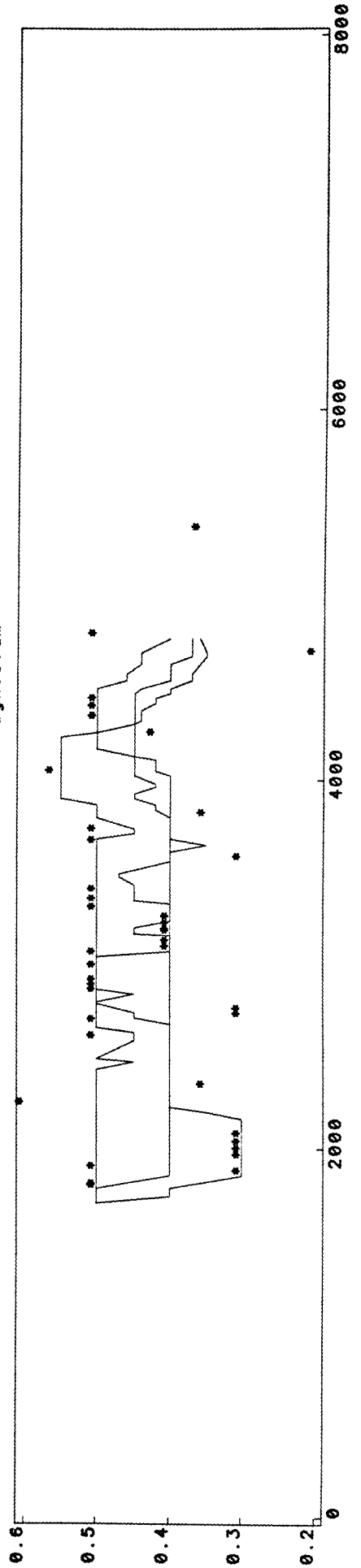

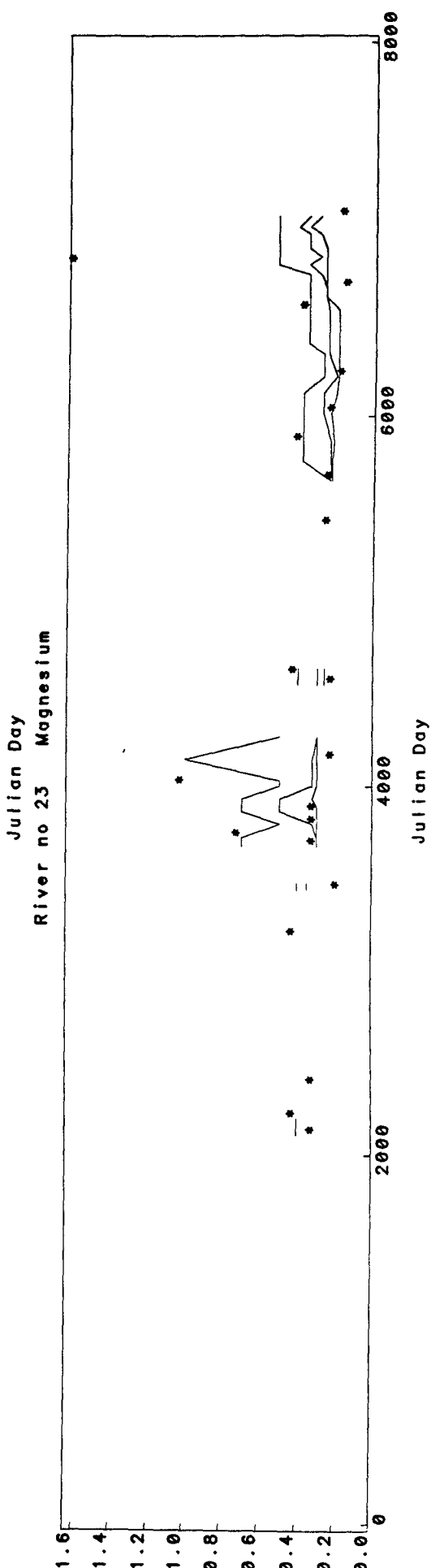
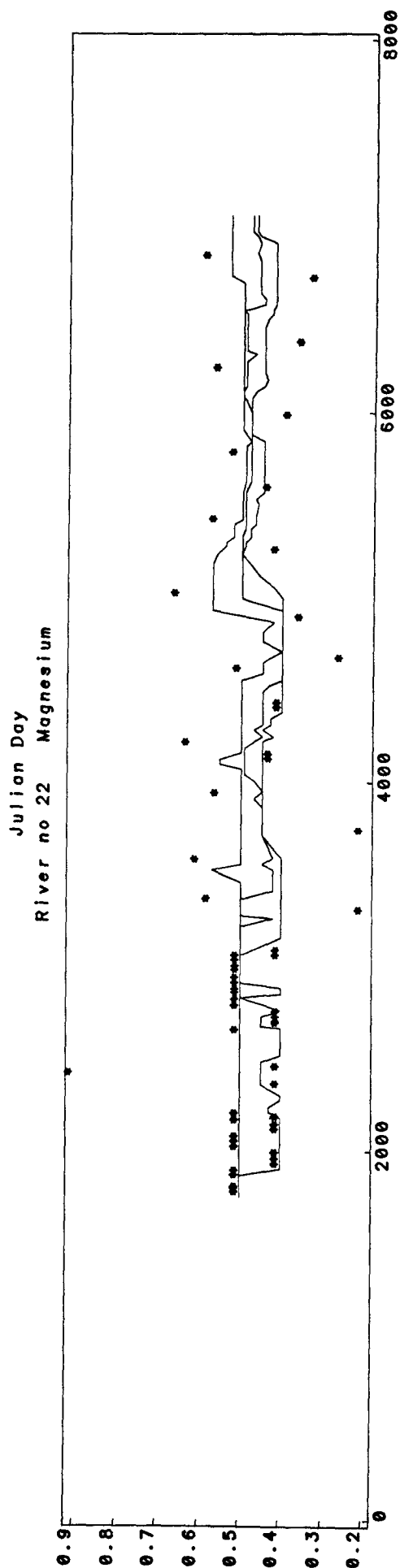
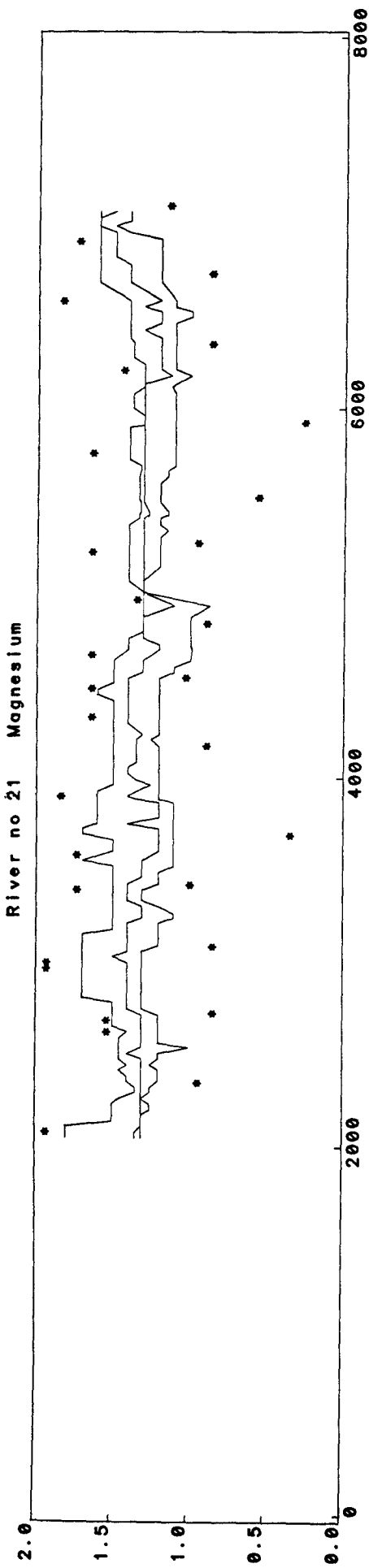

River no 25 Magnesium

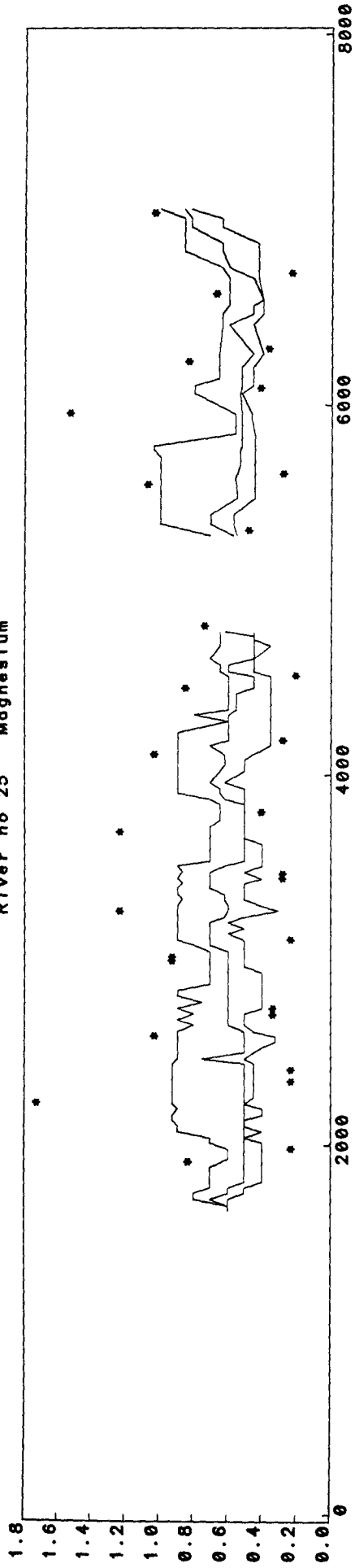

Julian Day  
River no 26 Magnesium

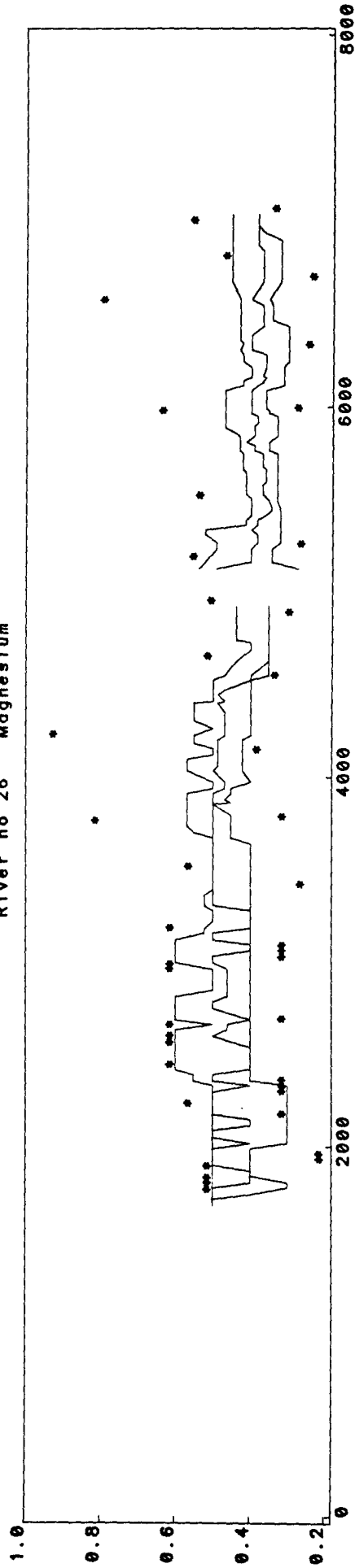

Julian Day  
River no 27 Magnesium

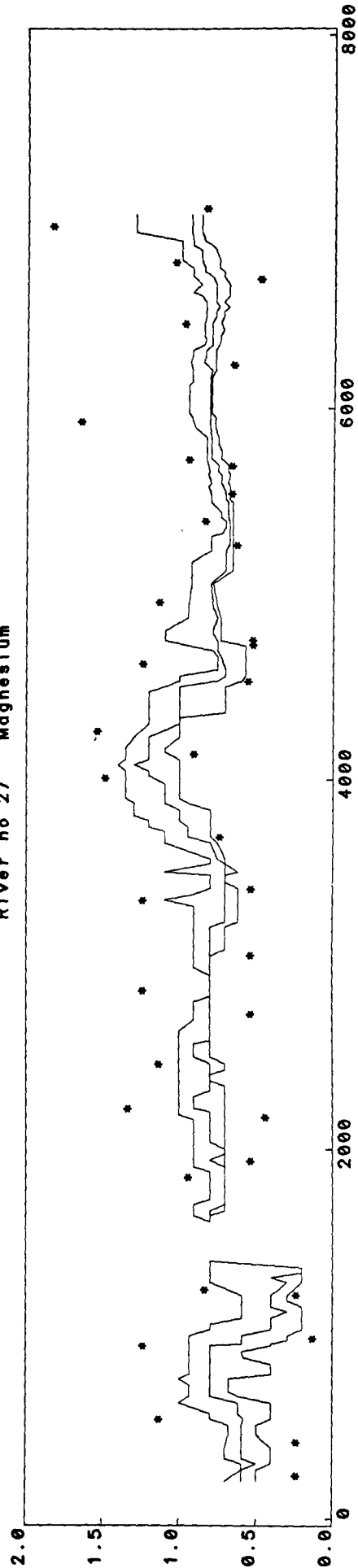

River no 28 Magnesium

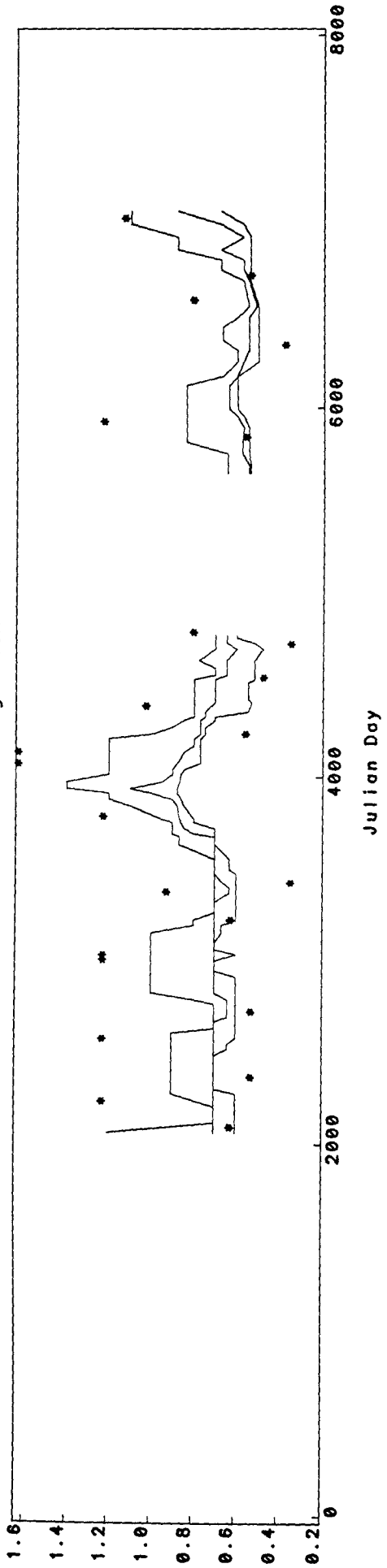

Appendix 15. Running boxplots of conductivity for the study rivers.



river no 1 conductivity

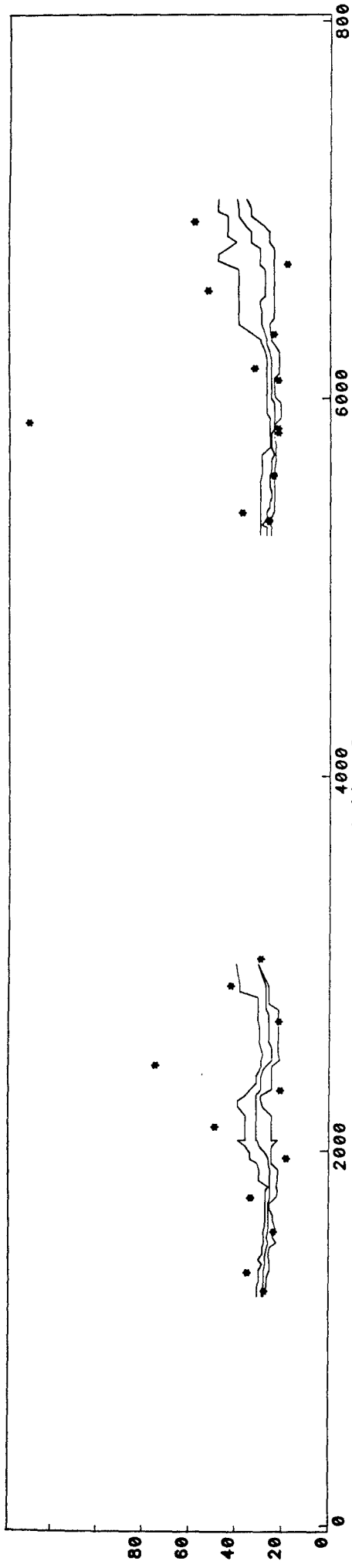

River no 2 Conductivity

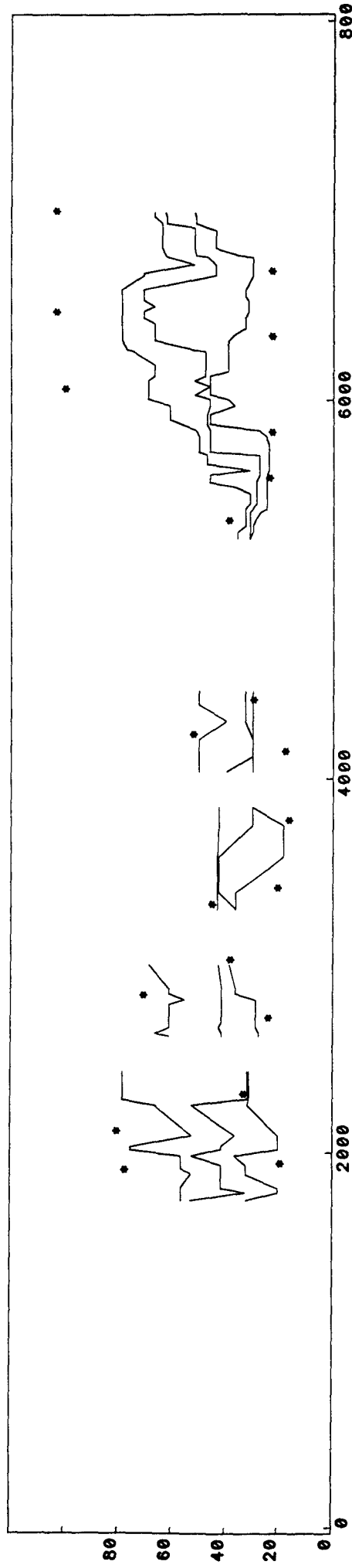

River no 3 Conductivity

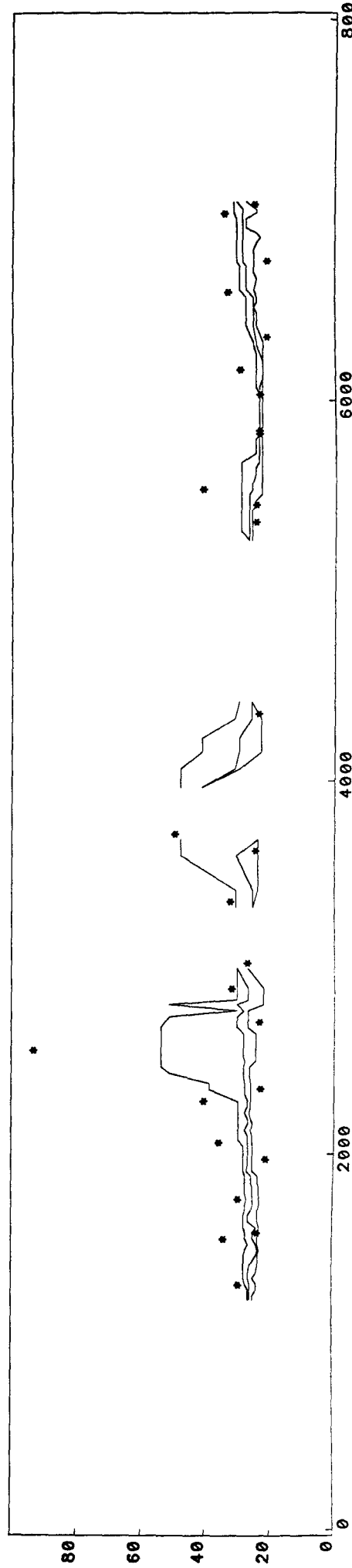

River no + Conductivity

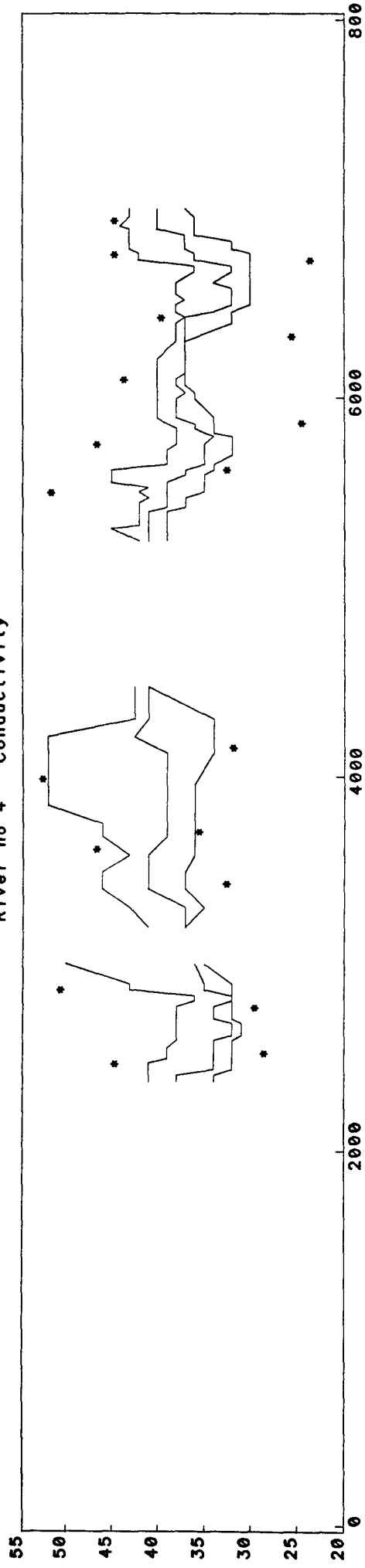

River no 5  
Julian Day  
Conductivity

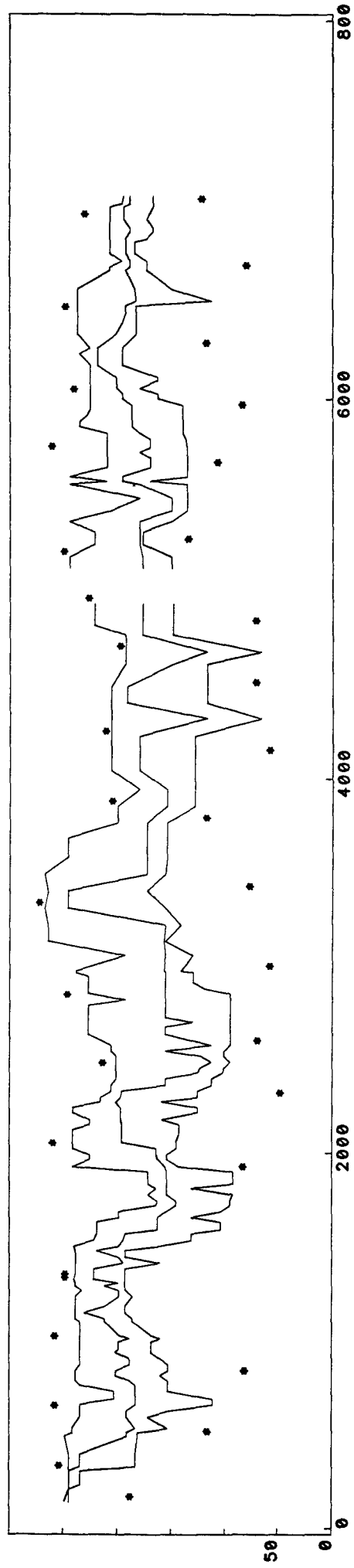

River no 6  
Julian Day  
Conductivity

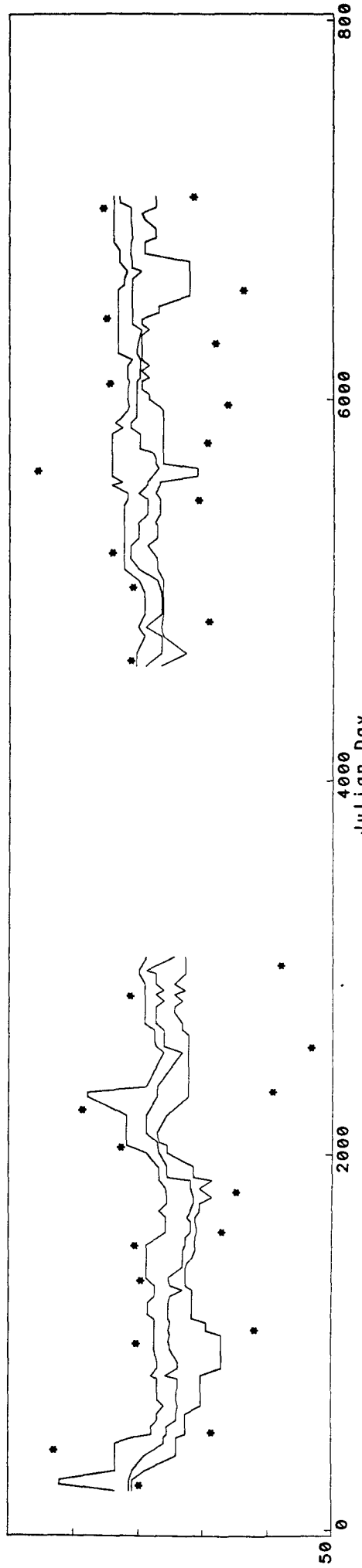

River no 6  
Julian Day  
Conductivity

River no 7 Conductivity

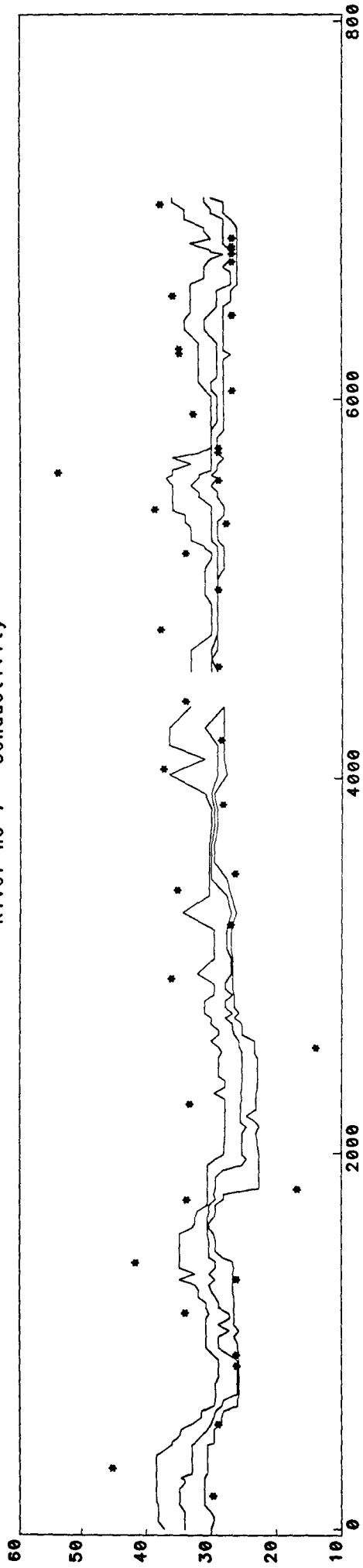

River no 8 Conductivity

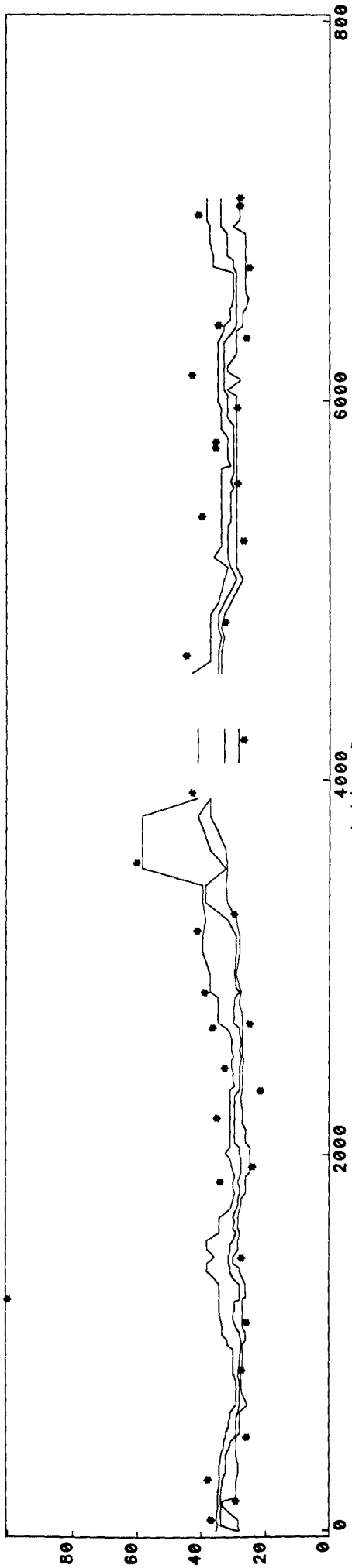

River no 9 Conductivity

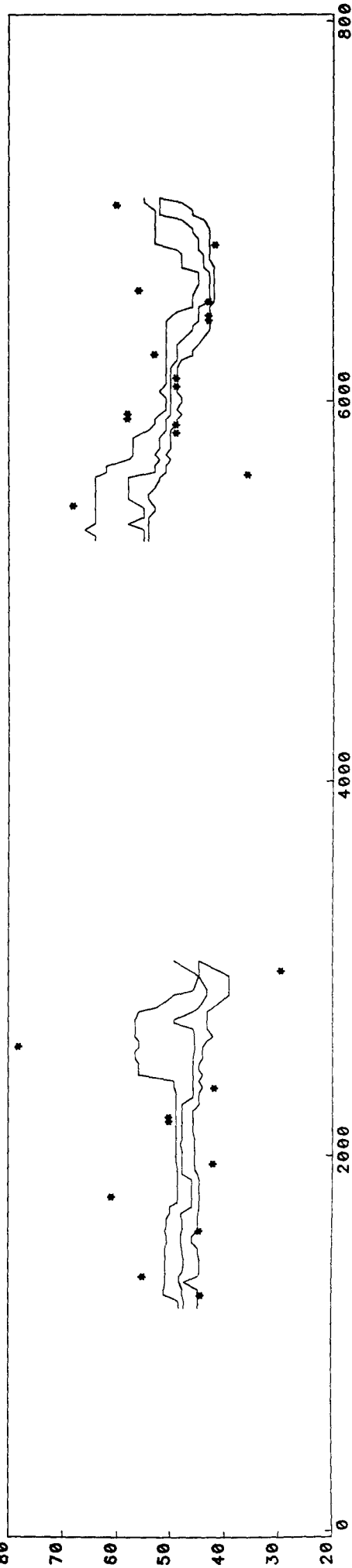

River no 1w Conductivity

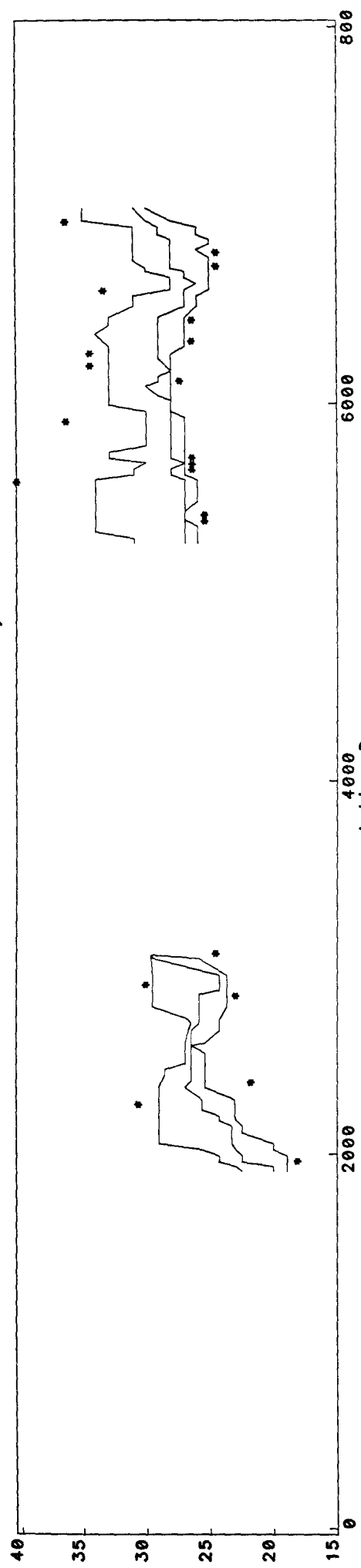

River no 11 Conductivity

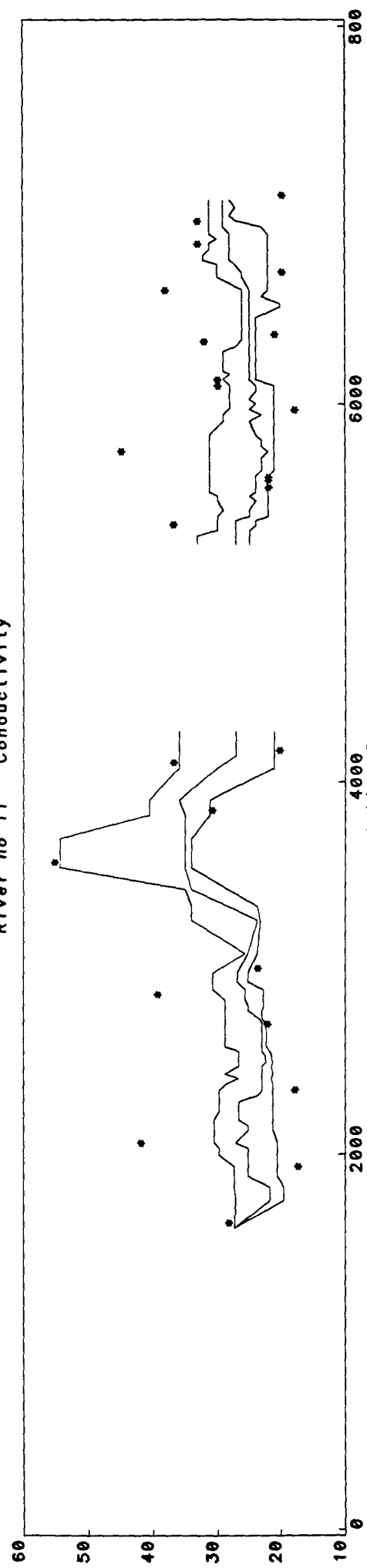

River no 12 Conductivity

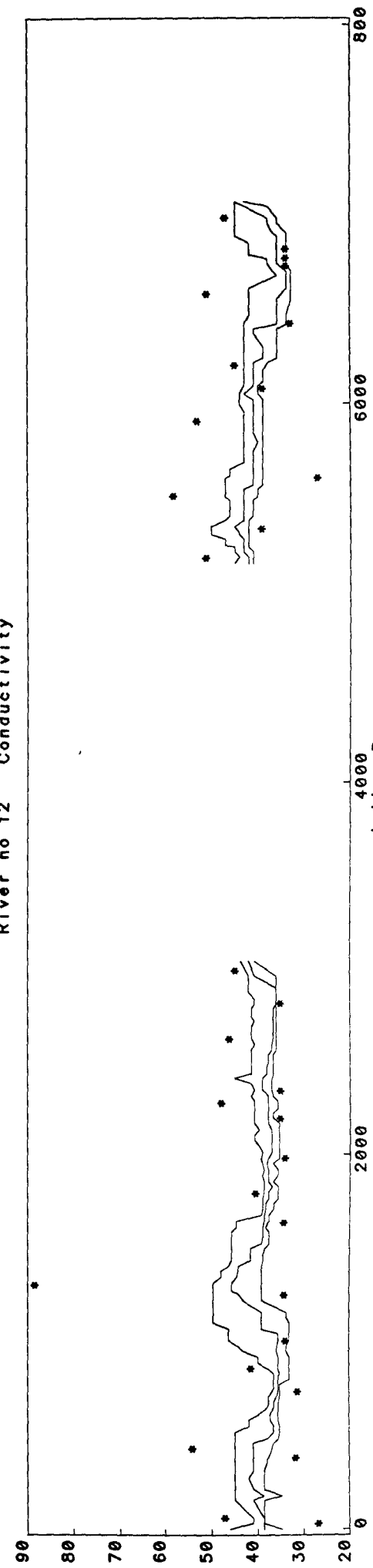

River no 15 Conductivity

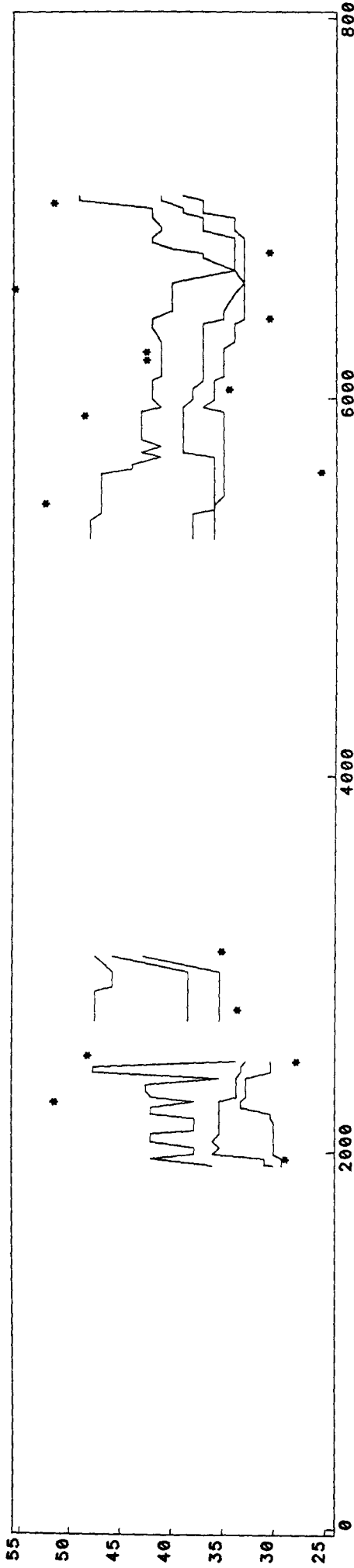

River no 16 Conductivity

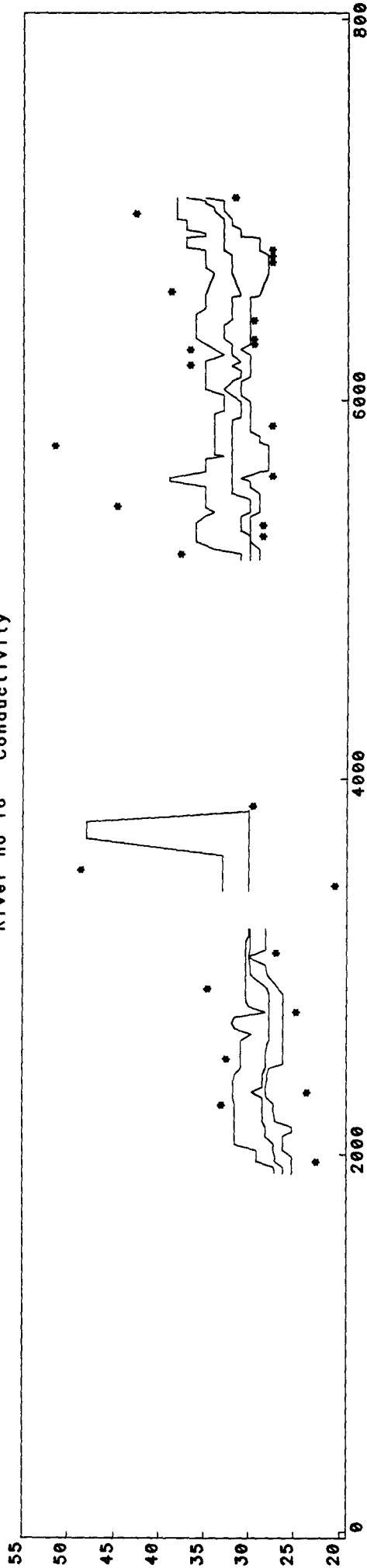

River no 17 Conductivity

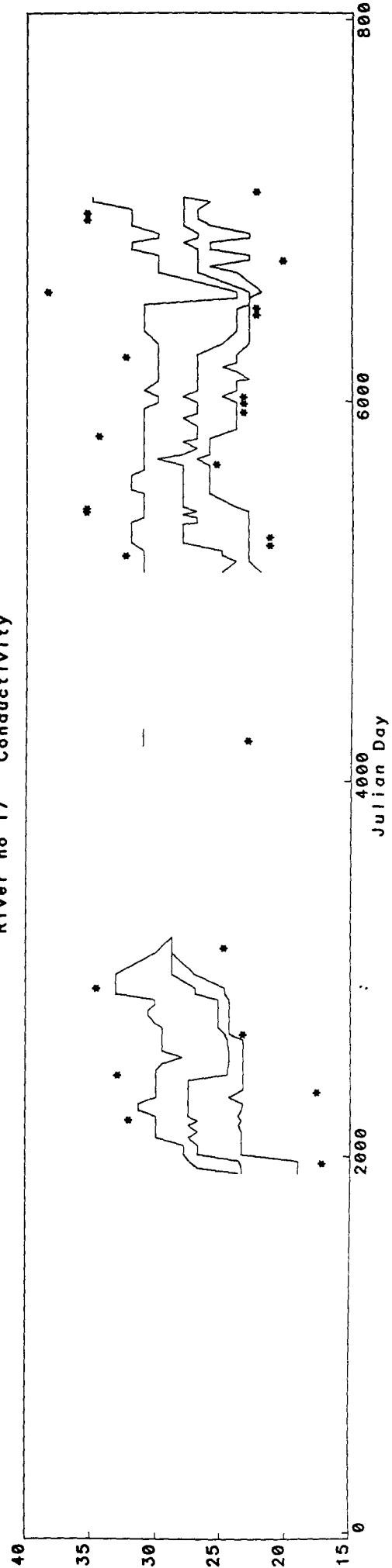

River no 18 Conductivity

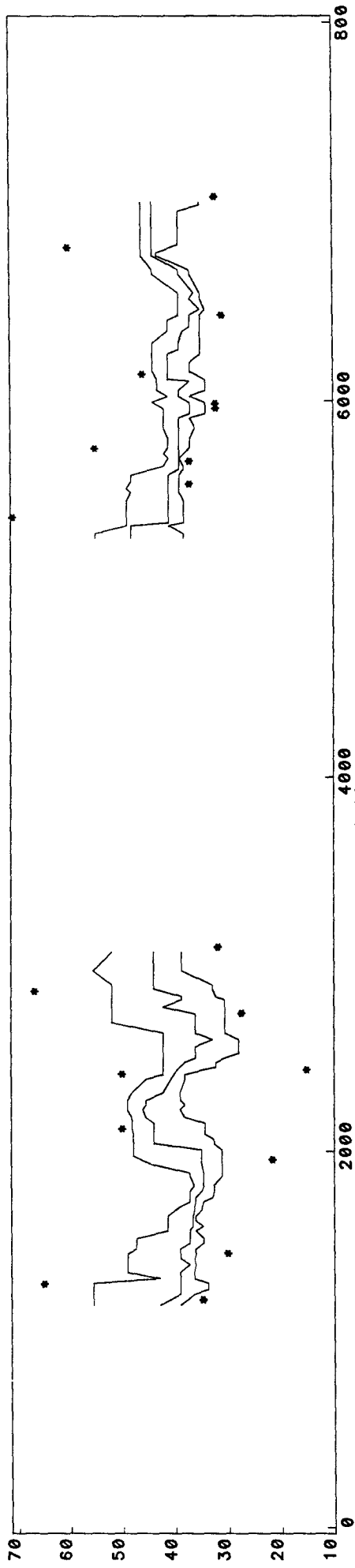

River no 19 Conductivity

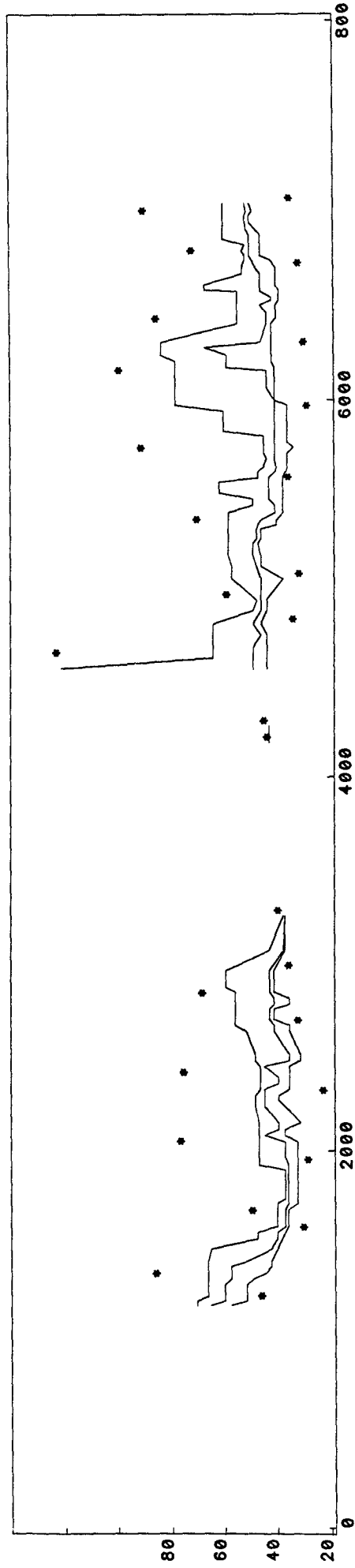

River no 20 Conductivity

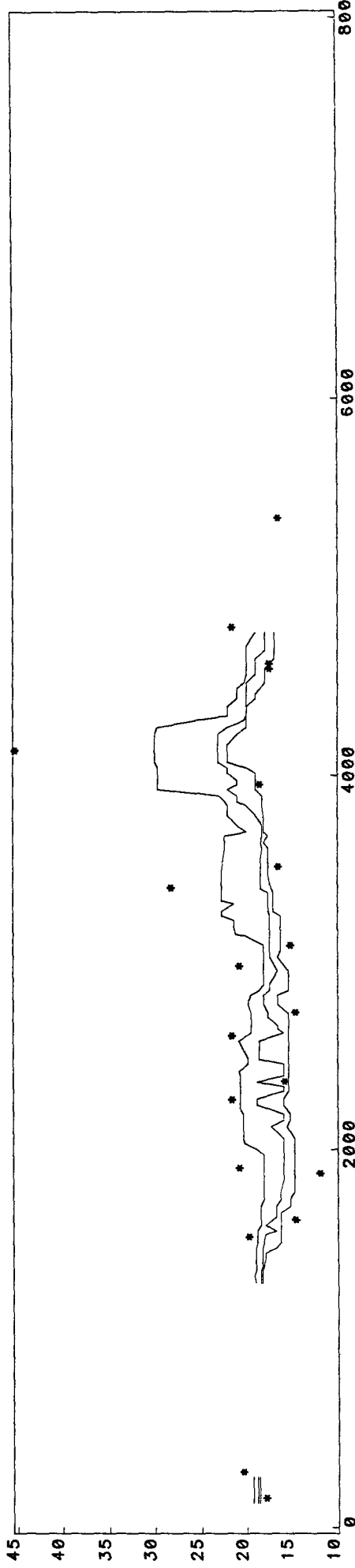

River no 21 Conductivity

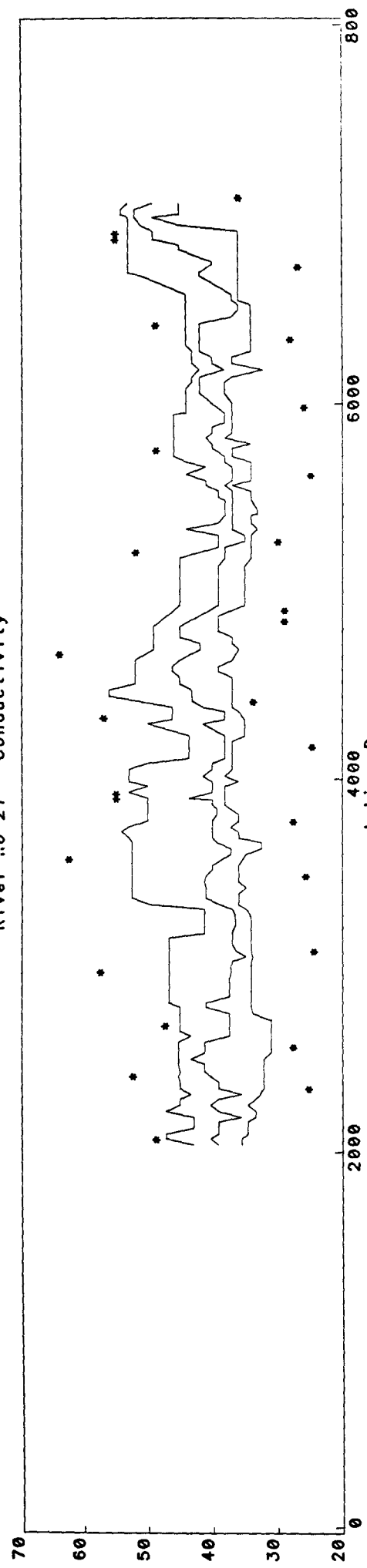

River no 22 Conductivity

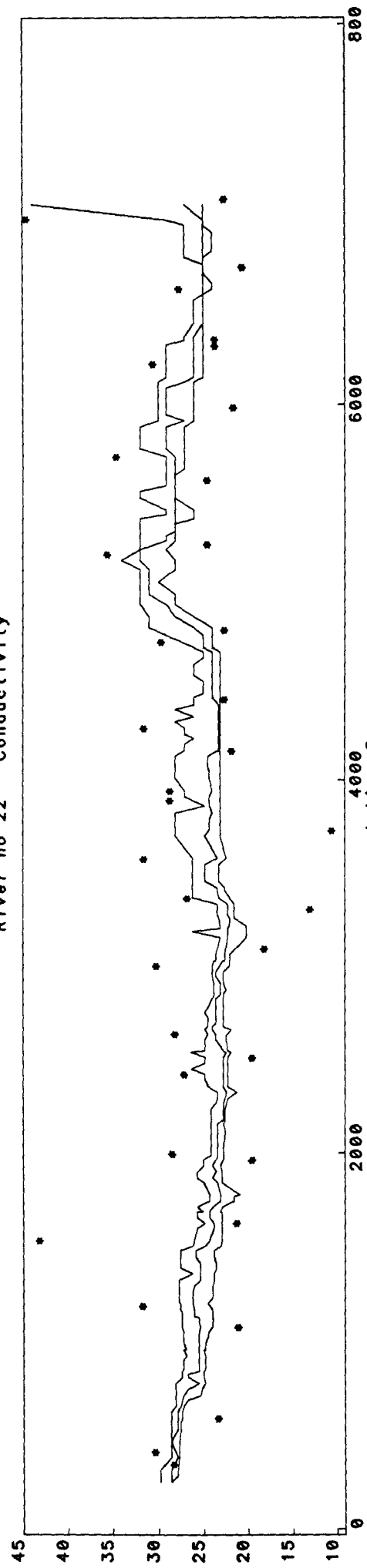

River no 23 Conductivity

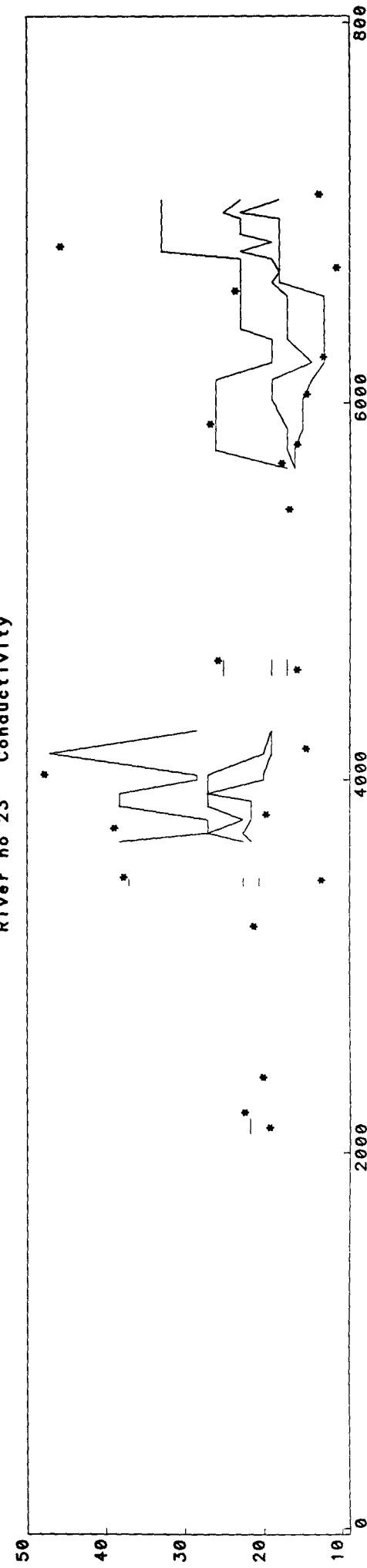

River no 25 Conductivity

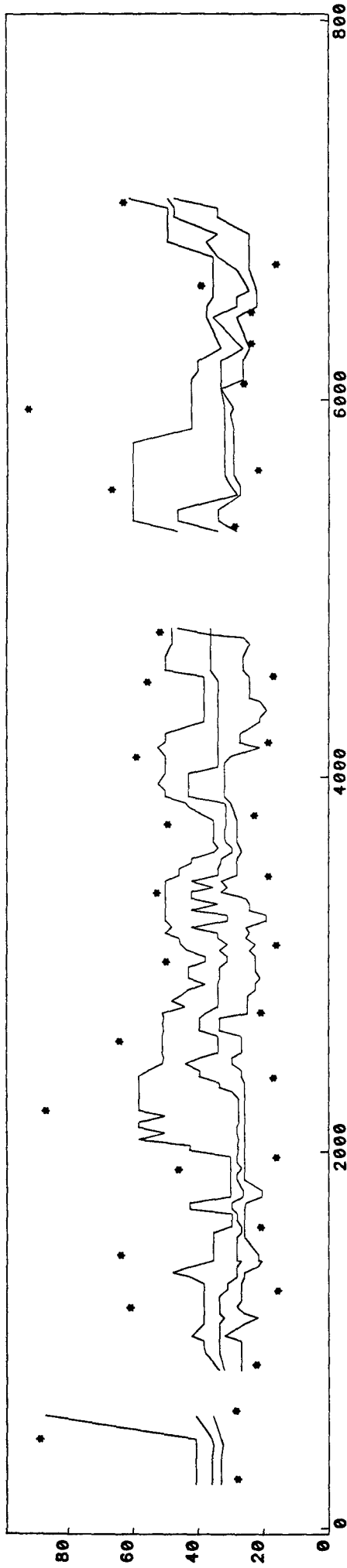

River no 26 Conductivity

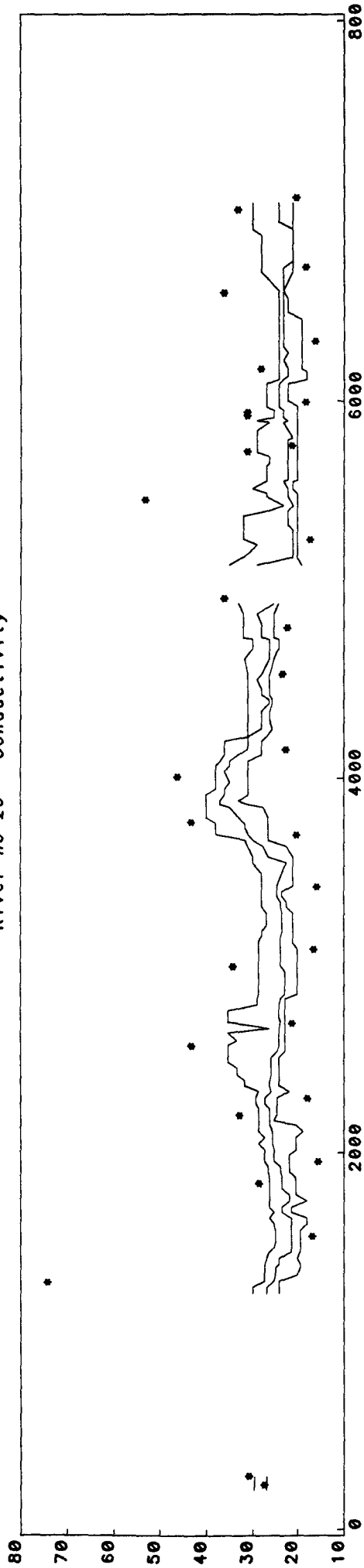

River no 27 Conductivity

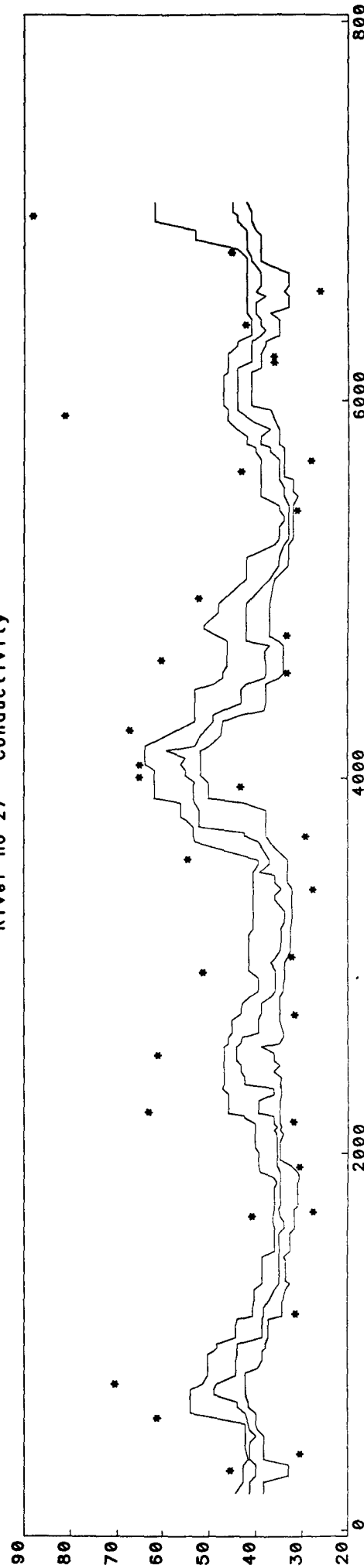



River no 28 Conductivity

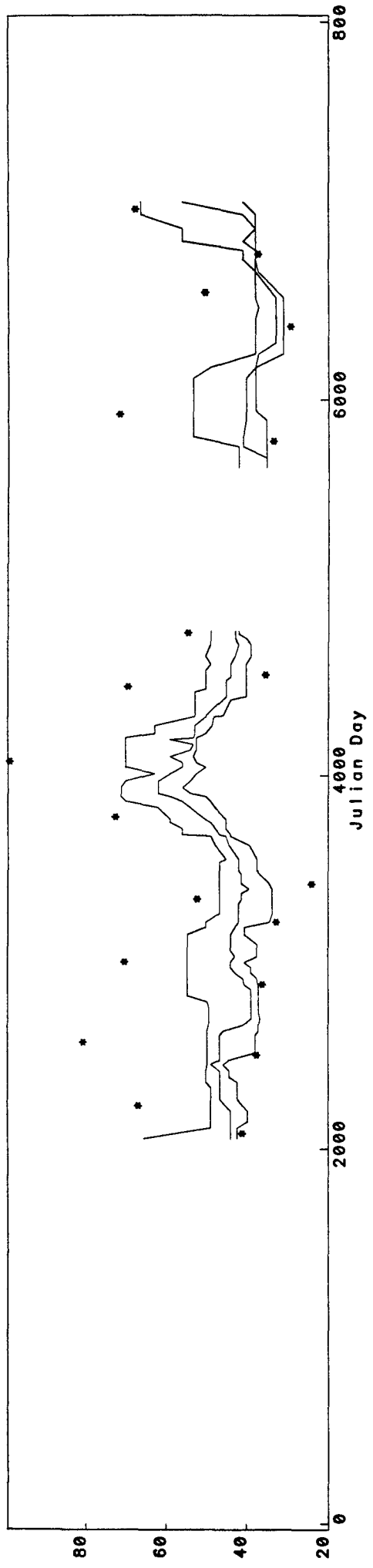

Appendix 16. Running boxplots of colour for the study rivers.

River no 1

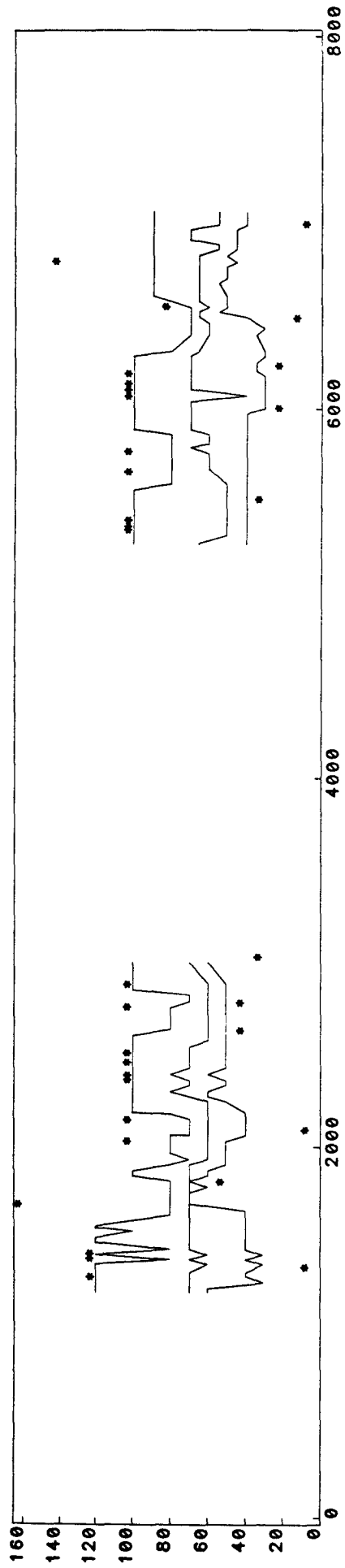

River no 2

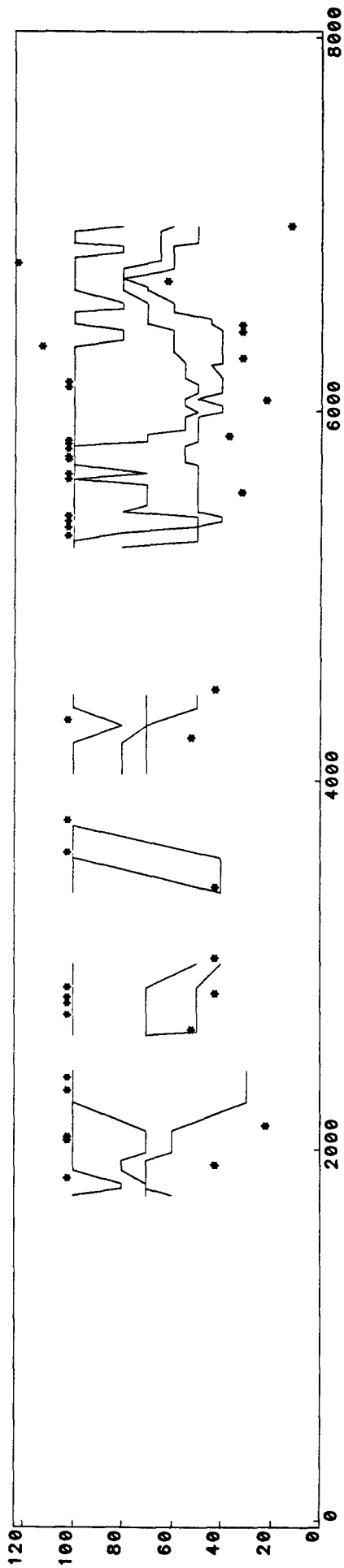

River no 3

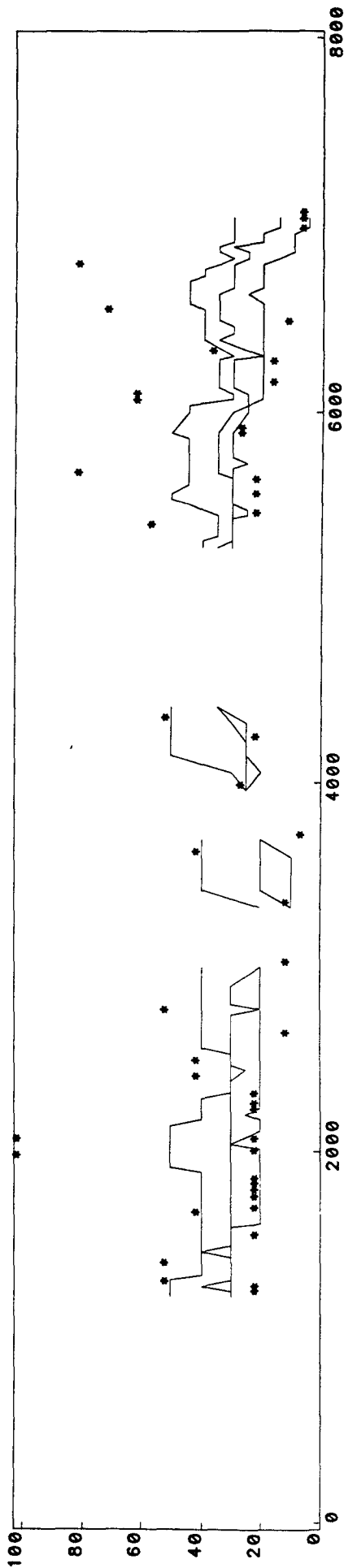

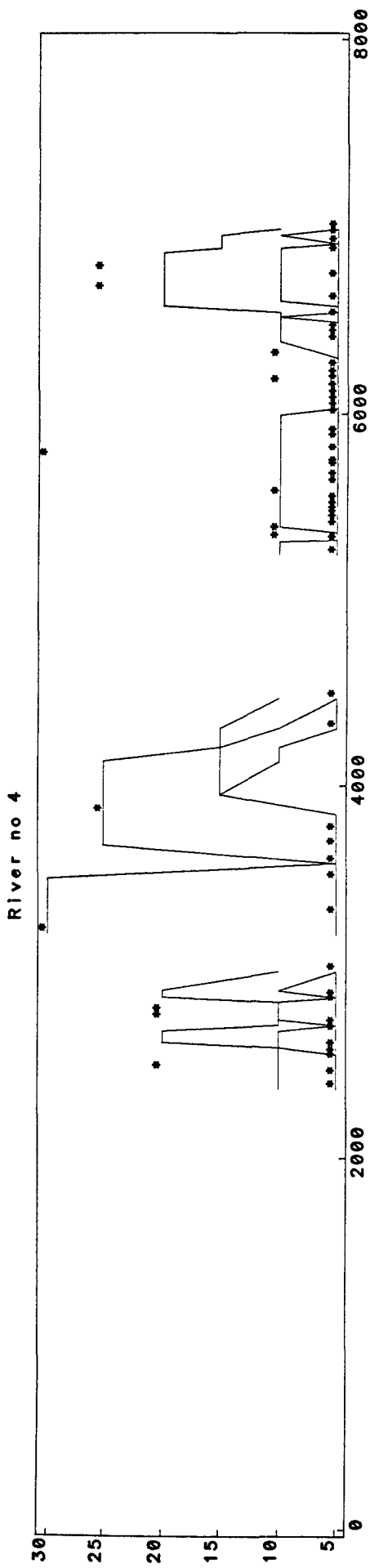

Julian Day  
River no 5

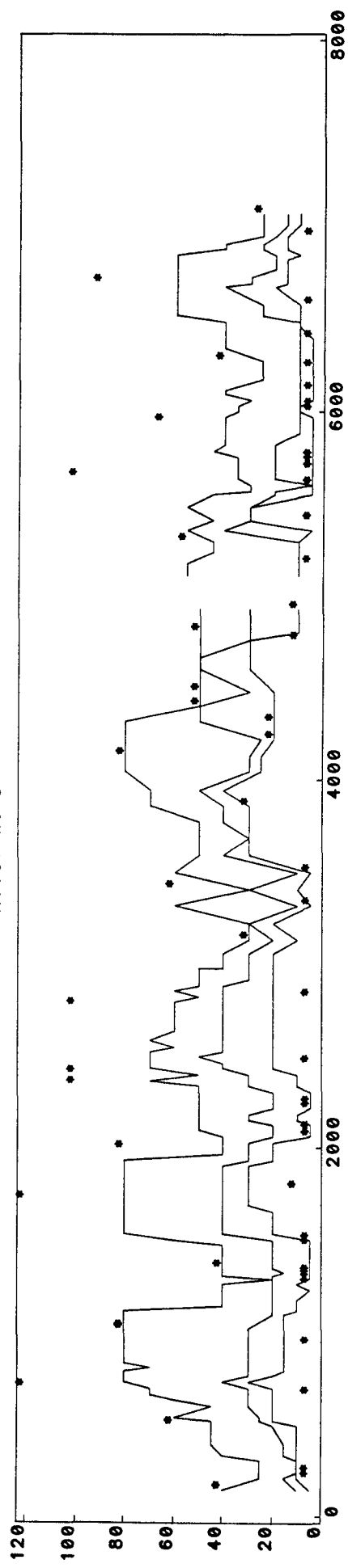

Julian Day  
River no 6

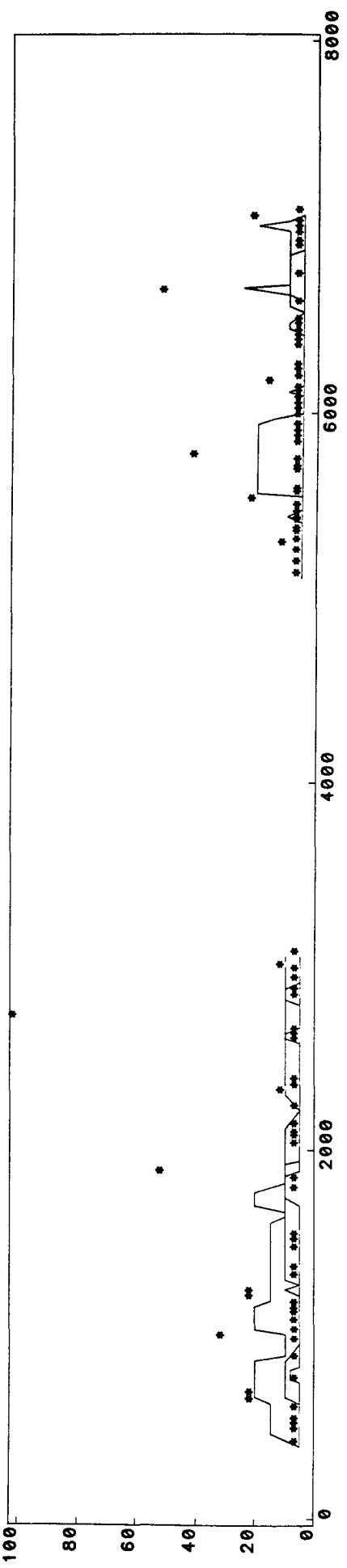

Julian Day

River no 7

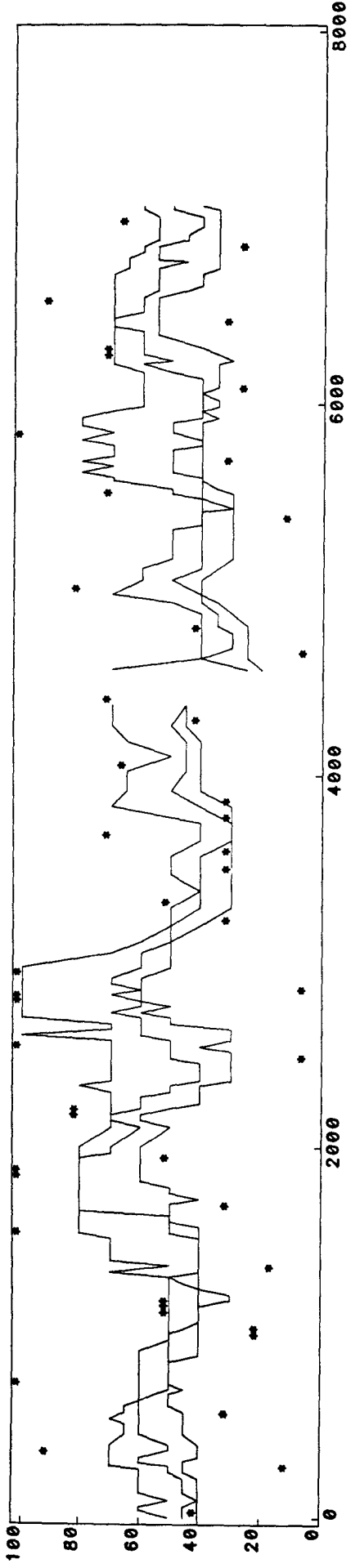

Julian Day  
River no 8

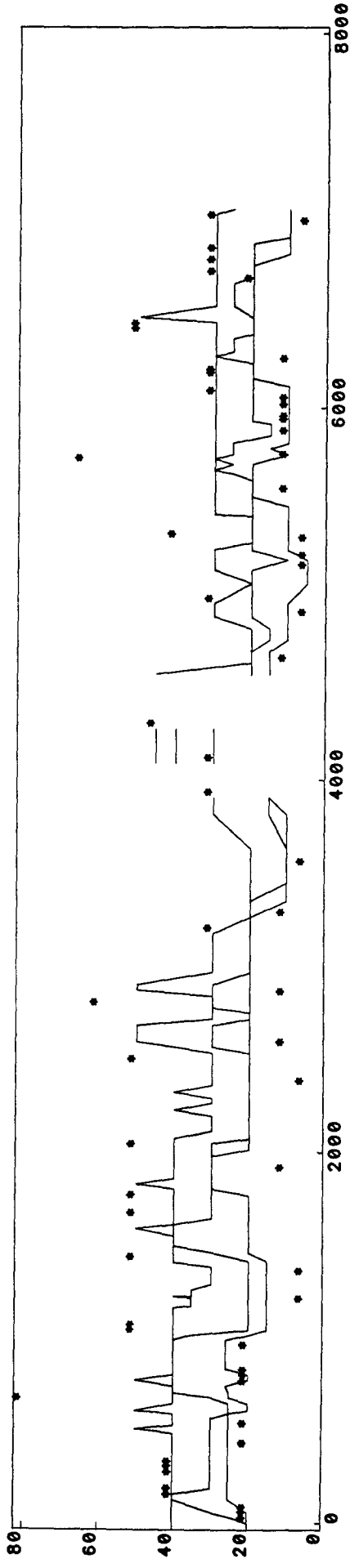

Julian Day  
River no 9

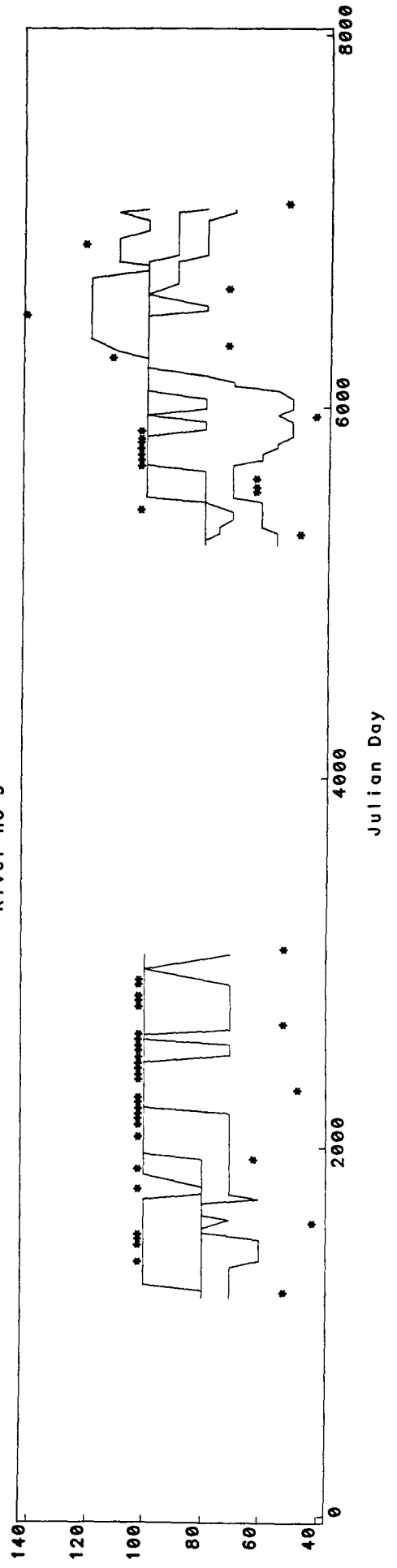

River no 10

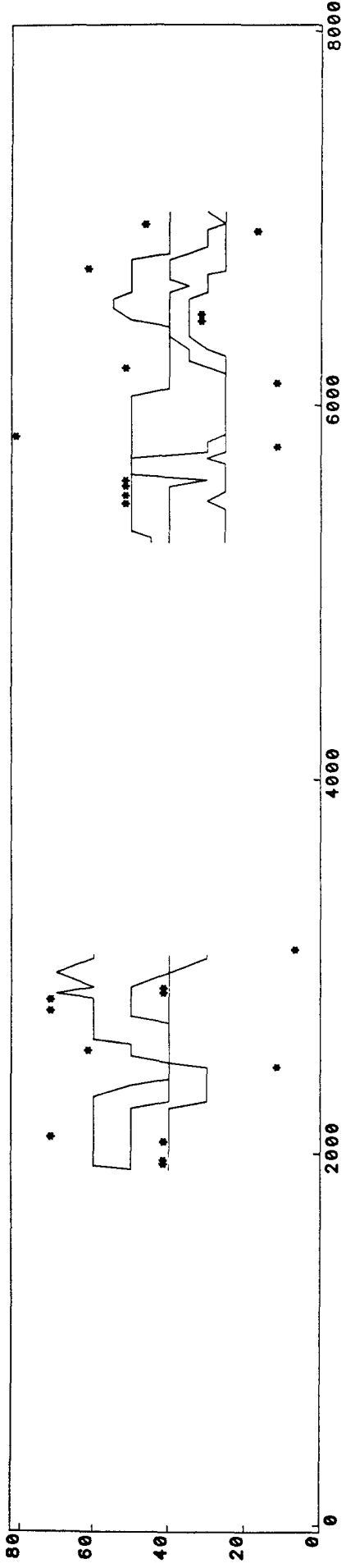

Julian Day  
River no 11

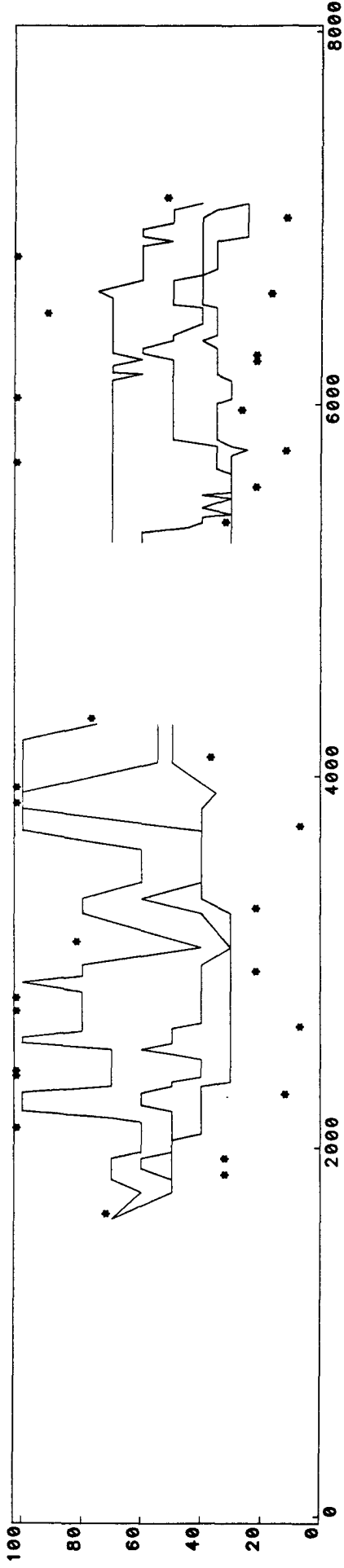

Julian Day  
River no 12

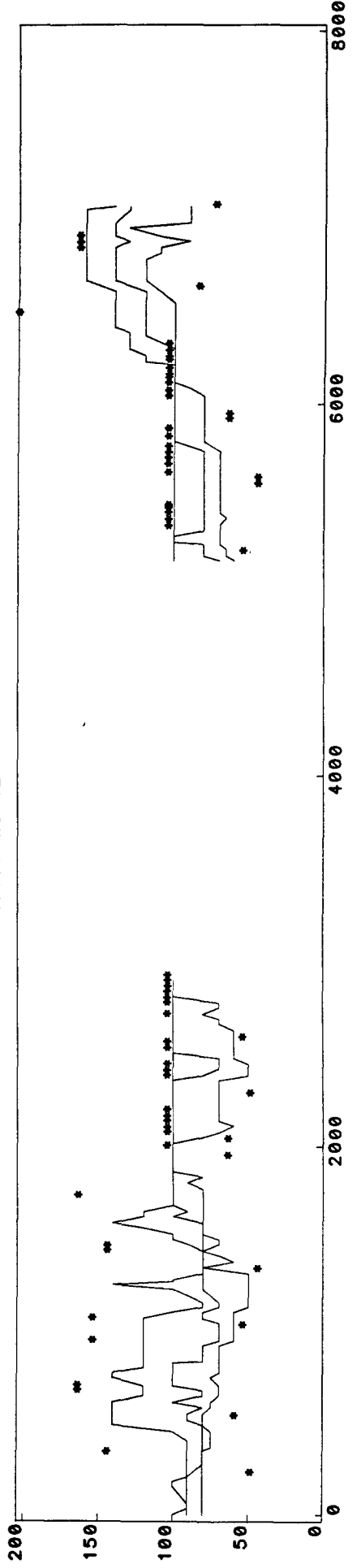

River no 13

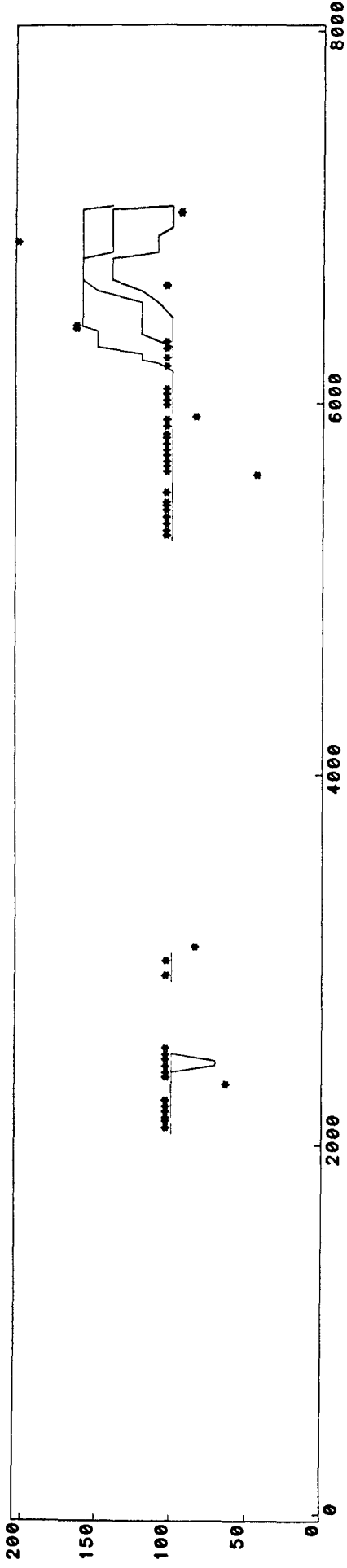

Julian Day  
River no 16

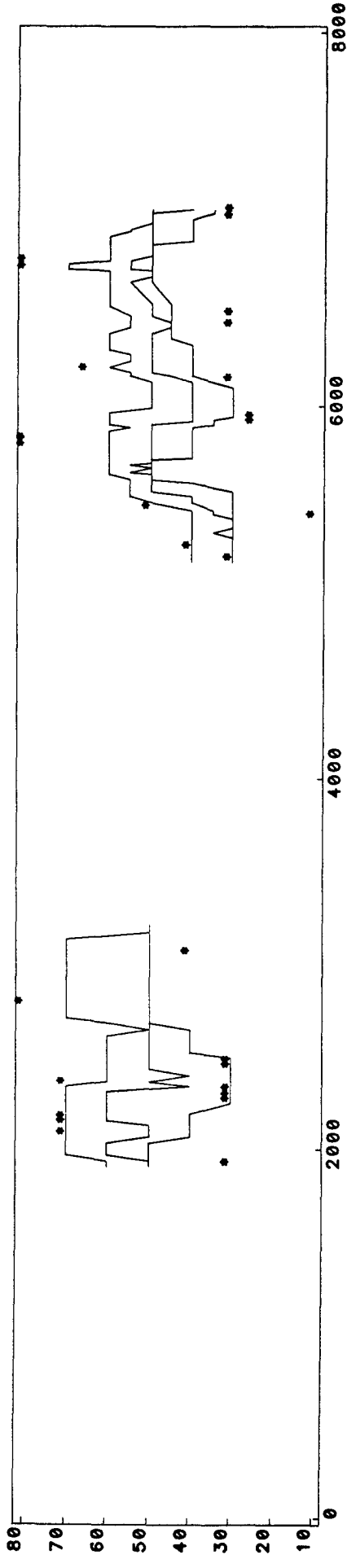

Julian Day  
River no 17

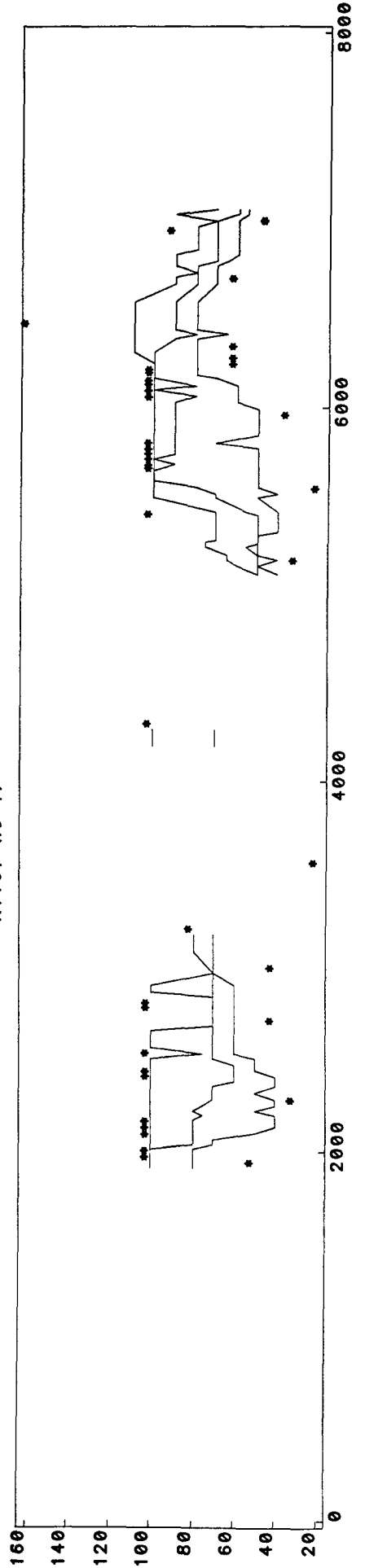

River no 18

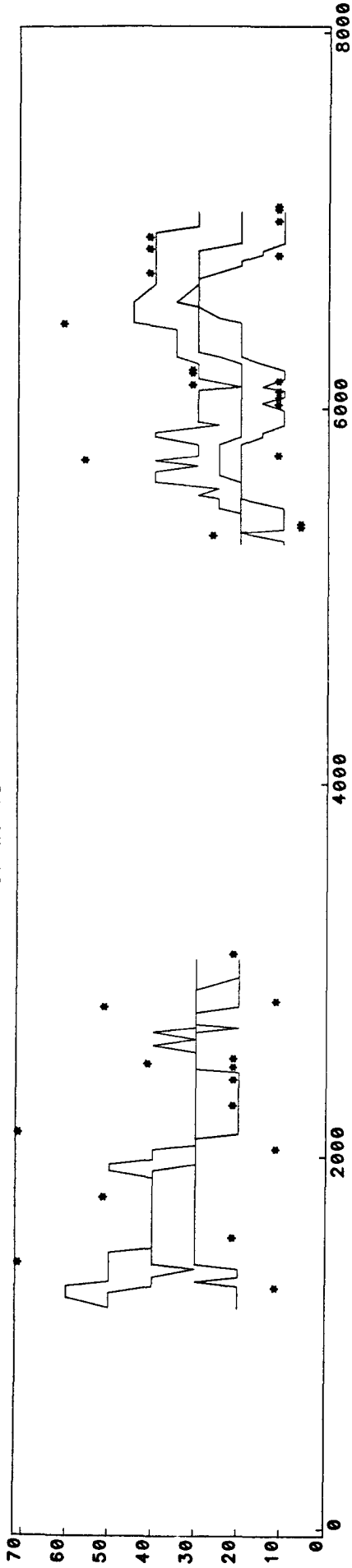

Julian Day  
River no 19

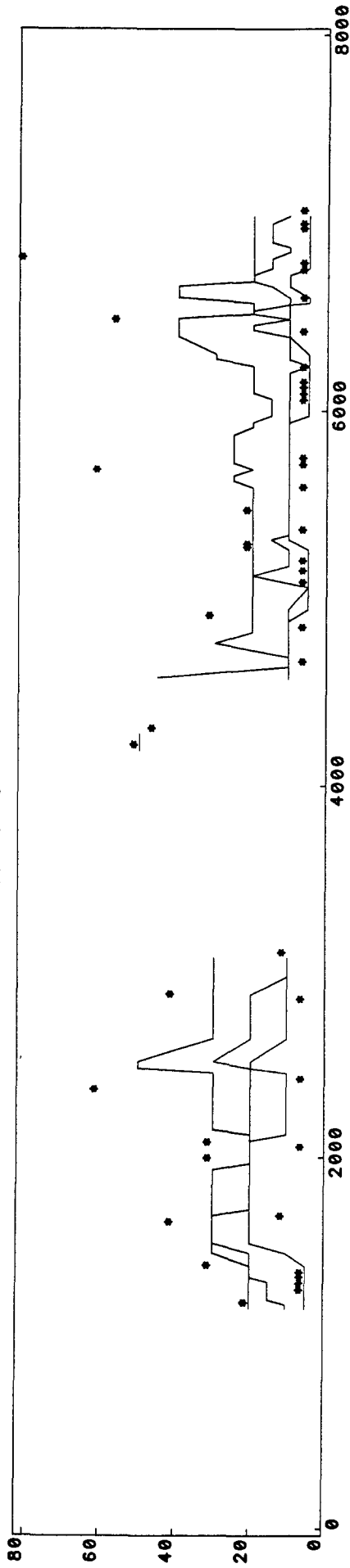

Julian Day  
River no 20

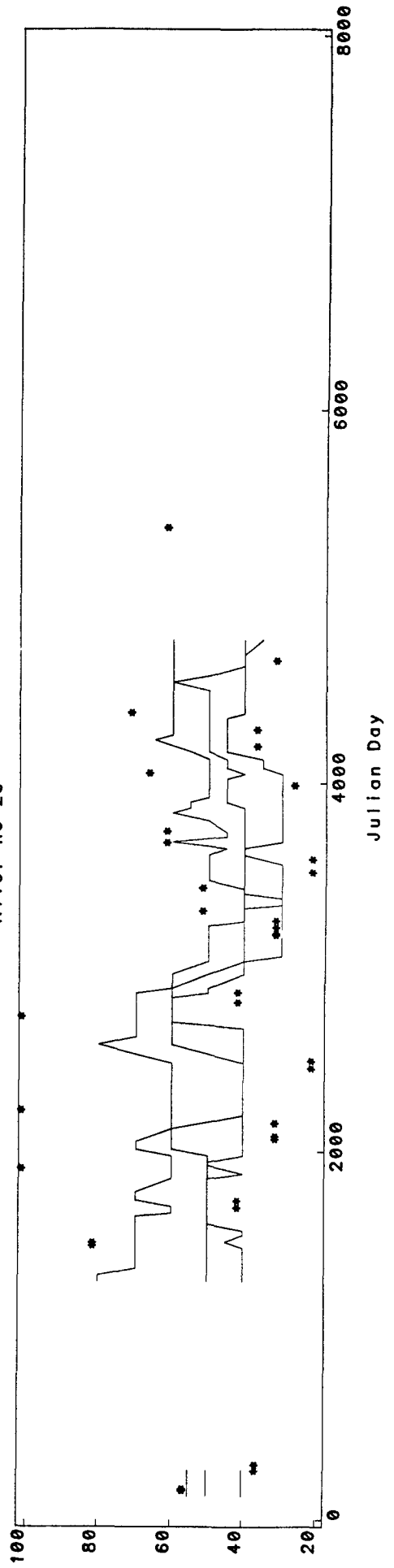



River no 21

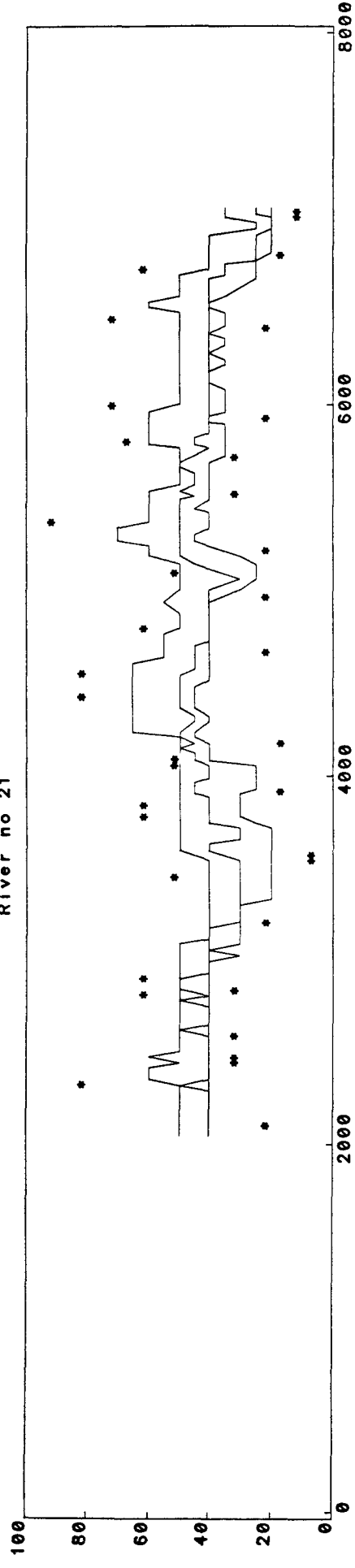

Julian Day

River no 22

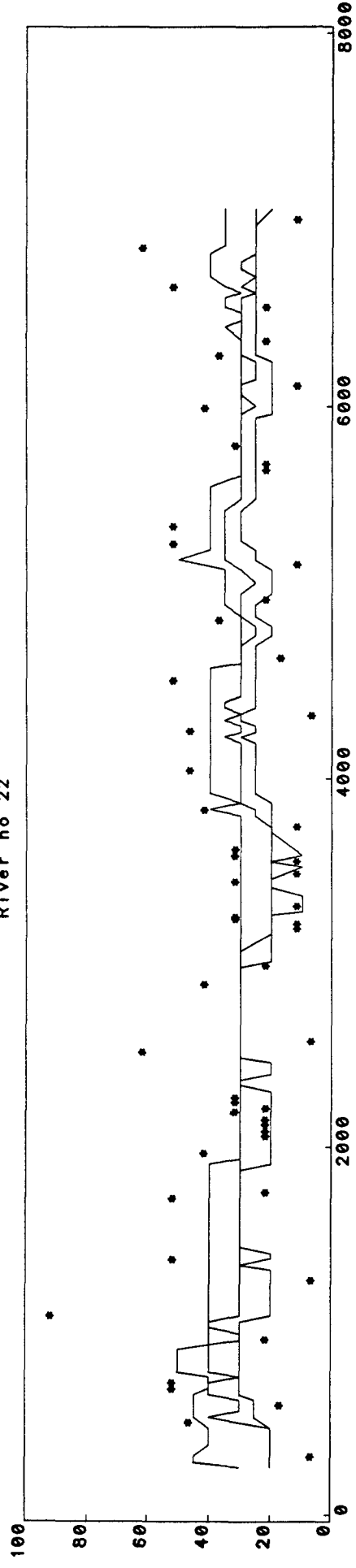

Julian Day

River no 23

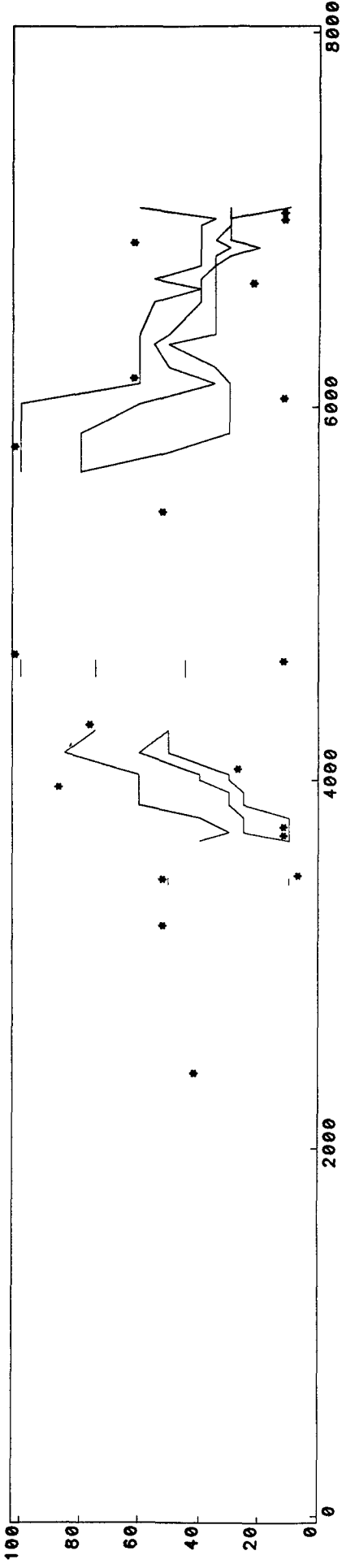

Julian Day

River no 25

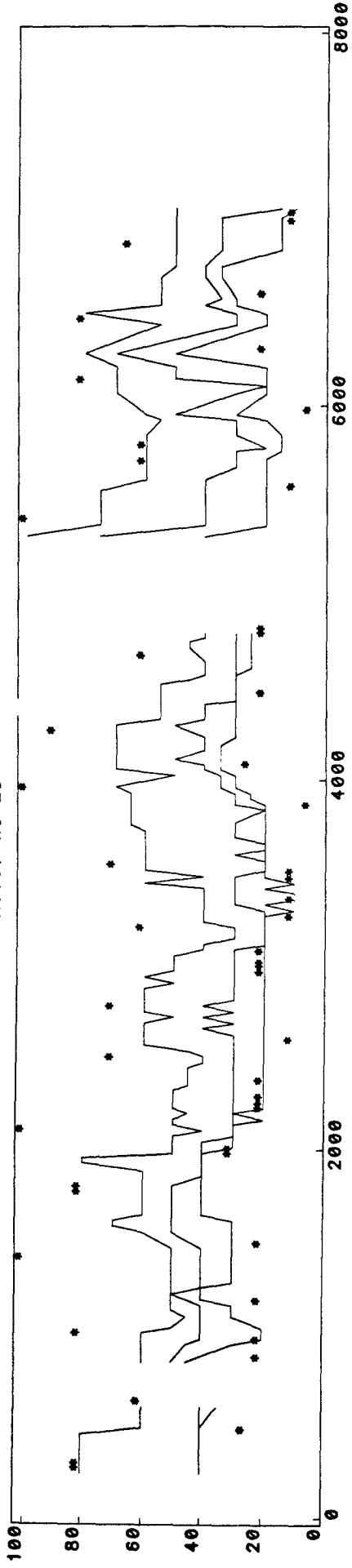

Julian Day

River no 26

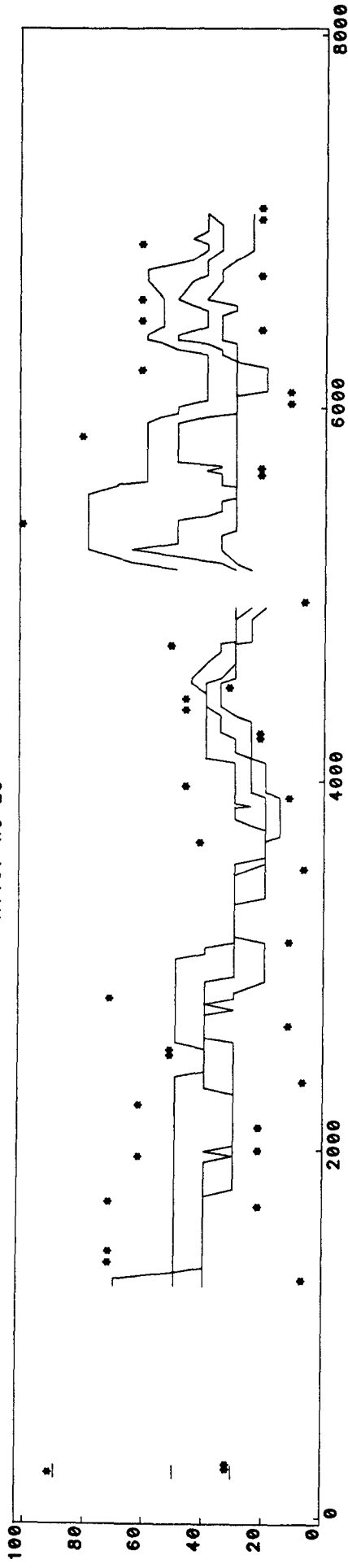

Julian Day

River no 27

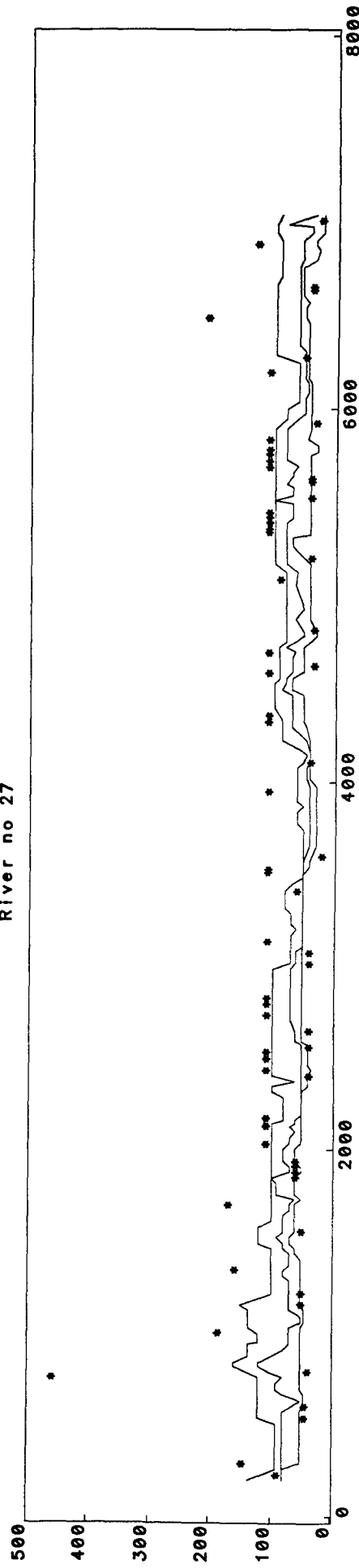

Julian Day

River no 28

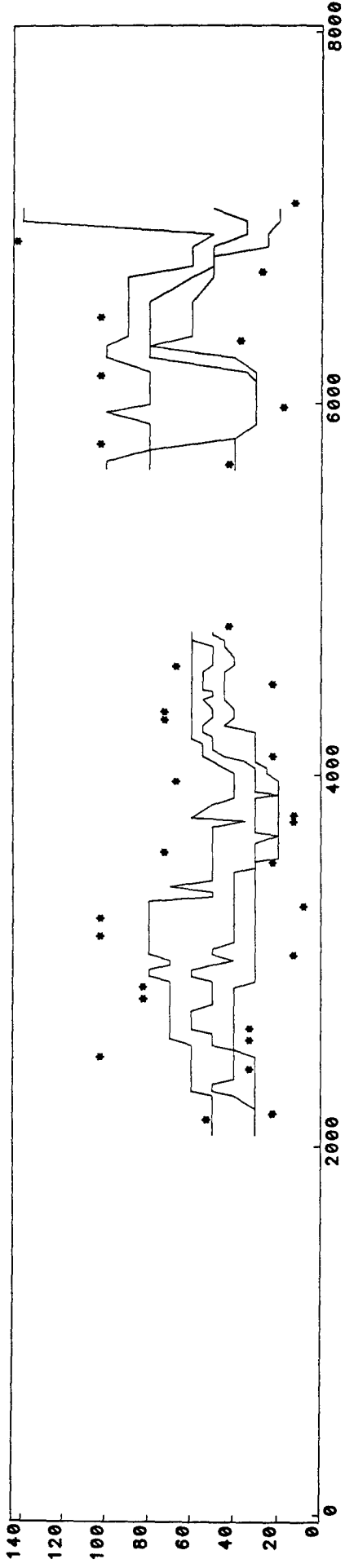

Julian Day

Appendix 17. Running boxplots of turbidity for the study rivers.

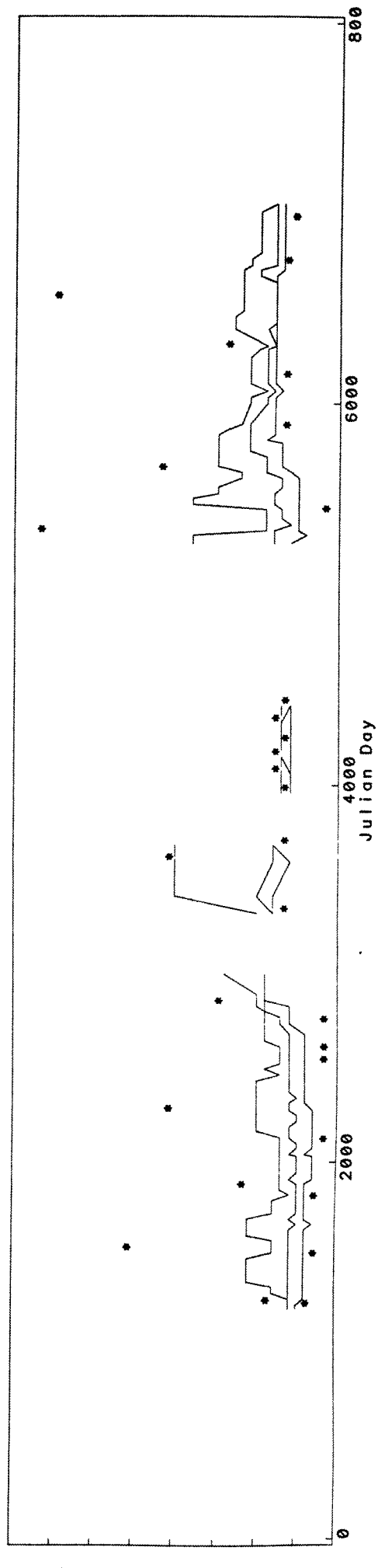
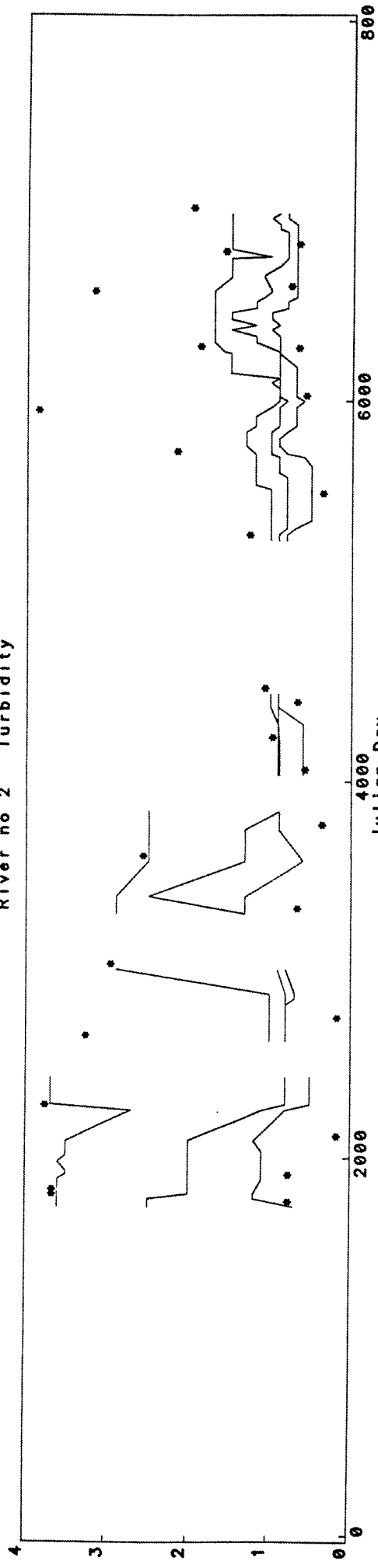
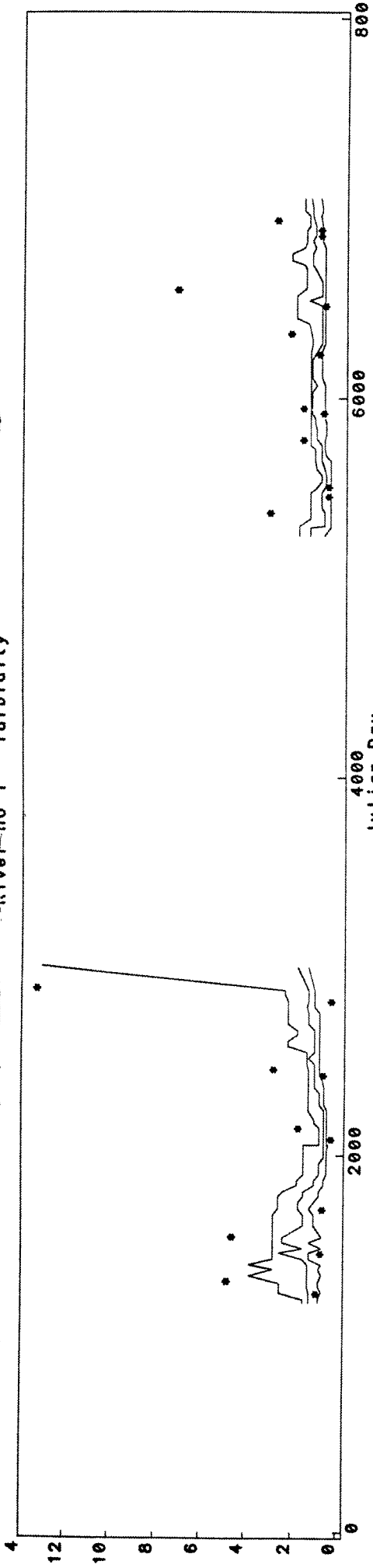

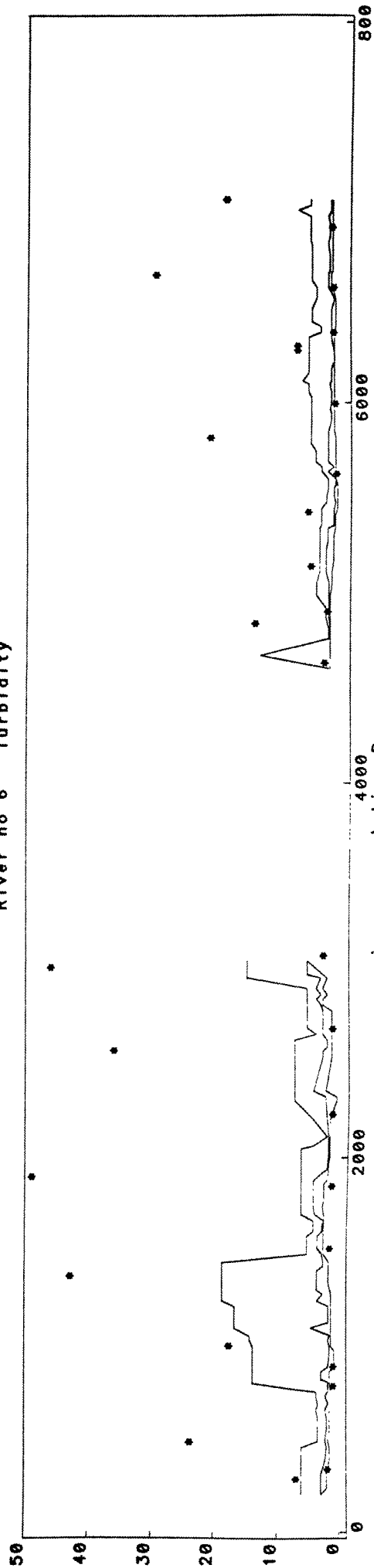
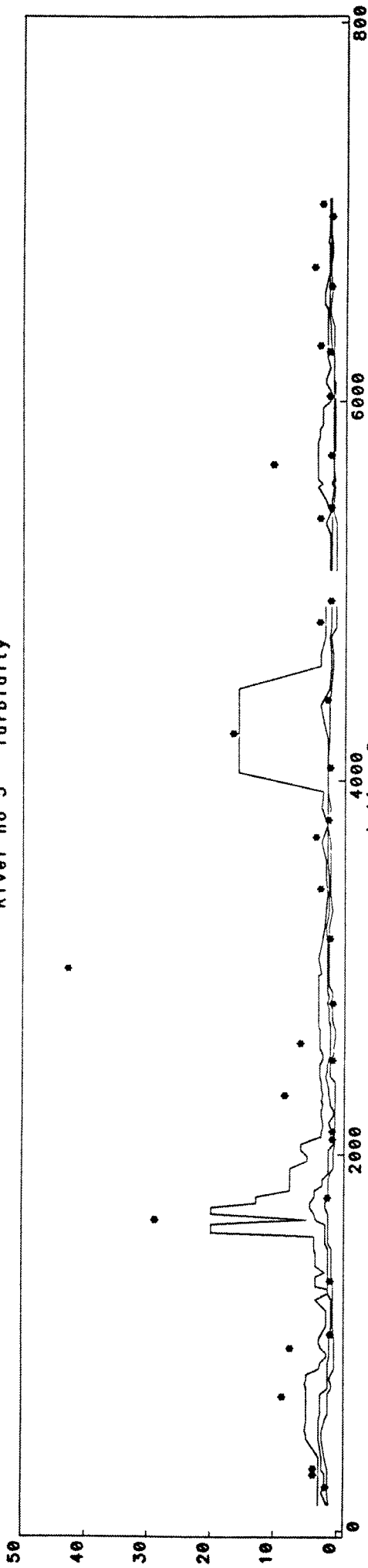
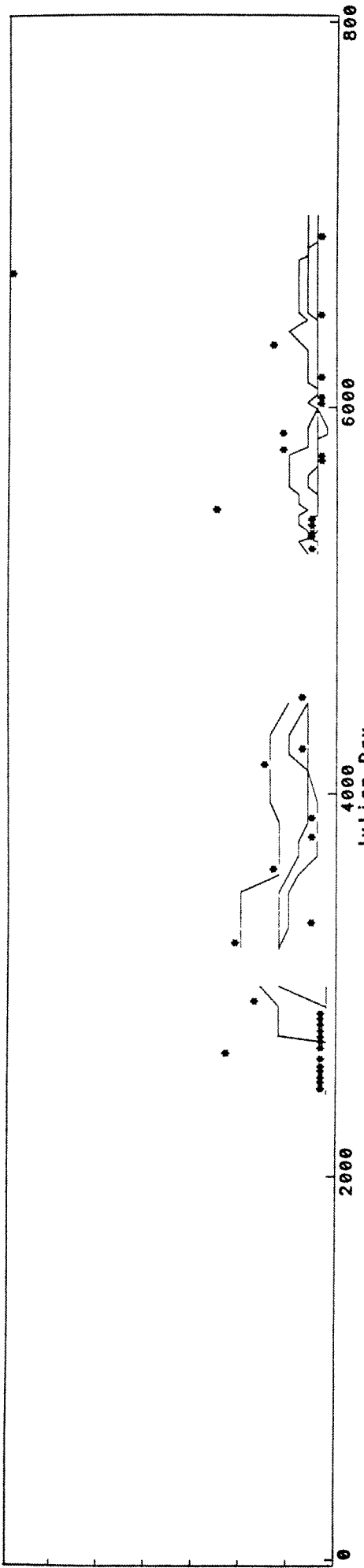

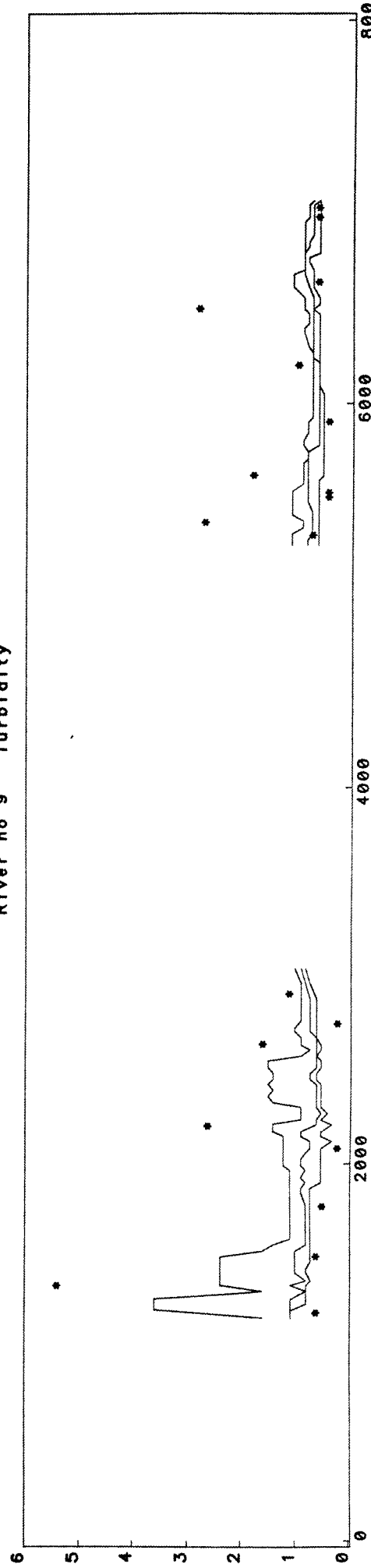
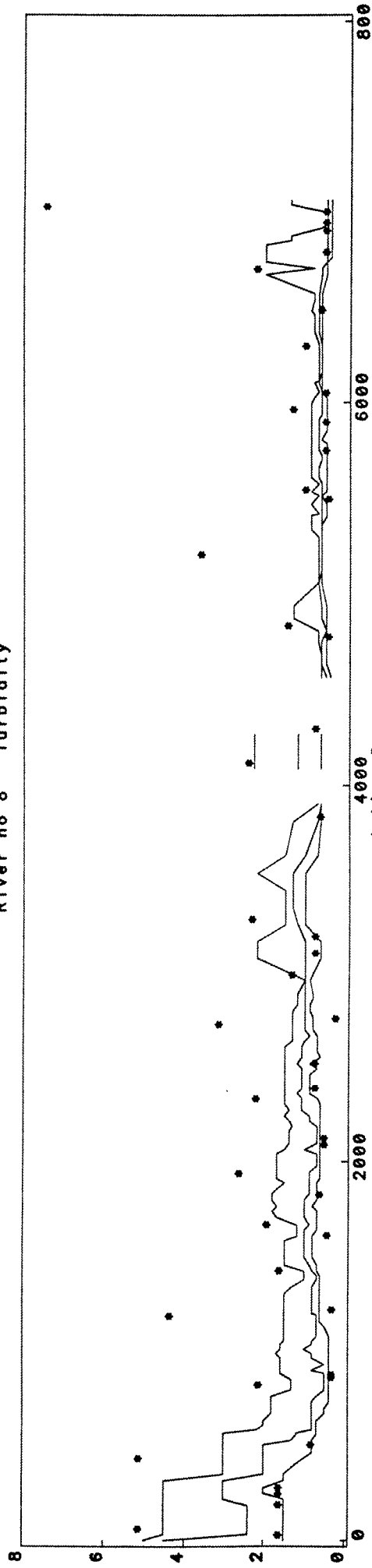
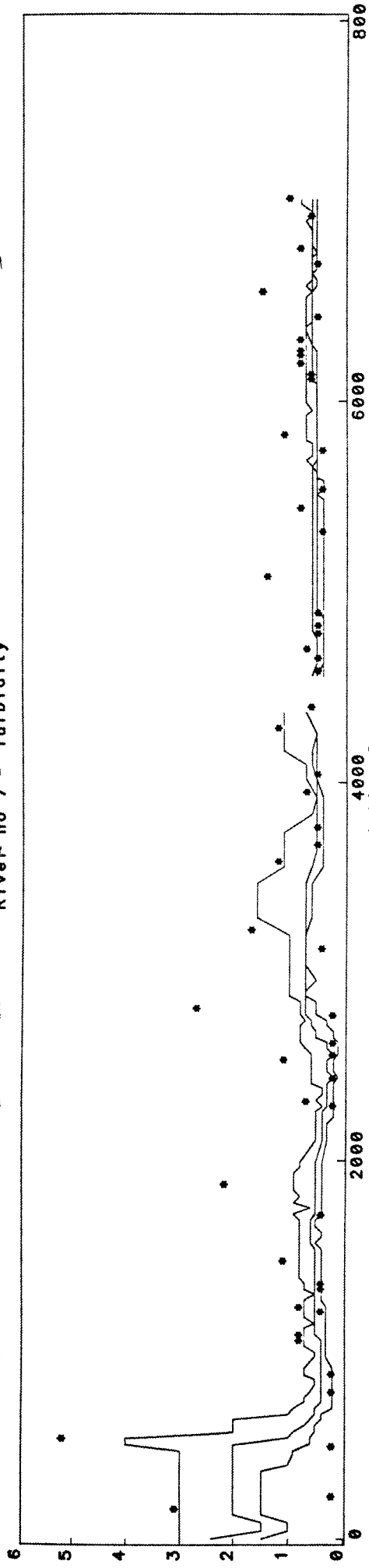

River no 10 Turbidity

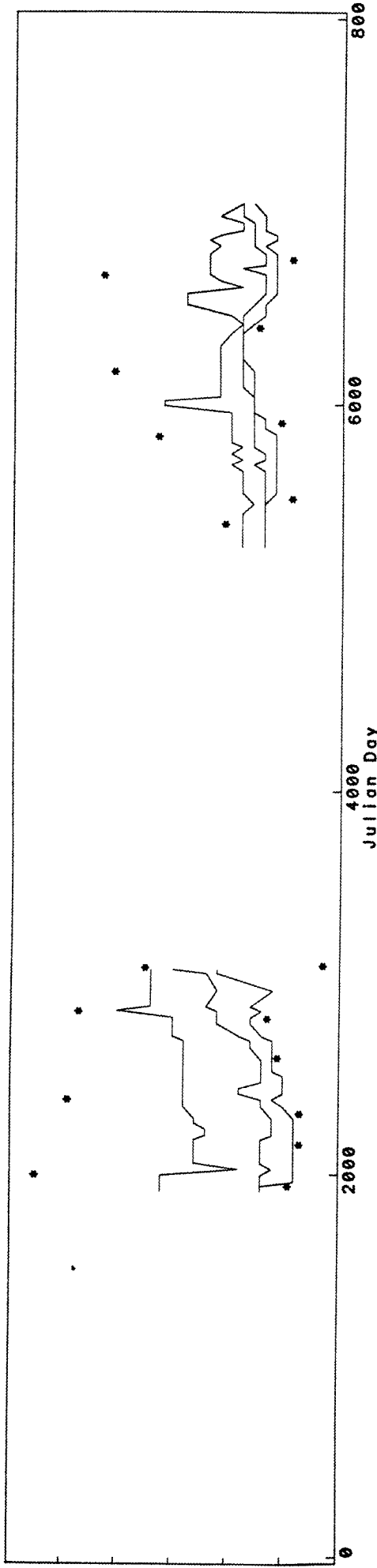

River no 11 Turbidity

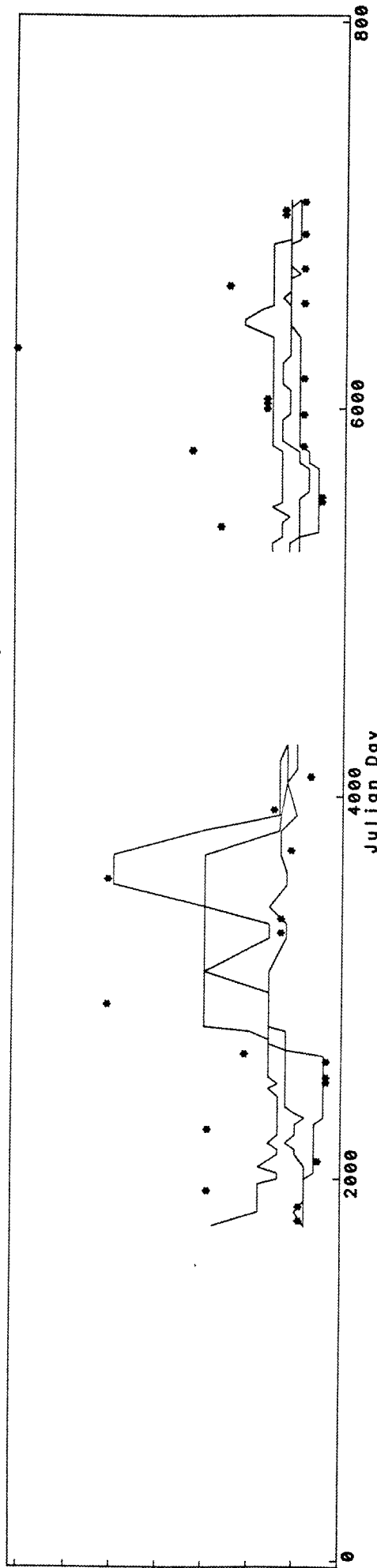

River no 12 Turbidity

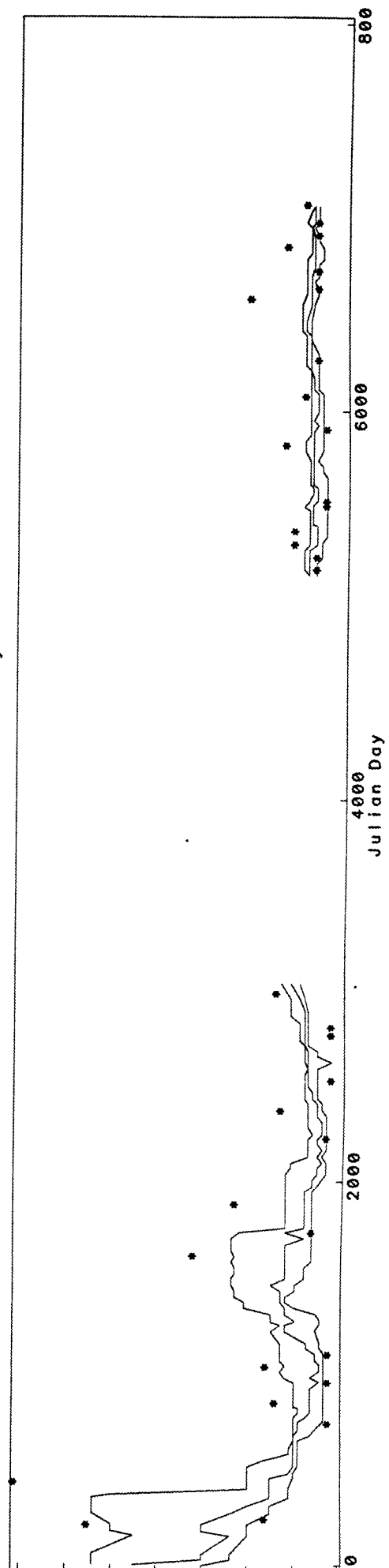



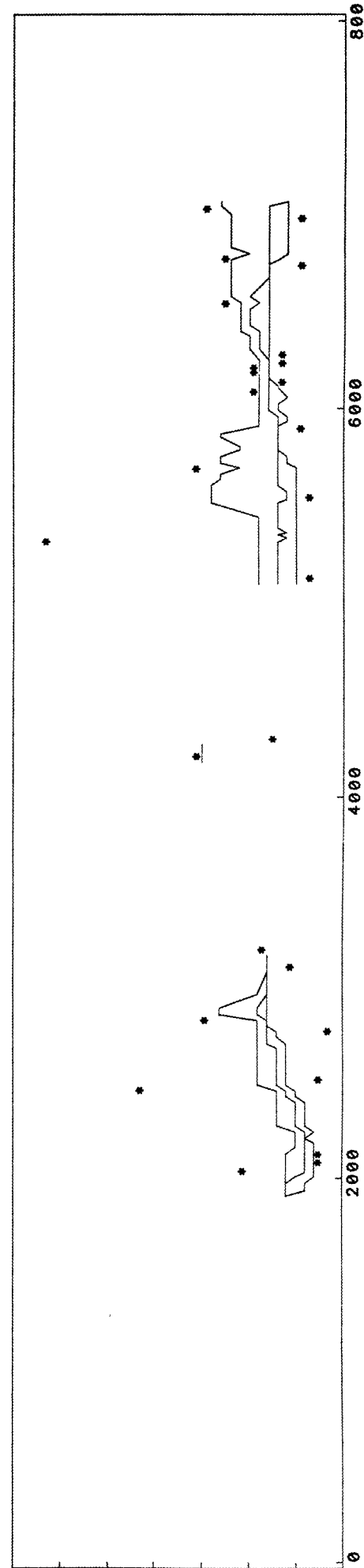
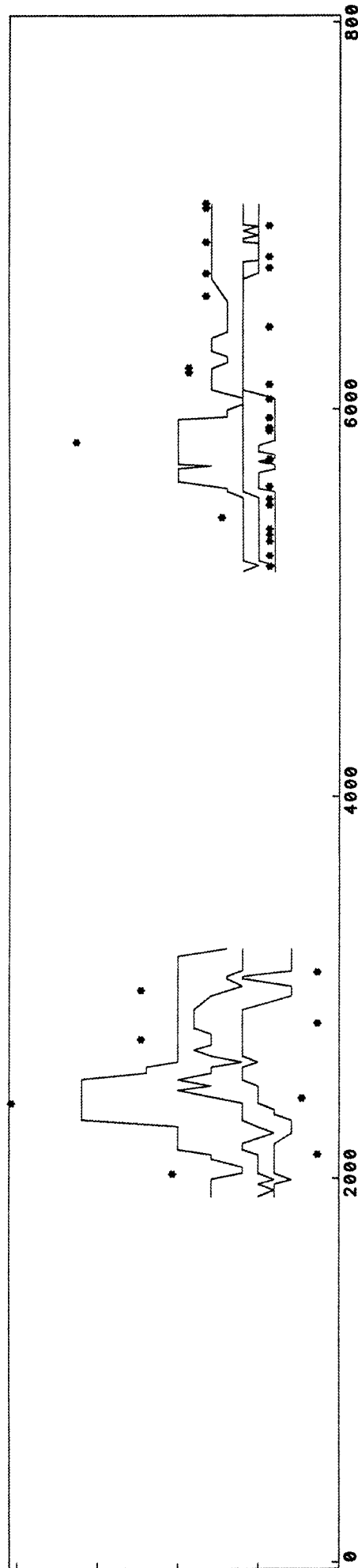
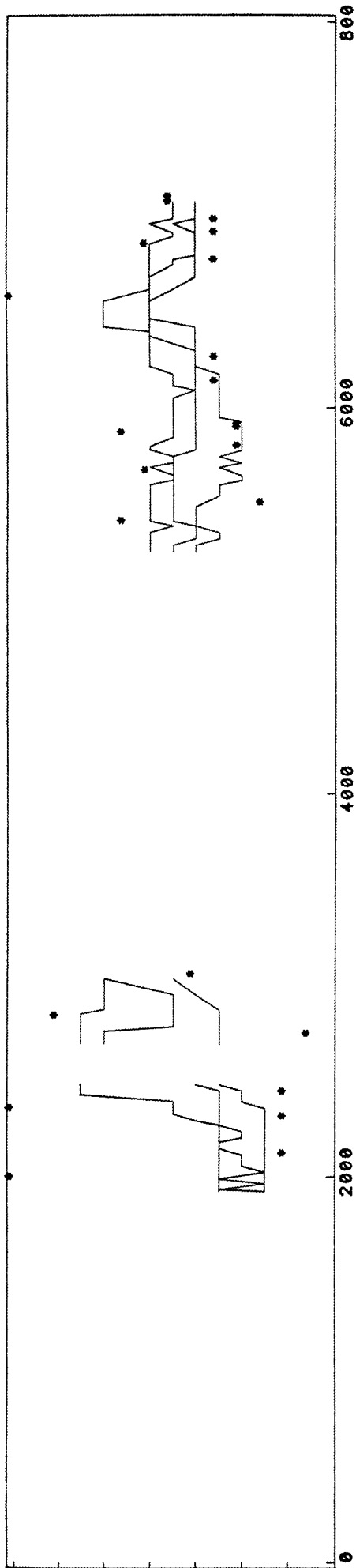

River no 18 Turbidity

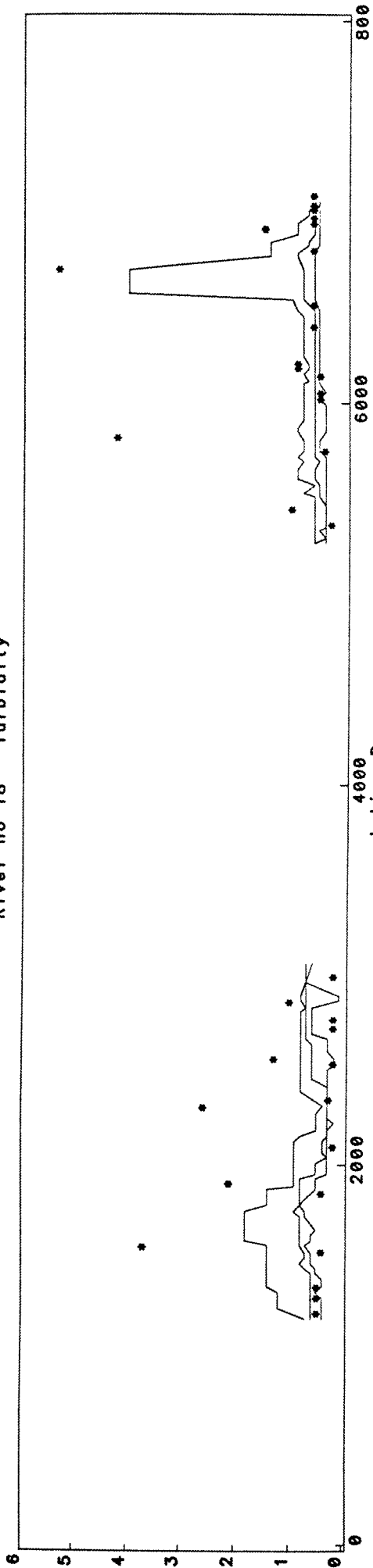

River no 19 Turbidity

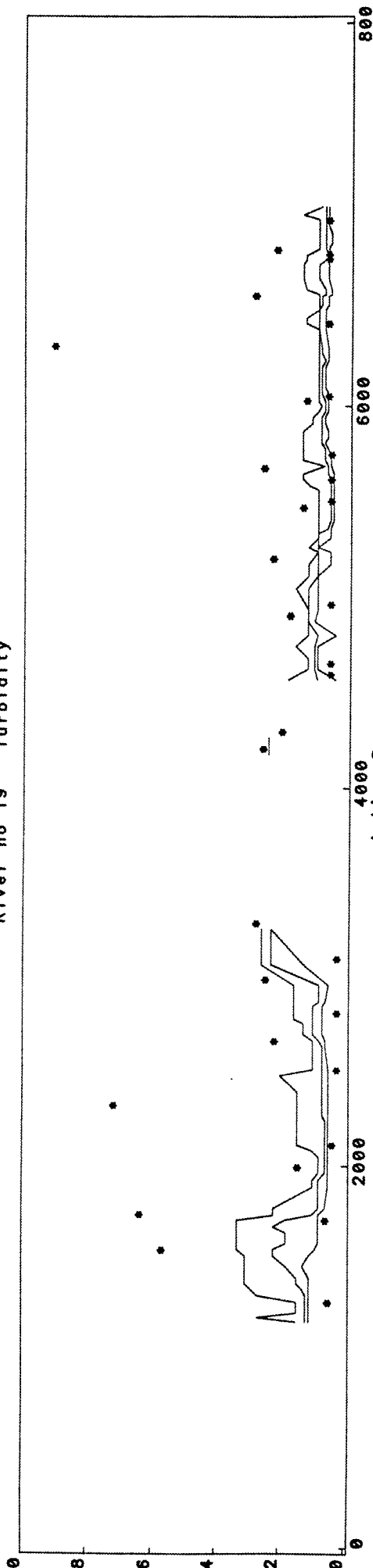

River no 20 Turbidity

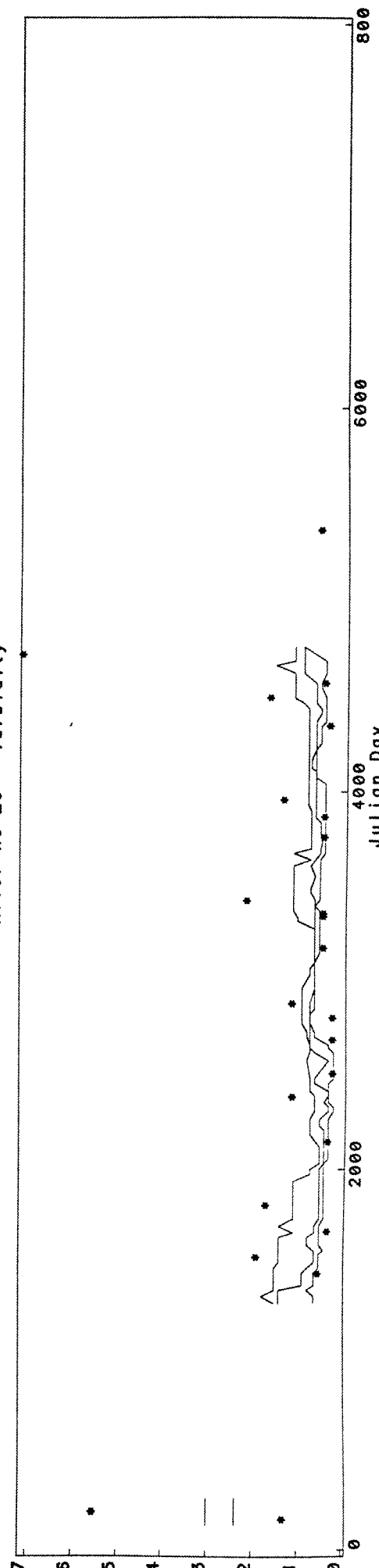

River no 21 Turbidity

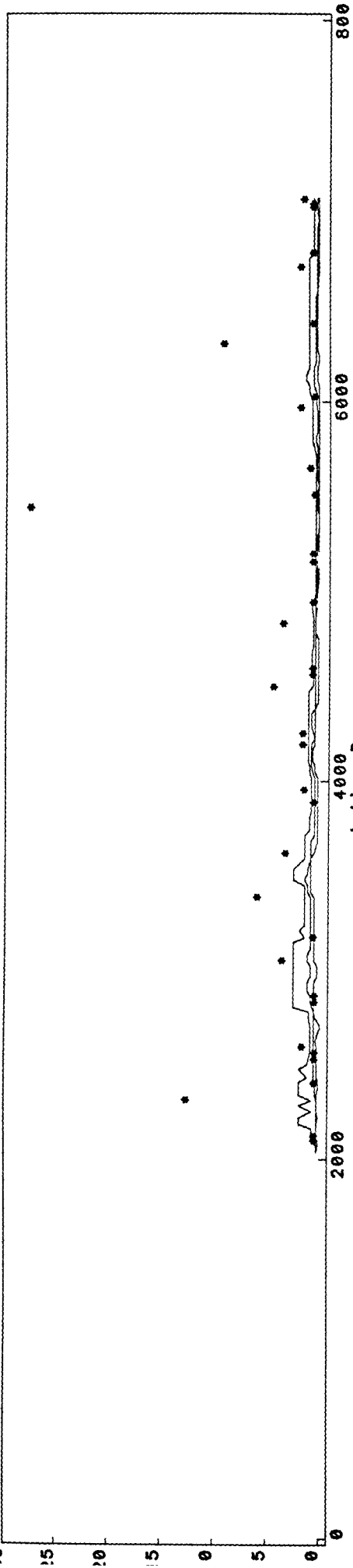

River no 22 Turbidity

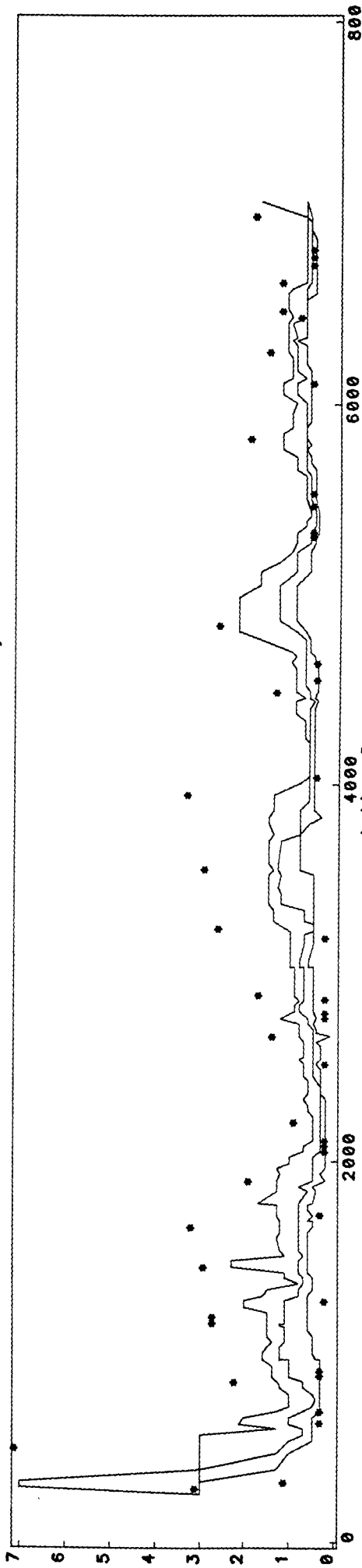

River no 23 Turbidity

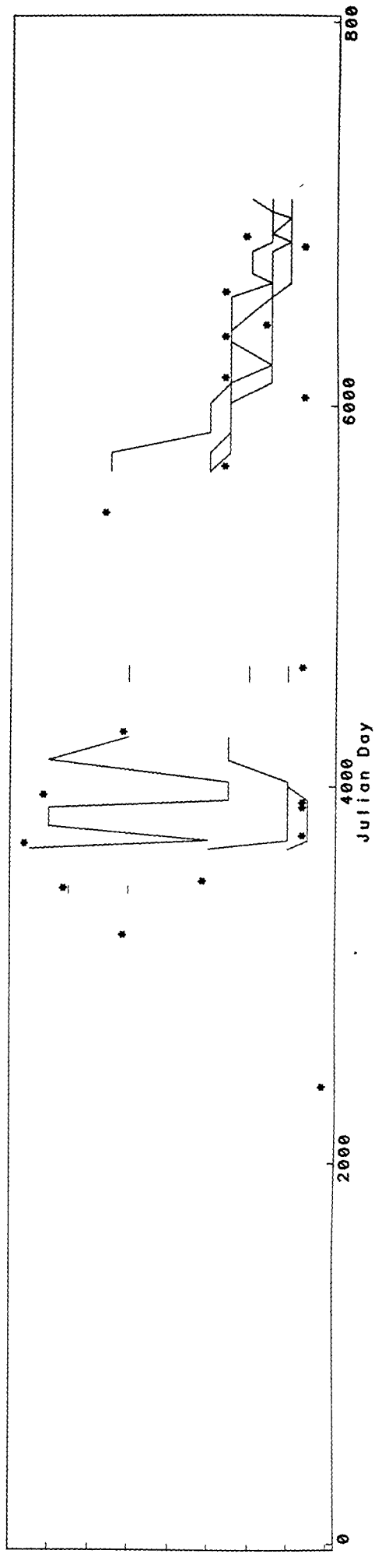

River no 25 Turbidity

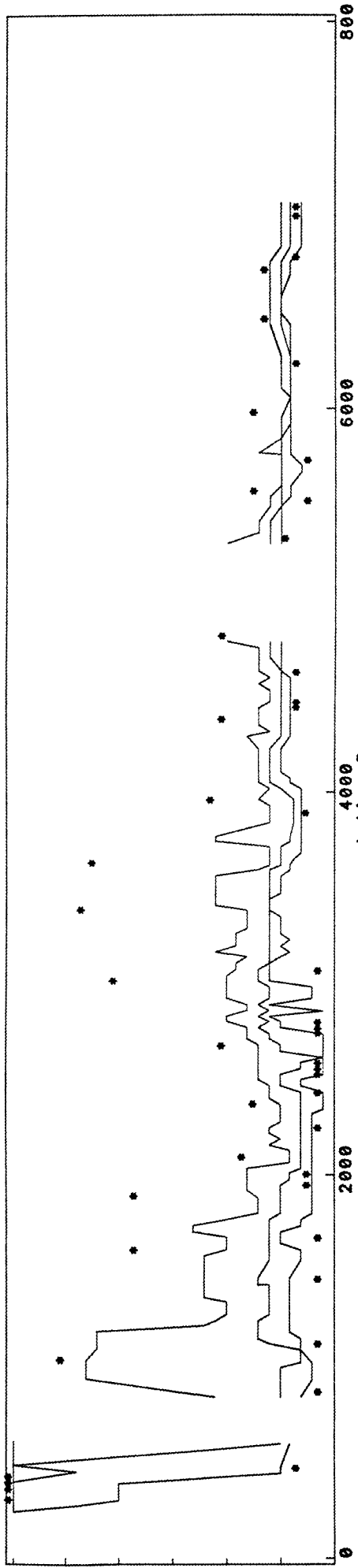

River no 26 Turbidity

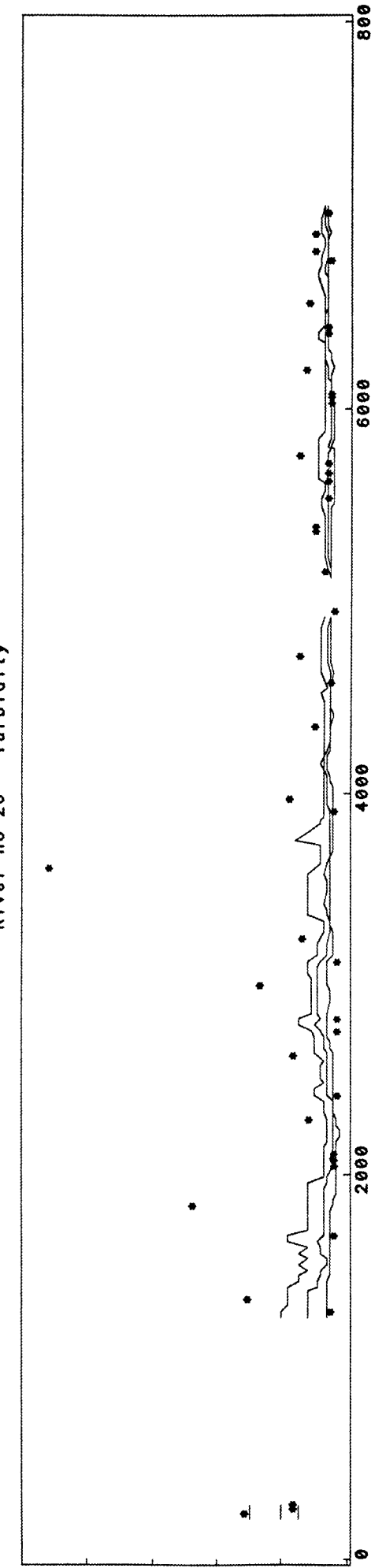

River no 27 Turbidity

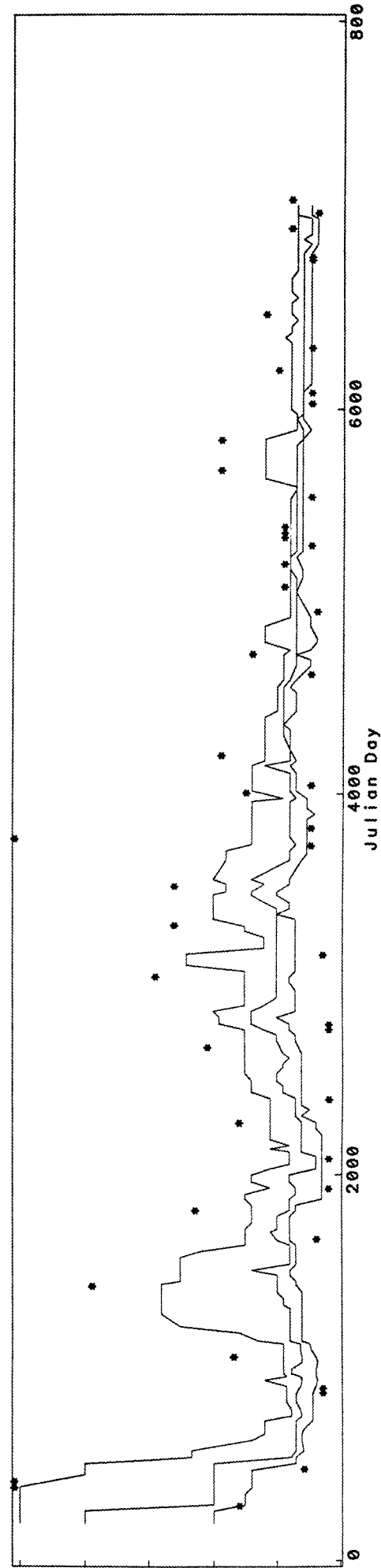

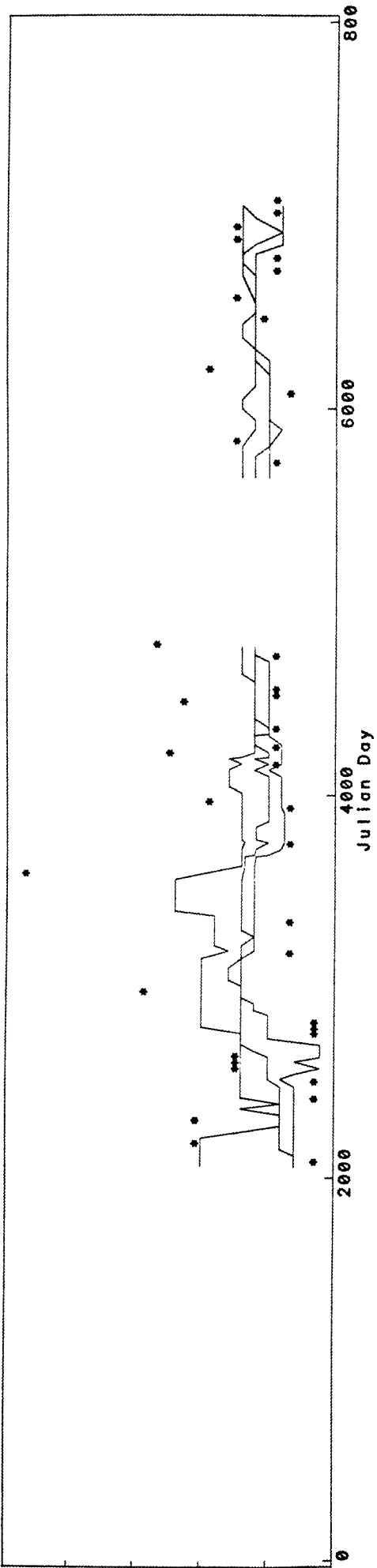

Appendix 18. Running boxplots of sodium for the study rivers.

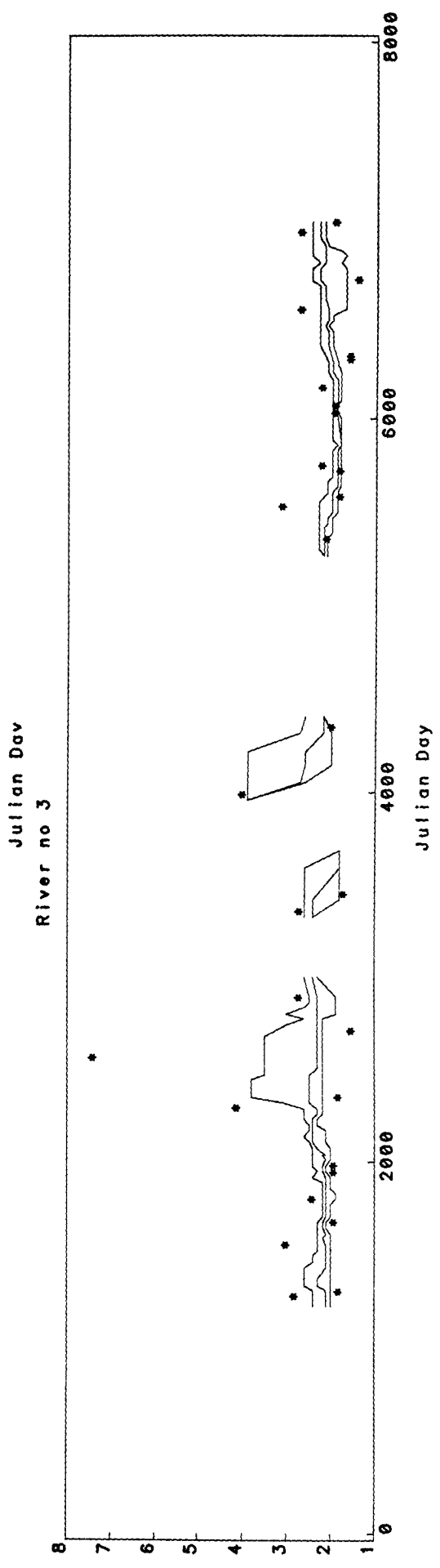
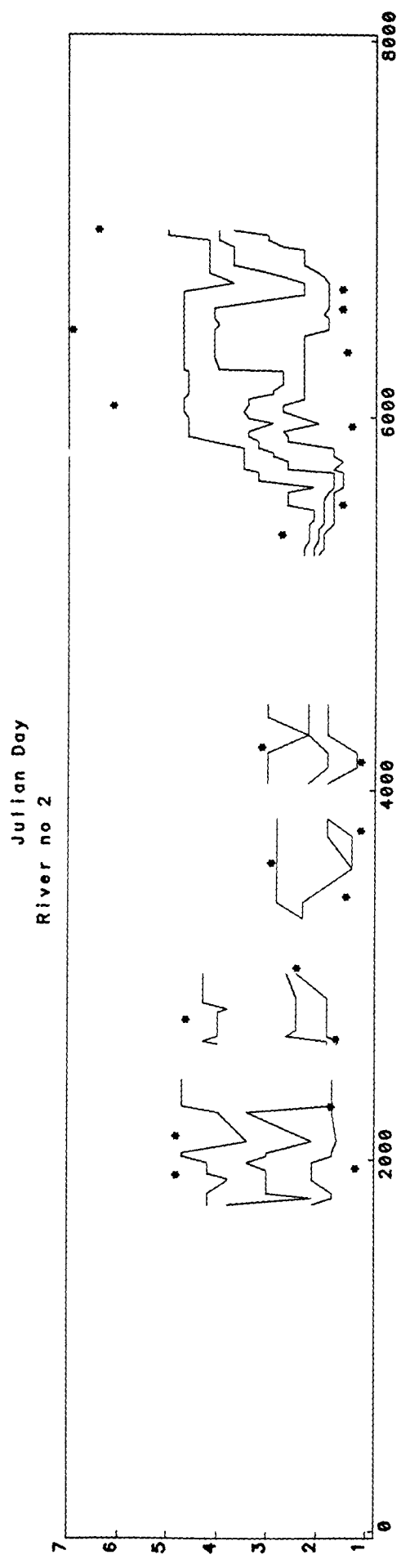
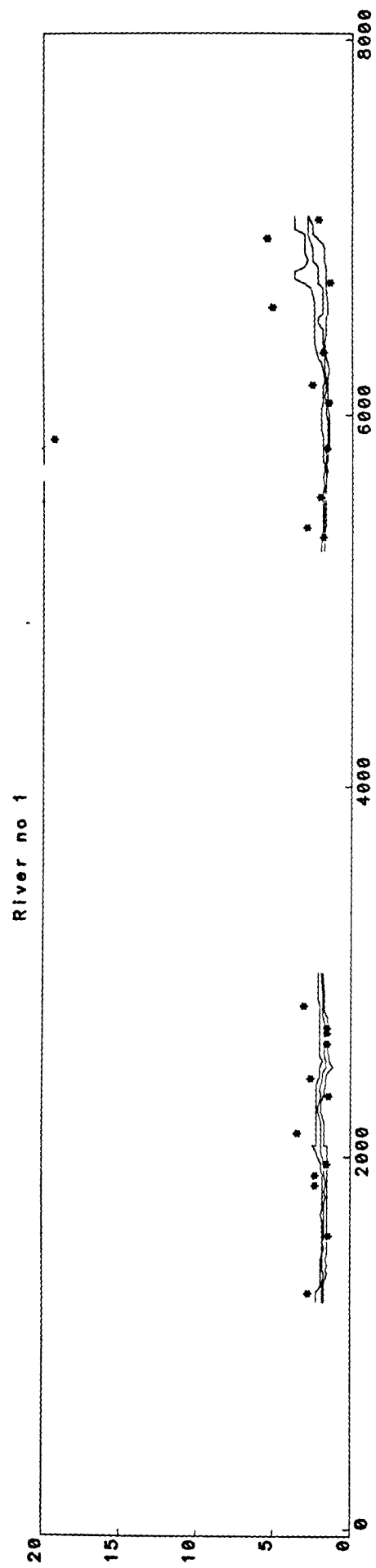

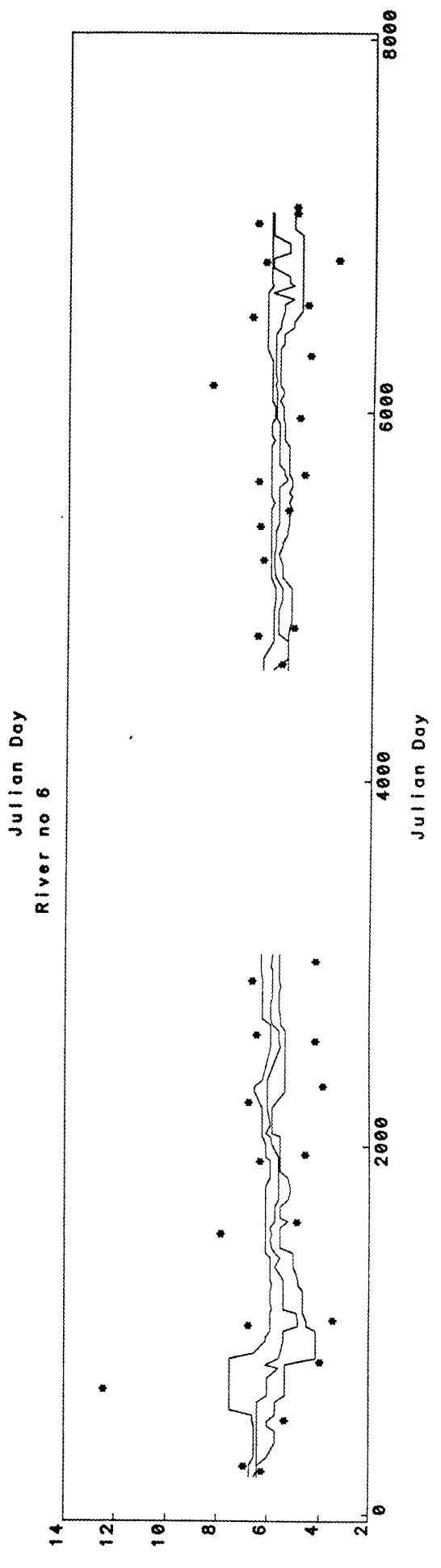
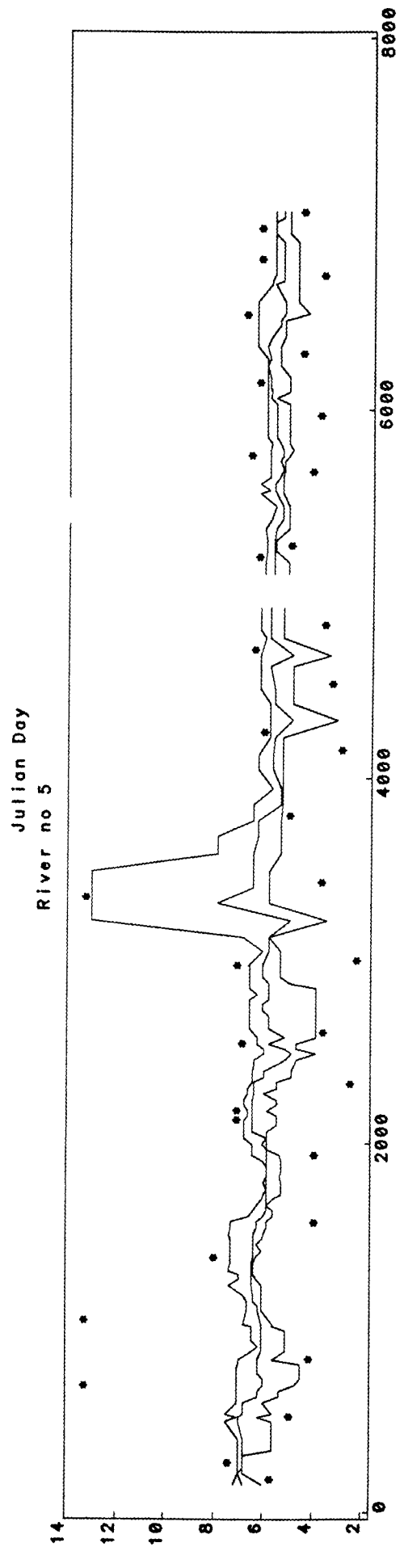
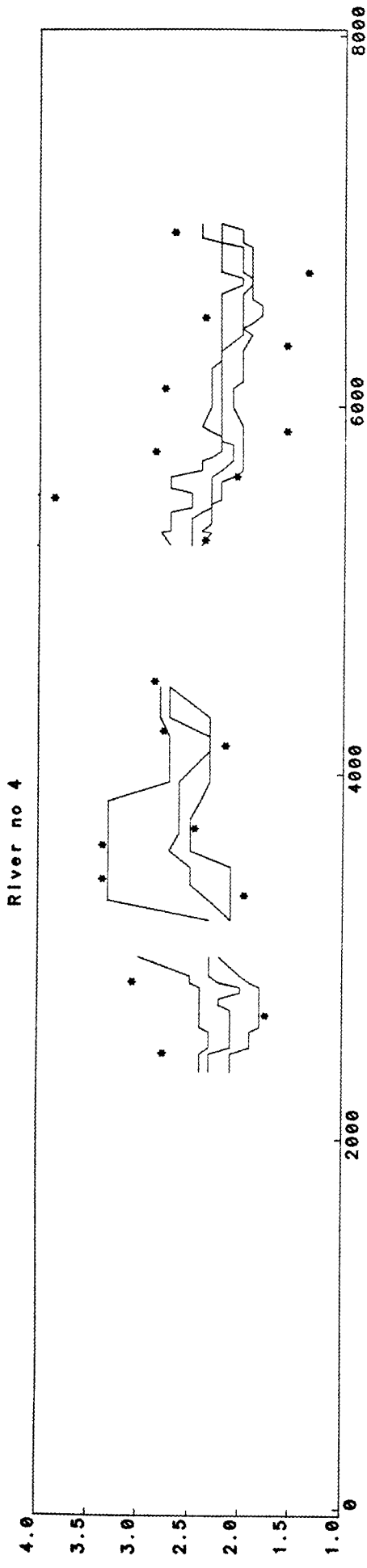



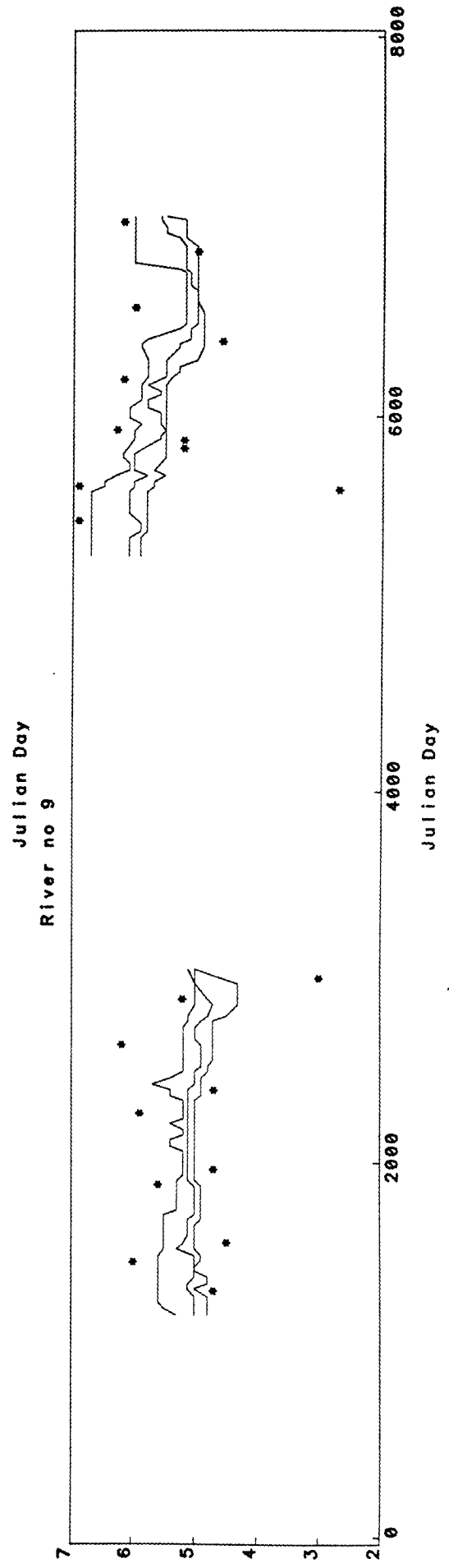
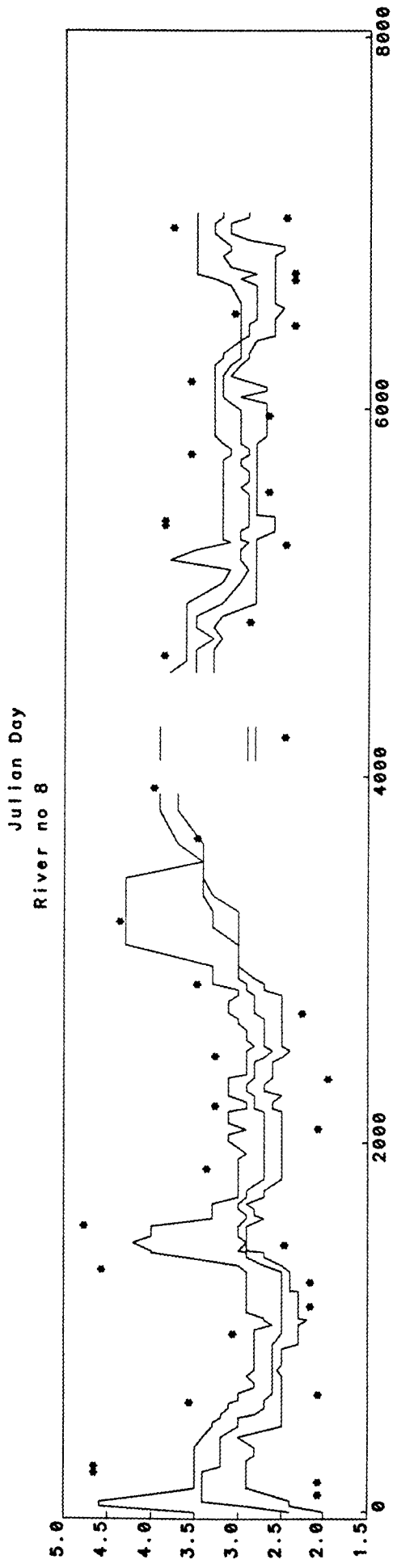
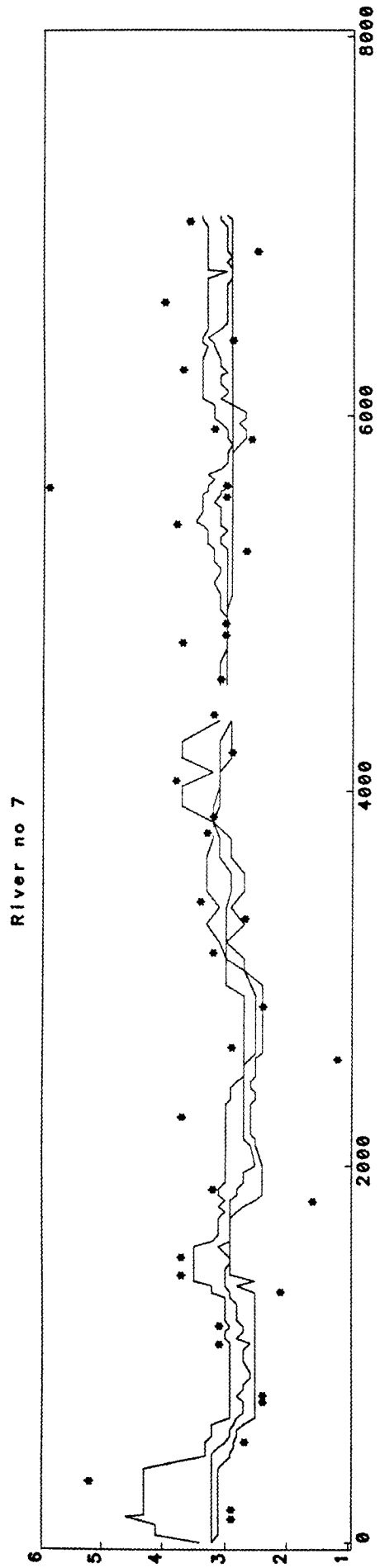

River no 10

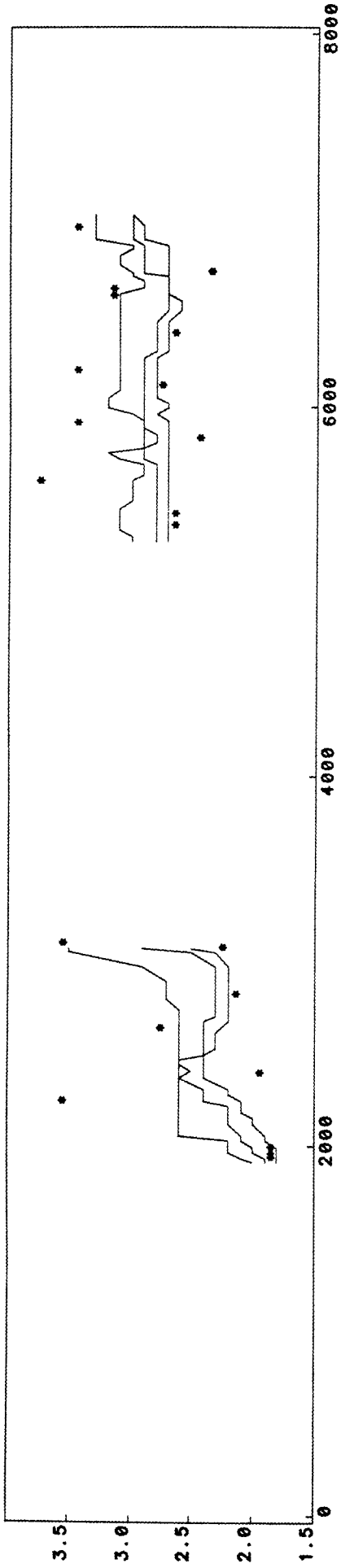

Julian Day

River no 11

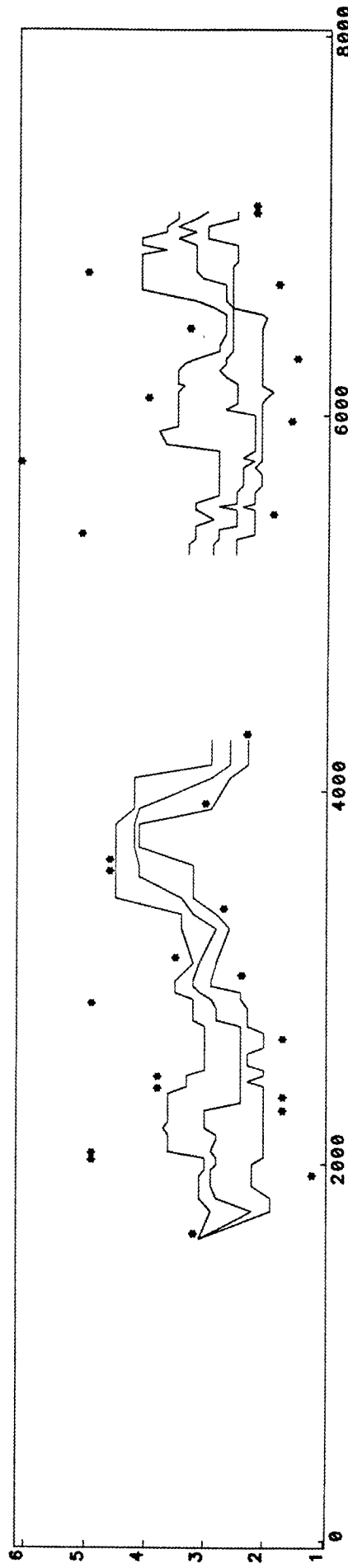

Julian Day

River no 12

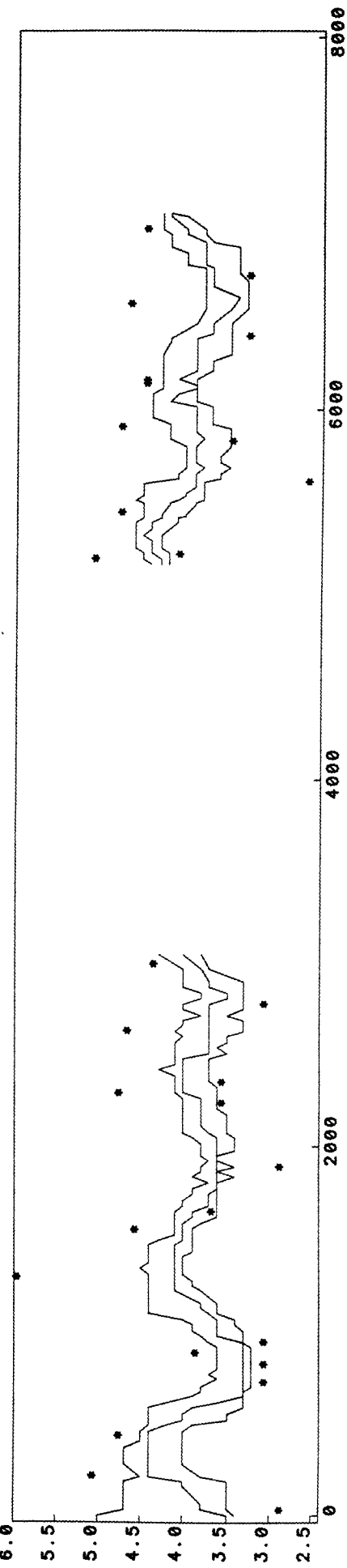

Julian Day

River no 13

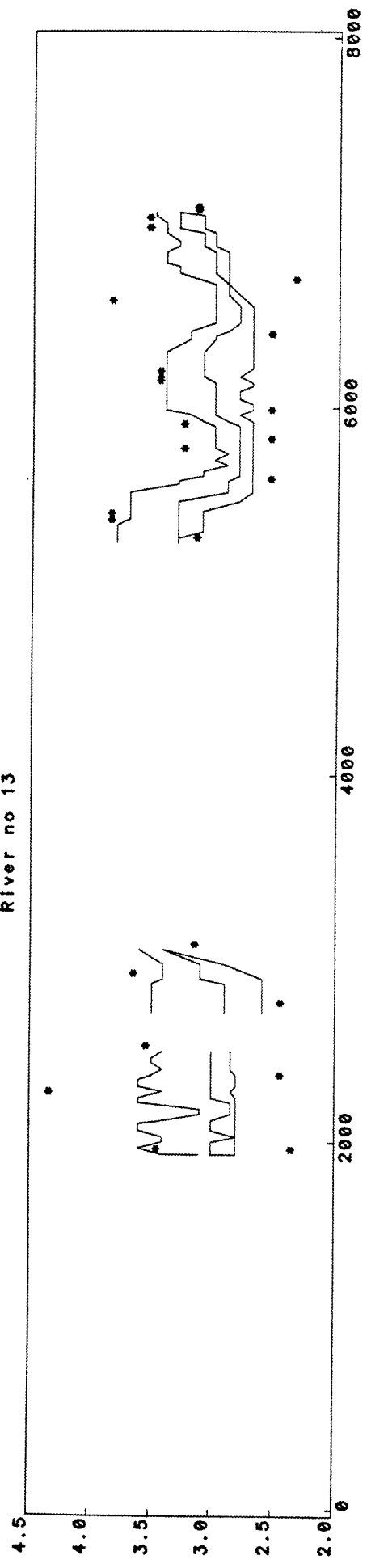

Julian Day  
River no 16

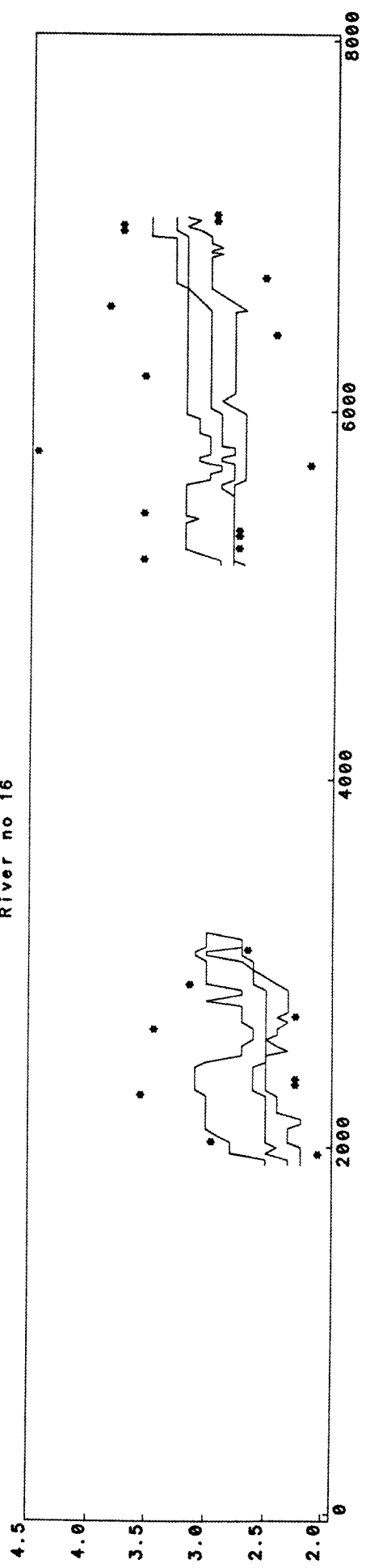

Julian Day  
River no 17

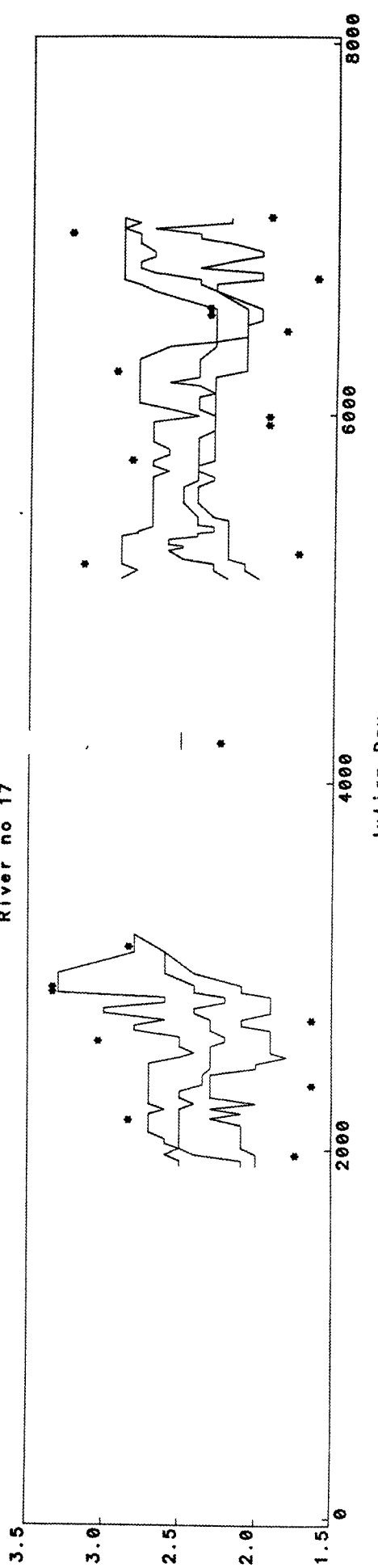

River no 18

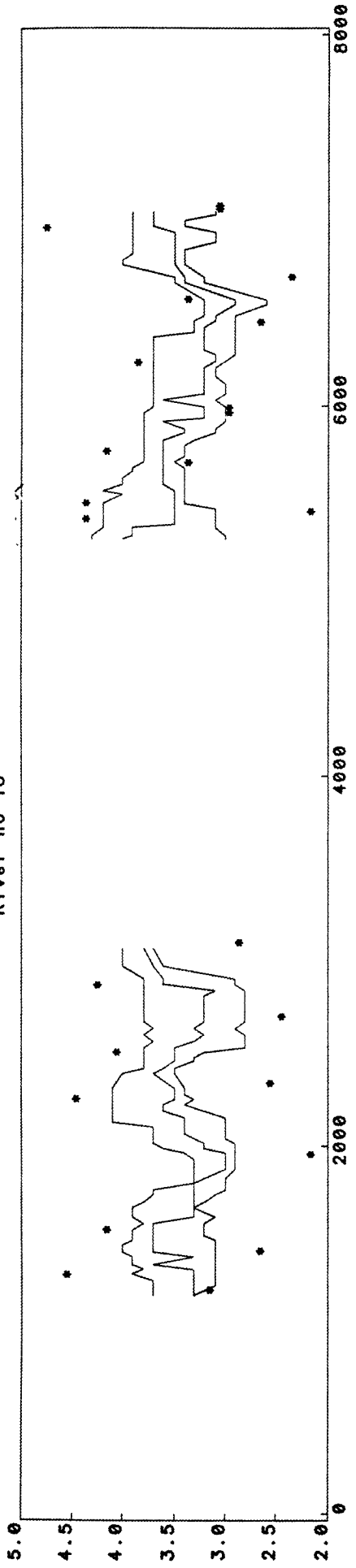

Julian Day  
River no 19

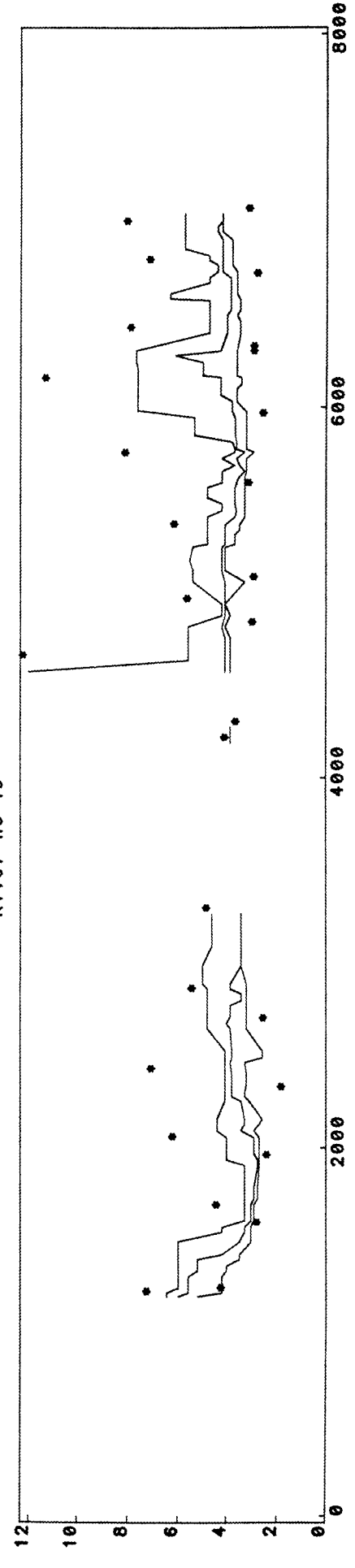

Julian Day  
River no 20

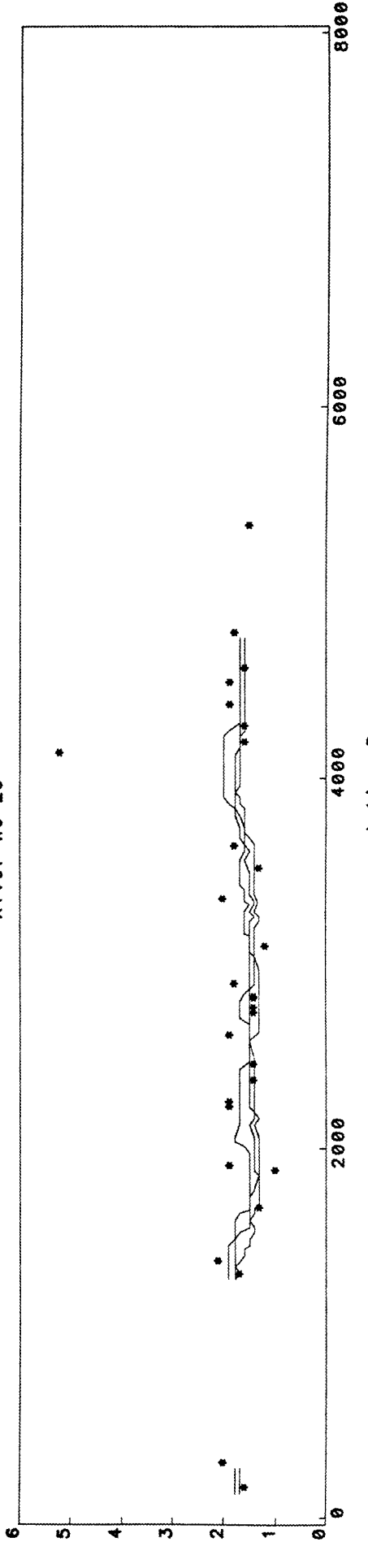

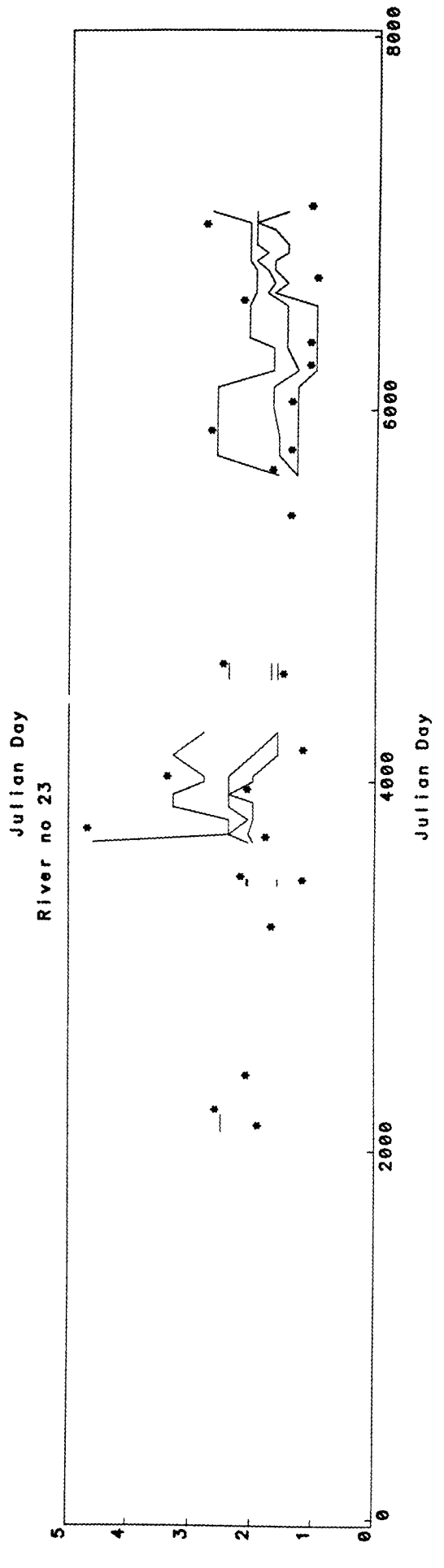
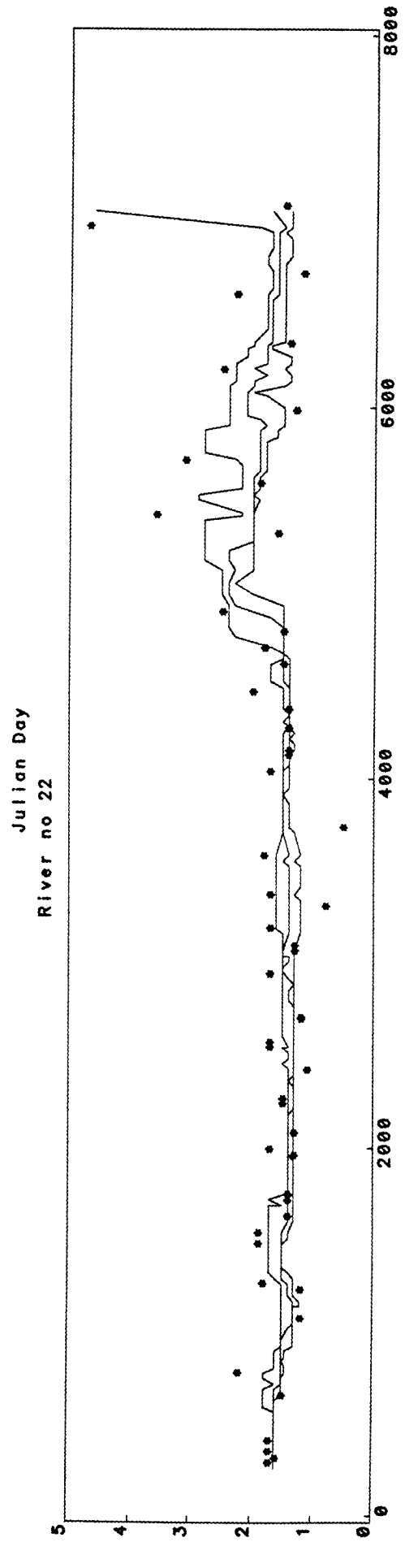
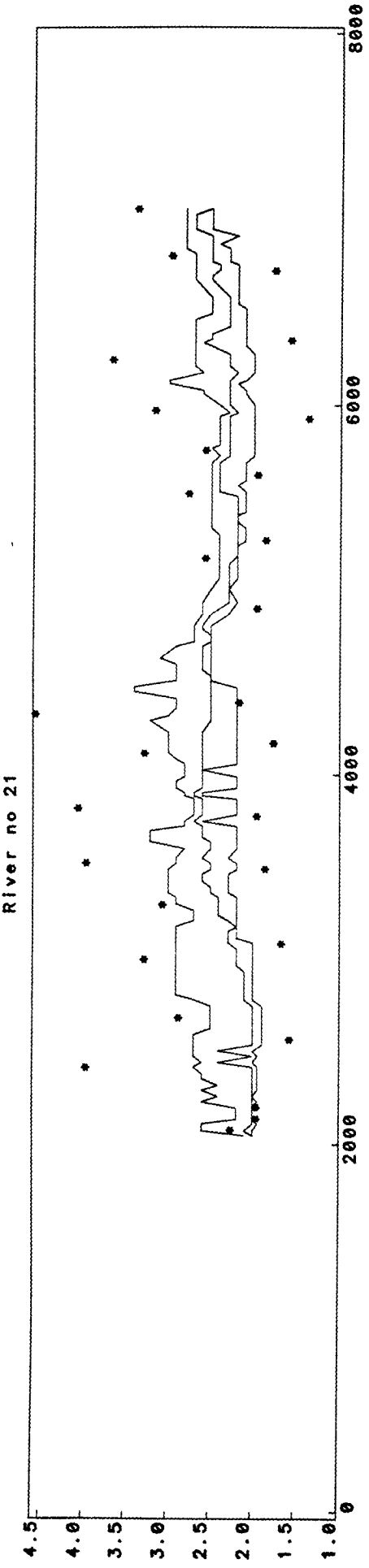

River no 25

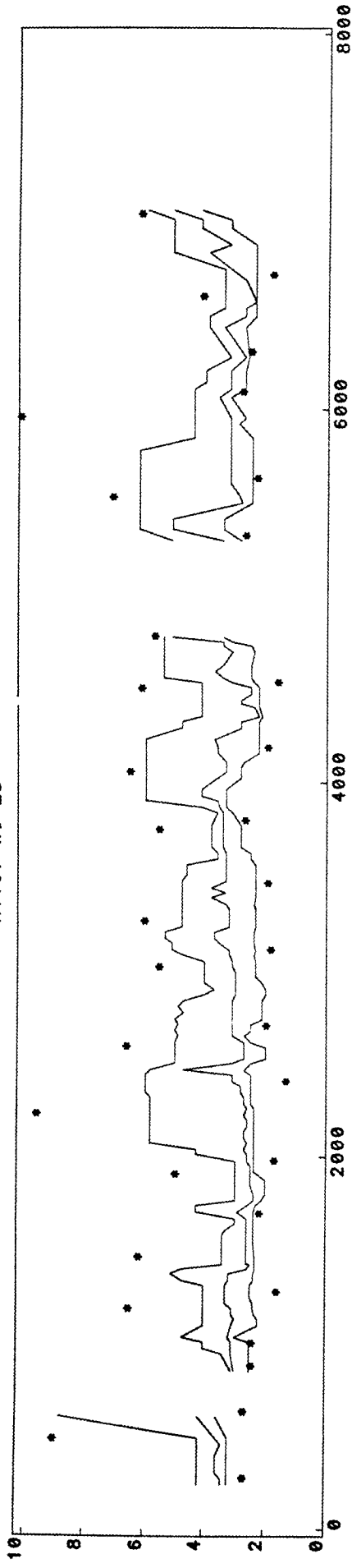

River no 26

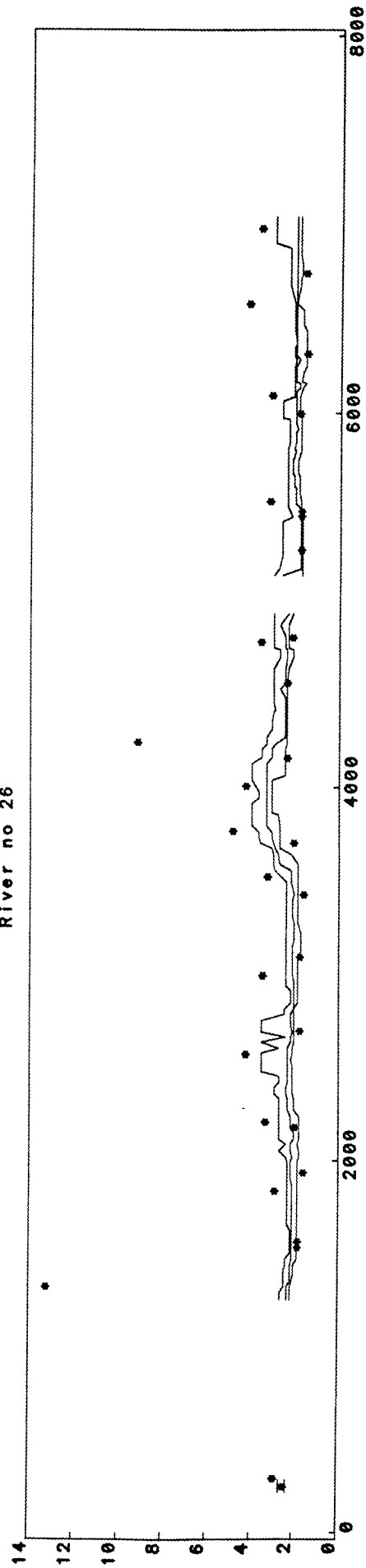

River no 27

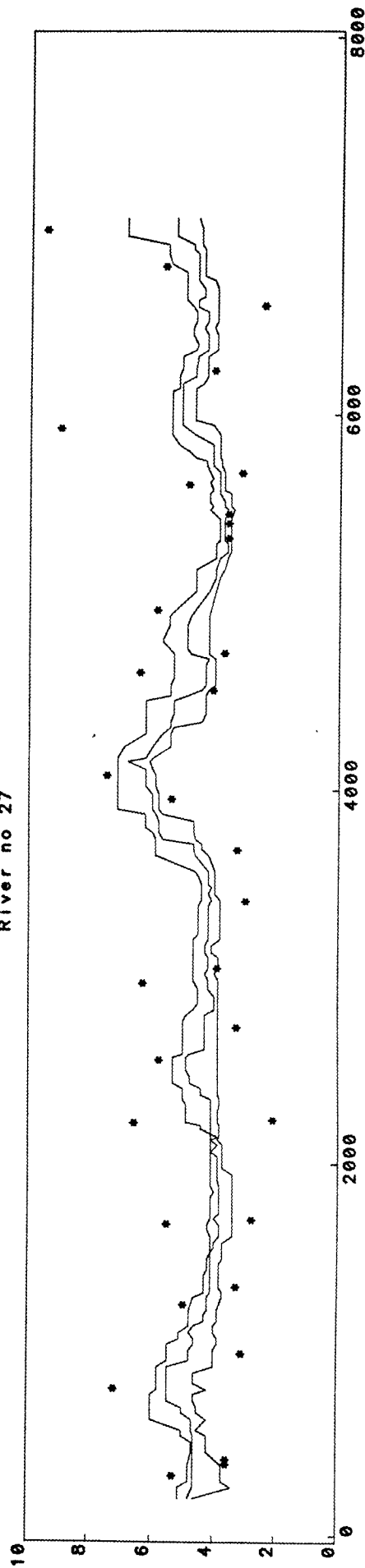

River no 28

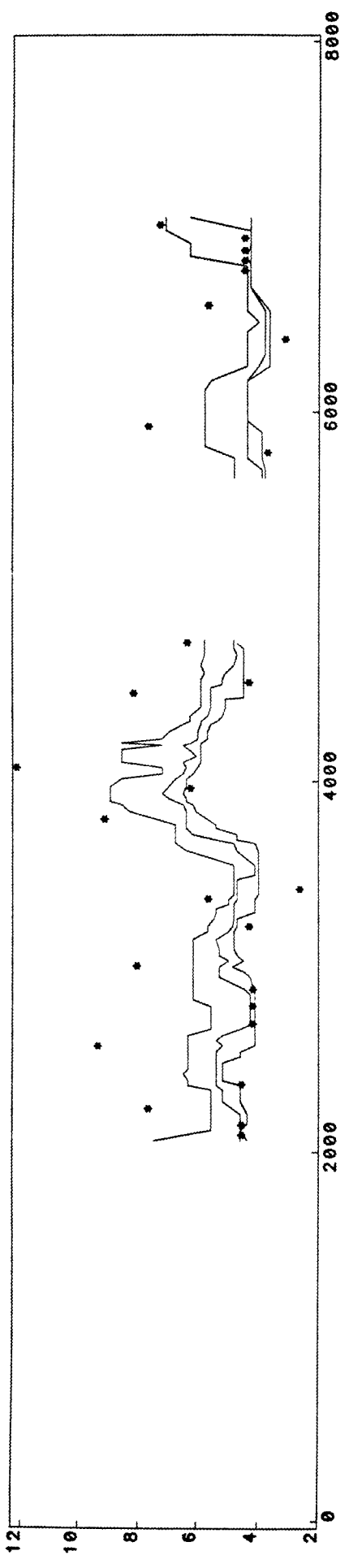

Julian Day

Appendix 19. Running boxplots of aluminum for the study rivers.



River no 1 Al (Aluminum)

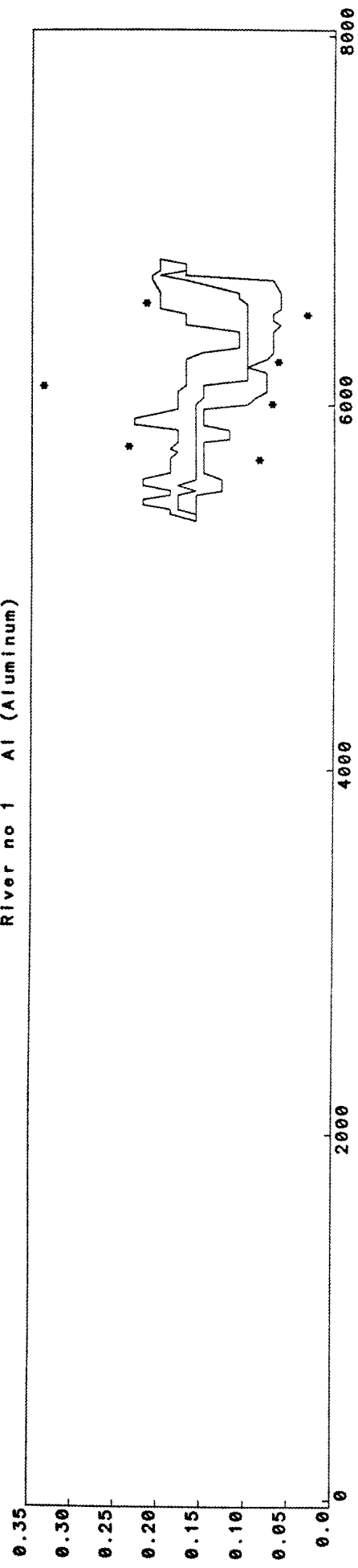

River no 2 Al (Aluminum)

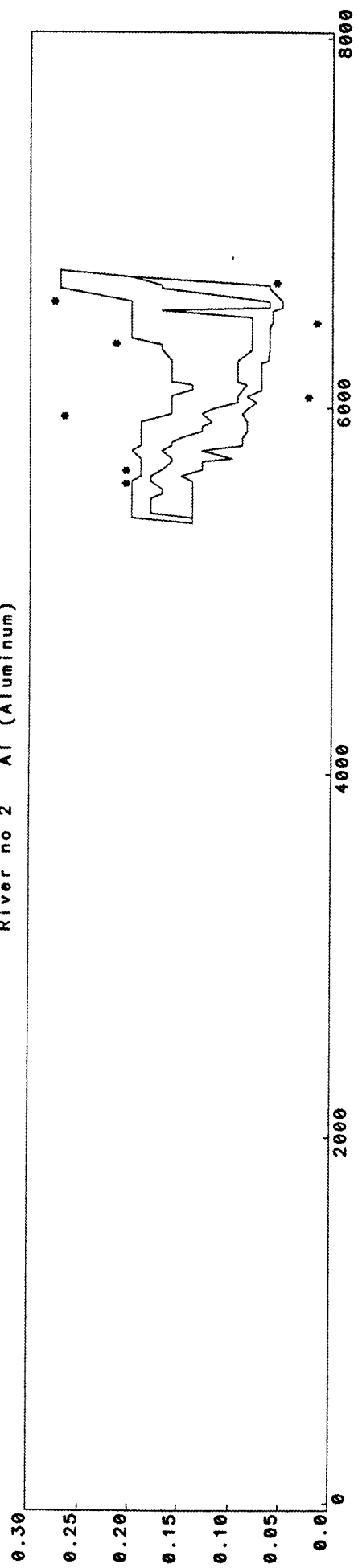

River no 3 Al (Aluminum)

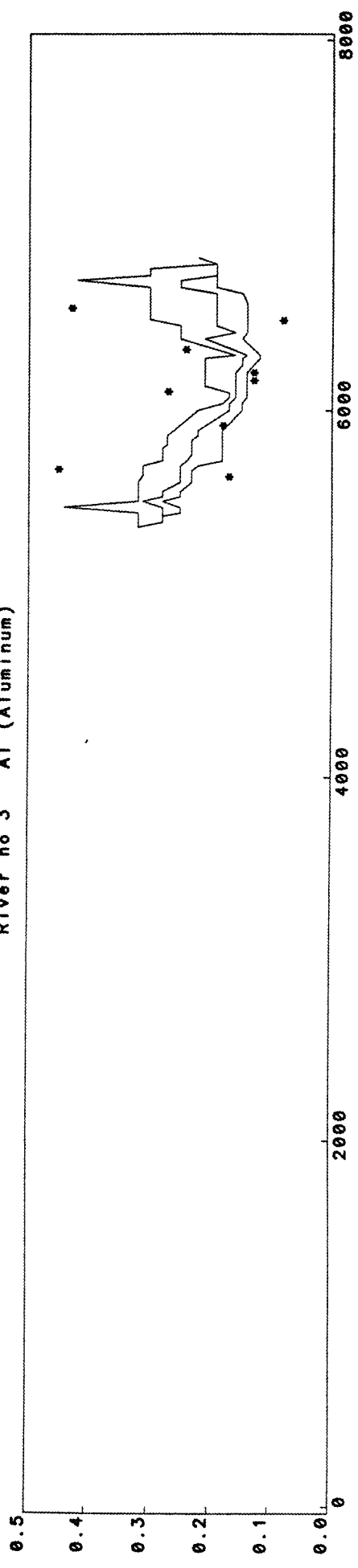

River no 4 Al (Aluminum)

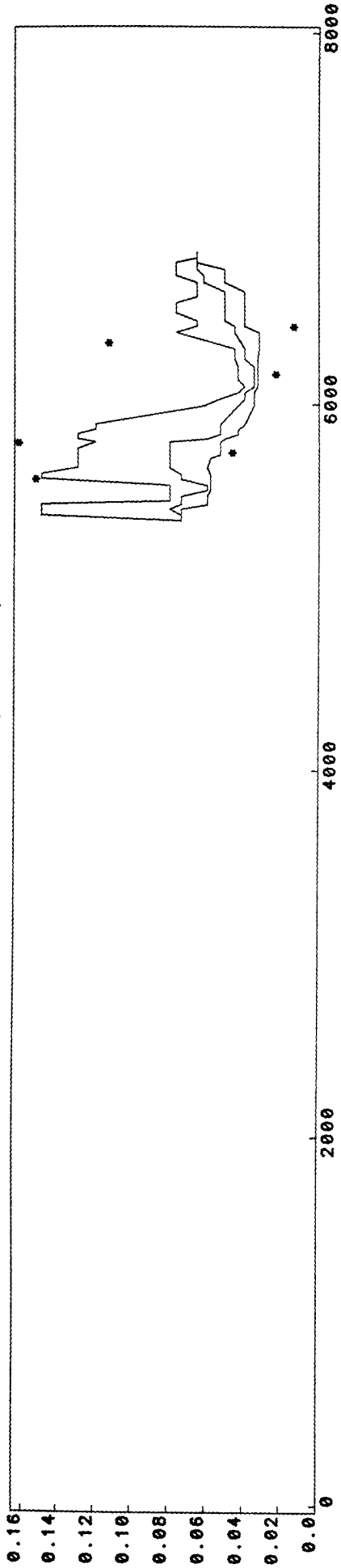

River no 5 Al (Aluminum)

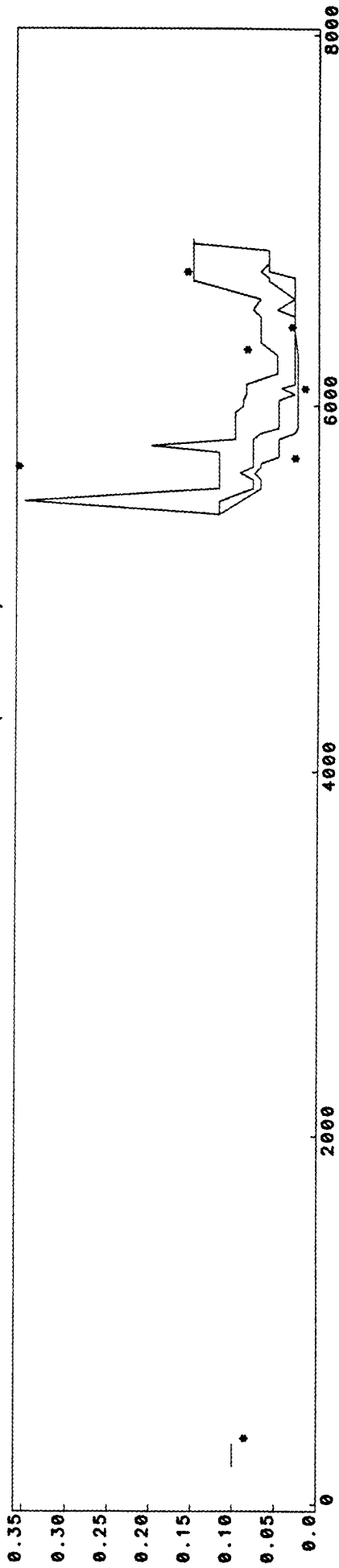

River no 6 Al (Aluminum)

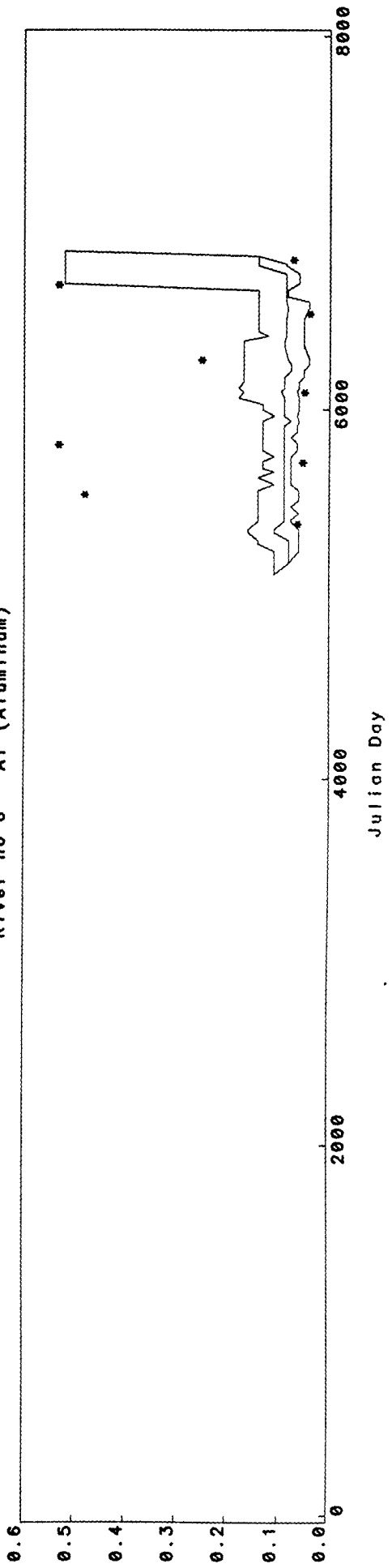

River no 7 Al (Aluminum)

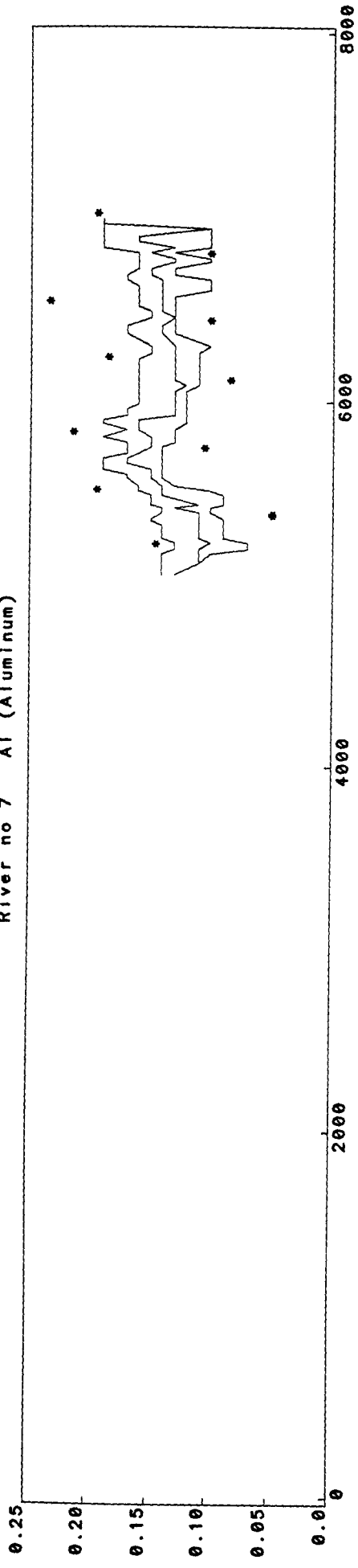

River no 8 Al (Aluminum)

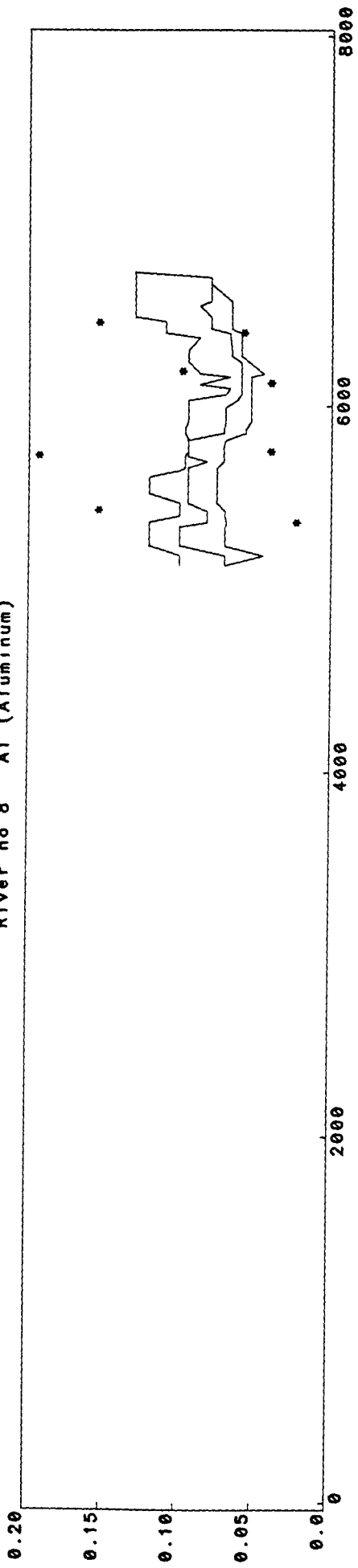

River no 9 Al (Aluminum)

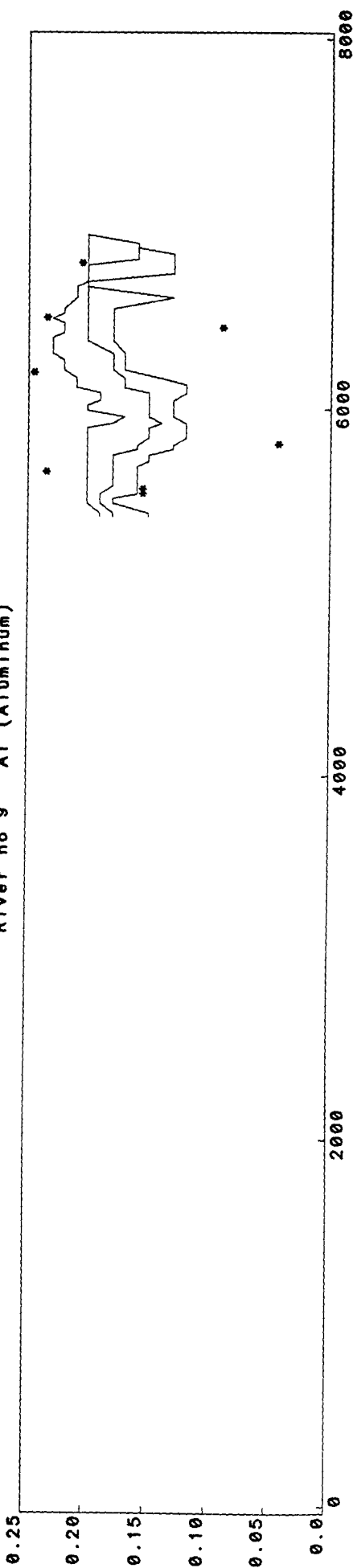

River no 10 Al (Aluminum)

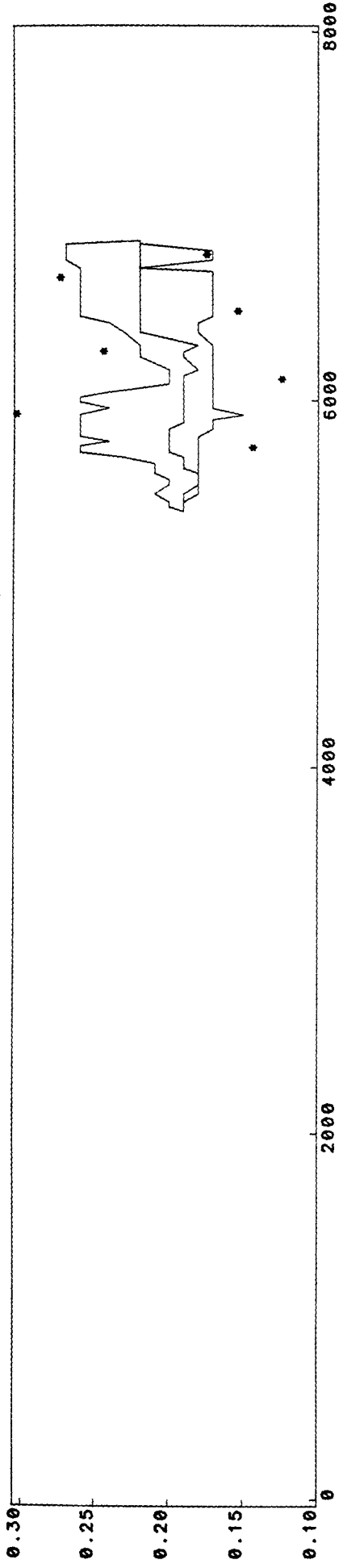

River no 11 Al (Aluminum)

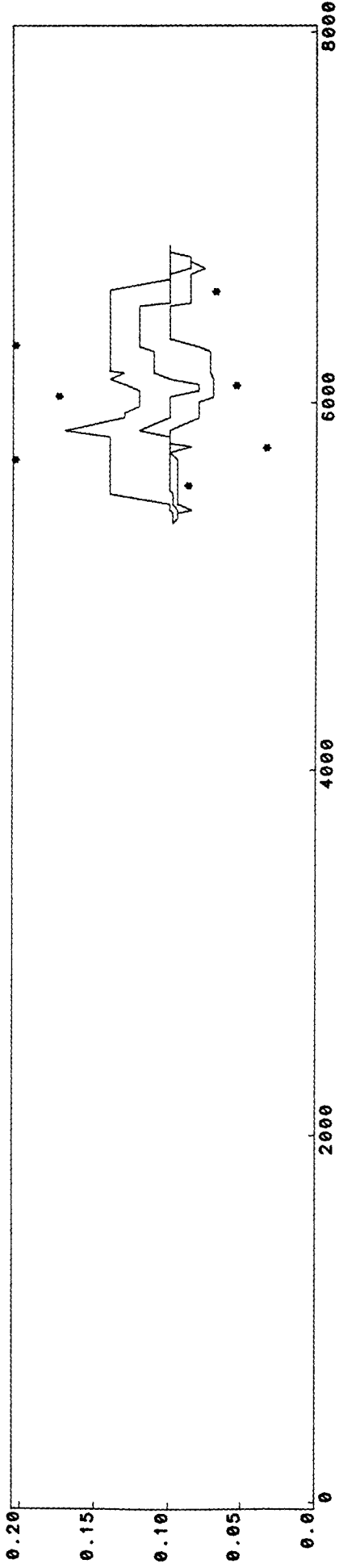

River no 12 Al (Aluminum)

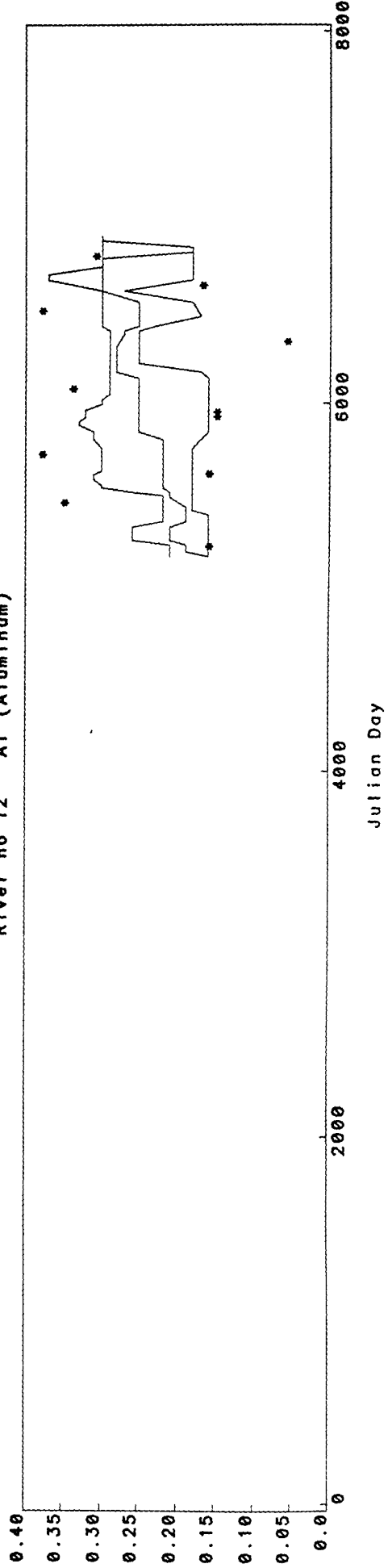

River no 13 Al (Aluminum)

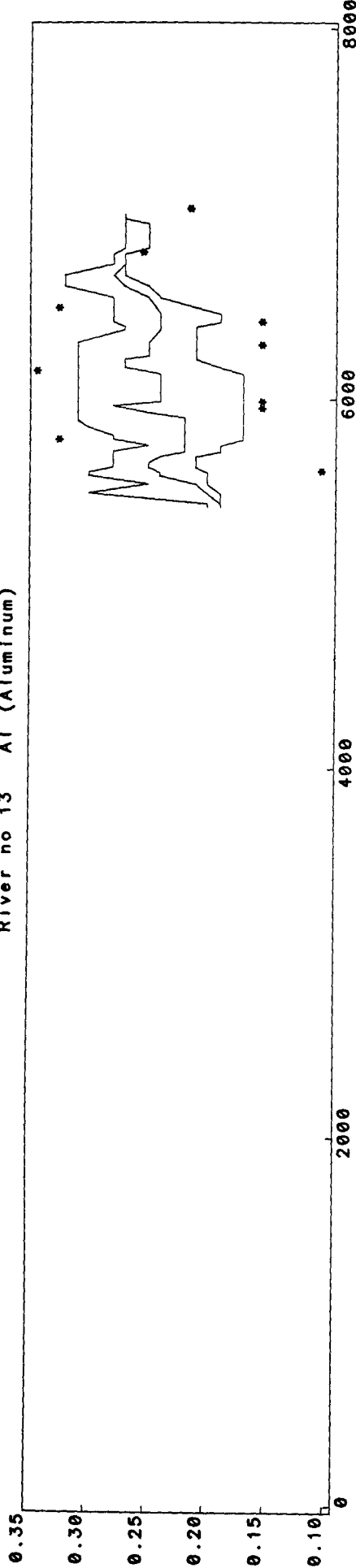

River no 16 Al (Aluminum)

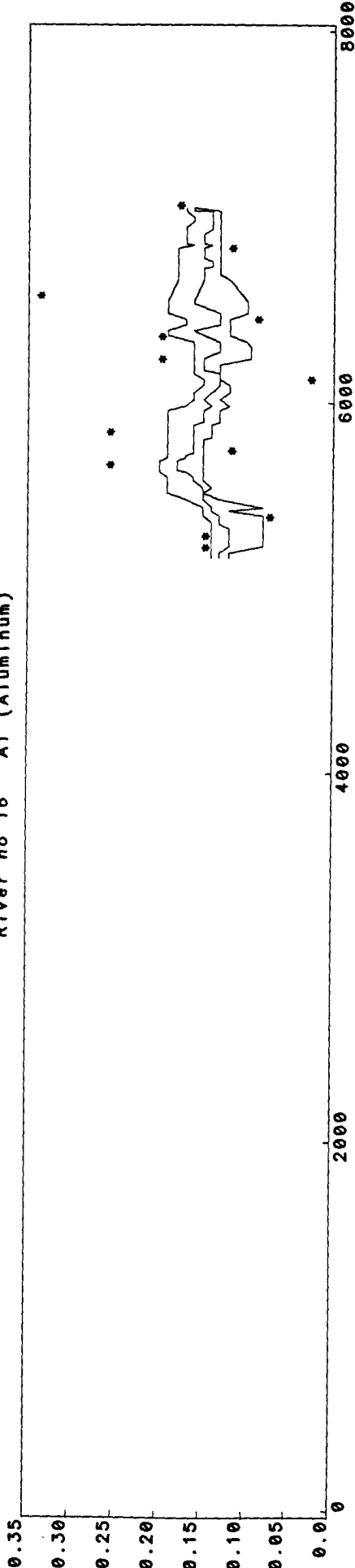

River no 17 Al (Aluminum)

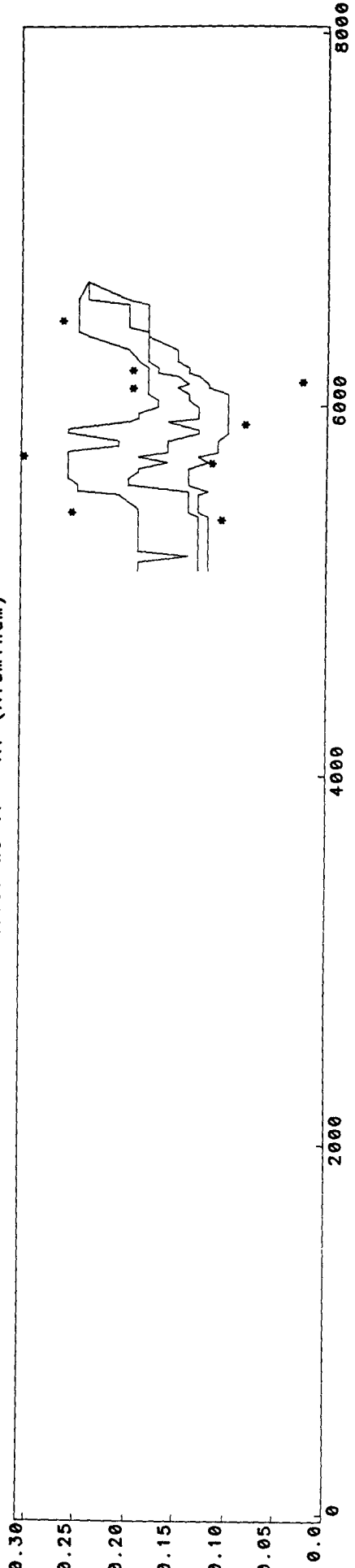

River no 18 Al (Aluminum)

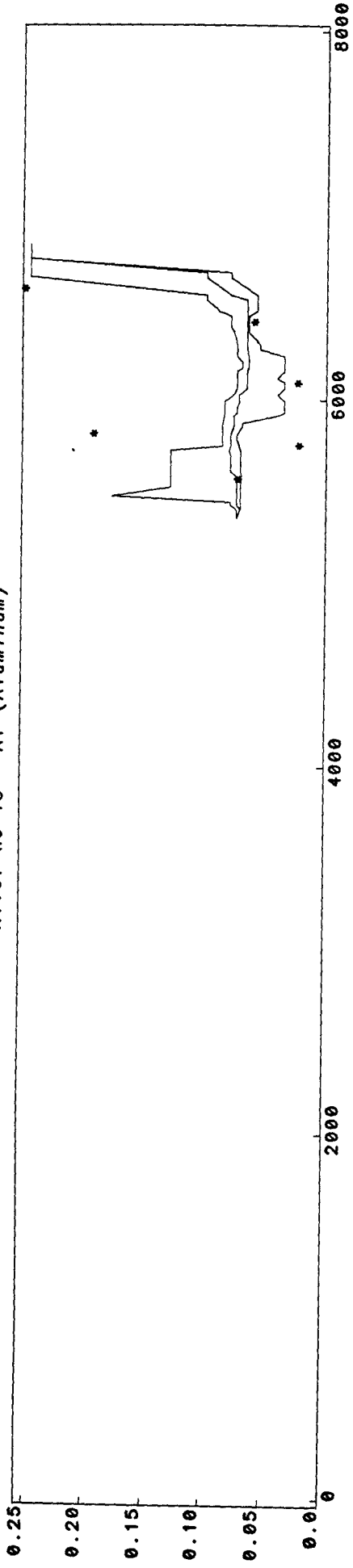

River no 19 Al (Aluminum)

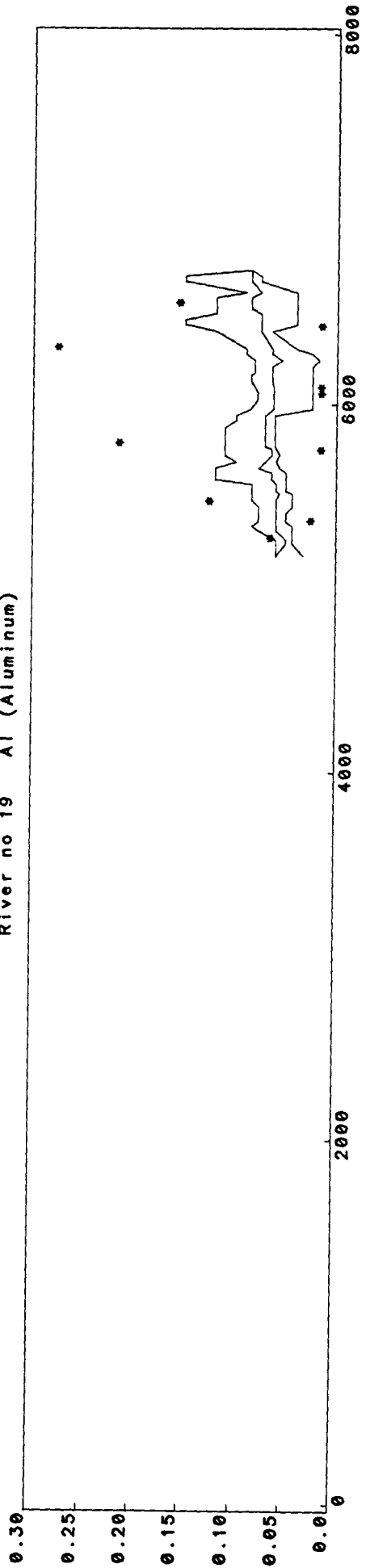

River no 21 Aluminum

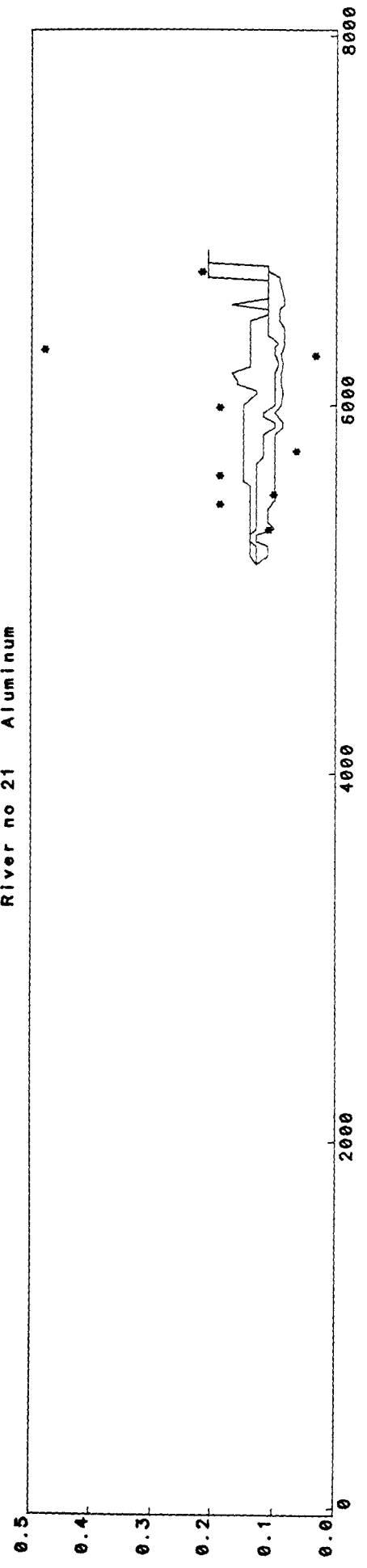

Julian Day  
River no 22 Aluminum

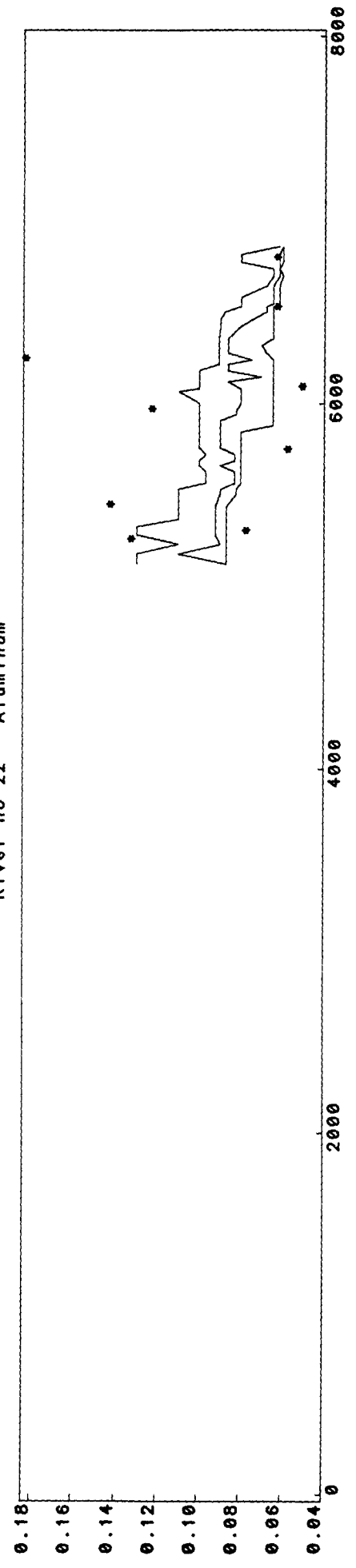

Julian Day  
River no 23 Aluminum

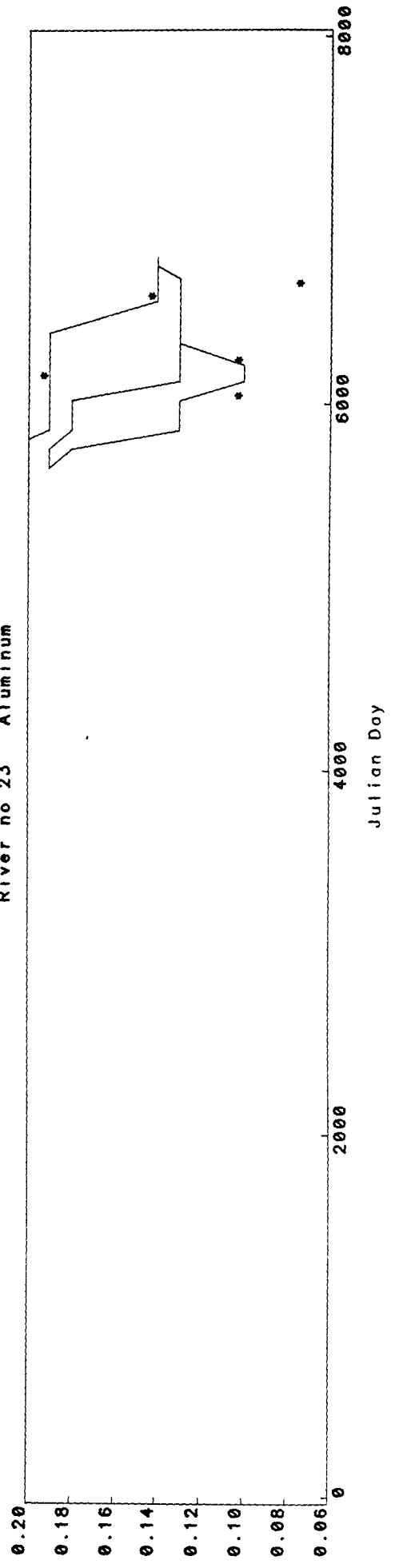

River no 25 Aluminum

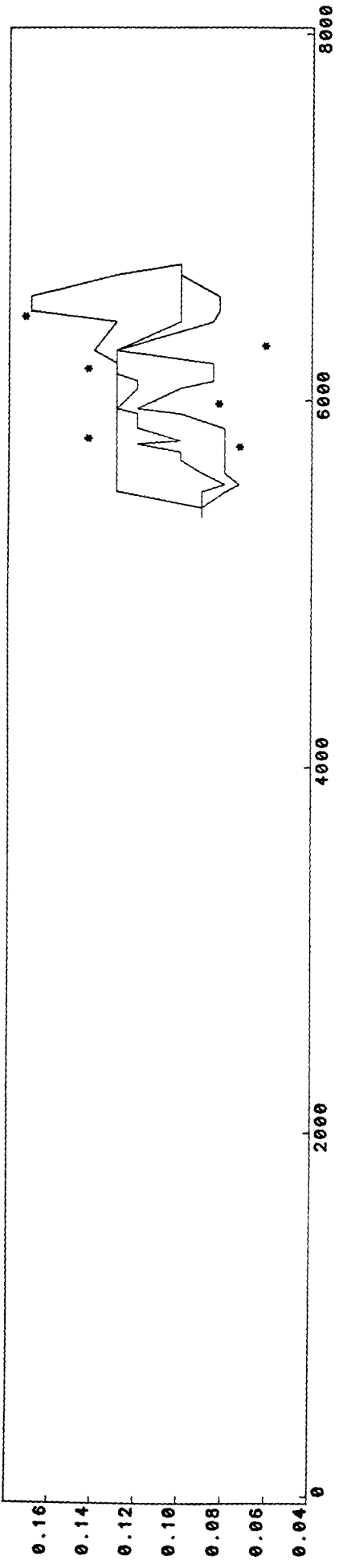

Julian Day  
River no 26 Aluminum

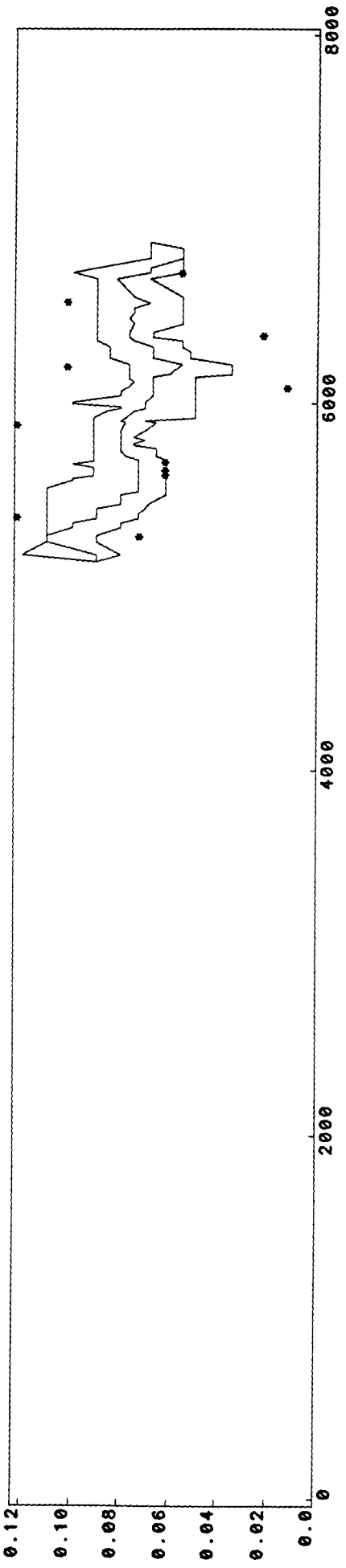

Julian Day  
River no 27 Aluminum

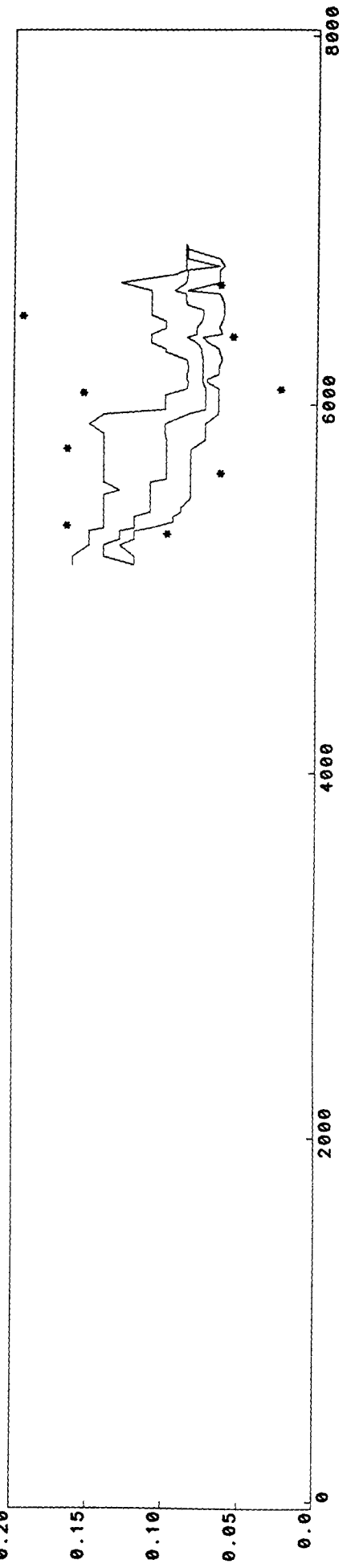



River no 28 Aluminum

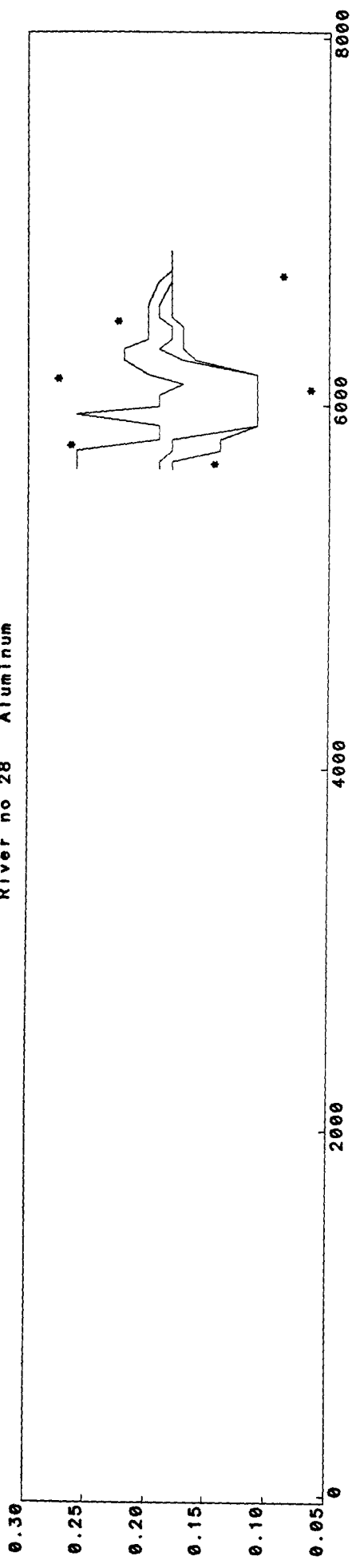

Appendix 20. Running boxplots of potassium for the study rivers.

River no 1 K (potassium)

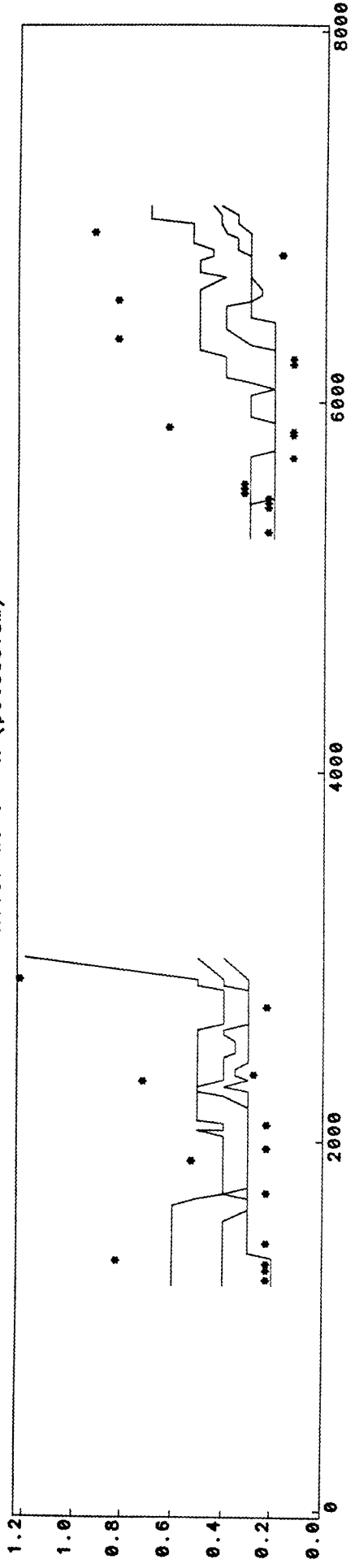

River no 2 K (potassium)

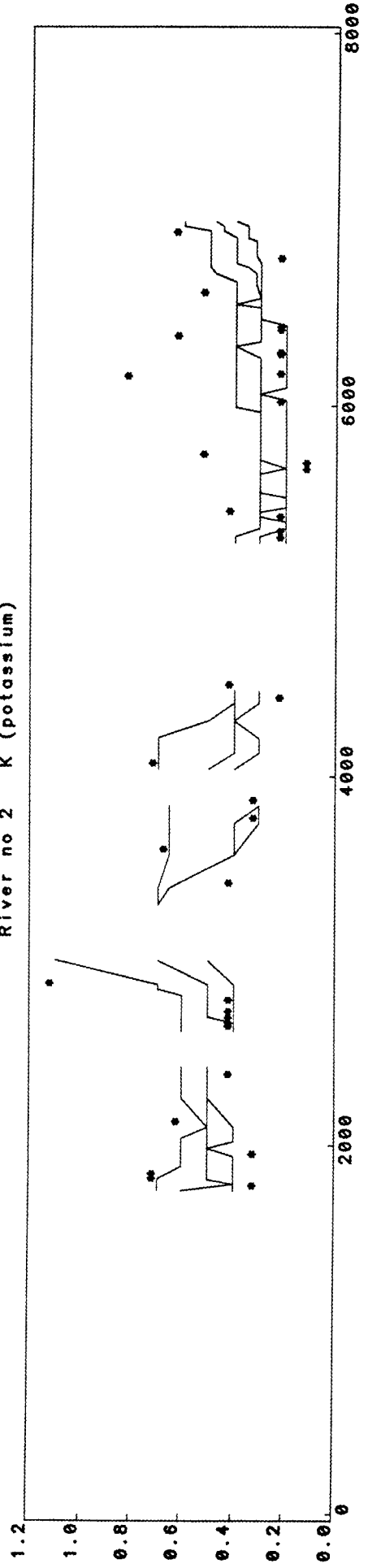

River no 3 K (potassium)

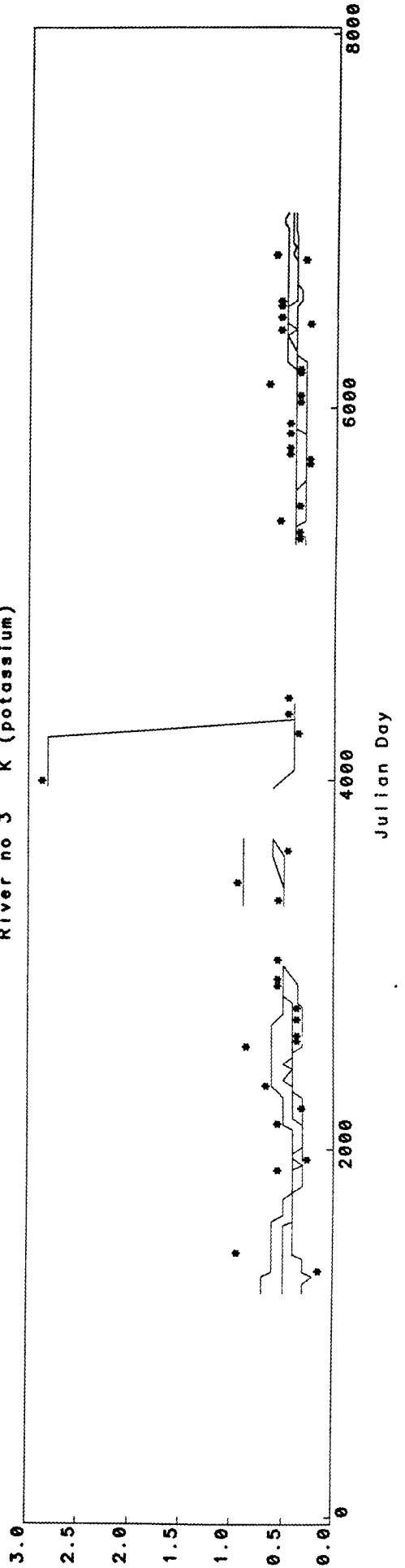

River no 4 K (potassium)

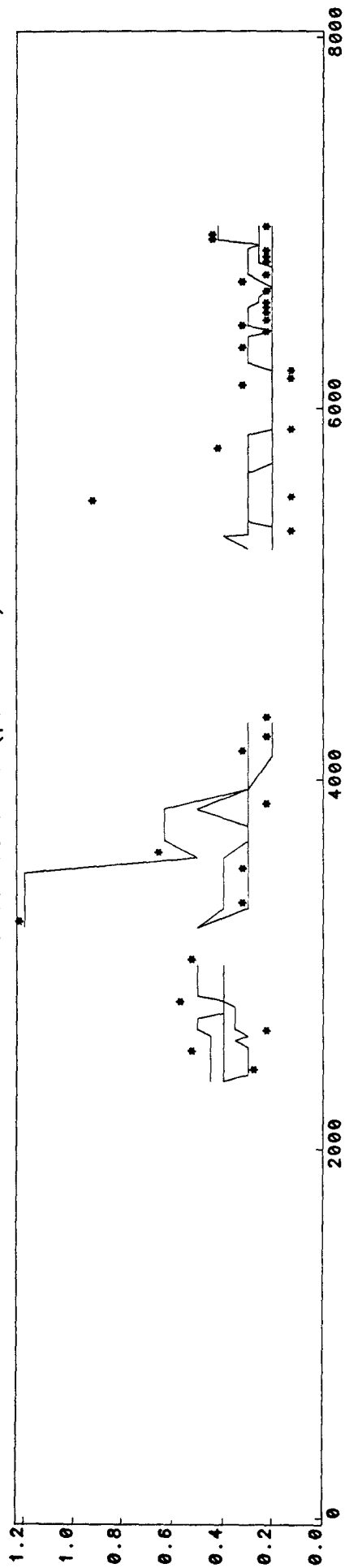

River no 5 K (potassium)

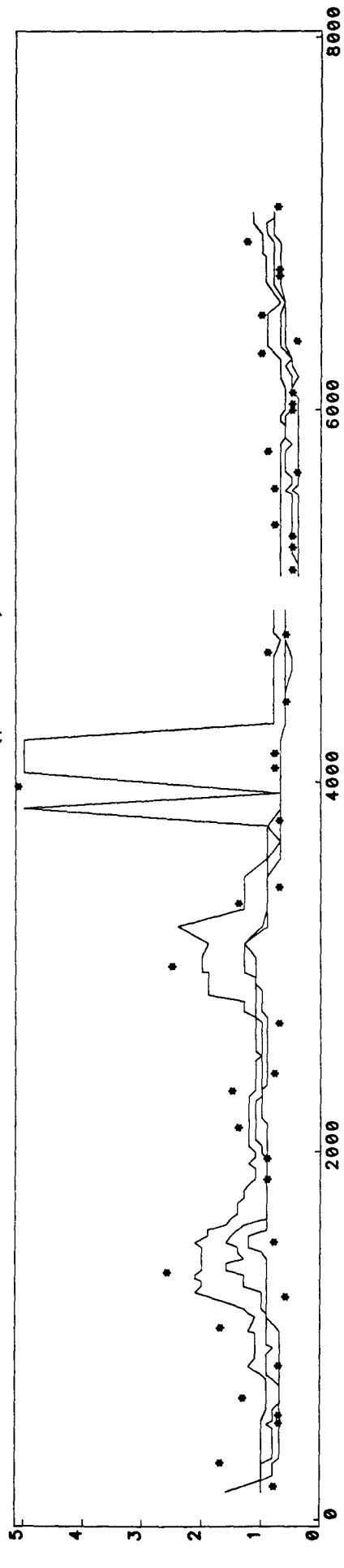

River no 6 K (potassium)

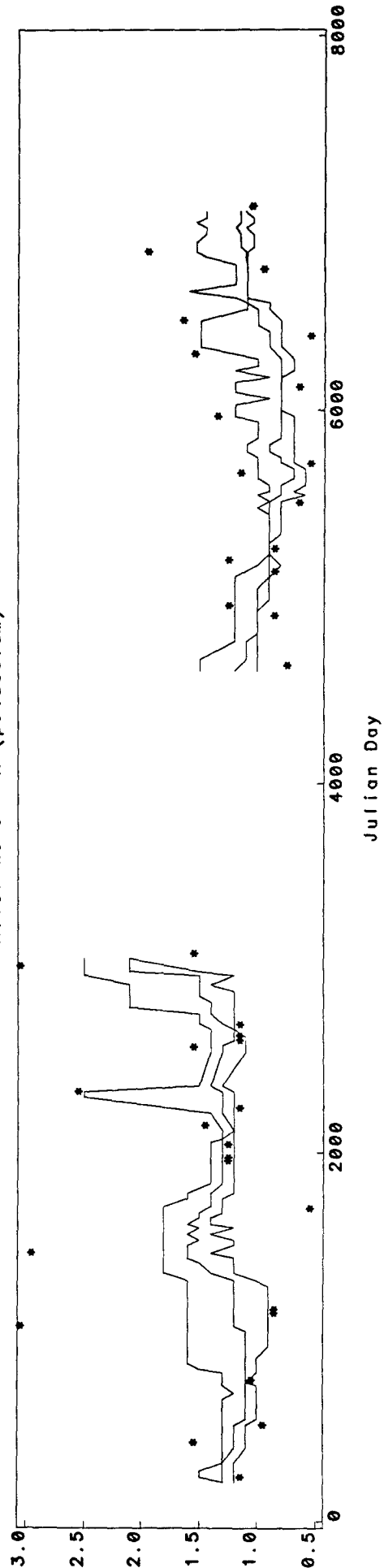

River no 7 K (potassium)

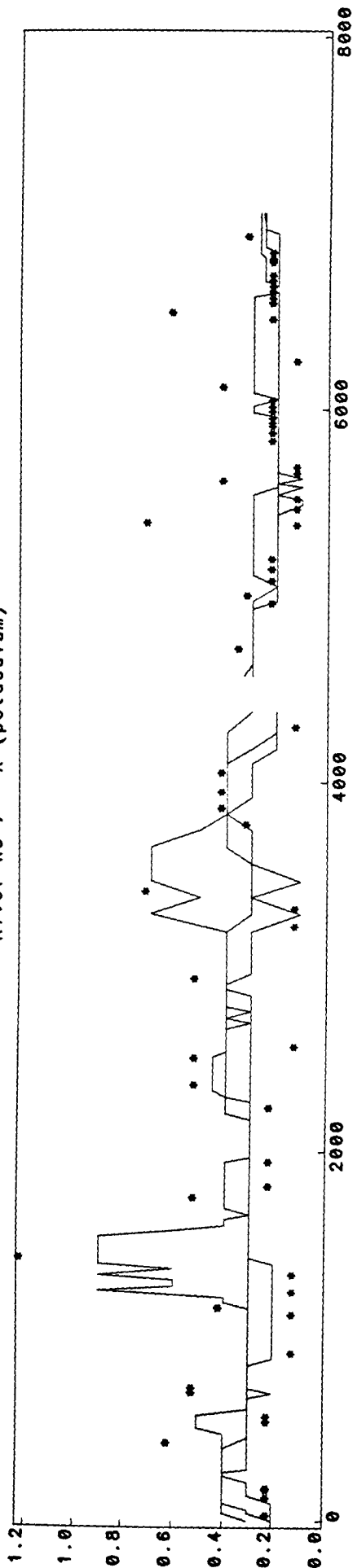

River no 8 K (potassium)

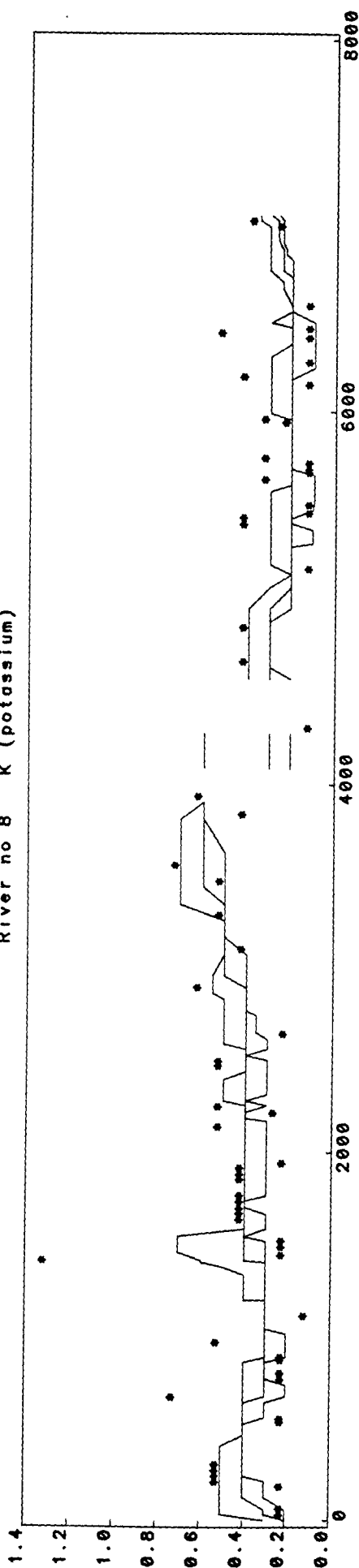

River no 9 K (potassium)

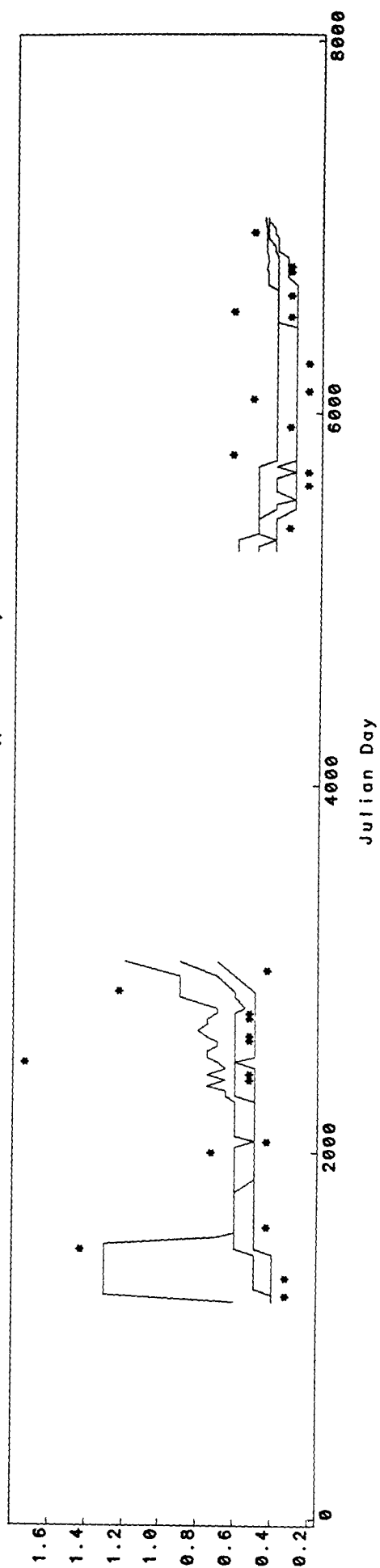

River no 10 K (potassium)

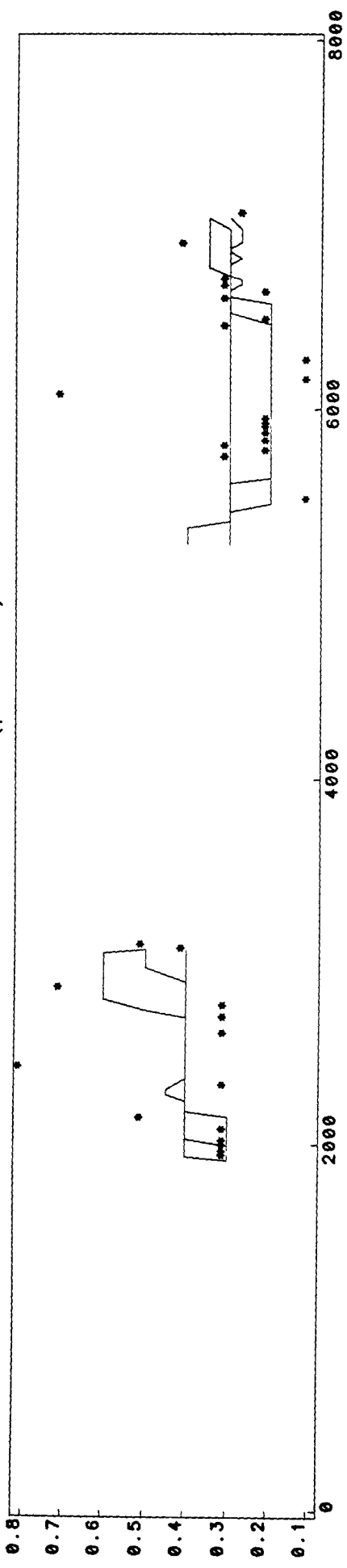

River no 11 K (potassium)

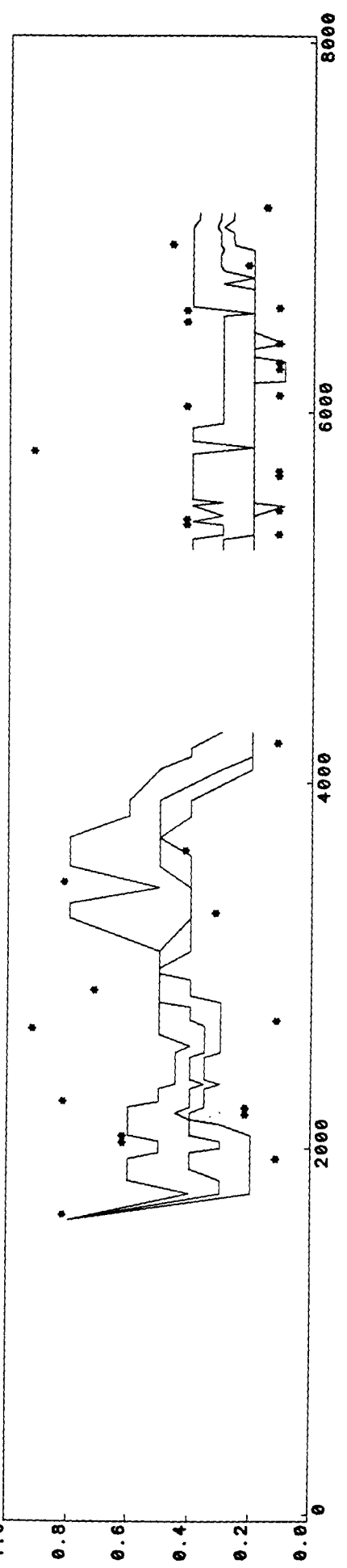

River no 12 K (potassium)

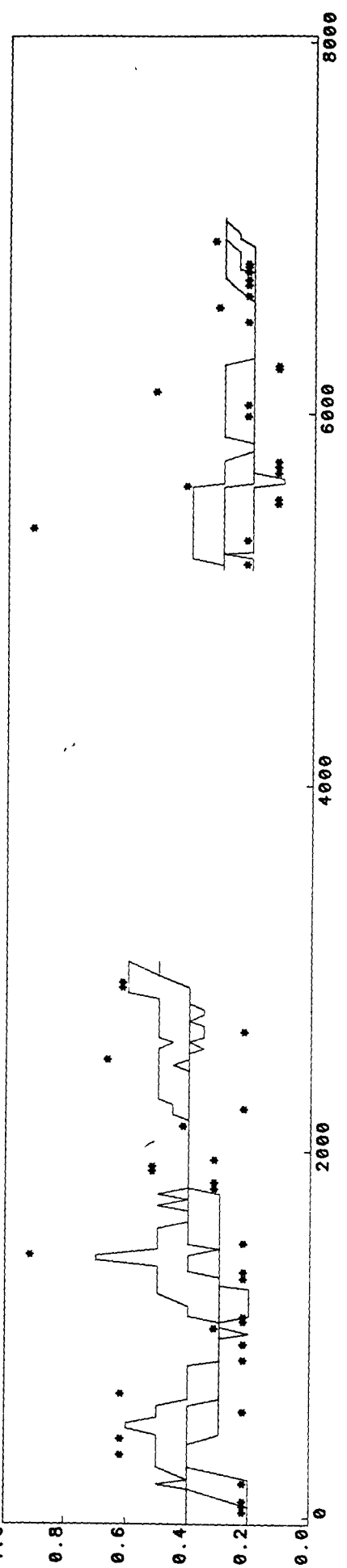

River no 13 K (potassium)

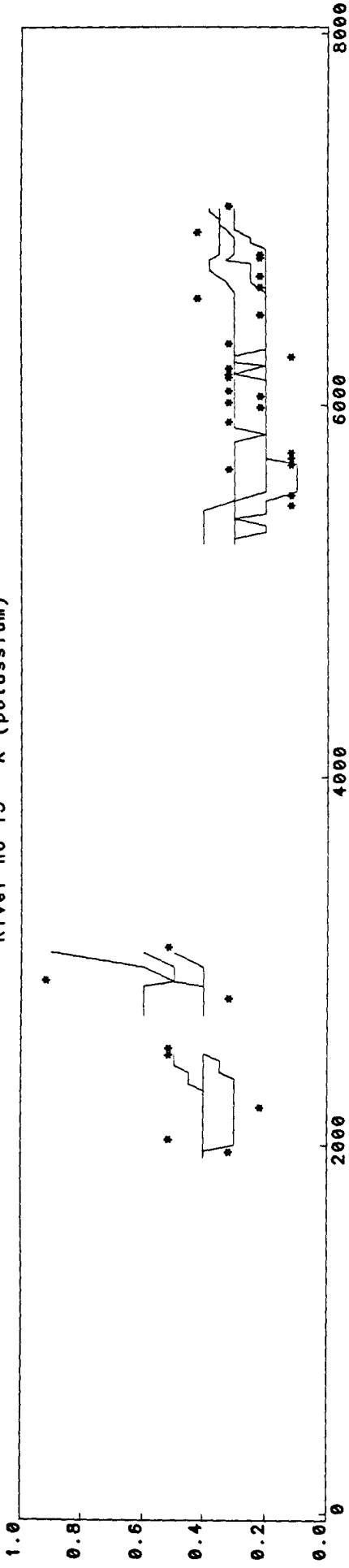

River no 16 K (potassium)

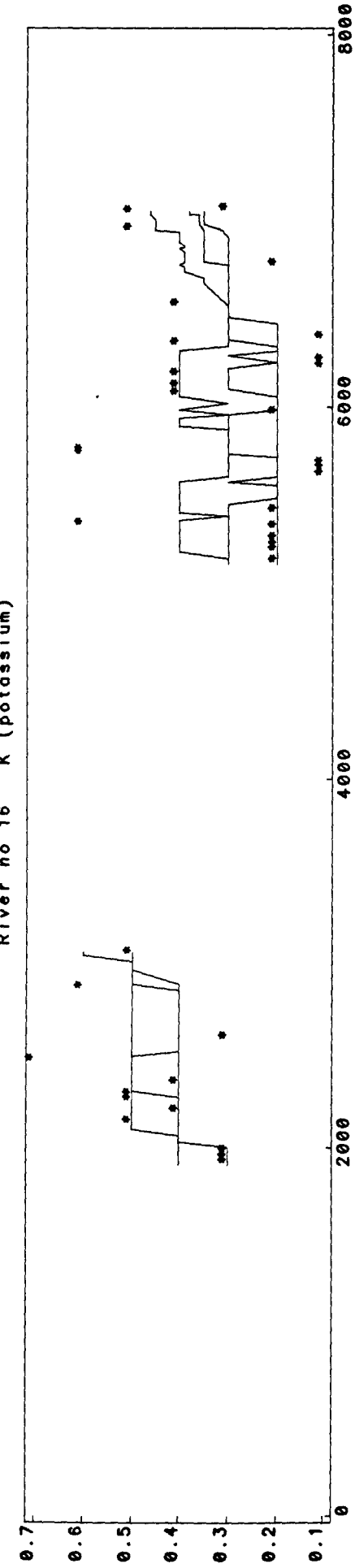

River no 17 K (potassium)

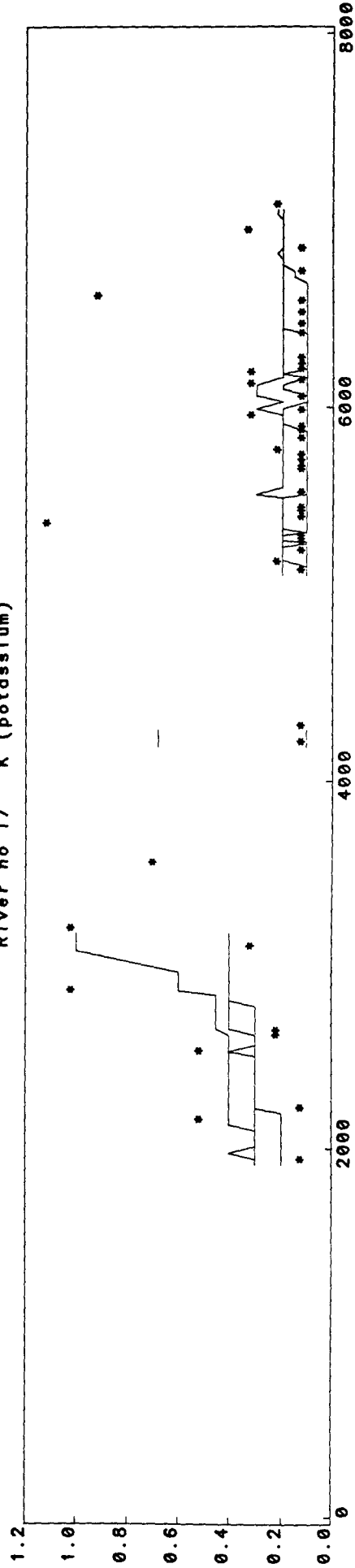

River no 18 K (potassium)

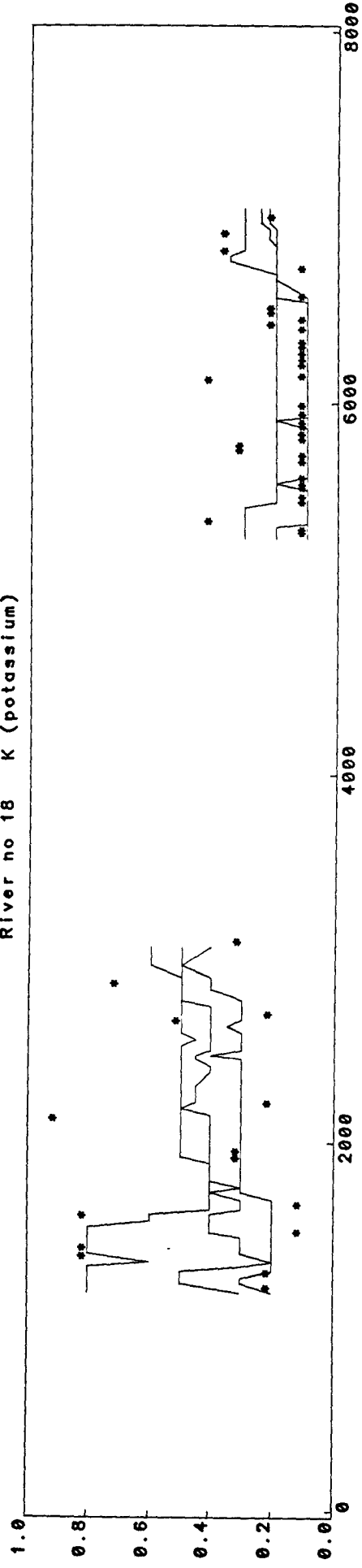

River no 19 K (potassium)

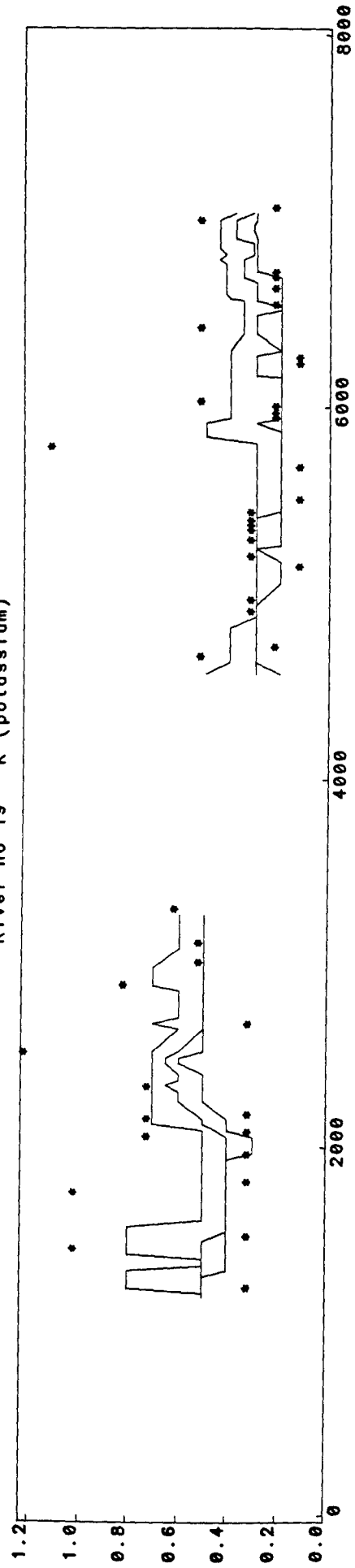

River no 20 K (potassium)

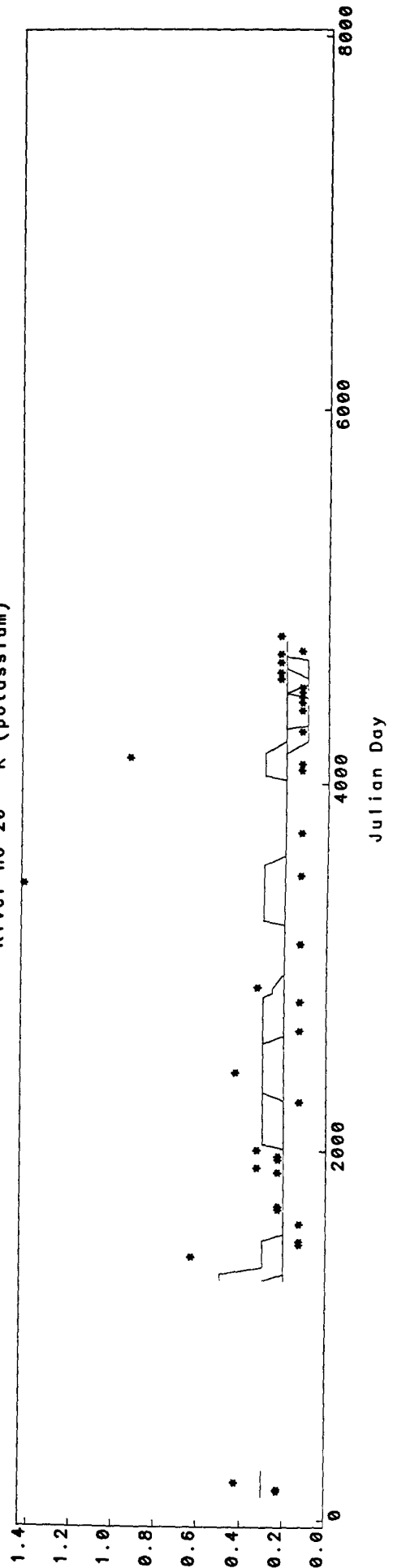



River no 21 K (potassium)

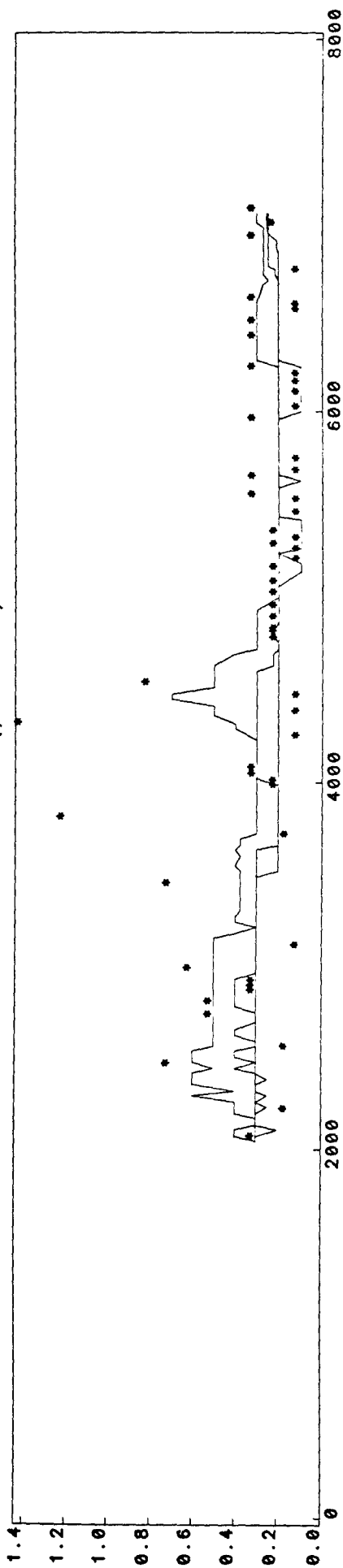

River no 22 K (potassium)

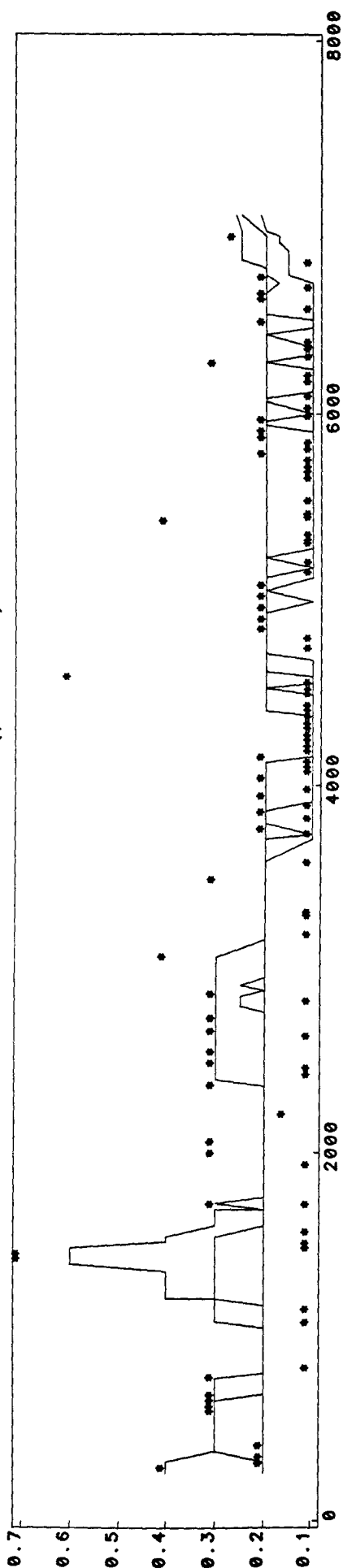

River no 23 K (potassium)

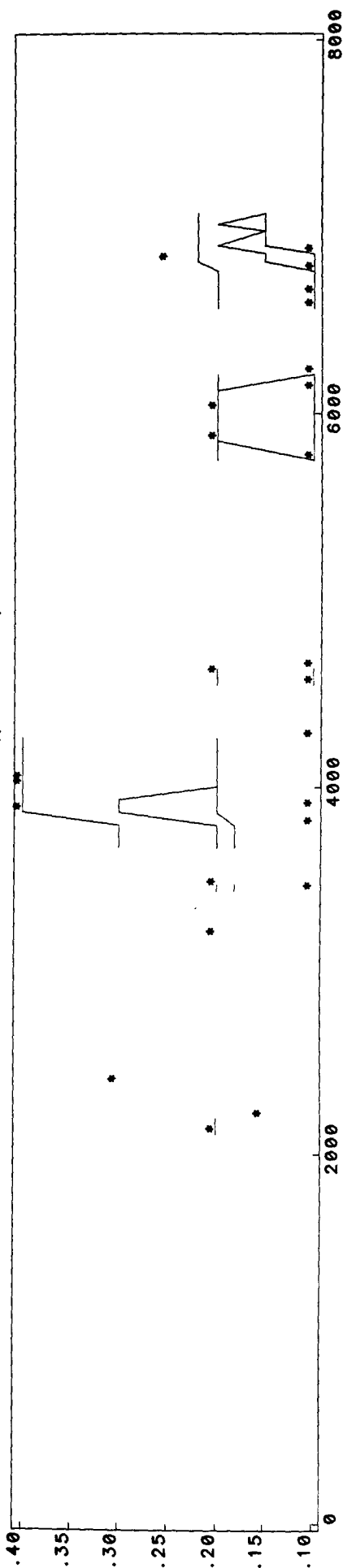

River no 25 K (potassium)

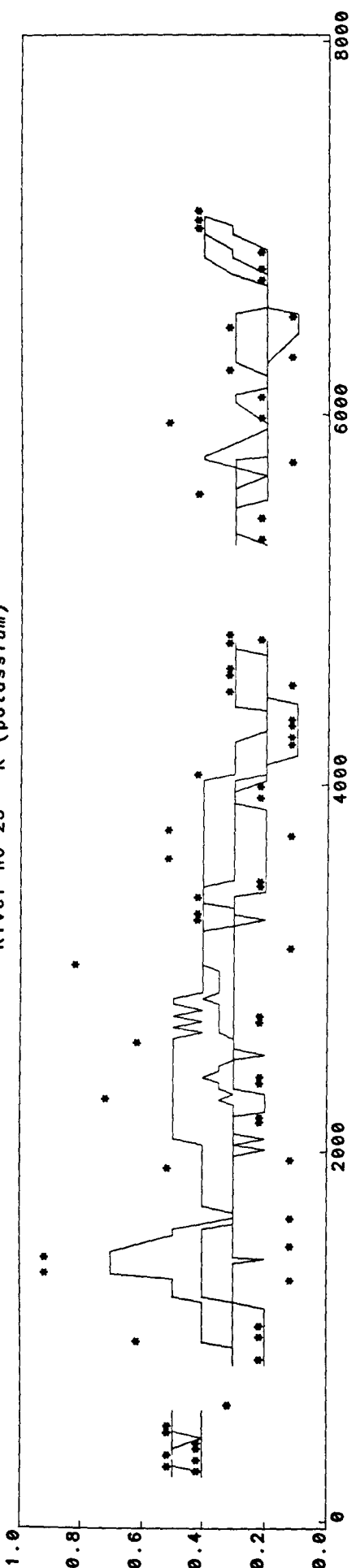

River no 26 K (potassium)

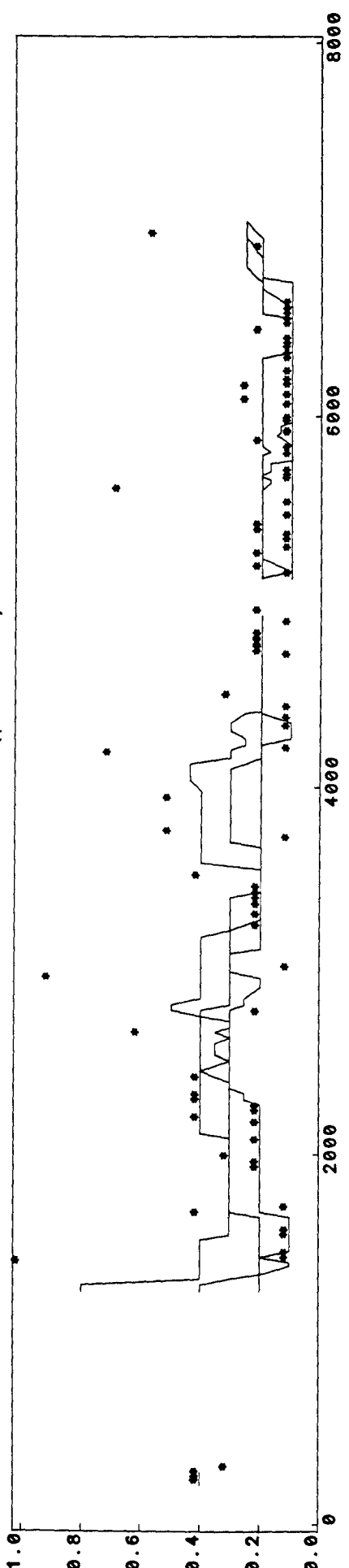

River no 27 K (potassium)

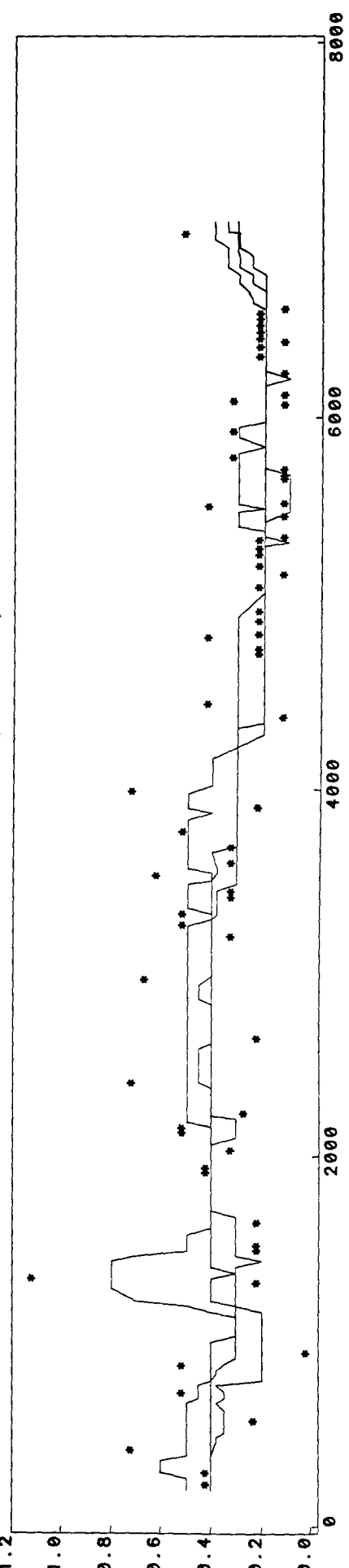

River no 28 K (potassium)

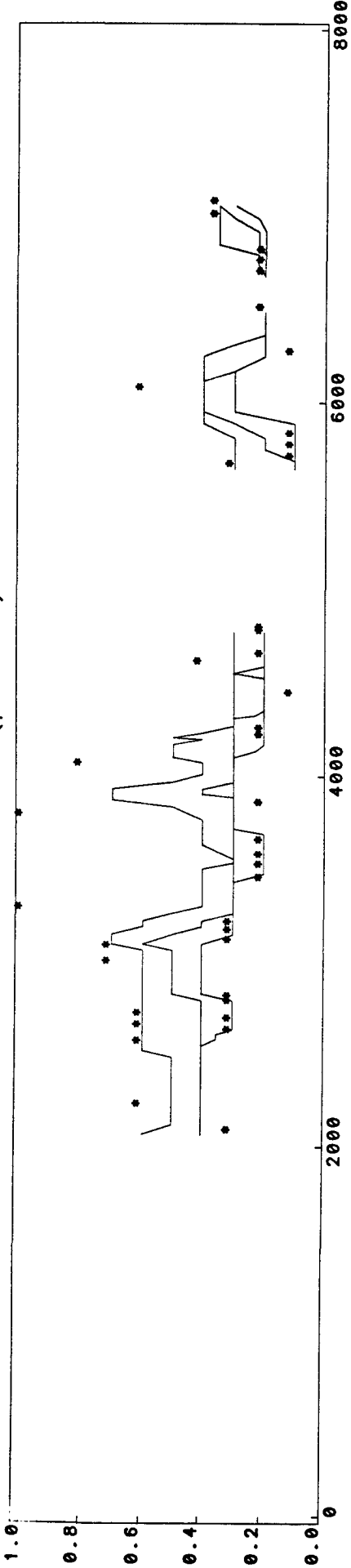

Julian Day

Appendix 21. Mean monthly and mean annual discharge for the study rivers.











# Lepreau River - OONBOIAQOOOI

	J	F	M	A	M	J	J	A	S	O	N	D	Annual	
1965	■	■	■	■	■	·	·	·	·	·	■	■	■	4.80
	·	·	■	■	■	·	·	·	·	■	■	■	■	4.57
	■	■	·	■	■	■	·	·	■	■	■	■	■	8.22
	·	■	■	■	■	·	·	·	·	■	■	■	■	5.69
1970	■	■	■	■	■	·	·	·	·	■	■	■	■	6.91
	■	■	■	■	■	■	■	■	■	■	■	■	■	7.08
	·	■	■	■	■	·	·	·	·	■	■	■	■	5.76
	■	·	■	■	■	■	·	·	·	■	■	■	■	9.33
1975	■	■	■	■	■	■	·	·	·	·	■	■	■	9.06
	■	■	■	■	■	■	·	·	·	■	■	■	■	6.76
	■	·	■	■	■	■	·	·	·	·	■	■	■	6.86
	■	■	■	■	■	·	·	·	·	■	■	■	■	8.73
1980	■	·	■	■	■	■	■	■	■	■	■	■	■	10.30
	■	■	■	■	■	·	·	·	·	■	■	·	■	6.63
	■	·	■	■	■	■	·	·	·	■	■	■	■	11.40
	■	■	■	■	■	■	·	·	·	·	■	■	■	7.02
1984	■	■	■	■	■	■	■	■	■	■	■	■	■	10.40
	■	■	■	■	■	■	·	·	·	·	■	■	■	6.59
	■	■	■	■	■	■	·	·	·	·	■	■	■	7.67
	■	■	■	■	■	■	·	·	·	·	■	■	■	7.27





# Pointe Wolfe River - OONBOIBV0015

	J	F	M	A	M	J	J	A	S	O	N	D	Annual
1965	■	■	■	■	■	.	.	.	.	■	■	■	3.85
	■	■	■	■	■	.	.	.	■	■	■	■	3.99
	■	.	.	■	■	■	■	■	■	■	■	■	6.26
	■	■	■	■	.	■	.	.	.	■	■	■	4.27
	■	■	■	■	■	■	■	.	■	■	■	■	5.30
1970	.	■	■	■	■	■	■	■	■	■	.	■	4.94
	.	■	■	■	■	.	.	■	■	■	■	■	4.62
	■	.	■	■	■	■	■	.	■	■	■	■	6.87
	■	■	■	■	■	■	■	.	.	■	■	■	6.26
	■	■	■	■	■	■	■	.	■	■	■	■	4.96
1975	.	.	■	■	■	■	.	.	■	■	■	■	5.71
	■	■	■	■	■	.	■	■	■	■	■	■	6.36
	.	.	■	■	■	■	■	■	■	■	■	■	6.24
	■	■	■	■	■	■	.	.	.	■	■	.	4.32
	■	.	■	■	■	■	■	■	■	■	■	■	7.87
1980	■	.	■	■	■	■	■	■	■	■	■	■	4.71
	.	■	■	■	■	■	■	.	■	■	■	■	7.82
	■	■	■	■	■	■	■	■	.	■	■	■	4.52
	■	■	■	■	■	■	■	.	.	■	■	■	5.08
1984	■	■	■	■	■	■	■	.	.	.	■	5.00	







# Wallace River - OONSOIDN000I

	J	F	M	A	M	J	J	A	S	O	N	D	Annual
1965	■	■	■	■	■	■	·	·	·	·	■	■	5.68
	·	·	■	■	■	■	·	·	·	■	■	■	6.06
	■	·	■	■	■	■	·	·	·	■	■	■	10.20
	■	·	■	■	■	■	·	·	·	·	■	■	7.27
	■	■	■	■	■	■	·	·	·	·	■	■	6.77
1970	■	■	·	■	■	■	■	■	■	■	■	■	7.66
	·	■	■	■	■	■	·	■	·	■	■	■	10.90
	■	■	■	■	■	■	·	·	·	■	■	■	11.70
	■	■	■	■	■	■	■	■	·	·	■	■	7.93
	·	■	■	■	■	■	■	·	·	■	■	■	8.94
1975	■	·	■	■	■	■	·	·	·	·	■	■	7.94
	■	■	■	■	■	·	·	·	·	■	■	■	8.35
	■	·	■	■	■	■	■	■	■	■	■	■	12.30
	■	■	■	■	■	■	·	·	·	·	■	■	8.00
	■	■	■	■	■	■	■	■	■	■	■	■	13.30
1980	■	·	■	■	■	■	·	·	·	·	■	■	7.50
	■	■	■	■	■	■	·	·	·	■	■	■	11.00
	■	■	■	■	■	■	·	·	·	·	■	■	8.27
	■	■	■	■	■	■	■	·	·	·	■	■	8.86
1984	■	■	■	■	■	■	·	·	·	·	■	■	9.16











# Rocky River - OONF02ZK0001

J F M A M J J A S O N D Annual

Year	J	F	M	A	M	J	J	A	S	O	N	D	Annual
1965	■	■	■	■	■	■	·	·	■	■	■	■	-
	■	■	■	■	■	■	■	■	■	■	■	■	-
	■	■	■	■	·	·	·	■	■	■	■	■	-
	■	■	■	■	■	■	■	■	■	■	■	■	-
1970	■	■	■	■	■	■	■	■	■	■	■	■	-
	■	■	■	■	■	·	■	■	■	■	■	■	-
	■	■	■	■	■	■	■	■	■	■	■	■	-
	■	■	■	■	■	·	·	■	■	■	■	■	11.80
1975	■	■	■	■	■	■	■	■	■	■	■	■	12.10
	■	■	■	■	■	■	■	■	■	■	■	■	12.30
	·	■	■	■	■	·	■	■	■	■	■	■	10.30
	■	■	■	■	■	■	·	■	■	■	■	■	12.20
1980	■	■	■	■	■	■	■	■	■	■	■	■	8.28
	■	■	■	■	■	■	·	■	■	■	■	■	12.30
	■	■	■	■	■	■	■	■	■	■	■	■	10.90
	■	■	■	■	■	■	■	■	■	■	■	■	14.90
1984	■	■	■	■	■	■	■	■	■	■	■	■	12.90
	■	■	■	■	■	■	■	■	■	■	■	■	10.90
	■	■	■	■	■	■	■	■	■	■	■	■	12.00
1984	■	■	■	■	■	·	■	■	■	■	■	11.30	











# Medway River - OONSOIEE000I

	J	F	M	A	M	J	J	A	S	O	N	D	Annual
1965	■	■	■	■	■	·	·	·	·	■	■	■	21.70
	■	■	■	■	■	·	·	·	■	■	■	■	25.30
	■	■	■	■	■	■	■	■	■	■	■	■	53.70
	■	■	■	■	■	■	·	·	·	■	■	■	37.70
	■	■	■	■	■	■	·	·	·	■	■	■	36.50
1970	■	■	■	■	■	■	■	■	■	■	■	■	35.20
	■	■	■	■	■	·	■	■	■	■	■	■	48.70
	■	■	■	■	■	■	·	·	■	■	■	■	53.60
	■	■	■	■	■	■	■	■	·	■	■	■	47.10
	■	■	■	■	■	■	·	■	■	■	■	■	45.80
1975	■	■	■	■	■	·	·	·	■	■	■	■	39.60
	■	■	■	■	■	■	■	·	■	■	■	■	46.60
	■	■	■	■	■	■	■	■	■	■	■	■	49.90
	■	■	■	■	■	■	·	·	·	■	■	■	30.90
	■	■	■	■	■	■	■	■	■	■	■	■	55.90
1980	·	■	■	■	■	■	·	·	·	■	■	■	33.60
	■	■	■	■	■	■	■	·	■	■	■	■	50.50
	■	■	■	■	■	■	■	·	·	■	■	■	34.80
	■	■	■	■	■	■	·	·	·	■	■	■	39.00
1984	■	■	■	■	■	■	·	·	·	·	■	■	39.10



# Clam Hbr. River - OONSOIEROOOI

	J	F	M	A	M	J	J	A	S	O	N	D	Annual
1965	■	■	■	■	■	·	■	·	·	■	■	■	1.26
	■	■	■	·	·	·	·	■	■	■	■	■	1.27
	·	■	■	■	■	·	·	·	■	■	■	■	2.08
	·	■	■	■	■	·	■	■	·	■	■	■	1.68
	■	■	■	■	■	·	·	·	■	■	■	■	1.96
1970	■	·	■	■	■	■	■	■	■	■	■	■	1.41
	■	■	■	■	·	·	·	·	■	■	■	■	2.08
	■	■	■	■	■	·	·	·	■	■	■	■	2.34
	■	■	■	■	■	·	·	·	·	■	■	■	1.70
	■	■	■	■	·	·	·	·	■	■	■	■	1.32
1975	·	■	■	■	■				■	■	■	■	1.66
	■	■	■	■	·	·	·	·	■	■	■	■	1.49
	■	■	■	■	■	■	■	■	■	■	■	■	1.75
	·	■	■	■	·	·		·	■	·	■	■	1.08
	■	■	■	■	■	·	■	·	■	■	■	■	1.59
1980	·	■	■	■	·	·	·	·	■	■	■	■	1.54
	■	■	■	■	■	■	·	·	■	■	■	■	-
	■	■	■	■	■	·	·	·	·	■	■	■	1.72
	■	■	■	■	■	■	■	■	·	■	■	■	1.95
1984	■	■	■	■	■	·	·	·	■	■	■	1.41	

Appendix 22. Use of various methods of chemical analysis during the period of record. The Exploits River is taken as being representative.

EXPLOITS RIVER METHODS OF ALKALINITY ANALYSIS

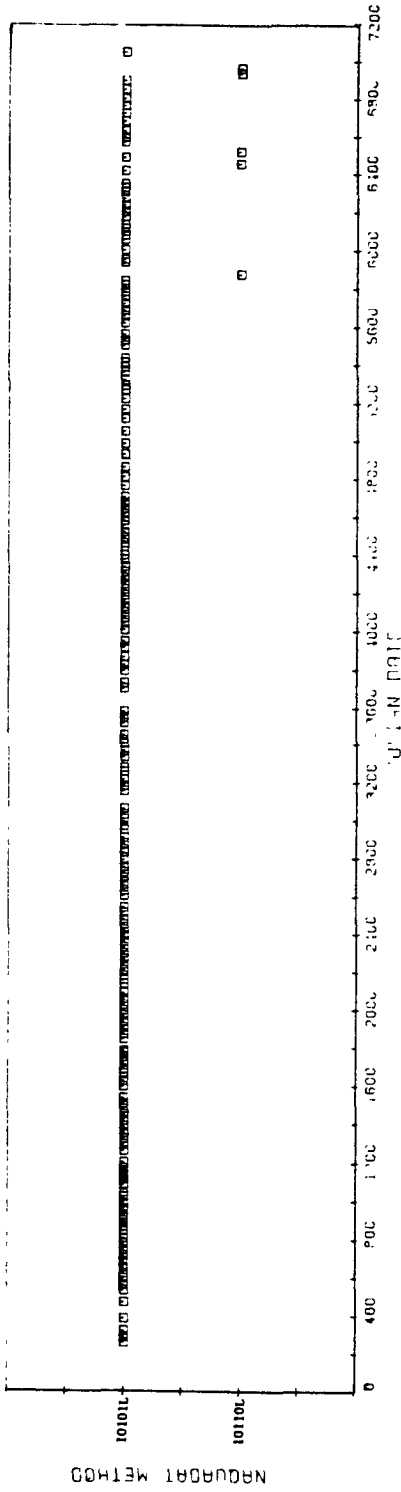

EXPLOITS RIVER METHODS OF CALCIUM ANALYSIS

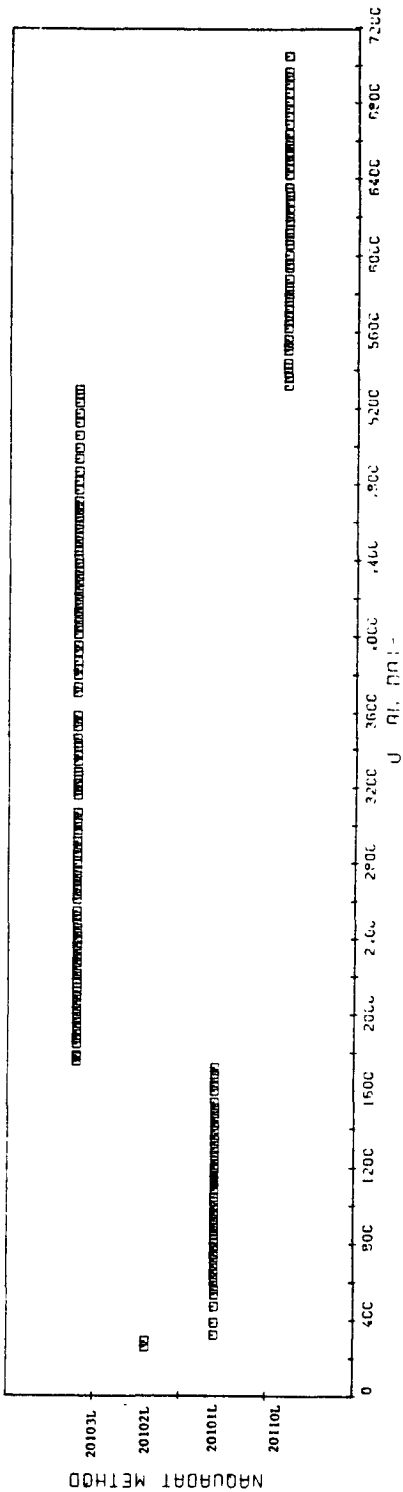

EXPLOITS RIVER METHODS OF MAGNESIUM ANALYSIS

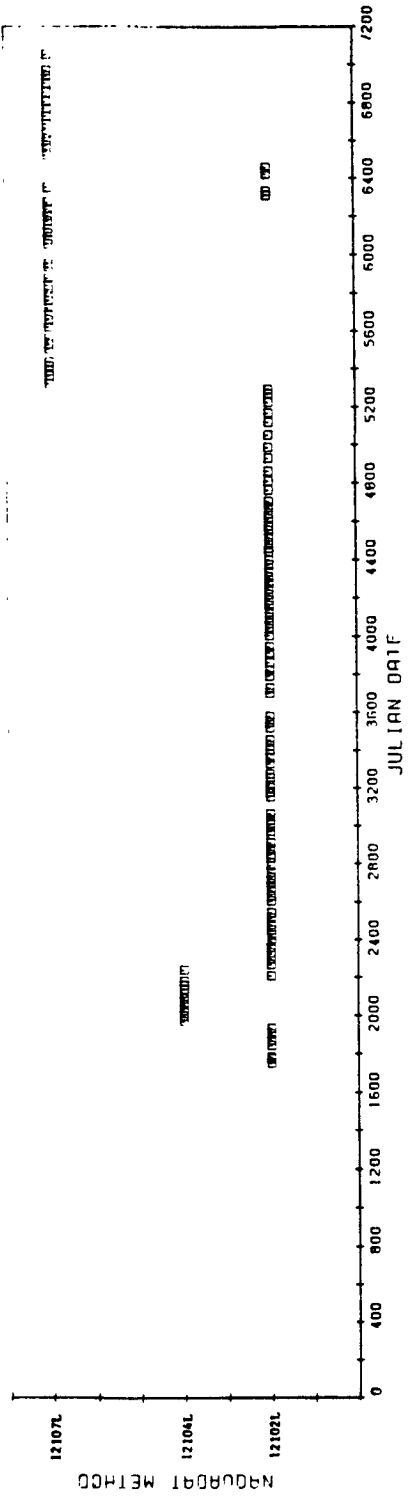

EXPLOITS RIVER METHODS OF POTASSIUM ANALYSIS

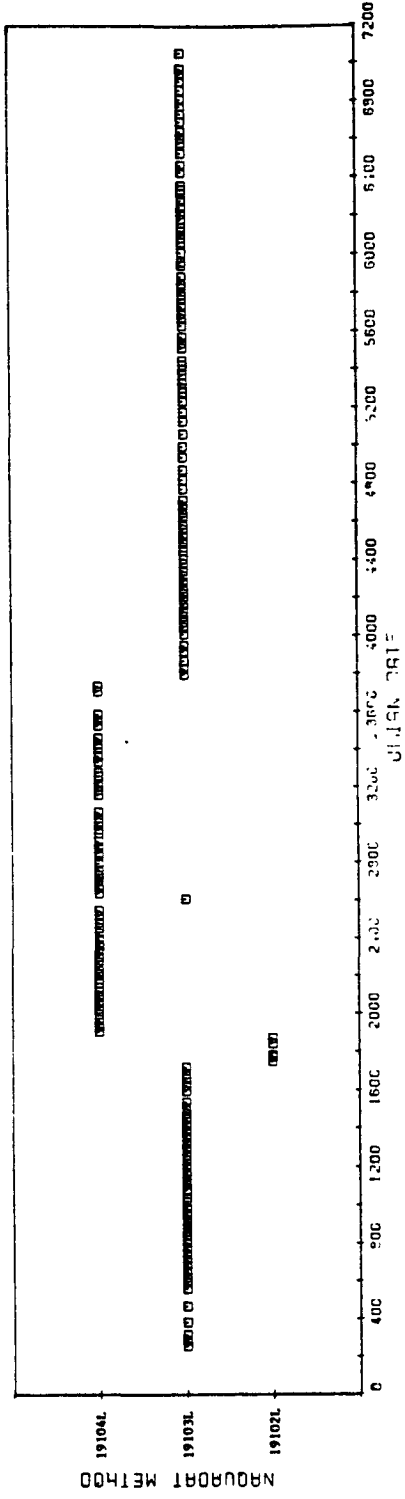

EXPLOITS RIVER METHODS OF SOLUBLE ANALYSIS

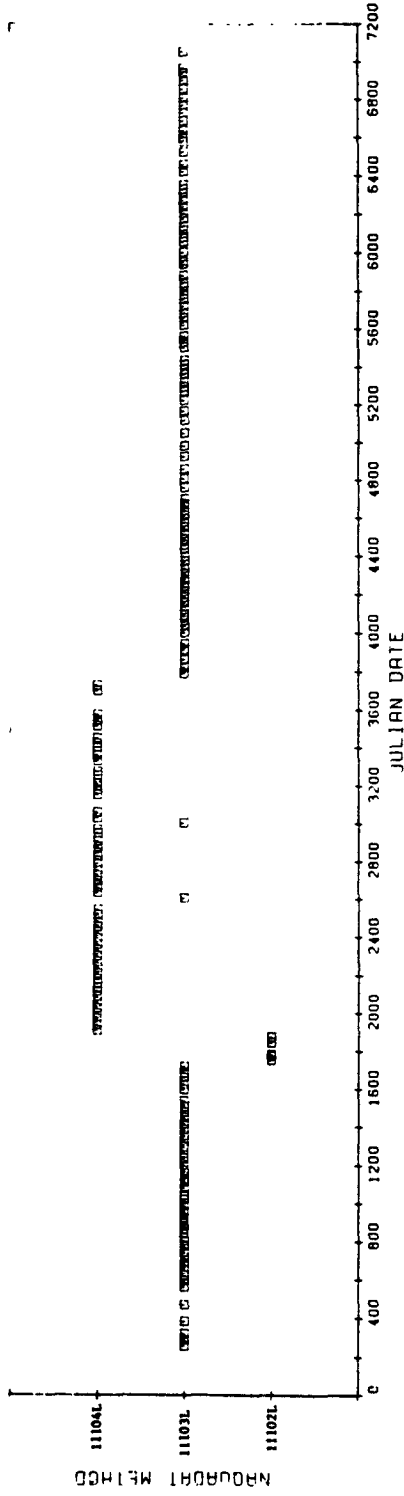

EXPLOITS RIVER METHODS OF CHLORIDE ANALYSIS

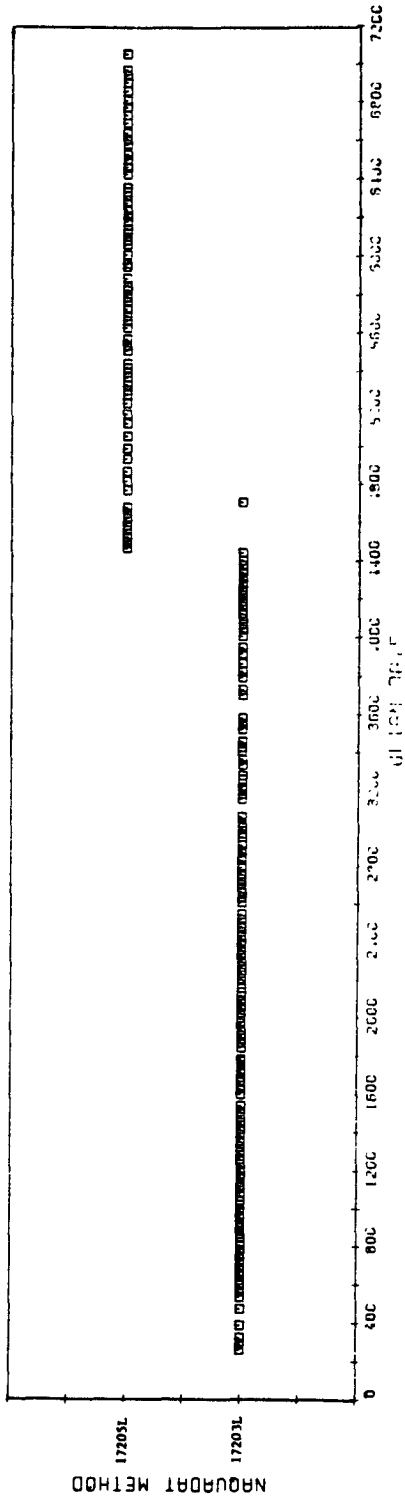



EXPLOITS RIVER METHODS OF SULPHATE ANALYSIS

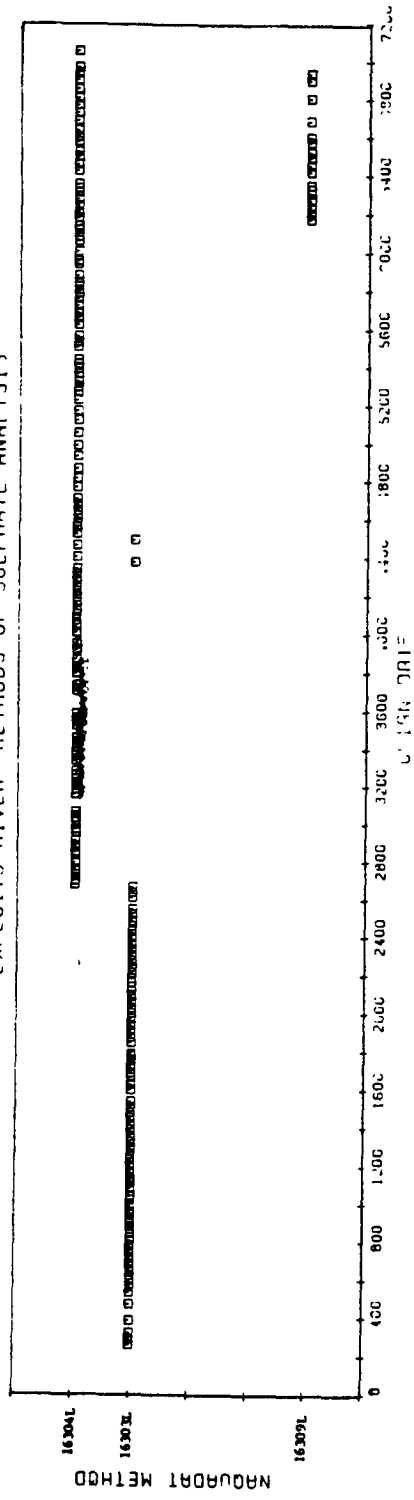

EXPLOITS RIVER METHODS OF NITRATE ANALYSIS

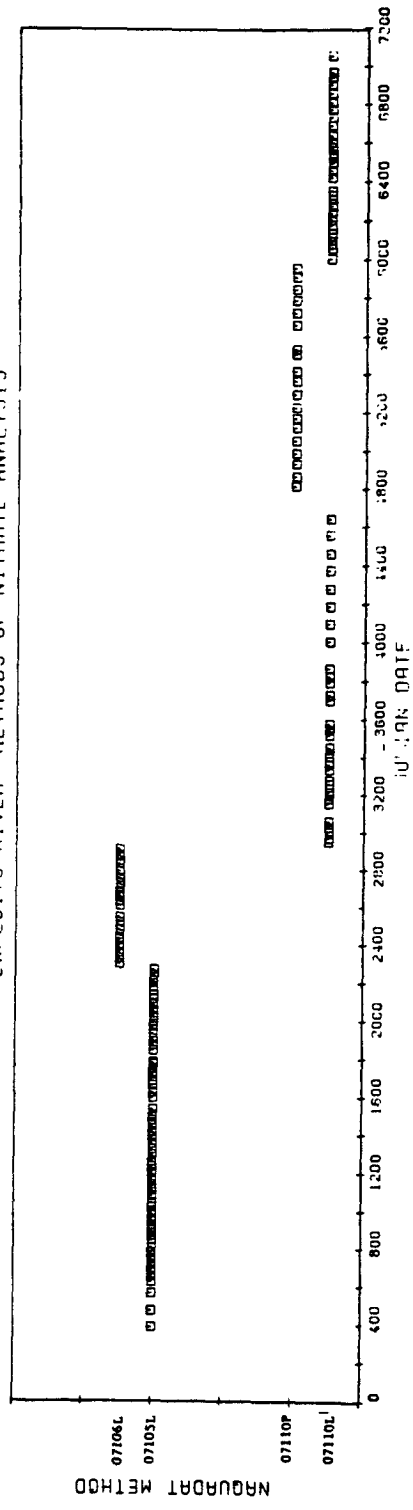

EXPLOITS RIVER METHODS OF 'DOC' ANALYSIS

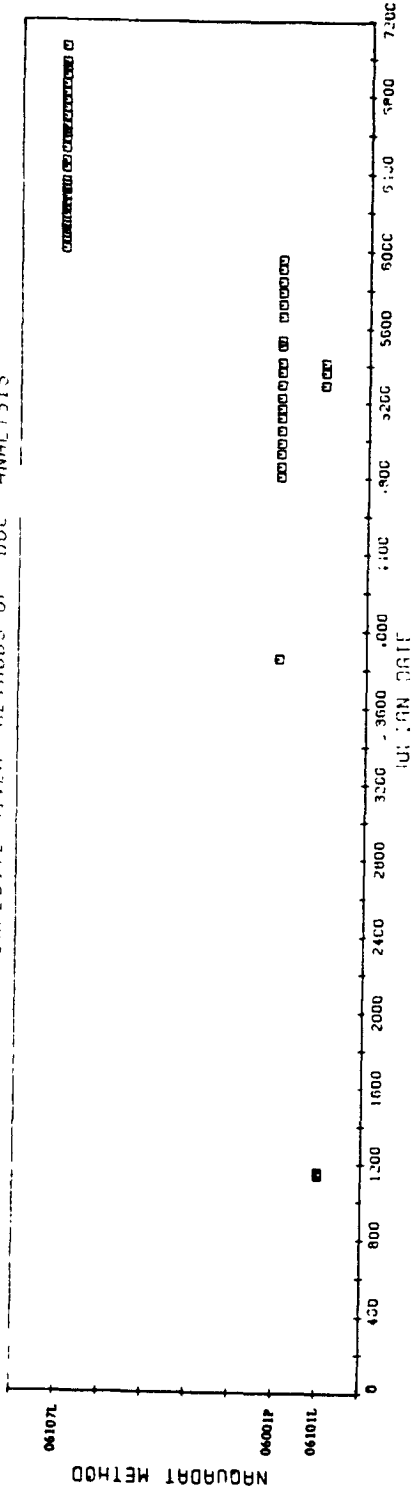

EXPLOITS RIVER METHODS OF ALUMINIUM ANALYSIS

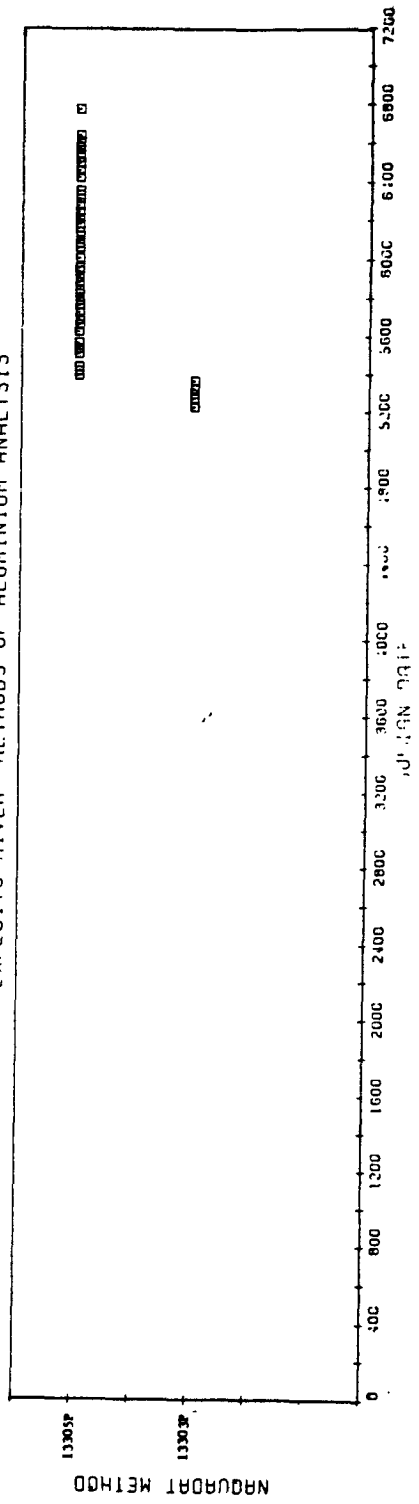

EXPLOITS RIVER ..METHODS OF IRON ANALYSIS

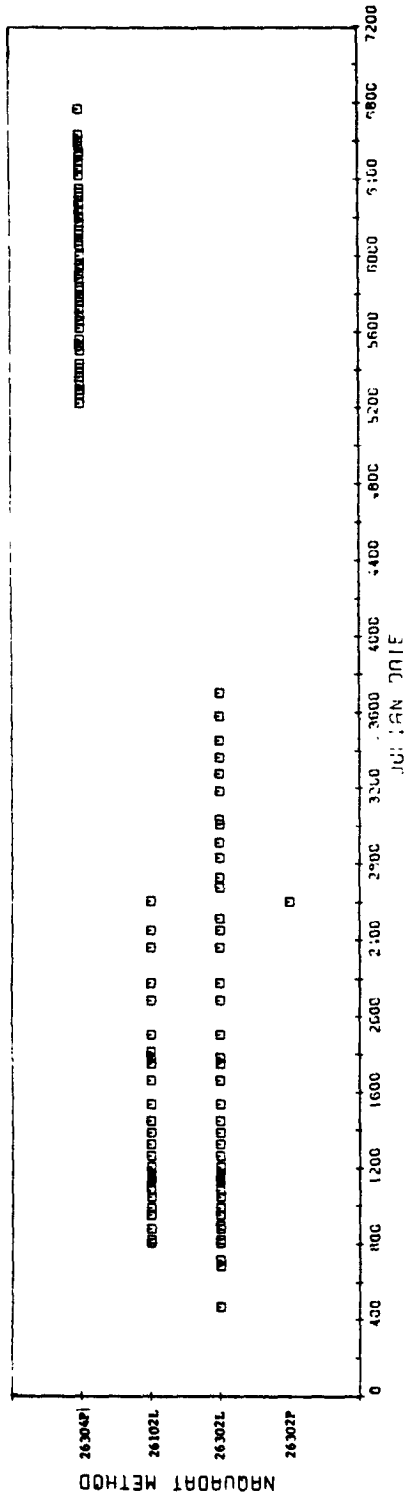

EXPLOITS RIVER METHODS OF MANGANESE ANALYSIS

