

# Aircraft Full-Scale Test Program for the 1999-2000 Winter

## Evaluation of the Positioning of Surface-Mounted Ice Detection Sensors on the Bombardier CL-65 Aircraft



Prepared for

**Transportation Development Centre**

On behalf of

**Civil Aviation**

**Transport Canada**



December 2000

# Aircraft Full-Scale Test Program for the 1999-2000 Winter

## Evaluation of the Positioning of Surface-Mounted Ice Detection Sensors on the Bombardier CL-65 Aircraft



by

Marc Hunt and  
Medhat Hanna



December 2000



Final Version 1.0

The contents of this report reflect the views of APS Aviation Inc. and not necessarily the official view or opinions of the Transportation Development Centre of Transport Canada or other sponsors.

The Transportation Development Centre does not endorse products or manufacturers. Trade or manufacturers' names appear in this report only because they are essential to its objectives.

### DOCUMENT ORIGIN AND APPROVAL RECORD

Prepared by:	Marc Hunt and Medhat Hanna
--------------	----------------------------

Reviewed by:	 _____ John D'Avirro Program Manager	<u>JAN 10, 2003</u> Date
Approved by:	 _____ R.V. Potter, Ph.D. Vice-President Programs & QA	<u>4 Jan/03</u> Date

Un sommaire français se trouve avant la table des matières.

## PREFACE

At the request of the Transportation Development Centre of Transport Canada, APS Aviation Inc. has undertaken a research program to advance aircraft ground de/anti-icing technology. The specific objectives of the APS test program are the following:

- To develop holdover time data for Type IV fluids using lowest-qualifying viscosity samples, and to develop holdover time data for all newly qualified de/anti-icing fluids;
- To conduct flat plate holdover time tests under conditions of frost;
- To further evaluate the flow of contaminated fluid from the wing of a Falcon 20D aircraft during simulated takeoff runs;
- To determine the patterns of frost formation and of fluid failure initiation and progression on the wings of commercial aircraft;
- To evaluate whether the proposed locations of AlliedSignal's wing-mounted ice sensors on an Air Canada CL-65 are optimally positioned;
- To evaluate the second generation of the NCAR snowmaking system;
- To evaluate the capabilities of ice detection camera systems;
- To examine the feasibility of and procedures for performing wing inspections with a remote ice detection camera system at the entrance to the departure runway (end-of-runway);
- To reassemble and prepare the JetStar aircraft wing for mounting, to modify it to obtain cold-soak capabilities, and to conduct fluid failure tests in natural precipitation using the wing;
- To extend hot water deicing tests to aircraft in natural outdoor precipitation conditions, and to correlate outdoor data with 1998-99 laboratory results;
- To examine safety issues and concerns of forced air deicing systems; and
- To evaluate snow weather data from previous winters to establish a range of snow precipitation suitable for the evaluation of holdover time limits.

The research activities of the program conducted on behalf of Transport Canada during the 1999-2000 winter season are documented in nine reports. The titles of these reports are as follows:

- TP 13659E Aircraft Ground De/Anti-icing Fluid Holdover Time and Endurance Time Testing Program for the 1999-2000 Winter;
- TP 13660E Aircraft Full-Scale Test Program for the 1999-2000 Winter: Evaluation of the Positioning of Surface-Mounted Ice Detection Sensors on the Bombardier CL-65 Aircraft;
- TP 13661E A Second-Generation Snowmaking System: Prototype Testing;
- TP 13662E Ice Detection Sensor Capabilities for End-of-Runway Wing Checks: Phase 2 Evaluation;



- TP 13663E Hot Water Deicing of Aircraft: Phase 2;
- TP 13664E Safety Issues and Concerns of Forced Air Deicing Systems;
- TP 13665E Snow Weather Data Evaluation (1995-2000);
- TP 13666E Contaminated Aircraft Simulated Takeoff Tests for the 1999-2000 Winter: Preparation and Procedures; and
- TP 13667E Preparation of JetStar Wing for Use in Deicing Research.

This report, TP 13660E, has the following objective:

- To evaluate whether the proposed locations of AlliedSignal's wing-mounted ice sensors on Bombardier CL-65 are optimally positioned.

This objective was met by conducting aircraft tests during snow at Dorval Airport.

## **ACKNOWLEDGEMENTS**

This research has been funded by the Civil Aviation Group, Transport Canada, with support from the US Federal Aviation Administration. This program could not have been accomplished without the participation of many organizations. APS would therefore like to thank the Transportation Development Centre of Transport Canada, the Federal Aviation Administration, National Research Council Canada, Atmospheric Environment Services Canada, and several fluid manufacturers. Special thanks are extended to US Airways Inc., Air Canada, the National Centre for Atmospheric Research, AéroMag 2000, Aéroports de Montreal, G. Vestergaard A/S, Hudson General Aviation Services Inc., Union Carbide, Cryotech, BFGoodrich, Cox and Company Inc., Fortier Transfert Ltée, and MTN Snow Equipment Inc. for provision of personnel and facilities and for their co-operation with the test program. APS would also like to acknowledge the dedication of the research team, whose performance was crucial to the acquisition of hard data. The authors gratefully acknowledge the contribution of the APS Aviation data collection and research team: Nicolas Blais, Jeff Mayhew, Michael Chaput, and Tara Newman. Special thanks are extended to NCAR personnel, and to Frank Eyre and Barry Myers of the Transportation Development Centre for their participation, contribution, and guidance in the preparation of this document.



1. Transport Canada Publication No. <b>TP 13660E</b>		2. Project No. <b>9789</b>		3. Recipient's Catalogue No.		
4. Title and Subtitle <b>Aircraft Full-Scale Test Program for the 1999-2000 Winter: Evaluation of the Positioning of Surface-Mounted Ice Detection Sensors on the Bombardier CL-65 Aircraft</b>				5. Publication Date <b>December 2000</b>		
				6. Performing Organization Document No. <b>CM1589.001</b>		
7. Author(s) <b>Marc Hunt and Medhat Henna</b>				8. Transport Canada File No. <b>ZCD2450-23-14 (DC-182)</b>		
9. Performing Organization Name and Address <b>APS Aviation Inc. 1100 René Lévesque Blvd. West Suite 1340 Montreal, Quebec Canada H3B 4N4</b>				10. PWGSC File No. <b>XSD-9-01714</b>		
				11. PWGSC or Transport Canada Contract No. <b>T8200-9-9563/001/XSD</b>		
12. Sponsoring Agency Name and Address <b>Transportation Development Centre (TDC) 800 René Lévesque Blvd. West Suite 600 Montreal, Quebec H3B 1X9</b>				13. Type of Publication and Period Covered <b>Final</b>		
				14. Project Officer <b>B. Myers</b>		
15. Supplementary Notes (Funding programs, titles of related publications, etc.) <p>Research reports produced on behalf of Transport Canada for testing during previous winters are available from the Transportation Development Centre (TDC). Nine reports (including this one) were produced as part of this winter's research program. Their subject matter is outlined in the preface.</p>						
16. Abstract <p>This report documents a third year of full-scale aircraft testing to establish anti-icing fluid failure patterns on a variety of wings.</p> <p>A primary objective of this project was to evaluate whether the proposed mounting locations of AlliedSignal's wing-mounted ice sensors on an Air Canada, Bombardier CL-65 Regional Jet are optimally positioned. A single test session was conducted during the night of January 12, 2000. A CL-65 RJ was made available at Dorval International Airport between the hours of 23:00 and 04:00. A total of eight individual fluid runs were performed during the test session.</p> <p>The visual fluid failure times were generally shorter than the sensor location fluid failure times. The sensor locations were chosen to accommodate the structural design of the aircraft wing. The locations were near the centre (main structure) of the wing toward the root and the tip. De/anti-icing fluids pool in the centre of the wing and offer more protection than areas near the leading edge and the control surfaces.</p> <p>Test plate visual fluid failure generally occurred before complete wing failure.</p> <p>In a test of Type IV fluid, at the time when the test stopped, over 20 percent of the wing surface was covered with contamination yet fluid failures were not detected on the test plates.</p> <p>Fluid on the raised sensor heads failed more rapidly in the trials with thinner, less viscous fluids. However, the neat, more viscous Type IV fluids accumulated near the raised sensor and provided additional protection from precipitation contamination and therefore lasted longer.</p>						
17. Key Words <b>Ice detection, sensors, aircraft wing, anti-icing fluid failure</b>				18. Distribution Statement <b>Limited number of copies available from the Transportation Development Centre</b>		
19. Security Classification (of this publication) <b>Unclassified</b>		20. Security Classification (of this page) <b>Unclassified</b>		21. Declassification (date) <b>—</b>	22. No. of Pages <b>xiv, 38, apps</b>	23. Price <b>Shipping/ Handling</b>



1. N° de la publication de Transports Canada <b>TP 13660E</b>		2. N° de l'étude <b>9789</b>		3. N° de catalogue du destinataire		
4. Titre et sous-titre <b>Aircraft Full-Scale Test Program for the 1999-2000 Winter: Evaluation of the Positioning of Surface-Mounted Ice Detection Sensors on the Bombardier CL-65 Aircraft</b>				5. Date de la publication <b>Décembre 2000</b>		
				6. N° de document de l'organisme exécutant <b>CM1589.001</b>		
7. Auteur(s) <b>Marc Hunt et Medhat Henna</b>				8. N° de dossier - Transports Canada <b>ZCD2450-23-14 (DC-182)</b>		
9. Nom et adresse de l'organisme exécutant <b>APS Aviation Inc. 1100, boul. René-Lévesque Ouest Bureau 1340 Montréal, Québec Canada H3B 4N4</b>				10. N° de dossier - TPSGC <b>XSD-9-01714</b>		
				11. N° de contrat - TPSGC ou Transports Canada <b>T8200-9-9563/001/XSD</b>		
12. Nom et adresse de l'organisme parrain <b>Centre de développement des transports (CDT) 800, boul. René-Lévesque Ouest Bureau 600 Montréal (Québec) H3B 1X9</b>				13. Genre de publication et période visée <b>Final</b>		
				14. Agent de projet <b>B. Myers</b>		
15. Remarques additionnelles (programmes de financement, titres de publications connexes, etc.) <p>Les rapports de recherche produits au nom de Transports Canada sur les essais réalisés au cours des hivers antérieurs peuvent être obtenus auprès du Centre de développement des transports (CDT). Le programme de la saison hivernale a donné lieu à neuf rapports (dont celui-ci). On trouvera dans la préface l'objet de ces rapports.</p>						
16. Résumé <p>Ce rapport rend compte d'une troisième année d'essais sur des voilures d'aéronefs, lesquels visent à mieux comprendre la perte d'efficacité des liquides antigivre sur diverses voilures.</p> <p>Un des objectifs premiers de ce projet était de déterminer si les emplacements proposés pour l'implantation de capteurs de givre de AlliedSignal dans une aile de Bombardier Regional Jet CL-65 d'Air Canada sont optimaux. Les essais ont été réalisés en une seule séance, de 23 h à 4 h pendant la nuit du 12 janvier 2000, à l'Aéroport international de Montréal – Dorval. Huit applications de liquides ont été faites sur la voilure du CL-65 RJ mis à la disposition des chercheurs.</p> <p>De façon générale, les capteurs indiquaient la perte d'efficacité des liquides après que celle-ci eut été constatée visuellement. Les capteurs avaient été implantés à des endroits compatibles avec la structure de l'aile, c'est-à-dire à proximité du centre (de la structure principale) de l'aile, dans les régions de l'emplanture et du bout. Or, les liquides de dégivrage/antigivre s'accumulent au centre de l'aile et ces zones bénéficient ainsi d'une meilleure protection que les zones à proximité du bord d'attaque et des gouvernes.</p> <p>La perte d'efficacité visuelle sur les plaques d'essai précédait généralement la perte d'efficacité sur l'aile complète.</p> <p>Lors d'un essai avec un liquide de type IV, au moment où l'essai s'est terminé, plus de 20 p. 100 de la surface de l'aile était couverte de contamination, sans qu'aucune perte d'efficacité du liquide ait été détectée sur les plaques d'essai.</p> <p>Les liquides relativement clairs, à faible viscosité, demeuraient efficaces moins longtemps sur les capteurs en saillie qu'ailleurs sur l'aile. Mais comme les liquides de type IV non dilués, à plus grande viscosité, s'accumulaient près de ces capteurs, ils les protégeaient davantage contre la contamination due aux précipitations et retardaient donc la détection de la perte d'efficacité.</p>						
17. Mots clés <b>Détection de givre, capteurs, aile d'avion, perte d'efficacité des liquides antigivre</b>				18. Diffusion <b>Le Centre de développement des transports dispose d'un nombre limité d'exemplaires.</b>		
19. Classification de sécurité (de cette publication) <b>Non classifiée</b>		20. Classification de sécurité (de cette page) <b>Non classifiée</b>		21. Déclassification (date) <b>—</b>	22. Nombre de pages <b>xiv, 38, ann.</b>	23. Prix <b>Port et manutention</b>

## EXECUTIVE SUMMARY

At the request of the Transportation Development Centre of Transport Canada, APS Aviation Inc. has undertaken a research program to further advance aircraft ground de/anti-icing technology.

This report documents a third year of full-scale aircraft testing to establish anti-icing fluid failure patterns on a variety of wings. The first year involved the Boeing 737 and Fokker 100 aircraft tested in snow conditions (TP 13130E – *Aircraft Full-Scale Test Program for the 1996/97 Winter*); in the second year, Air Canada, Bombardier CL-65 Regional Jet (CL-65 RJ) aircraft were studied to establish failure patterns for frost (TP 13485E – *Aircraft Full-Scale Test Program for the 1998/99 Winter*). This third year of testing was done in snow conditions, again on CL-65 RJ aircraft. A further objective of this project was to evaluate whether the proposed mounting locations of AlliedSignal's wing-mounted ice sensors on a CL-65 RJ are optimally positioned.

### Description and Processing of Data

A single test session was conducted during the night of January 12, 2000. For this purpose, a CL-65 RJ was made available at Dorval International Airport between the hours of 23:00 and 04:00.

A total of eight individual fluid runs were performed on the CL-65 aircraft during the test session. Seven Type I tests and one Type IV test were performed during the full-scale session.

## RESULTS AND CONCLUSIONS

In general, the leading and trailing edges fail first, depending on aircraft type and wing design, followed by the mid-wing sections. For aircraft with hard wing design, such as the Fokker 100, initial failures occur primarily on the trailing edge at the highest points of the ailerons and spoilers. The same pattern of fluid failure was observed to occur on the CL-65 RJ, which also had a hard wing leading edge design. This was particularly true for Type I fluid tests. For the single Type IV test, a small amount of contamination was observed early in the test on the nose of the leading edge; however, the single Type IV test session was forced to end early and proved insufficient to fully document the fluid failure pattern for this fluid.

### Sensor Location Failures

The wing visual fluid failure times were generally shorter than the sensor location visual fluid failure times. The sensor locations were chosen to

accommodate the structural design of the aircraft wing. The locations are near the centre (main structure) of the wing toward the root and the tip. De/anti-icing fluids pool in the centre of the wing and offer more protection than areas near the leading edge and the control surfaces.

### **Plate Failure Times**

Test plate failure times did not coincide with the same wing failure levels during each test. The plates generally failed before complete wing failure had occurred.

### **Type IV Failure Patterns**

One Type IV test was conducted during the full-scale test session. At the time the test was stopped because the aircraft had to be returned for a flight, over 20 percent of the wing surface was covered with contamination. Fluid failures were not detected on the test plates when the test was stopped.

### **Additional Trials with Raised Sensors**

Because the full-scale trials demonstrated that the fluid at the sensor locations failed after other areas of the wing, additional trials were conducted on plates with raised sensors. The raised sensor heads failed more rapidly in the trials with thinner, less viscous fluids. The neat Type IV fluids did not behave in the same manner. These viscous fluids accumulated near the raised sensor and provided additional protection from precipitation contamination.

## **RECOMMENDATIONS**

The lack of suitable weather and aircraft availability demonstrates the need for a full-scale deicing test site, centred around a wing test bed.

## SOMMAIRE

À la demande du Centre de développement des transports de Transports Canada, APS Aviation Inc. a entrepris un programme de recherche afin de pousser plus avant le développement de la technologie du dégivrage et de la protection antigivre des avions au sol.

Ce rapport rend compte d'une troisième année d'essais sur des voilures d'aéronefs, lesquels visent à mieux comprendre la perte d'efficacité des liquides antigivre sur diverses voilures. La première année, les essais ont porté sur un Boeing 737 et un Fokker 100, dans des conditions de précipitations neigeuses (TP 13130E – *Aircraft Full-Scale Test Program for the 1996/97 Winter*); la deuxième année, la perte d'efficacité des liquides en présence de givre a été étudiée à l'aide d'un Bombardier Regional Jet CL-65 (RJ CL-65) d'Air Canada (TP 13485E – *Aircraft Full-Scale Test Program for the 1998/99 Winter*). La troisième année d'essais a eu lieu dans des conditions de précipitation neigeuses, encore une fois avec un avion CL-65 RJ. Ce projet avait pour objectif particulier de déterminer si les emplacements proposés pour l'implantation de capteurs de givre de AlliedSignal dans une aile de Bombardier Regional Jet CL-65 d'Air Canada sont optimaux.

### Description des essais

Une seule séance d'essai a eu lieu de 23 h à 4 h, pendant la nuit du 12 janvier 2000, sur un avion CL-65 RJ mis à la disposition des chercheurs à l'Aéroport international de Montréal – Dorval.

Au total, huit essais d'application de liquides ont été réalisés sur le CL-65, soit sept essais du liquide de type I et un essai du liquide de type IV.

### RÉSULTATS ET CONCLUSIONS

De façon générale, la perte d'efficacité apparaît d'abord sur le bord d'attaque et le bord de fuite de l'aile, selon le type d'avion et la conception de l'aile, puis elle s'étend à l'aile médiane. Dans le cas des avions à bec de bord d'attaque fixe, comme le Fokker 100, les premiers signes de perte d'efficacité se manifestent sur le bord de fuite, aux points hauts des ailerons et des déporteurs. La perte d'efficacité s'est manifestée de manière semblable sur le CL-65 RJ, dont le bec du bord d'attaque est aussi fixe. Cela était particulièrement vrai lors des essais de liquides de type I. Lors de l'unique essai d'un liquide de type IV, une petite quantité de contamination a été constatée tôt au cours de l'essai sur la partie avant du bord d'attaque, mais cet essai a été interrompu précocement et les données recueillies ne permettent pas de tirer des conclusions claires sur la perte d'efficacité de ce liquide.



## **Perte d'efficacité aux emplacements des détecteurs**

De façon générale, les capteurs indiquaient la perte d'efficacité des liquides après que celle-ci eut été constatée visuellement. Les capteurs avaient été implantés à des endroits compatibles avec la structure de l'aile, c'est-à-dire à proximité du centre (de la structure principale) de l'aile, dans les régions de l'emplanture et du bout. Or, les liquides de dégivrage/antigivre s'accumulent au centre de l'aile et ces zones bénéficient ainsi d'une meilleure protection que les zones à proximité du bord d'attaque et les gouvernes.

## **Durées d'efficacité sur les plaques d'essai**

À aucun des essais, la durée d'efficacité du liquide sur les plaques d'essai ne coïncidait avec la durée d'efficacité sur la voilure d'aéronef. La perte d'efficacité apparaissait généralement sur les plaques d'essai plus tôt que sur la voilure.

## **Perte d'efficacité du liquide de type IV**

Un seul essai d'application de liquide de type IV a eu lieu en grandeur réelle. Au moment où l'essai a dû être interrompu, parce que l'avion devait effectuer un vol, plus de 20 p. 100 de la surface de l'aile était couverte de contamination. Aucun signe de perte d'efficacité du liquide n'avait alors été détecté sur les plaques d'essai.

## **Essais supplémentaires de capteurs en saillie**

Comme les essais en grandeur réelle ont démontré que le liquide demeurait efficace plus longtemps aux emplacements des détecteurs qu'ailleurs sur l'aile, d'autres essais ont été réalisés sur des plaques dans lesquelles avaient été implantés des capteurs en saillie. Ces capteurs annonçaient une perte d'efficacité plus tôt lorsque des liquides relativement clairs, à faible viscosité, étaient utilisés. Les liquides de type IV non dilués se comportaient autrement. En effet, plus visqueux, ils s'accumulaient à proximité du capteur et lui assuraient ainsi une protection supplémentaire contre la contamination due aux précipitations.

## **RECOMMANDATIONS**

La rareté des conditions météorologiques propices et la difficulté d'avoir accès à des avions pour des essais met en relief la nécessité de disposer d'une installation d'essai en vraie grandeur, centrée sur une aile d'essai, pour la recherche sur le dégivrage.

**CONTENTS**

	<b>Page</b>
<b>1. INTRODUCTION .....</b>	<b>1</b>
1.1 Objectives .....	1
<b>2. METHODOLOGY .....</b>	<b>3</b>
2.1 Test Sites.....	3
2.2 Test Plan.....	4
2.3 Equipment .....	6
2.4 Description of Test Procedures .....	10
2.5 Data Forms.....	11
2.6 Fluids .....	12
2.7 Personnel .....	12
<b>3. DESCRIPTION AND PROCESSING OF DATA .....</b>	<b>19</b>
3.1 Overview of Test Sessions .....	19
<b>4. ANALYSIS AND OBSERVATIONS .....</b>	<b>27</b>
4.1 Fluid Failure at Proposed Sensor Locations .....	27
4.2 Standard Plate Failure Times .....	29
4.3 Type IV Failure Patterns .....	31
4.4 Raised C/FIMS Trials .....	31
<b>5. CONCLUSIONS .....</b>	<b>35</b>
5.1 Sensor Location Failures .....	35
5.2 Plate Failure Times .....	35
5.3 Type IV Failure Patterns .....	35
5.4 Raised C/FIMS Trials .....	35
<b>6. RECOMMENDATIONS .....</b>	<b>37</b>

**LIST OF APPENDICES**

- A** Work Statement – Aircraft and Fluid Holdover Time Tests for 1999-2000 Winter
- B** Experimental Program for Full-Scale Aircraft Fluid Failure Testing
- C** Wing Failure Diagrams – January 26, 2000
- D** Detailed Precipitation Rates – January 26, 2000
- E** Fluid Freeze Point Temperature Profiles
- F** Plate and Wing Failure Times

## LIST OF FIGURES

	<b>Page</b>
2.1 Deicing Pad Location at Dorval Airport .....	5
2.2 Flat Plate Test Set-Up .....	7
2.3 Flat Plate Test Set-Up and Fluid Application .....	8
2.4 Position of Equipment and Personnel .....	9
3.1 Proposed C/FIMS Sensor Locations on RJ Wing .....	20
3.2 De/Anti-Icing Form for Aircraft Wing .....	24
3.3 Localized Form for Aircraft Wing .....	25
3.4 Precipitation Rates – January 26, 2000 .....	26
4.1 Fluid Freeze Point Temperature Profile .....	28
4.2 Plate and Wing Failure Times for Run 1 .....	30

## LIST OF TABLES

3.1 Listing of Full-Scale Tests Conducted in 2000 .....	21
3.2 Full-Scale C/FIMS Location Data Analysis .....	23
4.1 Raised Sensor Trials .....	32

## LIST OF PHOTOS

2.1 Precipitation Rate Measuring Equipment .....	15
2.2 Field Lab for Full-Scale Tests.....	15
2.3 Set-Up of Full-Scale Aircraft Trials .....	17

## **GLOSSARY**

A/C	Aircraft
ADF	Aircraft Deicing Fluid
APS	APS Aviation Inc.
BFG	BFGoodrich
C/FIMS	Contaminated/Fluid Integrity Measurement System
CL-65 RJ	Air Canada, Bombardier CL-65 Regional Jet
cP	Centipoise
HOT	Holdover Time
OAT	Outside Air Temperature
READAC	Remote Environmental Automatic Data Acquisition Concept
RJ	Regional Jet
TDC	Transportation Development Centre
UCAR	Union Carbide

***This page intentionally left blank.***

## 1. INTRODUCTION

At the request of the Transportation Development Centre (TDC), APS Aviation Inc. (APS) has undertaken a research program to further advance aircraft ground de/anti-icing technology.

Aircraft ground de/anti-icing has been the subject of concentrated industry attention over the past decade as the result of a number of fatal aircraft accidents. Recent attention has been placed on the enhancement of anti-icing fluids to provide an extended duration of protection against further contamination following initial deicing. This has led to the development of fluid holdover time (HOT) tables used by aircraft operators and accepted by regulatory authorities. New fluids continue to be developed specifically to prolong fluid holdover times without compromising airfoil aerodynamics.

This report documents a third year of full-scale aircraft testing to establish anti-icing fluid failure patterns on a variety of wings. The first year involved the Boeing 737 and Fokker 100 aircraft tested in snow conditions (TP 13130E – *Aircraft Full-Scale Test Program for the 1996/97 Winter*); in the second year, Air Canada, Bombardier CL-65 Regional Jet (CL-65 RJ) aircraft were studied to establish failure patterns for frost (TP 13485E – *Full-Scale Test Program for the 1998/99 Winter*). This third year of testing was done in snow conditions, again on CL-65 RJ aircraft. A further objective of this project was to evaluate whether the proposed mounting locations of AlliedSignal's wing-mounted ice sensors on a CL-65 are optimally positioned.

APS has conducted more than 250 full-scale aircraft tests since 1993.

### 1.1 Objectives

A primary objective of this project was to collect data to determine the most suitable locations for installation of two AlliedSignal C/FIMS ice sensors on each wing of a CL-65 RJ. Two specific locations have been proposed.

An excerpt from the detailed work statement is contained in Appendix A and the experimental program procedure is included in Appendix B.

In addition to the primary objective, several related objectives were subsequently defined:

- To compare the performance of de/anti-icing fluids on aircraft surfaces with the performance of de/anti-icing fluids on flat plates;



## **1. INTRODUCTION**

---

- To examine the pattern of failure using Type IV fluid brands not tested in the past; and
- To investigate progression of fluid failure on the CL-65 RJ aircraft when exposed to different predominant wind conditions.

## 2. METHODOLOGY

This section of the report details the complete environment and support infrastructure that surrounds testing of this nature, and includes information about test facilities, equipment, procedures, and personnel.

The methodology is based on similar work conducted in previous years,<sup>1</sup> and the same procedures may also be followed in any future tests performed.

To satisfy the objectives, the fluid applied to the flat plates for the Type I tests was as follows:

- Heated UCAR XL54 fluid was applied on two plates. The fluid was taken from the deicing truck to have a direct comparison with the fluid that was sprayed on the wing.
- Warm (20°C) UCAR ADF (10°C buffer) fluid was applied on two plates. This represents the typical application used for standard endurance time tests.

The descriptions focus on identification and evaluation of characteristics associated with fluid failure.

Failure time is defined herein as the time required for the accumulating precipitation to cause the fluid surface to be failed.

A surface is here considered to be locally "failed" if, at that location:

- There is a visible accumulation of snow on the fluid on the wing surface that is not being absorbed, or
- Ice is visible on the fluid surface.

The class of failure is usually termed "visual failure" as opposed to "failure" involving ice adhesion to a surface.

### 2.1 Test Sites

Aircraft fluid failure tests were performed on one occasion at Dorval International Airport, Montreal, during the 1999-2000 test season.

---

<sup>1</sup> J. D'Avirro, et al., *Aircraft Full-Scale Test Program for the 1996/97 Winter*, APS Aviation Inc. report for the Transportation Development Centre of Transport Canada, TP 13130E, December 1997, p. 18.

These tests were conducted at the Dorval Airport central deicing facility, operated by AéroMag 2000 (see Figure 2.1). The APS test site (where flat plate tests to determine fluid holdover times are conducted) is also indicated in Figure 2.1, as is Environment Canada's automated weather station.

## 2.2 Test Plan

A dry run and up to three one-night test sessions were originally planned for the 1999-2000 winter, using a CL-65 RJ aircraft owned by Air Canada.

Test sessions on the CL-65 RJ aircraft were scheduled to take place after normal airport operating times (between 23:00 and 06:00).

Tests were conducted in the following conditions:

- **Aircraft orientation** – Headwind, tailwind, crosswind
- **Precipitation type** – Snow
- **Fluids** – Type I, Type IV

Scheduling was based on a reasonable forecast of precipitation for the evening/overnight, provided that the airline was available to support and participate in the tests.

Forecasts were monitored daily using radio, television, and Internet sources. A forecast was obtained from the Environment Canada web site for Dorval. This forecast prompted an alert that was issued to all airline personnel related to the fluid tests. The weather system was closely monitored as the storm approached. This was done via direct one-to-one telephone communication with a trained Environment Canada professional using Environment Canada's 1-900 service.

For the test session, up to ten tests were originally planned using both Type I and Type IV fluids. Aircraft were to be positioned at a predetermined orientation prior to the start of the first test. The test plan included the reorientation of the aircraft relative to wind direction between individual tests during the course of the test session.

In practice only one night of testing was possible because of lack of suitable weather and aircraft availability.

FIGURE 2.1  
DEICING PAD LOCATION AT DORVAL AIRPORT

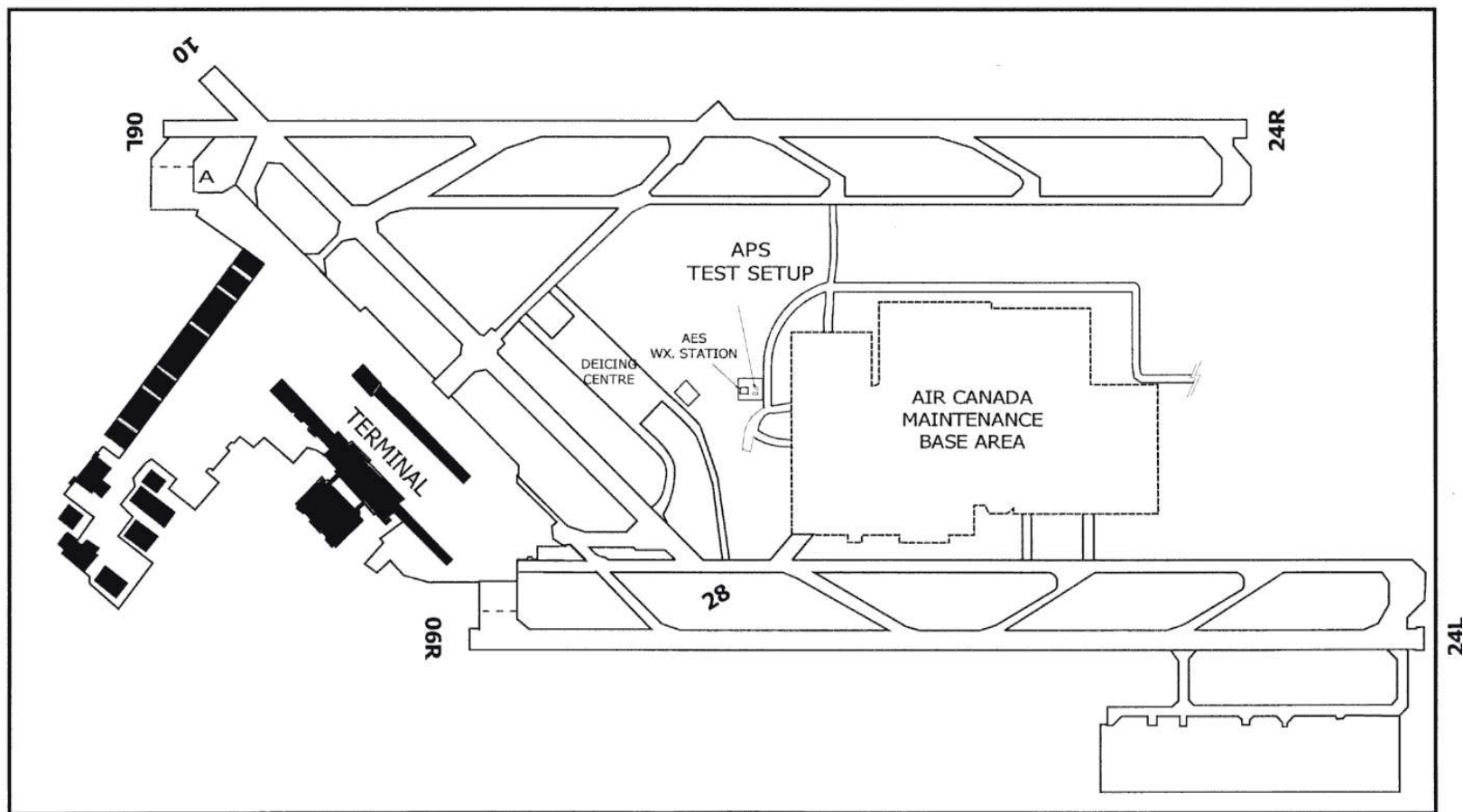

### 2.3 Equipment

One full-scale test session was performed at Dorval International Airport during the 1999-2000 winter test season. The test aircraft was provided by Air Canada (CL-65 RJ). AéroMag 2000, operators of the deicing facility at Dorval, supplied specially equipped vehicles and personnel for the application of fluids. Union Carbide provided the fluids.

Photo 2.1 shows the equipment kit used to measure precipitation rates. Two collection pans with base dimensions identical to standard flat test plates were used to capture precipitation.

An electronic balance, shielded with plexiglass to reduce wind effects, was used to weigh the precipitation pans. The rate station was positioned on a table in the cube van. The van was positioned adjacent to the test stand. Photo 2.2 shows the truck used during the full-scale tests. The space in the van was also used for debriefing the test team between tests.

Rolling staircases and several stepladders (see Photo 2.3) were positioned around each aircraft wing. Mobile mast-light units supplied wing illumination. Each unit consisted of four 1 000 W floodlights. A 6 kW diesel generator (an integral component of each unit) was also used to supply current for the lights and for other electrical requirements.

During full-scale aircraft trials, standard flat plate tests were conducted in tandem on a 10 degree inclined standard flat plate test stand. The plates were marked with the standard holdover time markings shown in Figure 2.2. Figure 2.3 shows a schematic of a test stand and fluid application procedure. Figure 2.4 provides a schematic of the positioning of major equipment and key personnel about the aircraft.

A list of the mobile equipment used by each of the test team members is shown in Attachment VII of Appendix B. The mobile equipment required for the truck is listed in Attachment VIII of Appendix B.

Sampling kits consisted of spatulas and a small collection of storage containers. These were distributed to personnel responsible for the collection of fluid samples at failure locations on the wing. The freeze points of the fluid samples were to be measured immediately with a handheld Brix-scale refractometer.

Two video cameras, a digital video camera, a 35 mm still camera, and a digital still camera were used to record fluid failures on wings and plates.

FIGURE 2.2  
FLAT PLATE TEST SET-UP

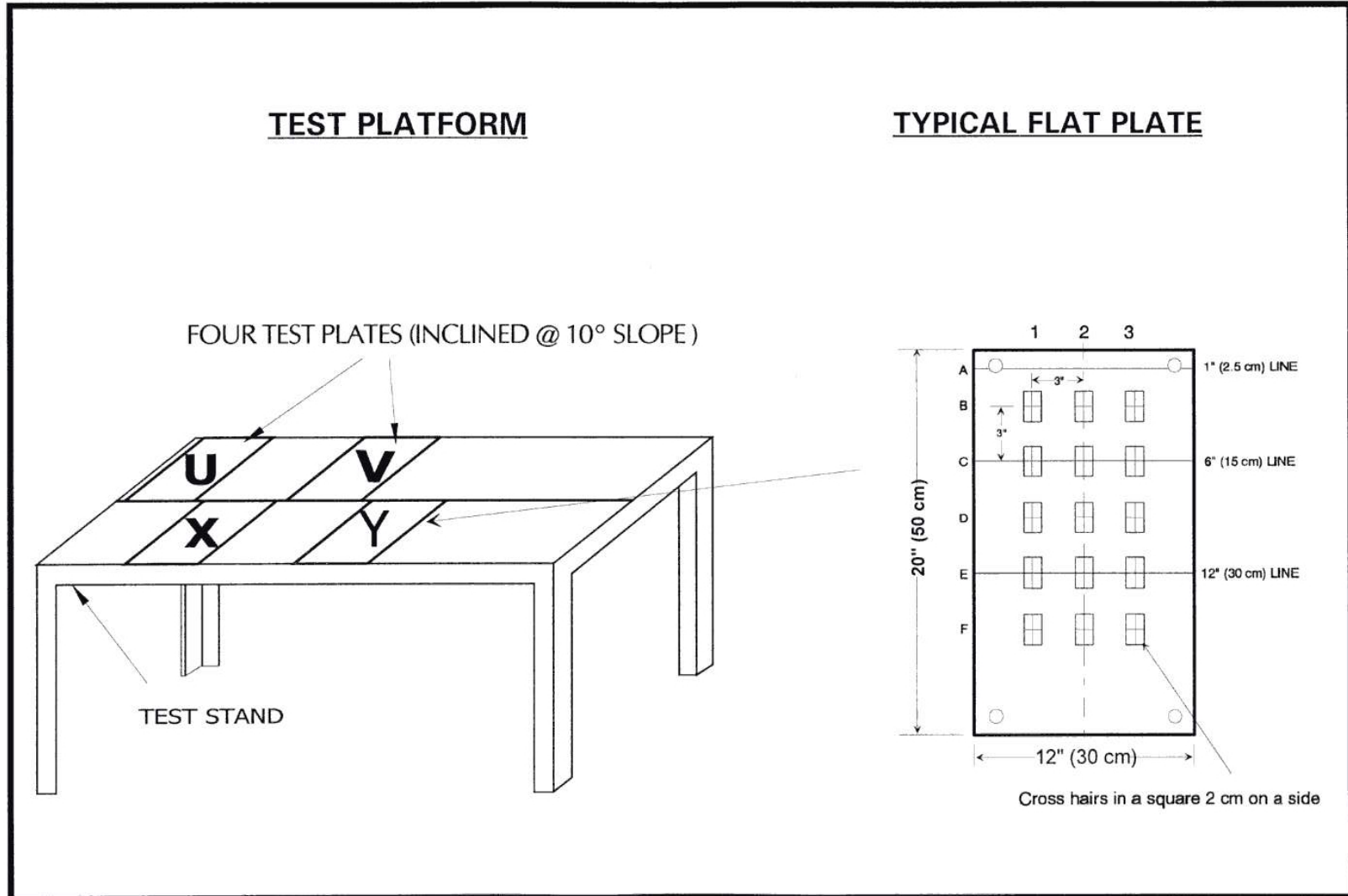



**FIGURE 2.3  
FLAT PLATE TEST SET-UP AND FLUID APPLICATION**

**TYPE I FLUID APPLICATION**

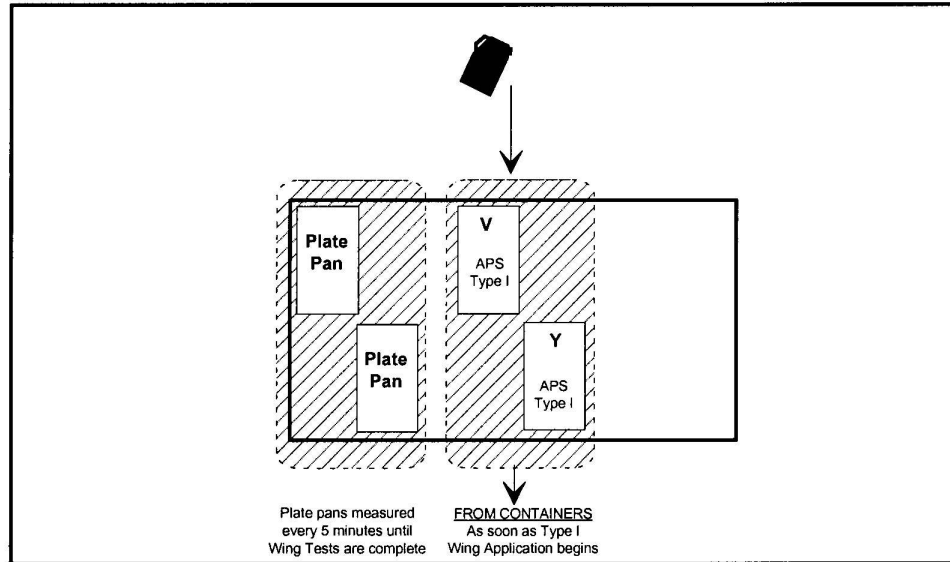

Note: Application of Fluid was on 4 plates, 2 with heated XL54 from the deicing truck and 2 with 10°C buffer ADF fluid at 20°C.

**TYPE IV FLUID APPLICATION**

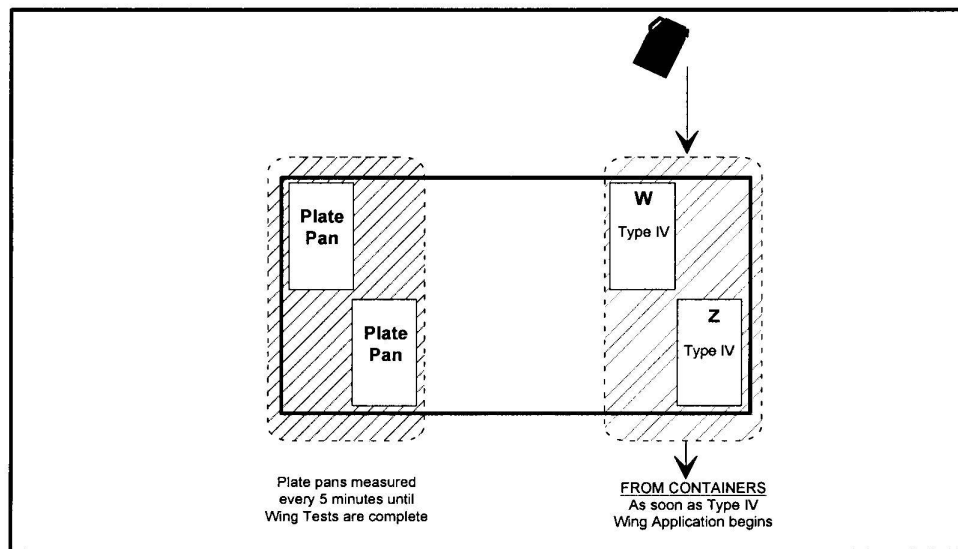
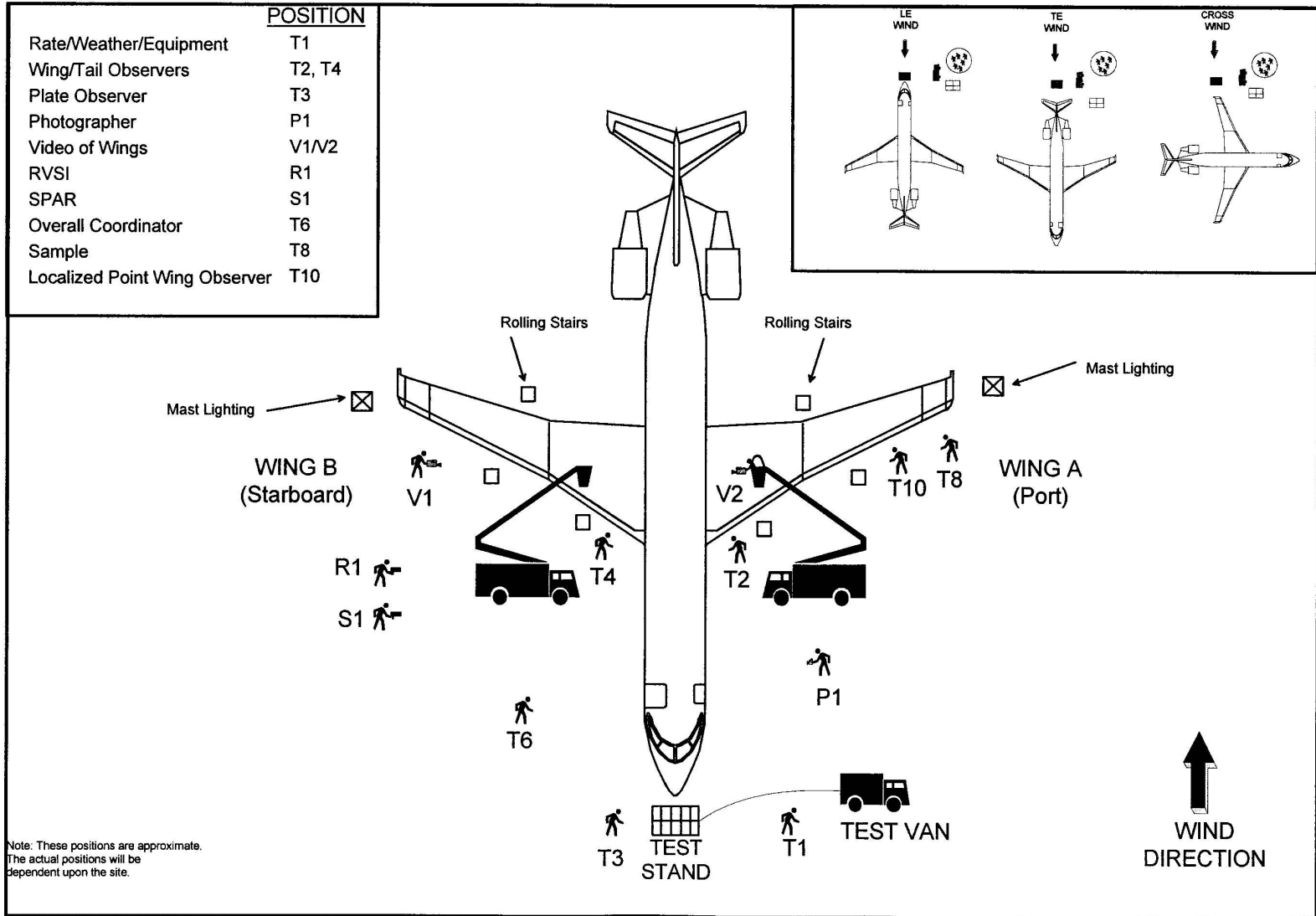

FIGURE 2.4  
**POSITION OF EQUIPMENT AND PERSONNEL**



Meteorological data such as temperature, wind speed, and wind direction were provided by the Remote Environmental Automatic Data Acquisition Concept (READAC), which is located a very short distance from the central deicing facility at Dorval International Airport.

Wing skin temperatures were recorded using handheld temperature probes. A complete list of test equipment used for the Dorval aircraft full-scale test program is given in Attachment I of Appendix B.

## **2.4 Description of Test Procedures**

The Experimental Program for Full-Scale Fluid Failure Testing is provided in Appendix B. This APS document describes the detailed procedures employed during the course of the full-scale test session.

APS personnel monitored weather forecasts on an ongoing basis throughout the test season to anticipate conditions that would require aircraft deicing. If these conditions were forecast, the test team was alerted 48 hours prior to the predicted event. Contacting airlines to secure a test aircraft preceded confirmation of the precipitation event. Arrangements were then made with AéroMag for use of the deicing facility, spray equipment and personnel. Test equipment, including trucks, mast lights, and generators, was rented. Transport Canada and other companies working in conjunction with APS were then notified.

Fluids for full-scale flat plate tests were transported in pre-marked red polyethylene fuel containers. The Type I and Type IV fluids were collected from the deicing truck prior to their application on the aircraft wings. The fluids were poured directly from these containers onto flat plates. The standard flat plate one-step fluid application procedure used for HOT tests was used.

The APS fluid sampling team collected fluid samples on an ongoing basis during tests at the location of first wing failure and at various points of failure on the wing thereafter (as indicated by the wing observer). The fluid sample concentrations were measured directly using a handheld Brix-scale refractometer. Both the fluid sample time and the location from which the sample was taken were recorded immediately. The sampling procedure is described in Attachment VI of Appendix B.

Several minor improvements were made in recent years to the plate pan precipitation rate data collection procedure. The start and end times of the rate collection period were to be recorded in hours, minutes, and seconds rather than rounded off to the nearest whole minute. Also, a few seconds

were added to or subtracted from the rate collection start and end times for time delays created by entering and exiting the truck. Finally, any precipitation that accumulated on the lips, sides, and bottoms of the plate pans was to be removed prior to weighing the pans.

In the past, the time and precise location of first failure were occasionally missed by the wing observer. This is because of the rapid onset and propagation of failures, especially in the case of Type I fluids. In certain tests, failures progressed so rapidly that they reached the 25 percent level by the time the first failure contour was recorded. Procedures were altered to emphasize the requirement to identify the precise location of first wing failure. In tests where rapid failure progression is to be expected, additional observers from the test team would be assigned to assist the wing observer in failure detection.

BFG Aerospace (formerly RVSI) and/or Spar/Cox did not provide ice detection sensors. The procedure for use of the BFG ice detection sensor unit is provided in Attachment X of Appendix B. At the time of initial fluid application, the instrument operator would be instructed to scan and capture an image of the tail identification number of the aircraft to mark the start of the holdover time period. The grid structure, as illustrated in Figure B-3 of Appendix B, was used to determine the order of images taken by the operator. An entire series of images covering the wing was to be taken every 15 minutes. At the end of the test, the instrument operator would be instructed to scan and capture the tail identification number again, to signify the end of the record for that test.

## **2.5 Data Forms**

Several different data forms were produced for full-scale testing in 1999-2000 and are given in Appendix B.

The *General Form – Every Test* (see Appendix B, Figure B-6a) was completed by the plate/wing co-ordinator and was used to record information such as the type, temperature and quantity of fluid sprayed, as well as the start and end times of the fluid applications.

Another *General Form – Once Per Session* (see Appendix B, Figure B-6b) was completed by the overall co-ordinator and was used to record information relating to the aircraft, fluids, and initial aircraft skin temperatures.

The *Aircraft Wing Form* (see Appendix B, Figure B-7a,b) shows the form used for fluid failure tests on the CL-65 RJ. A form was created for each of the port and starboard wings. Wing observers were assigned to identify fluid failures and draw failure contours on the wing diagrams.

The *Localized Aircraft Wing Form* (see Appendix B, Figure B-8) shows the form used for fluid failure tests at sensor head locations on the CL-65 RJ. A form was created for each of the port and starboard wings. Wing observers were assigned to identify fluid failures and draw failure contours on specific parts of the wing diagrams.

The *Fluid Thickness on Aircraft Form* (see Appendix B, Figure B-9) shows the form to be filled out by the individuals assigned to perform thickness measurements during test events when snow or freezing precipitation had ceased, or during dry runs. The *Fluid Thickness on Flat Plates Form* (see Appendix B, Figure B-10) was to be used to record fluid thickness measurements on flat plates during full-scale aircraft tests.

The *Aircraft Tail Form* (see Appendix B, Figure B-11a,b) was the form used for fluid failure tests on the tail of the CL-65 RJ. A form was created for the right and left sides of the tail. Wing observers were assigned to identify fluid failures and draw failure contours on specific parts of the wing diagrams.

The *End Condition Data Form* (see Appendix B, Table B-1) was completed by the end condition tester. This form was used to record information related to fluid failure times on the flat plates. The *Meteo/Plate Pan Data Form* (see Appendix B, Table B-2) was completed by the meteo/equipment tester and was to be used to record information on weather conditions and rates of precipitation.

## 2.6 Fluids

The Type I and Type IV fluids required for full-scale testing were provided by Union Carbide. Union Carbide Type I ADF was applied in standard concentration (XL54), and Type IV Ultra+ was applied in its neat concentration. The fluid was applied to the wing by AéroMag 2000. The viscosity of the Type IV Ultra + fluid was measured to be 41 500 cP, using the same method specified in the HOT tables.

## 2.7 Personnel

Personnel requirements for full-scale aircraft tests are considerable. Figure 2.4 provides a schematic description of the general test set-up, as well as the standby location of each member of the full-scale test team. All personnel were involved in the set-up and tear-down of equipment prior to

and following tests. The primary roles and responsibilities of each personnel member are listed below:

- **Rate/Weather/Equipment (T1):** Responsible for monitoring meteorological equipment and for recording all weather and precipitation rate data.
- **Wing Observers (T2, T4):** Responsible for drawing failure contours as they occur on wing surfaces.
- **End Condition Tester (T3):** Responsible for the execution of flat plate holdover time tests during full-scale aircraft tests.
- **Wing/Plate Co-ordinator (T5):** Responsible for ensuring consistency between wing and plate failure calls.
- **Photographer (P1):** Responsible for taking photographs of important events during each test.
- **Video Recorders (V1, V2):** Responsible for taking video recordings of aircraft wings, paying particular attention to fluid contamination and failure initiation and progression.
- **BFG Aerospace and Spar/Cox (R1, S1):** Responsible for taking sensor images of fluids undergoing failure on aircraft wings.
- **Overall Co-ordinator (T6):** Responsible for co-ordinating all aspects of the full-scale tests. The overall co-ordinator is also responsible for safety awareness training (based on guidelines that appear in Attachment V of Appendix B) and ensuring that safety measures are being respected during the course of full-scale testing.
- **Sampler (T8):** Responsible for the collection of fluid samples at selected points of failure on the wings.
- **Localized Point Wing Observer (T10):** Responsible for drawing failure contours as they occur on the sensor head locations of the wing surfaces.
- **Vertical Fin Observer (T11):** Responsible for drawing failure contours as they occur on the aircraft vertical fin surfaces.

A full description of test personnel responsibilities, individual duties, and positions is given in Attachment II of Appendix B.

Airline ground support personnel were to be made available to tow aircraft to and from the deicing facility, and to orient the aircraft between tests.

Deicing crews and fluid application equipment were provided by AéroMag 2000.

Photo 2.1  
Precipitation Rate Measurement Equipment

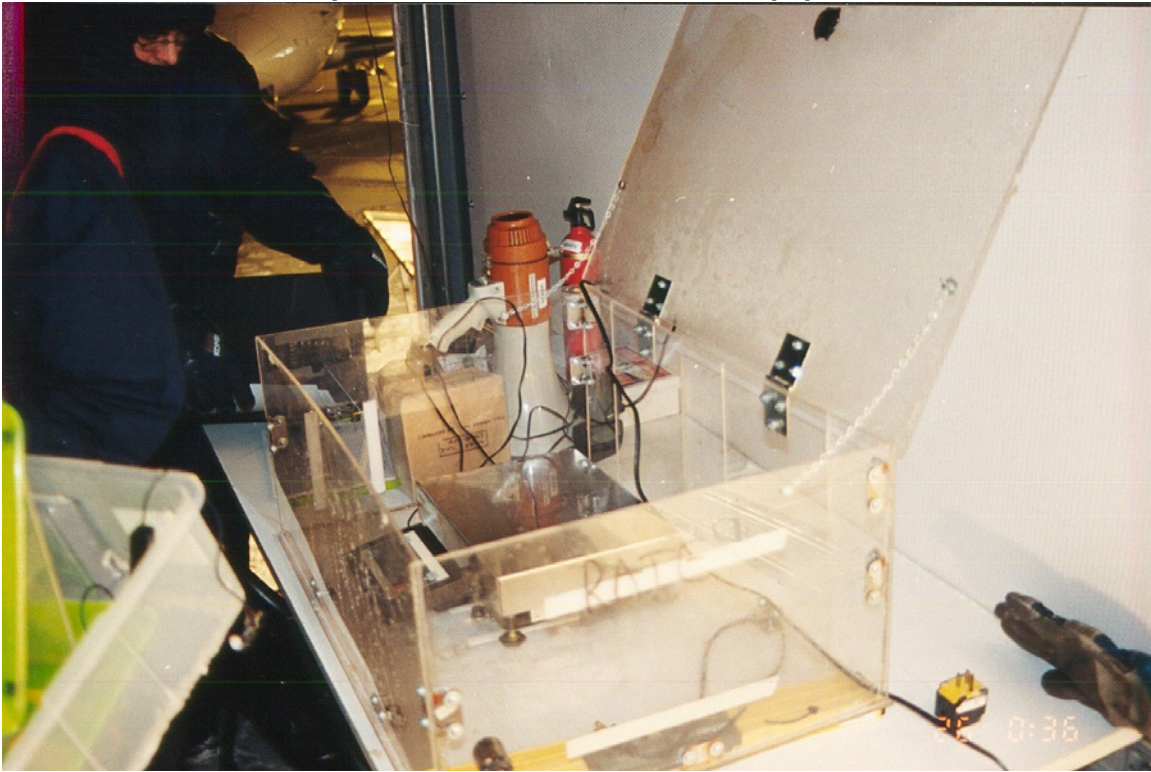

Photo 2.2  
Field Lab for Full-Scale Tests





Photo 2.3  
Set-Up of Full-Scale Aircraft Trials



### 3. DESCRIPTION AND PROCESSING OF DATA

#### 3.1 Overview of Test Sessions

A single test session was conducted during the night of January 12, 2000. For this purpose, a CL-65 RJ was made available at Dorval International Airport between the hours of 23:00 and 04:00.

A total of eight individual fluid runs were performed on the RJ aircraft during the test session. The focus during those trials was to document Type I fluid failure patterns on the wings and on the potential C/FIMS sensor locations shown in Figure 3.1. Seven Type I tests and one Type IV test were performed during the full-scale session. The Type IV test was not completed due to time constraints.

A matrix of all the tests performed is included in Table 3.1. This table indicates:

- fluids tested;
- quantity of fluid applied to the wing;
- approximate precipitation rate;
- wind direction;
- test start and end times;
- failure time for three wing failure levels; and
- test plate failure times.

The terms used in this report and in Table 3.1 are defined as follows:

- Wing first failure time: The first occurrence of failed fluid on the wing.
- Wing 10% failure time: Time when there is failed fluid over 10 percent of the wing area.
- Wing complete failure time: Time when there is failed fluid over the entire wing.
- Failure time of ADF-warm: Time when 33 percent of the fluid on the standard test plate is failed. These tests are representative of the standard holdover time tests, which are conducted using 10°C buffer fluid applied at 20°C.
- Failure time of XL54-heated: Time when 33 percent of the fluid on the standard test plate is failed. These tests are representative of the normal deicing operation. They were carried out using heated (typically to 80°C), full-strength fluid from the deicing truck.

The plate fluid failure times and the rate for both the plates and the aircraft wings were taken from the test stand data.

FIGURE 3.1  
PROPOSED C/FIMS SENSOR LOCATIONS ON RJ WING

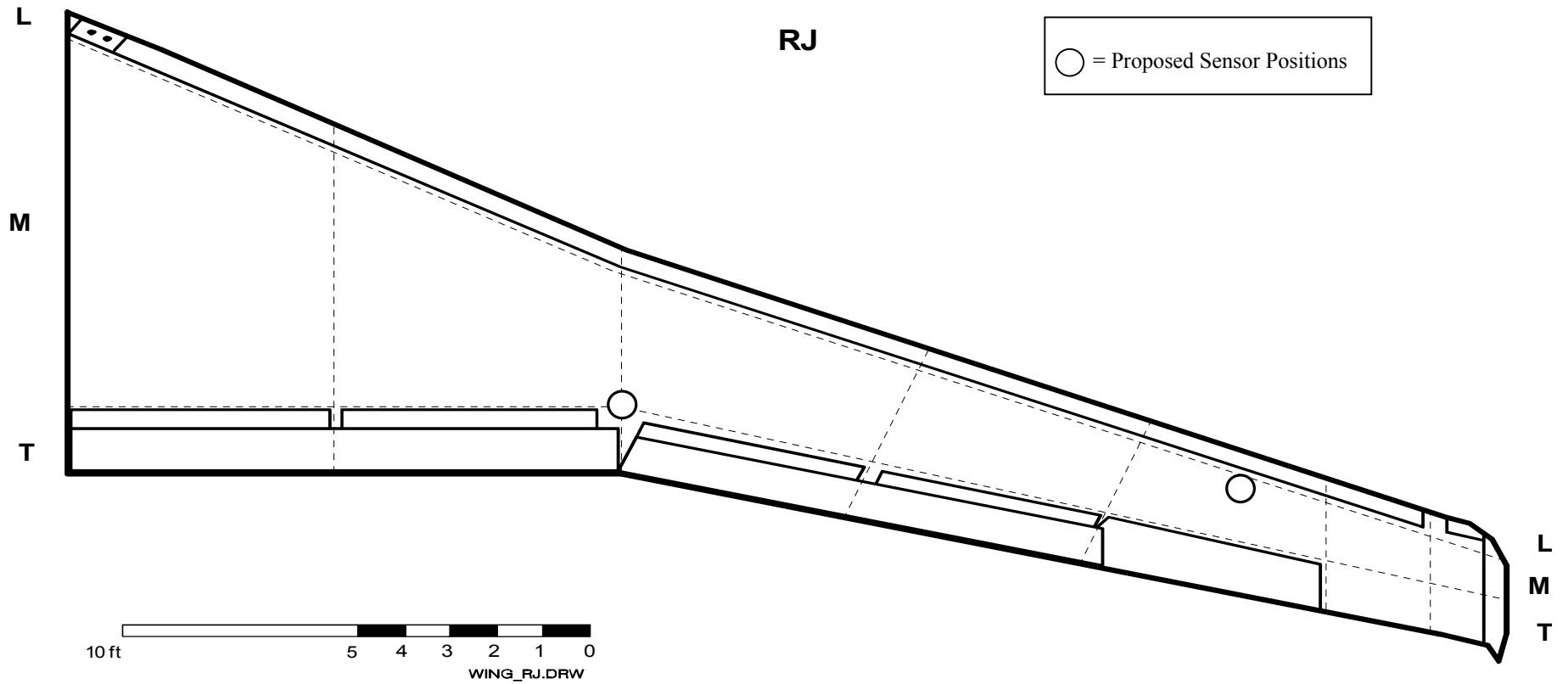

TABLE 3.1  
LISTING OF FULL-SCALE TESTS CONDUCTED IN 2000

ID #	Test Location	Date	Run No.	Airline	A/C Type	A/C Wing	Fluid Name (applied to wing)	Fluid Quantity (L)	A/C Dir. (deg.)	HOT End Precip. Rate (g/dm <sup>2</sup> /h)	Calculated Wind Head/Tail/Cross	Air Temp (°C)	Wind Speed (km/h)	Wind Direct. (deg.)	Wing HOT	Wing HOT	Wing First Fail	Wing 10% Fail *	Wing Complete Fail **	AVG. (P1/P2) Fail Time XL54-heated	AVG. (P1/P2) Fail Time ADF-warm	Plate 1 Fail Ultra +	Plate 2 Fail Ultra +	Average Rate (Plates) g/dm <sup>2</sup> /h	Precip. Type
															Start Time	End Time	(min)	(min)	(min)	(min)	(min)	(min)	(min)	(min)	(min)
1	YUL	Jan-26-00	1	Air Canada	RJ	Port	XL54	55	90.0	3.0	Cross	-6.6	23	323	1:16	2:10	37	41	54	48.7	45.2			2.1	S
2	YUL	Jan-26-00	2	Air Canada	RJ	Strbd	XL54	66	90.0	3.0	Cross	-6.6	22	320	1:18	2:07	37	40	48	48.7	45.2			2.0	S
3	YUL	Jan-26-00	3	Air Canada	RJ	Port	XL54	74	90.0	9.1	Cross	-6.6	22	346	2:21	2:37	7	11	15	12.7	10.3			8.6	S
4	YUL	Jan-26-00	4	Air Canada	RJ	Strbd	XL54	66	90.0	9.1	Cross	-6.6	21	347	2:23	2:38	7	12	14	12.7	10.3			7.6	S
5	YUL	Jan-26-00	5	Air Canada	RJ	Port	XL54	89		24.0	Tail	-6.8	18	346	3:26	3:40	4	8	14	4.8	3.6			26.3	S
6	YUL	Jan-26-00	6	Air Canada	RJ	Strbd	XL54	74		24.0	Tail	-6.8	17	346	3:28	3:39	4	6	10	4.8	3.6			26.3	S
7	YUL	Jan-26-00	7	Air Canada	RJ	Port	XL54/Ultra +	92/43		14.0	Head	-7.0	15	329	3:57	N/F	17	37	N/F			N/F	N/F	13.9	S
8	YUL	Jan-26-00	8	Air Canada	RJ	Strbd	XL54	79		13.8	Head	-6.9	15	331	4:00	4:16	5	7	15		4.6			16.6	S

\* FAILED FLUID OVER 10% OF WING AREA

\*\* FAILED FLUID OVER ENTIRE WING AREA

NF = Not Failed

AVG. (P1/P2) = Average for 2 plates

Table 3.2 provides a comparison of the wing failure times to the failure times at potential C/FIMS locations.

Figure 3.2 provides an example of a wing failure diagram recorded during the full-scale test session. The diagram corresponds to Run 2. The times are recorded on the right-hand side of the page and the failure patterns are shown as shaded areas on the wing diagrams.

Figure 3.3 shows the localized form for test Run 2. This form was used to record the failure times at pre-selected failure levels for the two sensor locations. The times and the percentage of the sensor locations that failed were written on the wing diagram. The full set of failure diagrams is included in Appendix C.

Precipitation rates were measured on the test stand located near the van. The rates recorded from the test pans are shown in Figure 3.4. A test-by-test breakdown of the precipitation rates recorded on the test stand is included in Appendix D.

TABLE 3.2  
**FULL-SCALE C/FIMS LOCATION DATA ANALYSIS**

Run #	A/C Wing	Fluid Type	C/FIMS Location	Precip. Rate (g/dm <sup>2</sup> /h)	Start Time (hh:mm:ss)	C/FIMS 10% Fail Time *	C/FIMS Complete Fail Time **	Wing First Fail (min)	10% of Wing Area Fail (min)	Wing Complete Fail (min)	C/FIMS 10% Fail (min) *	C/FIMS Complete Fail (min) **
1	Port	Type I	A1	3	1:16:05			37:35	41:05	54:25		
			A2				2:06:00					49:55
2	Strbd	Type I	B3	3	1:18:28	2:05:00	2:07:00	37:32	40:32	48:32	46:32	48:32
			B4			2:02:00	2:04:00				43:32	45:32
3	Port	Type I	A1	9.1	2:21:10			07:50	11:50	15:50		
			A2				2:33:00					11:50
4	Strbd	Type I	B3	9.1	2:23:50	2:37:00	2:38:00	07:10	12:10	14:10	13:10	14:10
			B4			2:36:00	2:38:00				12:10	14:10
5	Port	Type I	A1	24	3:26:00			04:00	08:00	14:00		
			A2									
6	Strbd	Type I	B3	24	3:28:08	3:35:00	3:37:00	04:52	06:52	10:52	06:52	08:52
			B4			3:38:00	3:39:00				09:52	10:52
7	Port	Type I / IV	A1	14	3:57:15			17:45	37:45	***		
			A2									
8	Strbd	Type I	B3	14	4:00:40	4:10:00	4:12:00	05:20	07:50	15:20	09:20	11:20
			B4			4:12:00	4:15:00				11:20	14:20

\* FAILED FLUID OVER 10% OF C/FIMS SENSING SURFACE

\*\* FAILED FLUID OVER ENTIRE C/FIMS SENSING SURFACE

\*\*\* TEST STOPPED PRIOR TO FAILURE

FIGURE 3.2

DE/ANTI-ICING FORM FOR AIRCRAFT WING

REMEMBER TO SYNCHRONIZE TIME

VERSION 4.0

Winter 97/98

DATE: January 26, 2000	RUN NUMBER: 2
------------------------	---------------

FAILURES CALLED BY: M . Chaput

COMMENTS: 900 kg of fuel on board

HANDWRITTEN BY: M . Chaput

ASSISTED BY:

DRAW FAILURE CONTOURS (hr:min) ACCORDING TO THE PROCEDURE

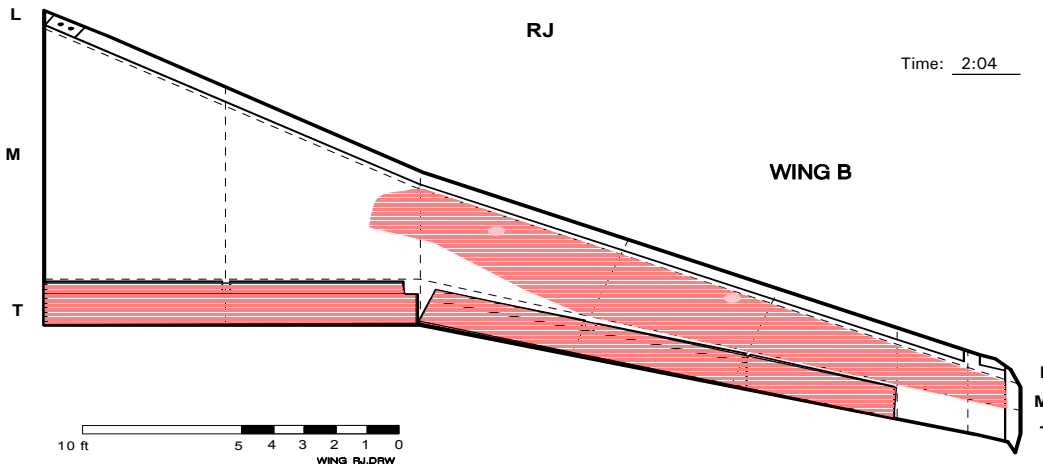
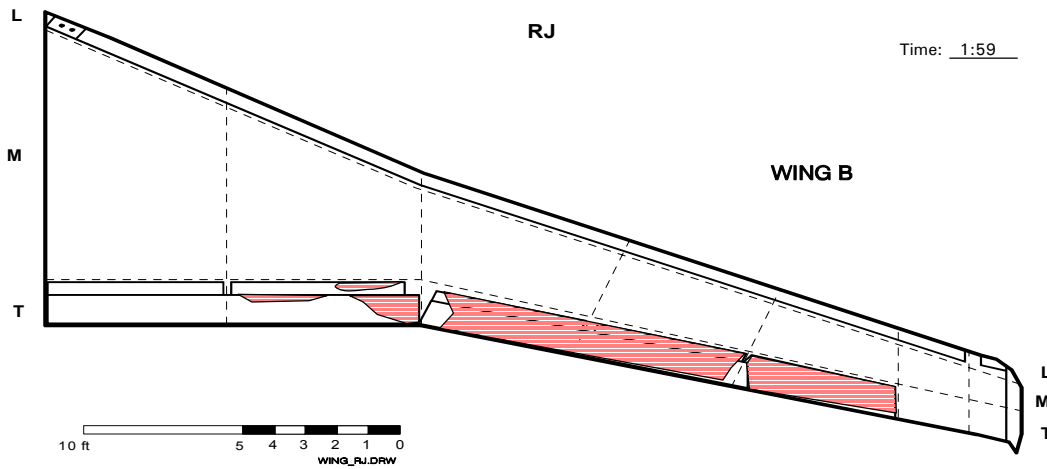
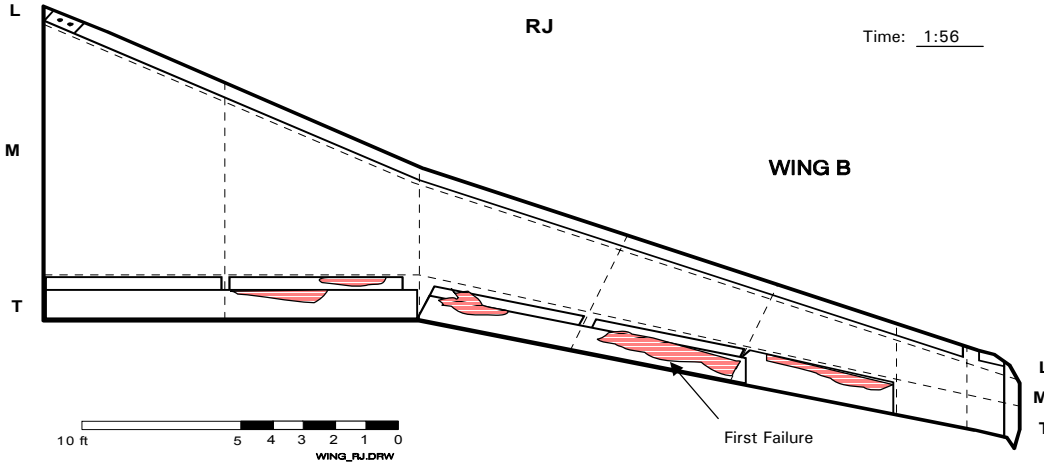

Note: To Compare to Flat Plate testing, subtract "Time of Initial Fluid Application".

FIGURE 3.3  
**LOCALIZED FORM FOR AIRCRAFT WING**

REMEMBER TO SYNCHRONIZE TIME

VERSION 4.0

Winter 1999/200

DATE: January 26, 2000	RUN NUMBER: 2
------------------------	---------------

FAILURES CALLED BY: M . Chaput

COMMENTS: \_\_\_\_\_

HANDWRITTEN BY: M . Chaput

\_\_\_\_\_

ASSISTED BY: \_\_\_\_\_

\_\_\_\_\_

**DRAW FAILURE CONTOURS (hr:min) ACCORDING TO THE PROCEDURE**

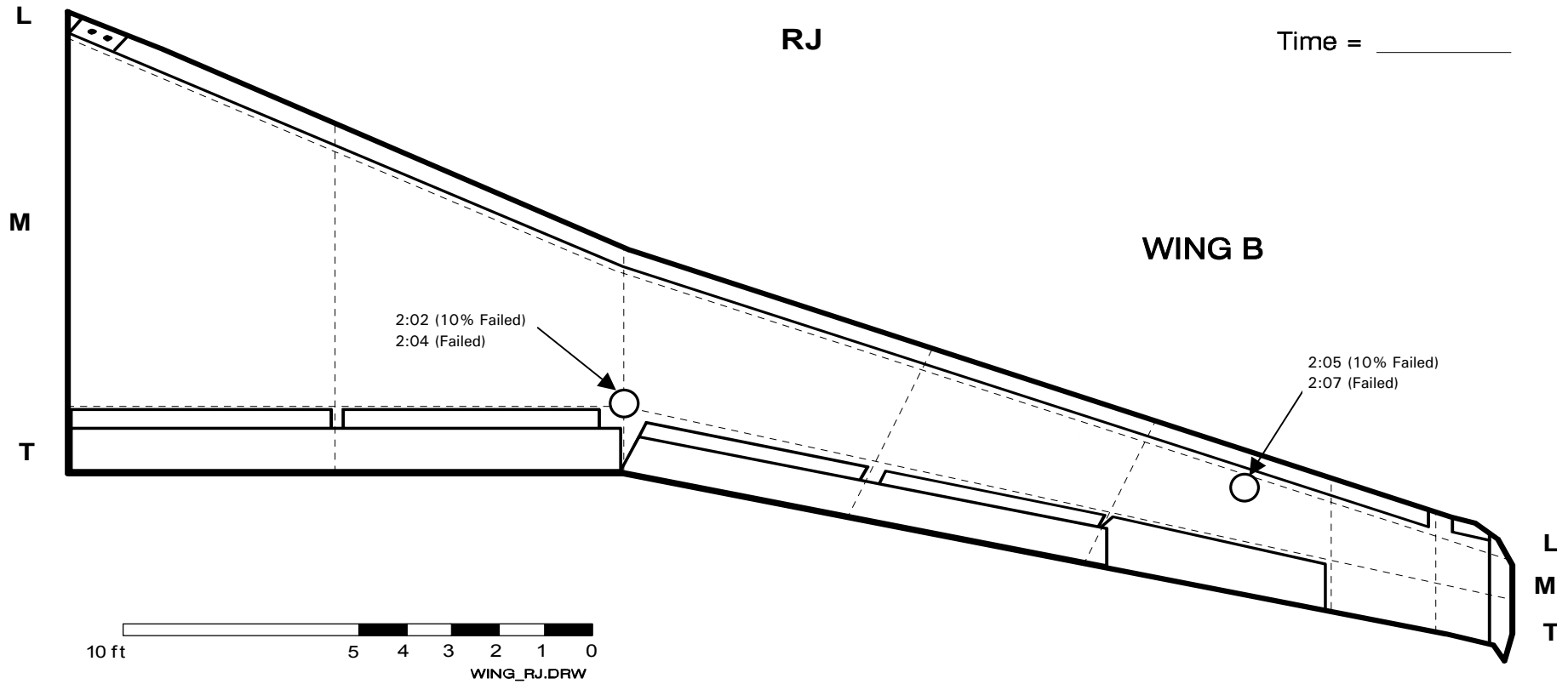
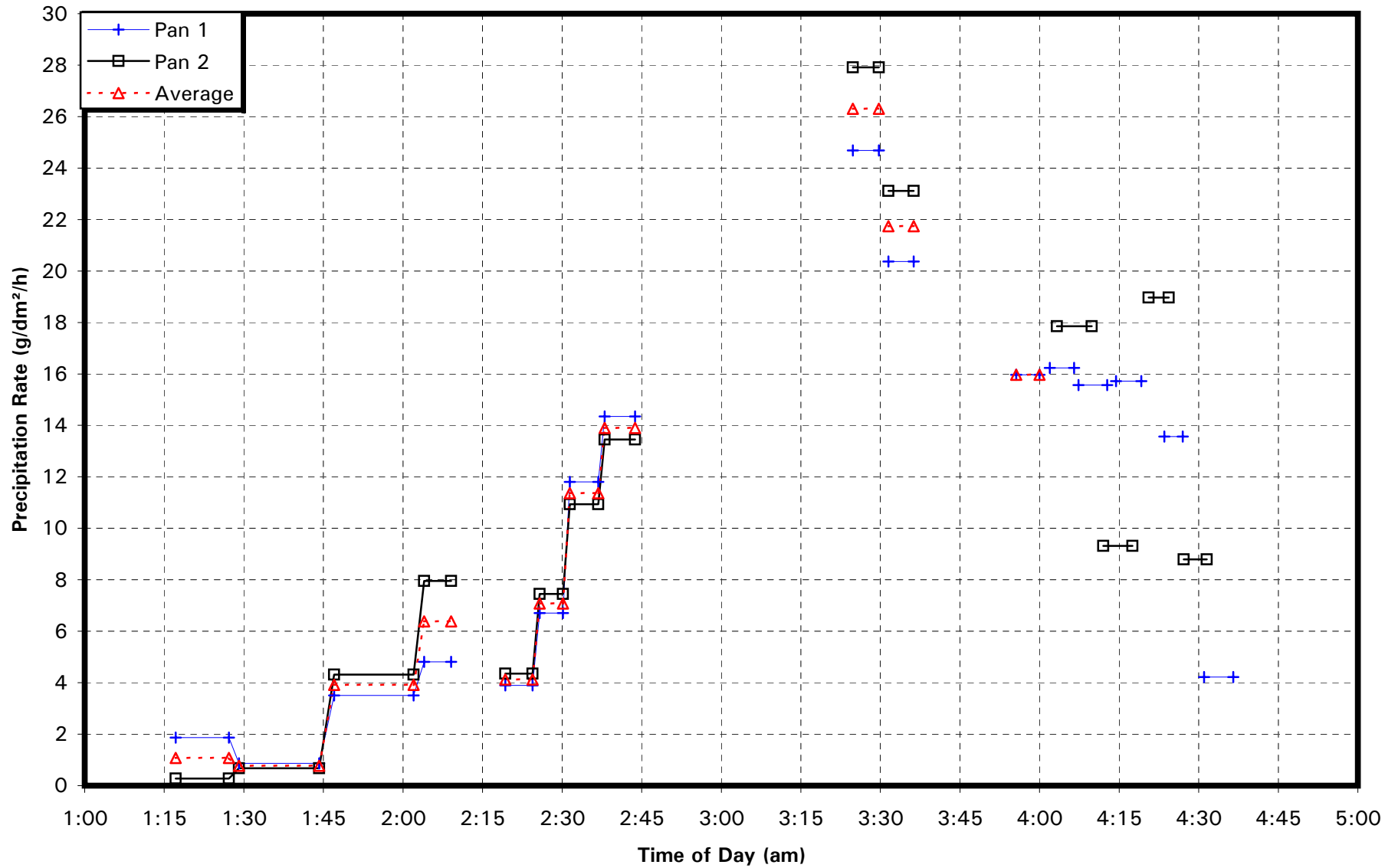



FIGURE 3.4  
 AIRCRAFT FULL-SCALE TESTS  
 PRECIPITATION RATES -- January 26, 2000



## 4. ANALYSIS AND OBSERVATIONS

This report contains the results from the tests that were conducted on a Canadair Regional Jet. In a previous study conducted for Transport Canada and documented in Transport Canada's report TP 13130E, *Aircraft Full-Scale Test Program for the 1996-1997 Winter*, it was found that aircraft type, and more particularly wing design, do affect the progression of failure. Flight control systems such as ailerons, flaps, slats and spoilers are well-defined sections of the aircraft wing, bounded by discontinuities. These discontinuities interrupt the flow of fluid onto the control surfaces from the main wing section and thus lead to local thinning and subsequent fluid failure at these locations. In general, the leading and trailing edges fail first, depending on aircraft type and wing design, followed by the mid-wing sections. For aircraft with hard wing design, such as the Fokker 100, initial failures primarily occurred on the trailing edge at the highest points of the ailerons and spoilers. The same pattern of fluid failure was observed to occur on the Canadair Regional Jet, which also has a hard wing leading edge design. This was particularly true for the Type I fluid tests. For the single Type IV test, a small amount of contamination was observed early in the test on the nose of the leading edge.

### 4.1 Fluid Failure at Proposed Sensor Locations

The wing failure pattern data was combined with the fluid sample data collected during each test to create graphs showing the fluid freeze point progression on both the leading edge and the trailing edge. A sample graph is shown in Figure 4.1. The graph also serves to compare the time to failure of a fluid on the wing wherever it might occur against the time to failure of the fluid recorded at the potential sensor locations. The complete set of graphs is included in Appendix E.

The fluid generally failed at the trailing edge before it failed at the sensor location. The sensor locations were chosen to accommodate the structural design of the aircraft wing.

The fluid tends to pool in the centre of the wing, closer to the proposed sensor location, and offers more protection there than areas near the leading edge and the control surfaces. On the control surfaces, the fluids run off due to gravity, and failures begin to progress from the edge of the control surface. This behaviour can be seen in all the failure diagrams recorded during the trials. In addition, when Type I fluid is applied, the control surfaces retain less of the fluid heat than the centre section of the wing.

FIGURE 4.1  
**FLUID FREEZE POINT TEMPERATURE PROFILE**

UCAR XL54, OAT = -7°C, 3.0 g/dm<sup>2</sup>/h, 23 kph

January 26, 2000 - ID # 1

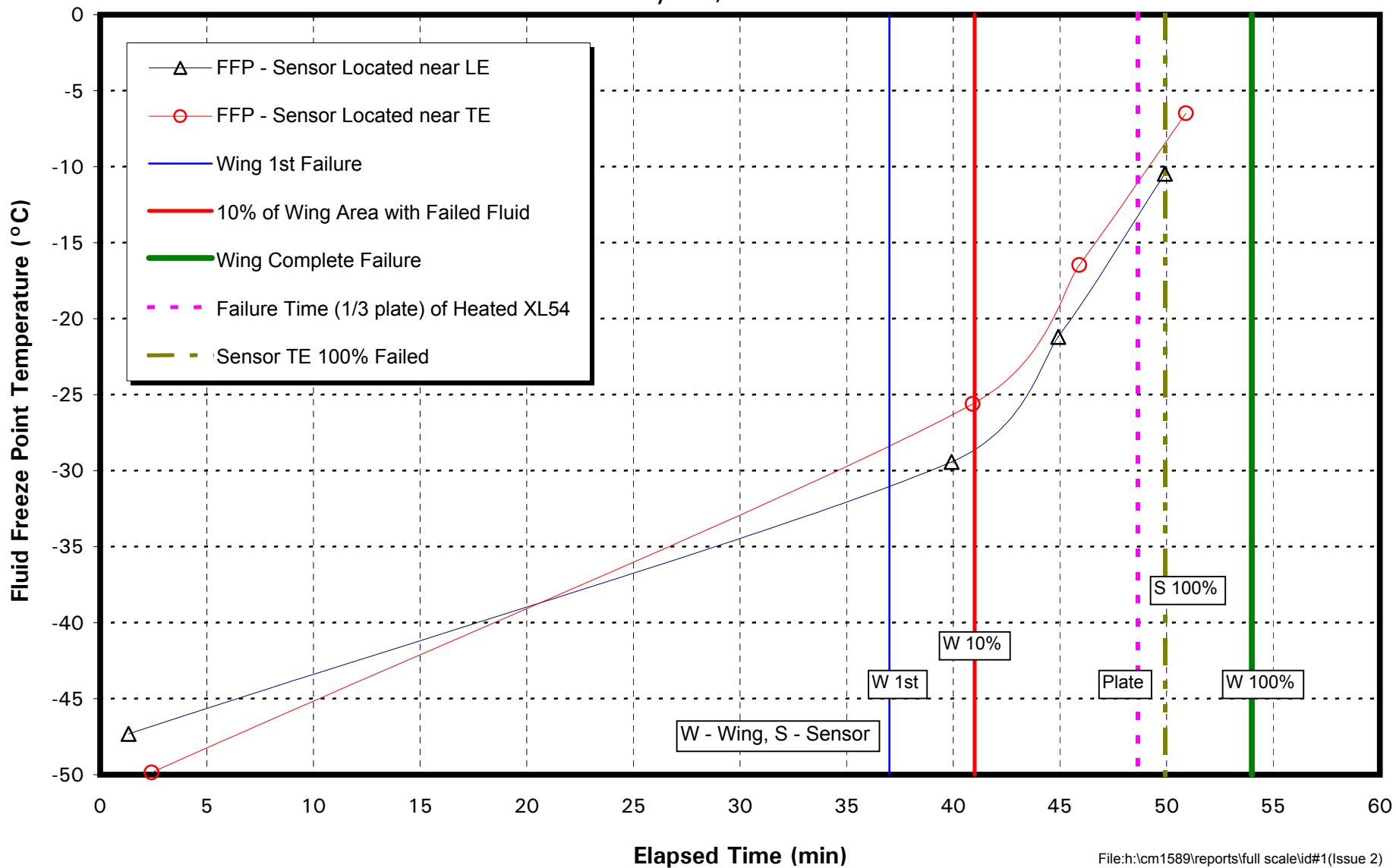

To obtain fluid failure times on the sensor locations that better represent the fluid failure times for the wing in general, it was suggested that the sensor head might be raised above the surrounding surface. Raising the sensor could potentially stimulate failure times closer to the times of the control surfaces. Flat plate trials designed to reproduce this geometry were conducted late in the season at the Dorval test site during snow precipitation. These trials are discussed in Section 4.2.

Figure 4.1 and the related figures for the remaining tests contained in Appendix E show that the freeze point of the fluid measured near the proposed sensor positions ranges from about  $-10^{\circ}\text{C}$  to  $-30^{\circ}\text{C}$  when 10 percent of the fluid on the wing had failed. Ideally, sensor placement on the RJ should be on the trailing edge control surfaces, as these are the areas that display consistent failure. As this is not practical, an algorithm for the sensor could be developed to predict the condition of the fluid on the wing based on the condition of the fluid over the sensor head; however, it is not known whether the results would be of reasonable quality.

## 4.2 Standard Plate Failure Times

The standard flat plate failure times versus the wing failure times for each test are shown in graph format in Appendix F. A sample graph is given in Figure 4.2. The graphs contain the wing first failure time, time at which 10 percent of the wing area has failed fluid, and time at which fluid over the entire wing failed. Also included on the graphs in Appendix F is the failure time for the plate tested with hot XL54 fluid and warm ( $20^{\circ}\text{C}$ )  $10^{\circ}\text{C}$  buffer ADF fluid.

The Type I failure times of fluid on the standard flat plates and the failure times of the fluid on the wing are summarized below (taken from Table 3.1) for each ID#.

ID#	Standard Plate Failure Time (min)	First Failure on Wing (min)	Fluid Failure on 10% of Wing Area (min)
1	45	37	41
2	45	37	40
3	10	7	11
4	10	7	12
5	3.6	4	8
6	3.6	4	6
8	4.6	5	7

FIGURE 4.2

### PLATE AND WING FAILURE TIMES FOR RUN 1

XL54 Fluid, OAT = -6.6°C, Rate = 3.0 g/dm<sup>2</sup>/h, Crosswind, Upwind Wing

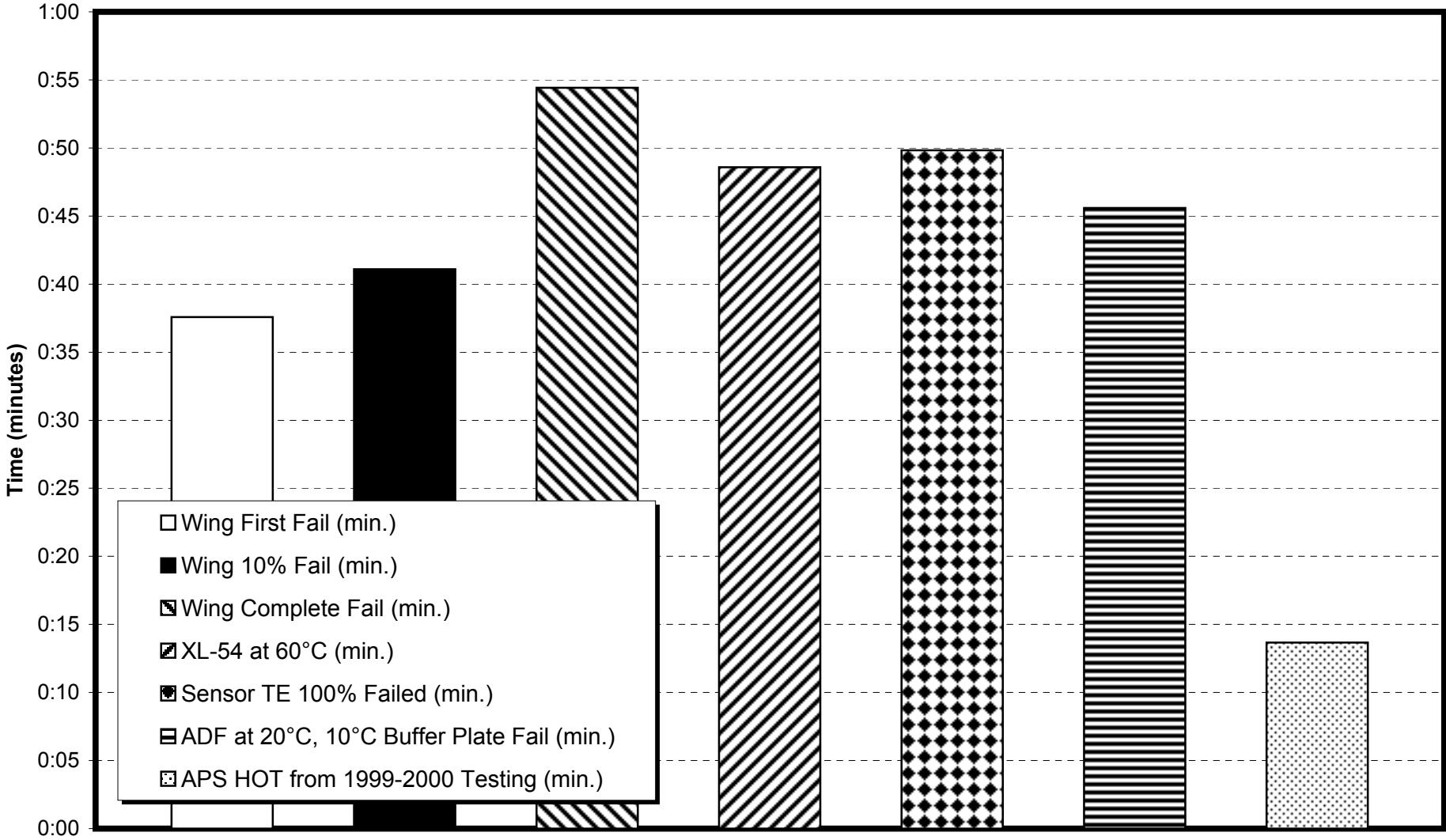

Note: Current SAE Type I HOT is 6 to 15 minutes

It can be observed from Table 3.1 that the standard plate failure times did not coincide with the same wing failure level during each test. This was also observed during the similar full-scale tests that were completed previously on different aircraft and documented in Transport Canada report TP 13130E *Aircraft Full-Scale Test Program for the 1996/97 Winter*.

The temperature of the fluid applied to the test plate influenced the failure times recorded for the plate. Tests were simultaneously conducted with warm 10°C buffer ADF fluid and hot XL54 fluid. The hot XL54 fluid outlasted the warm ADF fluid in all trials.

### 4.3 Type IV Failure Patterns

One Type IV test was conducted during the full-scale test session. The fluid was applied to the wing in a standard two-step application. The airplane wing was cleaned with hot XL54 fluid and then covered with Ultra+. The onset of failure occurred very quickly during the Type IV fluid trial. The first failure was detected on the leading edge of the wing, 18 minutes after the start of the test. The failure front progressed to 10 percent of the wing area 37 minutes after the fluid application. The test was not continued until complete wing failure was observed because of time limitations.

At the time when the test was stopped (approximately 04:40), about 20 percent of the wing surface was covered with contamination. Fluid failures (1/3 of plate area) had not been detected on the test plates when the test was stopped. The two plates had fluid that was contaminated to a level below the 2.5 cm line when the test was stopped. Based on the holdover time regression and given the ambient temperature and precipitation rate, the expected fluid failure time for 1/3 of the test plate should have been approximately 52 minutes.

Based on the findings of this trial, the failure patterns and failure times for Type IV fluids on RJ wings need further investigation. The initial failure times recorded were well below the holdover time.

### 4.4 Raised C/FIMS Trials

Preliminary raised sensor trials were performed at the APS test site during natural snow holdover time trials. The objective of these trials was to evaluate the possibility of raising the C/FIMS sensor heads by 1 or 2 mm to

reduce the failure times on the sensor heads. These tests were requested by AlliedSignal and TDC subsequent to the CL-65 test.

The trials were performed during the evening of March 11/12, 2000. The C/FIMS were raised by unscrewing the sensor head and placing a stopper in the cavity to prevent the sensor from being fully flush with the test plate surface. Tests were then run concurrently on three test plates. One plate had a sensor head raised by 2 mm, the second plate had a sensor head raised by 1 mm and the final plate did not have a raised sensor head. The three plates (30 cm wide x 50 cm long) were of the same thickness and tests were conducted simultaneously on all three plates. The position of the sensor head was centred at the bottom third of the plate (15 cm from the bottom of the plate).

The following fluids were tested:

**Table 4.1**  
**Raised Sensor Trials**

Run	Fluid Name	Fluid Type	% of sensor head covered with failed fluid at time of standard plate failure call		
			0 mm raised	1 mm raised	2 mm raised
1	UCAR XL54	I	0	40	40
2	UCAR XL54	I	0	70	50
3	SPCA 260	II	0	10	50
4	UCAR Ultra +	IV	0	*0	*0
5	SPCA 480	IV	0	*0	*0
6	SPCA 480 50/50	IV	0	10	100

Note: \*Failed after non-raised sensor head

The values in the table represent the percentage of the sensor head that was covered in failed fluid at the time when standard plate failure was called. Since the plates were rotated 180° from the standard orientation (i.e. the sensor was located 12" from the plate upper end), none of the non-raised sensor heads showed traces of failures at standard 1/3 plate failure. But, for example, in Run 3, 10 percent of the 1 mm raised sensor head area was covered in failure and 50 percent of the 2 mm raised sensor head area was covered with failure.

The raised sensor heads failed more rapidly in the trials with thinner, less viscous fluids. The Type I, Type II, and Type IV 50/50 fluids produce a stabilized thickness that is thinner (less viscous) than the neat Type IV fluids. During all the tests with these fluids, the edges of the raised C/FIMS dried and failure began to accumulate on the sensor heads before it accumulated in the surrounding fluid.

The neat Type IV fluids did not behave in the same manner. These viscous fluids accumulated near the raised sensor and provided additional protection from precipitation contamination. In all the Type IV tests, the raised sensor heads outlasted the non-raised sensor locations.



***This page intentionally left blank.***

## 5. CONCLUSIONS

### 5.1 Sensor Location Failures

In general, the fluid failed somewhere on the wing trailing edge prior to failure at the proposed sensor locations. The sensor locations had been chosen to accommodate the structural design of the aircraft wing. The fluid pools in the centre of the wing and offers more protection at the mid-chord, due to fluid quantity and heat, than areas near the leading edge and the control surfaces.

### 5.2 Plate Failure Times

Standard test plate failures did not coincide with the same wing failure level during each test. In some tests, the fluid on the standard plate failed (1/3 of plate covered with failed fluid) before the time of first failure on the wing, and in some tests, the fluid on the plate failed after the first wing failures. This was also observed during previous tests that were conducted on other aircraft types. The scatter in the test results was consistent with that observed in earlier tests.

### 5.3 Type IV Failure Patterns

One Type IV test was conducted during the full-scale test session. At the time when the test was stopped, over 20 percent of the wing surface was covered with contamination. Fluid failures had not occurred on the standard fluid test plates when the test was stopped.

### 5.4 Raised C/FIMS Trials

The raised sensor heads failed more rapidly in the trials with thinner, less viscous fluids. The neat Type IV fluids did not behave in the same manner. These viscous fluids accumulated near the raised sensor and provided additional protection from precipitation contamination.

Raising the sensor head may be a solution for Type I fluid use, but raising the sensor head for Type IV fluid application requires further investigation and research.

***This page intentionally left blank.***

## 6. RECOMMENDATIONS

Results from the single test session conducted on a CL-65 RJ aircraft proved insufficient to fully document the fluid failure pattern on the RJ wing. The single Type IV trial that was conducted showed early leading edge failures.

As a result, it is recommended that:

- More Type IV failure progression tests be conducted on CL-65 RJ aircraft to properly document the initiation and progression of fluid failure for this aircraft.
- Failure progression tests be conducted using other brands of Type IV fluid to identify differences in fluid performance and behaviour of these fluids on aircraft wing.
- A study of the impact of raising the sensor head be performed to determine the influence of various sensor elevations on the failure times at the selected sensor location. Tapering of the head with the adjoining surface should be considered.

***This page intentionally left blank.***

**APPENDIX A**

**WORK STATEMENT  
AIRCRAFT AND FLUID HOLDOVER TIME TESTS FOR THE 1999-2000  
WINTER**

EXCERPT FROM  
TRANSPORTATION DEVELOPMENT CENTRE

WORK STATEMENT

AIRCRAFT AND FLUID HOLDOVER TIME TESTS FOR WINTER 1999-2000

(December 1999)

**5.4 Aircraft Full-Scale Tests**

***5.4.1 Purpose of Tests***

The contractor shall conduct full-scale aircraft tests:

- To observe anti-icing fluid failure characteristics on aircraft vertical stabilizers under conditions of winter precipitation and simultaneously observe fluid failure behaviours on aircraft wings;
- To conduct the investigations of patterns of failure on the vertical tail fin using Type I and Type IV fluids, in nose, tail and crosswind conditions;
- To evaluate fluid failures on the vertical stabilizer as a surrogate for wing conditions;
- To examine fluid conditions at specific point sensor locations on the aircraft wing surface at the time of fluid failure;
- To generate data which can be used to facilitate the use of remote sensors for end-of-runway applications; and
- To compare the performance of de/anti-icing fluids on aircraft surfaces with the performance of de/anti-icing fluids on flat plates mounted at 10° and 80° to the horizontal.

***5.4.2 Planning and Co-ordination***

Planning and preparation for tests including provision of facilities, personnel selection and training, and test scheduling will be the same as provided to TDC in previous years.

### **5.4.3 Testing**

All tests and dry runs will be performed using the methodology developed in the conduct of similar tests for Transport Canada in past years. Two all night test sessions are planned. with the Canadair RJ.

Test planning will be based on the following aircraft and facilities:

<u>Aircraft</u>	<u>Airline Test</u>	<u>Location</u>	<u>Deicing Pad</u>	<u>Deicing Crew</u>
Canadair RJ	Air Canada	Dorval	Central	Aéromag 2000

### **5.4.4 Test Measurements**

The contractor shall make the following measurements during the conduct of each test:

- Contaminated thickness histories at selected points on the wings. The selection of test points will be made in co-operation with the Transportation Development Centre;
- Contamination histories at selected points on wings (selected in co-operation with the Transportation Development Centre);
- Location and time of first failure of fluids on the wings and the vertical stabilizer;
- Pattern and history of fluid failure progression;
- Time to failure of one third of the wing surface;
- Concurrent measurement of time to failure of fluids on flat plates. The plates will be mounted on standard frames and on aircraft wings at agreed locations;
- Wing temperature distributions;
- Amount of fluid applied in each test run and fluid temperature;
- Meteorological conditions; and
- For crosswind tests, measure effects of rate of accumulation on each wing.

In the event that there is no precipitation during full-scale tests, the opportunity will be taken to make measurements of fluid thickness distributions on the wings. These measurements will be repeated for a number of fluid applications to assess the uniformity of fluid application.



#### **5.4.5 Remote Sensor Records**

The contractor shall record the progression of fluid failure on the wing using RVSI and/or Cox remote contamination detection sensors if these sensors are made available.

### **5.5 Air Canada CL65 C/FIMS Evaluation**

The purpose of these trials is to collect data for evaluation of the proposed installation of two Allied Signal C/FIMS Ice sensors on an Air Canada CL65 to verify that they are optimally positioned on the wing surface. This evaluation will be made based on thickness measurements, over time, of Type IV fluids at several positions on the RJ during rain conditions. Additional tests will be conducted during freezing precipitation conditions during the winter to determine the patterns of failure.

Tests will be conducted at the Central Deicing Facility at Dorval Airport. Air Canada will provide and tow a CL65, either in the evening or overnight for tests to be conducted on three occasions. Both Air Canada and Aeromag shall be given a 24-hour notice of tests by the contractor. Union Carbide will provide fluid. The contractor shall monitor weather conditions and testing will be initiated when the forecast calls for rain (light rain is preferred) with calm winds, or freezing precipitation. The rain test is planned so that preliminary information can be gathered prior to getting winter weather and will also serve as a 'dry' run. Ambient temperature conditions during the rain tests should be as cold as possible. A total of three tests will be planned for each session.

**APPENDIX B**

**EXPERIMENTAL PROGRAM  
FULL-SCALE FLUID FAILURE TESTING**

CM1589.001

**EXPERIMENTAL PROGRAM  
FOR FULL-SCALE AIRCRAFT/FLUID FAILURE TESTING**

Winter 1999-2000

Prepared for

**Transportation Development Centre  
Transport Canada**

Prepared by: Marc Hunt

Reviewed by: John D'Avirro



January 18, 2000  
Version 2.0

**EXPERIMENTAL PROGRAM  
FOR FULL-SCALE AIRCRAFT/FLUID FAILURE TESTING  
Winter 1999-2000**

This document provides the detailed procedures and equipment required for the conduct of full-scale fluid failure testing for the 1999-2000 winter season. The document is a revision to the documents used for testing during the previous winters.

## **1. PURPOSE OF TESTS**

### **1.1 Objective**

- To observe anti-icing fluid failure characteristics on aircraft vertical stabilizers under conditions of winter precipitation and simultaneously observe fluid failure behaviours on aircraft wings;
- To conduct the investigations of patterns of failure on the vertical tail fin using Type I and Type IV fluids, in nose, tail and crosswind conditions;
- To evaluate fluid failures on the vertical stabilizer as a surrogate for wing conditions;
- To examine fluid conditions at specific point sensor locations on the aircraft wing surface at the time of fluid failure;
- To generate data that can be used to facilitate the use of remote sensors for end-of-runway applications;
- To compare the performance of de/anti-icing fluids on aircraft surfaces with the performance of de/anti-icing fluids on flat plates mounted at 10° and 80° to the horizontal; and,
- If possible, to generate data to be used to assess a pilot's field of view during adverse conditions of winter precipitation for selected aircrafts.

### **1.2 Applications**

- To determine the fluid failure times on the vertical fin in various wind conditions;
- To observe the failure propagation on flat plates and a full-scale aircraft vertical stabilizer in similar precipitation conditions; and
- To obtain calibration data for the proposed locations of Allied Signal C/FIMS Ice sensors on an Canadair CL-65 RJ.

## **2. AIRCRAFT, TEST LOCALE, AND TEST SET-UP**

- Aircraft: Canadair CL-65, an aircraft with wing-mounted engines (i.e. horizontal stabilizer at the base of the vertical stabilizer)
- Locale: Dorval International Airport, Montreal, Central Deicing Facility
- Test Set-up:
- Aircraft out-of-service, overnight tests based on predicted precipitation 24 hrs notice;
  - Aircraft cabin accessible for simulated pilot inspection of critical surfaces;
  - Aircraft parked at pre-determined orientation prior to start of test. Re-orientation required during each one-night test session;
  - De/anti-icing to be performed by AéroMag 2000 Inc; and
  - Aircraft to be deiced and returned to service condition at completion of tests (prior to first airline use in the morning).

## **3. TEST PROGRAM**

A matrix of tests is anticipated based on:

- Headwind, crosswind, and tailwind orientations;
- Application of Deicing, and De/Anti-icing fluids; and
- Snow, freezing drizzle or light freezing rain precipitation.

Test Period (nominal):

- Early Dec. 1999 – 31 Mar. 2000;
- No tests on Sat/Sun & Sun/Mon overnights, and period 18 Dec. 1999 – 3 Jan. 2000, inclusive, unless by prior agreement; and
- A total of two one-night test sessions is anticipated, which may be preceded by a *dry run* if necessary.

## 4. EQUIPMENT

Test equipment required for the tests is provided in Attachment I. Details and specifications for some of the equipment is provided in the experimental plan developed for Dorval's standard flat plate testing *Experimental Program for Dorval Natural Precipitation Testing 1999/2000*.

## 5. PERSONNEL

Several personnel are required to conduct tests for each occasion. A description of the responsibilities and duties of each of the personnel is provided in Attachment II. Depending on the weather forecast at the site, the number of personnel may be reduced or increased. Figure B-4 shows a schematic of the positioning of the test personnel. Ground support personnel from AeroMag 2000 and from the airlines will be available to apply fluids, position the aircraft, and facilitate the inspection of the critical aircraft surfaces.

## 6. SUMMARY OF PROCEDURE AND MEASUREMENTS

The test procedure is included in Attachment III. The following observations are anticipated:

- Trained observer assessment of wing condition from outside the aircraft.
- Fluid thickness histories: advantage will be taken of occasions when precipitation stops during the night to take thickness measurements on uncontaminated fluids.
- Comparisons of fluid performance on the aircraft with fluid performance on standard test plates.
- Video-record coverage of the tests.

## 7. DATA FORMS

The data forms are listed below:

• Figure B-6a	General Data Form (every test)	T5
• Figure B-6b	General Data Form (once per session)	T6
• Figure B-7a	De/Anti-icing Form for Aircraft Wing	T2/T4/T8
• Figure B-8	Localized Form for RJ Aircraft Wing	T10
• Figure B-9	Fluid Thickness on Aircraft	-
• Figure B-10	Fluid Thickness on Flat Plates	-
• Figure B-11a,b	De/Anti-icing Form for Vertical Fin	T11
• Table B-1	End Condition Data Form	T3
• Table B-2	Meteo/Plate Pan Data Form	T1

## 8. ROLES OF PARTICIPATING AGENCIES

APS: To coordinate and conduct tests on behalf of TDC.

TDC: Transport Canada or its contractor/representative will organize the tests. Transport Canada will assume the cost of trained observers, conduct of tests and provision of instrumentation, ancillary lighting, and power supplies. Transport Canada will make appropriate arrangements with Aéroports de Montréal as necessary, and with AéroMag 2000 Inc. for use of the deicing facility. Findings and reports will be made available to the aviation community.

Air Canada: Provide and tow aircraft.

Others: Fluid manufacturers will provide fluid samples. AéroMag 2000 will provide a deicing vehicle, personnel and access/use of the deicing centre. RVSI and/or Spar/Cox will be requested to provide a remote sensor.

## 9. PROPOSED GIVEN NOTICE PROCEDURE

	<u>Notice given</u>
1. Potential for testing	24 to 48 hrs before
2. Day of testing - Monitoring throughout day	By 4:00 pm
3. Day of testing - Confirm or cancel (if possible)	By 8:00 pm
4. Proceed to deicing pad	10:00 pm
5. Preparation/Briefing	10:00 to 11:00 pm

## 10. EQUIPMENT AND SERVICES REQUESTED FROM AIRLINES

Airlines are requested to make aircraft available for Transport Canada to implement the above test program.

Aircraft to be initially positioned, re-positioned following individual tests, and towed away at end of each one-night test session.

AéroMag 2000 Inc. is requested to provide a de/anti-icing truck with crew for fluid application in accordance with the above program.

Direct cost of crew to be borne by contractor. Credits for fluids will be given by the fluid manufacturer.

ATTACHMENT I  
 FULL-SCALE FLUID FAILURE TESTS  
**TEST EQUIPMENT CHECKLIST**

<b>Logistics for Every Test</b>	
15 Block Passes	
Rent two mast lights	
Rent Truck	
Call Personnel	
Advise Airlines (Personnel, A/C Orientation, Equip)	
Monitor Forecast	
Call potential participants	
Book escort if required (24 hour notice)	
<b>Test Equipment</b>	
15 Procedures	
All data forms required (wing, plates, general)	
1 Portable test stand with 4 x 1/8" thick plates W,X,Y,Z	
2 Mast lights and 1 spare generator	
3 x 500 Watts tripod lights	
Red pylons	
6 Rolling stairs(2 Tall, 2 Med, 2 Small)	
7 Step ladders (2 Tall, 2 Med, 2 Small, 1 Short for truck)	
Stand fluids: Type I and Type IV in red containers	
4 Extension chords stored in bin.	
1 tool kit including socket set, hammer, tie-wraps, duct tape, safety goggles, spare Batteries (AA, D)	
1 parabolic heater	
2 Suction cup plate pans	
2 Standard plate pans	
2 Wide plastic shovels, 2 small steel shovels	
2 large and 2 small squeegees	
4 small plate scrapers	
Pens and pencils	
Paper Towels and rags	
1 First aid kit	
4 extended octagon thickness gauges + 4 ordinary Octagon thickness gauges	
1 Rates station with 1 weight scale from test site, 1 table for station	
Rain suits	
2 Stop watches	
2 Two black markers	
3 Tape measures (1 long, 2 standard)	
1 whistle	
3 Flashlights	
5 Clipboards	
2 Ink solvent bottles	
1 Anometer	
2 Temperature gauges (1 extended tip and 1 normal tip)	
2 Laser pointers	
5 Head set radios and chargers	
2 Brixometers	
2 Tape recorders	
Extra mini cassettes for tape recorders	
24 video cameras power batteries, 1 belt power pack, and 1 power regulator	
3 Video camera CR2025 spare batteries	
9 x 8 mm films	
3 Video camera batteries chargers	
2 Photo cameras 35 mm, 1 Nikkon, 1 Snappy	
Plastic glue for video cameras	
35 mm film	
1 video camera AC cable	
3 Photo camera lithium 223 power batteries	
1 video camera RCA cable	
1 Megaphone	
Garbage bags	
1 Filling pocket for data forms	
2 Tripods for video/photo cameras	
All individual kit boxes: V1, V2, P1, T3, T2/T4, T5, T6, T7, T8, T10, T11 Sampling, Marking	
1 Adherence tester (dental floss device)	
1 Big Clock	
<b>OTHER TEST EQUIPMENT (1)</b>	
Type I fluid for the wing	
Type IV fluid for the wing	
Sprayer Vehicle (Aeromag)	
A/C	
Storage Facilities	
Fluid Collection Facilities	
Airline Personnel	

} video and camera equipment

(1) To be provided by others



*This page intentionally left blank.*

**ATTACHMENT II  
Full-Scale Fluid Failure  
RESPONSIBILITIES/DUTIES OF TEST PERSONNEL**

Refer to Figure B-4 for position of equipment and personnel relative to the aircraft. Also refer to the test procedure (Attachment III) for more detailed test requirements.

**Video 1 (V1/V2)**

- One video operator per wing or vertical stabilizer;
- Located on ground (refer to the flat plate test procedure);
- Ensure proper plate identification – zoom in and out;
- Know test procedures and end conditions;
- Videotape application of all fluids;
- Assist in deployment and return of lighting;
- Videotape wing and vertical stabilizer before and after fluid application, concentrating on fluid contamination and failure; and
- Ensure proper identification of wing.

**Photographer (P1)**

- Photograph aircraft test site;
- Photograph wing and vertical stabilizer during and after fluid application, concentrating on fluid contamination and failure;
- Overall photography of wing and vertical fin condition is extremely important;
- Photograph fluid roughness on wing (refer to Attachment XI);
- Ensure picture is steady and well lit;
- Photograph both wings and vertical stabilizer (required); and
- Know test procedures and end conditions.

**Meteo/Equipment Tester (T1)**

- Co-ordinate all equipment (inventory and operation);
- Record meteo for both stands;
- Rotate pans and measure plate pan weights;
- Complete and sign meteo data form (Table B-2);
- Ensure power cables and lighting are in place;
- Prepare plate pans;
- Ensure all clocks are synchronized (including video camera); and
- Record rates on both aircraft wings during crosswind tests.

### **Wing Observers (T2/T4)**

- Located on ground (rolling stairs) or in cherry picker;
- Communicate with V1/V2 and P1, and T5;
- Make observations of failures on starboard or port wing; and
- Know procedures and calling end conditions.

### **End Condition Tester (T3)**

- Located by test stand;
- Apply fluids to test plates on stand;
- Make observations and call end conditions on test stand; and
- Know procedures for test stands.

### **Wing/Plate Co-ordinator (T5)**

- Ensure failure calls on plates and wings are consistent;
- Communicate initial failure to all involved;
- Assist wing and plate observers as required;
- Assist overall co-ordinator as required;
- Complete and sign general data form (Figure B-6a) for each test;
- Manage and direct equipment deployment and return;
- Assist T1 in co-ordination of equipment;
- Communicate with cabin observer the spraying of wing A and wing B;
- Review data forms upon completion of test for completeness and correctness (sign);
- Ensure proper documentation of tapes, diskettes and cassettes; and
- Call personnel to conduct tests.

### **Overall Co-ordinator (T6)**

- Act as team Co-ordinator;
- Know test procedures and calling end conditions;
- Be responsible for area and people;
- Aid any personnel;
- Co-ordinate actions of APS team and, as required, airline personnel;
- Be responsible for weather condition observations and forecast, advise tester team;
- Ensure that there are no objects on the ground that may cause foreign object damage at end of session;
- Ensure test site is safe, functional and operational at all times;
- Supervise site personnel during the conduct of tests;

- Ensure aircraft positioned appropriately;
- Monitor weather forecasts during test period;
- Ensure fluids are available and verify that correct fluids are being used for test;
- Ensure electronic data are being collected for all tests;
- Verify test set-up and procedure are correct (e.g. stand into wind);
- Ensure all materials are available (pens, paper, batteries, etc.);
- Ensure all equipment is on;
- Ensure aircraft is not damaged; and
- Complete general data form (Figure B-6b) at beginning of night.

### **RVSI and Spar/Cox (V1/S1)**

- Know procedures and calling end condition; and
- Take images of fluid failure on starboard and port wing.

### **Sampler (T8)**

- One fluid sampler for both wings;
- Collect fluid samples at first failure location and at several other points of failure;
- Communicate with T2/T4 for locations of failure;
- Know test procedures and end conditions;
- Measure wing temperatures at beginning of night; and
- Collect fluid samples from deicing truck at the start of testing.

### **Localized Point Wing Observers (T10)**

- Located on ground (rolling stairs) or in cherry picker;
- Communicate with V1/V2 and P1, and T5;
- Make observations of failures patterns at localized points on aircraft wing; and
- Know procedures and calling end conditions.

### **Vertical Fin Observer (T11)**

- Located on rolling stairs or in cherry picker;
- Communicate with V1/V2 and P1, and T5;
- Make observations of failures on vertical fin; and
- Know procedures and calling end conditions.

*This page intentionally left blank.*

## ATTACHMENT III TEST PROCEDURE

### 1. TRAINING AND SAFETY

Training for this experiment will consist of a *dry run* in which team members are assembled and duties are assigned to each member. This will allow the team to conduct an experiment in which team members will co-ordinate their activities to prepare for a systematic and comprehensive execution of a given experimental run and try to determine the logistics of an actual experiment. The dry run will familiarize all test members with the equipment and provide the participating airline with an understanding of the procedure. This procedure will inevitably be streamlined during field testing. Most team members should be familiar with salient aspects of flat plate testing. They should possess the ability to identify fluid failures and call end conditions.

Attachment V refers to Safety Awareness Issues for these tests. Ensure that these are observed and understood.

### 2. PRE-TEST SET-UP

Figure B-4 should be consulted in reference to the responsibilities.

1. Arrange favourable aircraft orientation (**leading edge, crosswind or trailing edge into the wind**) and place pylons below wings to delineate sections.
2. Set up power cords and generator.
3. Position stairs and lights.
4. Ensure temperature probes and weigh scale are functional.
5. Position flat plate test stand into the wind as per the flat plate test procedure. Note that this orientation may be different than that of the aircraft.
6. Position pre-filled test fluid containers, squeegees, and scrapers accordingly. (Type I fluids are stored inside at 20°C; Type IV fluids are applied at ambient temperature.)
7. Check cameras, sensors and recording devices for proper function.
8. Ensure proper illumination of test areas.
9. Position RVSI and/or Spar/Cox sensor on truck.
10. Establish communication between team members and co-ordinator.
11. Camera and test personnel ensure ability to identify laser pointer light signature.
12. Synchronize all timepieces including video cameras.
13. Ensure airline personnel are aware and knowledgeable of test procedures.
14. Prepare data forms in advance of all tests.

### 3. INITIALIZATION OF FLUID TEST

1. Ensure all aircraft de/anti-icing systems are off.
2. Measure and record fuel load in wing to be tested.
3. Measure wing skin temperature at predetermined locations before fluid application (see Figure B-6b).
4. Record all necessary data from fluid delivery vehicle (cherry picker): temperature, nozzle-type, fluid type, dilution of fluid, etc.
5. Record all general measurements and general information on the data forms.
6. Ensure all fluids are prepared to the appropriate concentrations.
7. Collect a sample of fluid from deicing truck.

### 4. EXECUTION OF FLUID TEST

1. Type I Fluid Application (Figure B-5a)
  - i. Apply Type I fluid with deicing vehicle to aircraft wing and vertical fin.
  - ii. Simultaneously with aircraft wing deicing, apply Type I from containers to plates V and Y.
2. Type IV Fluid Application (Figure B-5b)
  - i. Apply Type I and then Type IV to aircraft wing and vertical fin with deicing vehicle.
  - ii. Apply Type IV from containers to plate W and Z when application of Type IV to the aircraft wing begins.
3. Plate/wing coordinator sounds whistle once to confirm the beginning of test (after fluid application).
4. Put two plate pans on test stand and note time and initial weights (see Attachment XIII for rate procedure). Continue measuring every five minutes until end of test. Re-measure when second wing is started.
5. Take RVSI and Spar/Cox sensor images every 15 minutes (see Attachment XII for sensor procedure).
6. Continue testing until the end conditions are called for both flat plates.
7. Collect fluid samples as per the test procedure in Attachment VI.

## 5. HOLDOVER TIME (END CONDITION) TESTING

Holdover time testing will consist of: a) video/photo recording of all procedures and fluid failures; and b) visual monitoring and manual recording of failure data. Attachment X contains a typical procedure for recording contamination on the wing with a remote sensor.

### A) *Video/Photo Recording (V1/V2, P1)*

Camera recordings are to be systematic so that subsequent viewing of documented tests allow for the visual identification of failing sections of the wing surface with respect to the aircraft itself.

1. Record the complete fluid application on plates, the aircraft wing and the aircraft vertical fin from a distance.
2. Record the conditions of the flat plate set-up, the aircraft wing and the aircraft vertical fin at time = 0.
3. For Type I fluids, record conditions of aircraft wing, aircraft vertical fin, and flat plates every two minutes.
4. For Type IV fluids, record conditions of aircraft wing, aircraft vertical fin, and flat plates every five minutes.
5. Once the first failure on the wing, the vertical fin, or on the one-inch line is called, monitor (record) continuously until the end of the test.
6. Record condition of the wing and representative surface continuously from the aircraft cabin.

### B) *Visual Recording*

1. For the plates, refer to the flat plate test procedure for determination of the end condition.
2. For the aircraft wing and vertical fin, three ways to record visual observations have been devised.
  - i. Manual recording of failure contours on pre-printed data form (Figure B-7a,b). This is to be performed by person making the observations, and/or
  - ii. Observer may talk to a voice recorder, and/or
  - iii. Observer may talk directly to the video camera microphone.

In all cases, the methods would utilize the De/Anti-icing Form for Aircraft Wing (Figure B-7a,b), which is complementary to the video recording.

It was found in previous tests that using generic wing plans, available from the literature test forms, did not always provide accurate detail for the actual wings tested. Accurate wing details must be portrayed on the data form wing plan to support accuracy in drawing failure locations and



patterns. Modification of generic wing plans, based on inspection of actual aircraft wings sometime prior to the test session, is necessary;

Due to the rapid propagation of failures, especially in the case of Type I tests, the time and precise location of first failure was sometimes missed. In certain tests, rapid failure had progressed to the 25 percent level at the time of documenting the first failure contour. Procedures and training must emphasize the requirement to identify the precise location of first failure. Additional observers are to be assigned from the test team to assist in failure identification when rapid progress of failure is expected. A further discipline can be added by requiring observer to comment on wing conditions at defined intervals while awaiting the occurrence of first failure;

The pattern of failures should be drawn on the data form **every 5 minutes for Type I and every 15 minutes for Type IV after first failure on the wing or the vertical fin.**

When the first flat plate failure is reported at the 5th crosshair ( $\alpha$  of plate), the visual data recorder must acquire contours every 2 to 5 minutes, thereafter. Time increment is dependent upon weather. Process is continued until all flat plates have failed according to the end condition defined in the flat plate test procedure.

If the wing or the vertical fin fails before the first flat plate fails, continue data collection for wing and vertical fin via contour drawing and/or voice communication until all flat plates fail.

Wing/plate co-ordinator must confirm initial end condition calls on flat plate tests. Once the first flat plate fails at the six-inch line ( $\alpha$  of plate), the co-ordinator is notified and makes inspection of the wing and vertical fin contour drawing to confirm the accuracy of the data and instructs video camera operator to make a record of the area. The area should be located using a laser pointer. If the wing or the vertical fin starts to fail first, the co-ordinator must confirm this and simultaneously note areas of failure on the flat plates using the laser pointer.

Measure wing skin temperatures at the start of the evening. If the wing is cold-soaked, then continue monitoring the temperatures.

## 6. END CONDITION

Refer to the flat plate test procedure for this definition.

## **7. END OF TEST**

Plate/wing co-ordinator sounds whistle to confirm the full failure of wing (end of run). This occurs when all plates have reached the end condition (under heavy snow conditions, continue testing until nine crosshairs have failed) and when a substantial part of the aircraft wings leading/trailing edge has reached the end condition. Ensure all data collection is completed including plate pan measurements.

***This page intentionally left blank.***

**ATTACHMENT IV  
TEST PROCEDURE FOR FLUID SAMPLING**

1. Prior to the start of testing, the refractive index of the Type I and Type IV fluids in each truck should be taken using a hand-held refractometer and recorded on the sampler=s wing data form (Figure B-7a,b) for the first test run. As well, a Type IV fluid sample should be collected from each truck and placed in a small sample container. On each container, information such as the date, truck number, airport, operator and sample number should be recorded. The containers should then be stored in a safe location and returned to the test site following each test session.
2. At the beginning of the night, the temperatures at several locations on the wing (shown in Figure B-6b) should be taken by the sampler using a temperature probe mounted on an extension pole. Temperatures should be recorded in the box in Figure B-6b.
3. After the location of first wing failure has been identified by the wing observer, a fluid sample should be collected at this position. A small sample of fluid (average mixture) from this location should be placed in a hand-held Brixometer and the refractive index and sample time immediately recorded on a wing data form (Figure B-7a,b). Also, the skin temperature at this location should be taken. When recording sample times, Brix values and skin temperatures on the data sheet, simply circle the location on the wing plan and write in the information below the circle. Make sure that the written information is clear!
4. Subsequent wing samples should be collected using the same procedure at various points of failure on the wing (as indicated by the wing observer).
5. A new data sheet should be used by the sampler for each run.

***This page intentionally left blank.***

ATTACHMENT V  
SAFETY AWARENESS ISSUES

1. Review MSDS sheets for fluids at site.
2. Protective clothing is available.
3. Care should be taken when climbing rolling stairs due to slipperiness.
4. When moving rolling stairs, ensure they do not touch aircraft.
5. To take fluid samples or measure film thickness on the aircraft, ensure minimum pressure is applied to the wing.
6. Entry into the aircraft cabin is not authorized, except for cabin observer (T7), video (V1), or overall co-ordinator (T6). For these people, boots are to be removed at entrance.
7. When aircraft is being sprayed with fluid, testers and observers should be positioned away in the hold area (see Figure B-4).
8. First aid kit, water and fire extinguisher is available in trailer. Second first aid kit is available in mobile truck.
9. No smoking permitted on the ramp area and in trailer.
10. Care to be taken when moving generators and fuel for the generators.
11. Electrical cabling is needed to power lights – these will be positioned around the wing – do not trip over them. Do not roll stairs or other equipment over cables.
12. Do not walk by yourself in any area away from the pad or trailer – if required to do so, ask the coordinator T6 who will advise the security escort service.
13. Gasoline containers are needed to power the generators – ensure you know where these are.
14. Ensure lights and rolling stairs are stabilized so as not to damage the wing.
15. Ensure all objects and equipment are removed from deicing pad at end of night.
16. Ensure all markings removed from wing.
17. Personnel with escort required passes must always be accompanied by a person with a permanent pass.
18. Rolling stairs should always be positioned such that the stairs are into the wind. Small ladders should be laid down under windy conditions.
19. Turning propeller blades are a well recognized danger in ramp operations, and operators of propeller aircraft in general have strict procedures to ensure personnel are kept well away from danger zones during propeller operation.
20. Tests involving personnel not trained and experienced in ramp operations must take particular care to ensure safety of personnel.

*This page intentionally left blank.*

## **ATTACHMENT VI TEST PROCEDURE FOR MEASURING FLUID THICKNESS**

Fluid thickness tests on aircraft and flat plates will be conducted during periods of no precipitation. This may be during test events when snow or rainfall has ceased, or during dry runs.

The following instructions are to be followed when measuring fluid thickness:

- Use the MIL scale on the square or octagonal thickness gauge;
- Record the gauge of the tooth that is wetted;
- When measuring fluid thickness, follow offset routine to avoid inaccuracies related to depressions in fluid surface caused by previous gauge placement;
- Ensure the thickness gauge is perpendicular to the surface of the wing;
- Record time in seconds during the initial measurements when the rate of fluid thinning is fastest. Time to the nearest minute is acceptable for subsequent recording;
- Wipe gauge following each measure attempt; and
- Proceed as quickly as possible without sacrificing accuracy.

### **FLAT PLATES**

Thickness tests on flat plates consist of one-step procedure where only Type IV is applied:

- Apply some Type IV fluid on plate and squeegee to clean it;
- Apply Type IV fluid and record start time and all other data on fluid thickness data sheet shown in Figure B-10;
- Immediately proceed to measure and record thickness at 2.5 cm (1") and 15 cm (6") lines; and
- Repeat thickness measurements for 30 minutes, with higher frequency during the initial measurements, until fluid thickness is stabilized.

### **AIRCRAFT WING**

1. Locations where fluid thickness will be measured are shown in Figure B-9. Indicate measurement points using aluminium tape and a black marker. (The tape will be stuck to the wing and the maker will be used to write on the tape. Ensure all tape is removed at the end of the session.)
2. Fluid thickness will be measured four times: two initial fluid thickness measures taken immediately following fluid application, and subsequently at 10 minutes and at 30 minutes following fluid application.



3. Measure each location three times to increase reliability of results; record the thickness measure resulting from these consecutive trials. Ensure that the thickness gauge placement for consecutive measurements is slightly offset from previous placement to avoid influence of indents remaining in fluid film. Wipe gauge following each measure attempt.
4. Record data on the Fluid Thickness Data Form, Figure B-9, in the format shown; measurement location, time, gauge reading.

ATTACHMENT VII  
MOBILE EQUIPMENT FOR EACH TESTER

- Video V1/V2*
- batteries
  - video camera
  - charger
  - 8 mm film
  - pens/pencils
- Photographer P1*
- photo camera
  - batteries (for 35 mm camera)
  - 35 mm films
  - pens/pencils
  - VHF radio
- Meteo/Equipment T1*
- pens/pencils
  - stop watch
  - clipboard
  - data form (Table B-2)
  - plate pans, plate pans with suction cups
  - mobile equipment for truck (see Attach. VIII)
- Wing/Plate Coordinator T5*
- test procedure
  - stop watch
  - laser pointer
  - flashlight
  - data form (Figure B-6a)
  - pens/pencils
  - clipboard
  - compass
  - VHF radio
- Wing Observer T2/T4*
- data form (Figure B-7a,b)
  - laser pointer
  - pens/pencils
  - stop watch
  - clipboard
- End Condition T3*
- data form (Table B-1)
  - pens/pencils
  - stop watch
  - compass
  - clipboard

*Overall Coordinator T6*

- test procedures
- flashlight
- pens/pencils
- stop watch
- clipboard
- tape recorder (x1)
- data form (Figure B-6b) (x1)
- small tape measure
- VHF radio

*Mobile Marking Kit*

- tape measures – 1 long, 1 short
- marker
- ink remover solvent
- degreaser
- pencils
- aluminium tape

*Sampler T8*

- data form (Figure B-7a,b)
- clipboard
- Brixometer
- pens/pencils
- stop watch
- temperature probe
- skin temperature equipment

*Localized Wing Observer T10*

- data form (Figure B-8)
- pens/pencils
- stop watch
- clipboard

*Vertical Fin Observer T11*

- data form (Figure B-11 a,b)
- pens/pencils
- stop watch
- clipboard

**ATTACHMENT VIII  
MOBILE EQUIPMENT REQUIRED FOR TRUCK (VAN)**

1. Weigh scale x 2 (with battery backup)
2. Table and chairs
3. Light and electrical extension cable
4. Heater dish
5. Wind protection booth
6. Step ladder (non-slip)
7. Plate pans
8. Skin temperature equipment
9. Mobile box with extra:
  - pens and pencils
  - data forms
  - clipboard
  - batteries
  - paper towels
  - flashlight
  - thickness gauge
  - test procedure
  - first aid kit
  - fire extinguisher

***This page intentionally left blank.***

**ATTACHMENT IX  
PROCEDURE FOR ROUGHNESS ON AIRCRAFT WING**

**Equipment:**

- 35 mm camera with date back and macro lens;
- Film – 35 mm 800 ASA;
- Walkie-Talkie;
- Spray paint – red, yellow, orange, purple, aquamarine, burgundy, blue;
- Markers – black, white; and
- Quarters – 16 (American).

**Details:**

- Each wing has been divided into seven sections (see wing diagrams);
- The seven sections on each wing have a designated colour;
- The coins have been painted according to the section colours;
- The coins are also indicated by an A (port wing) or B (starboard wing); and
- There should also be several unpainted quarters to indicate the point of initial failure on each wing.

**Procedure:**

- When the point of initial contamination is determined by the wing observer, an unpainted coin (bearing an A or B) is placed at this location and photographed plan, profile and overall (see explanation);
  
- When failures occur elsewhere on the wing (confirmed by wing observer), the colour designated coins should be placed in the appropriate sections and photographed plan, profile and overall (see explanation); and
  
- A final set of photographs for each section of wing is to be taken at end of test (wing failure).

**Three photos per location:**

1. Overall location of coin relative to the rest of wing;
  
2. Macro profile of coin to determine surrounding crystals' height, shape and size; and
  
3. Macro plan of coin to determine the roughness and texture of surrounding crystals relative to the coin.

FIGURE B-1  
INDEX OF COLOURS FOR PHOTOS OF ROUGHNESS ON AIRCRAFT WING

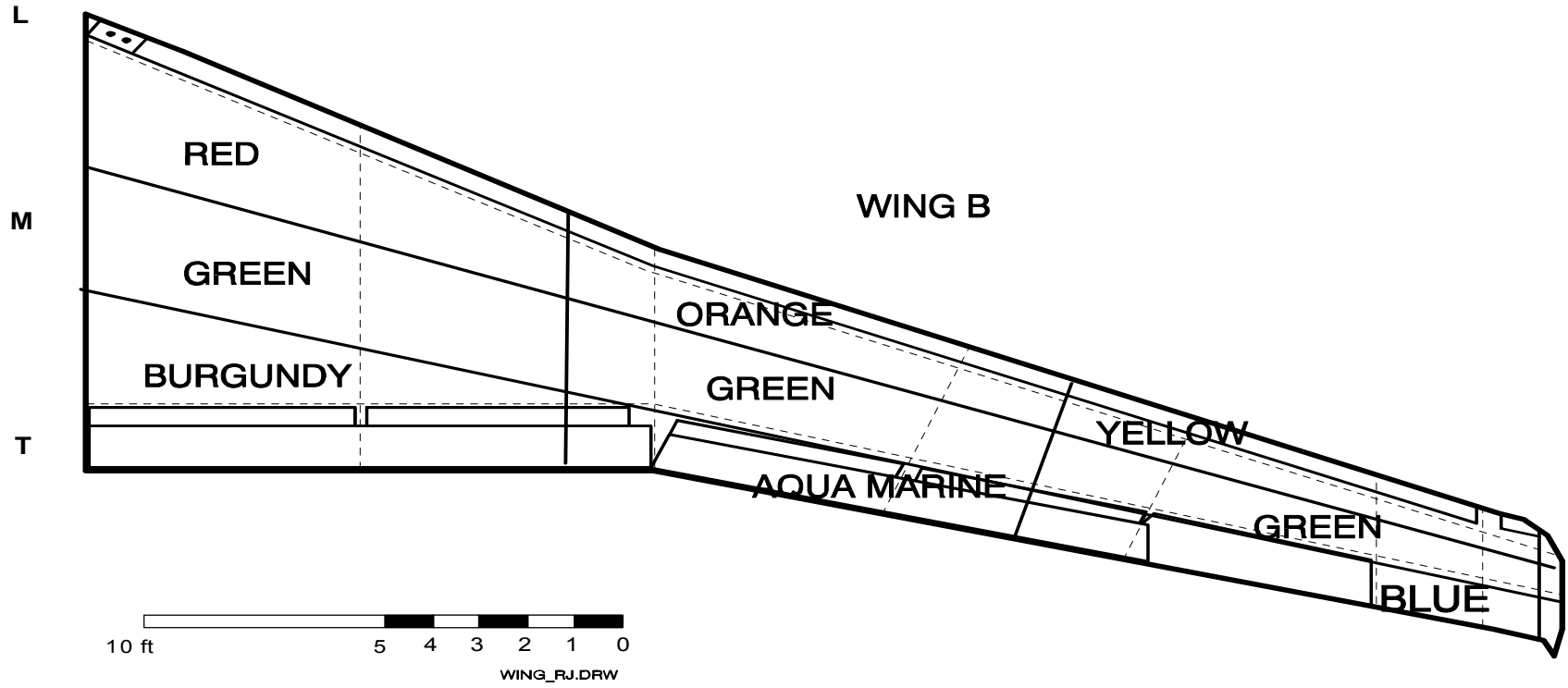

## ATTACHMENT X SENSOR PROCEDURES

### Test Procedure and Equipment

- At initial application of Type I fluid, the RVSI operator will take an image of the aircraft's tail identification numbers to determine fluid holdover time.
- Use a grid structure such as in the diagram to take images of the failure. Take four images across base of wing overlapping each frame. As you progress toward the wingtip fewer images are needed across the width of the wing. **(Try to include some identifying object in each frame to be able to easily identify frame location at a later date.)**
- Number of images taken is as follows: every fifteen minutes one entire series of images covering the wing should be captured.
- At the end of the test procedure the tail numbers will be imaged again to show that all previous images are associated with that particular aircraft.



Figure B-2 ID-1H SENSOR MODULE A HAND-HELD VIDEO SCANNING UNIT.

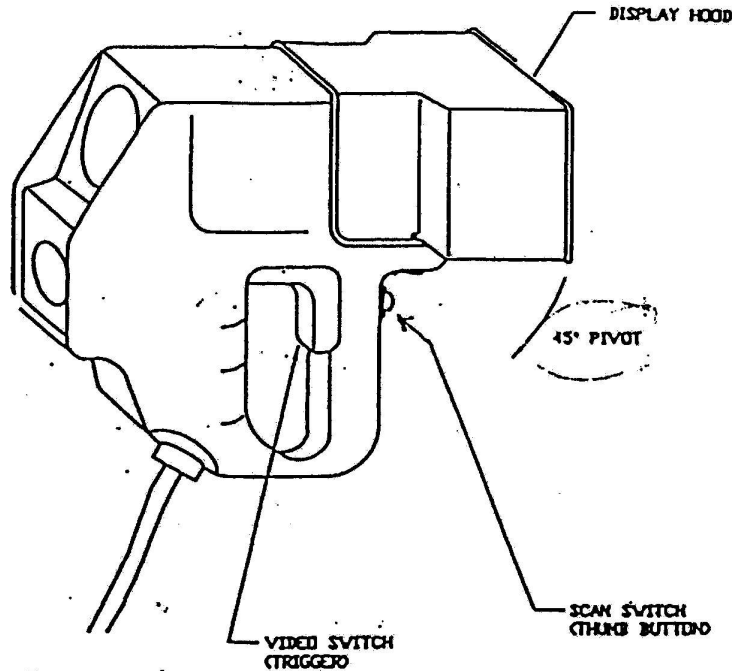

**Sensor Module Components:**

- Video Switch (trigger)
- Scan Switch
- Adjustable Display Screen and Hood

Pulling the video trigger will enable the viewer to see a real time video and record the area of the aircraft being checked. The display screen hood is adjustable for operating at various heights. *PIVOTS FOR COMFORTABLE VIEWING*

When taking a digitally enhanced image, Press and release the scan button. First a black and white still image will appear; then an enhanced image appears. Enhanced images are:

- Green indicates no contamination
- White indicates contamination
- Black means that the scanned object is out of range. This will give a range error message on the monitor.

Reinitiate the next video scan by depressing the scan button.

**FIGURE B-3  
BREAKDOWN OF BOEING 737-200 FOR RVSI ID-1H IMAGING**

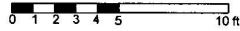
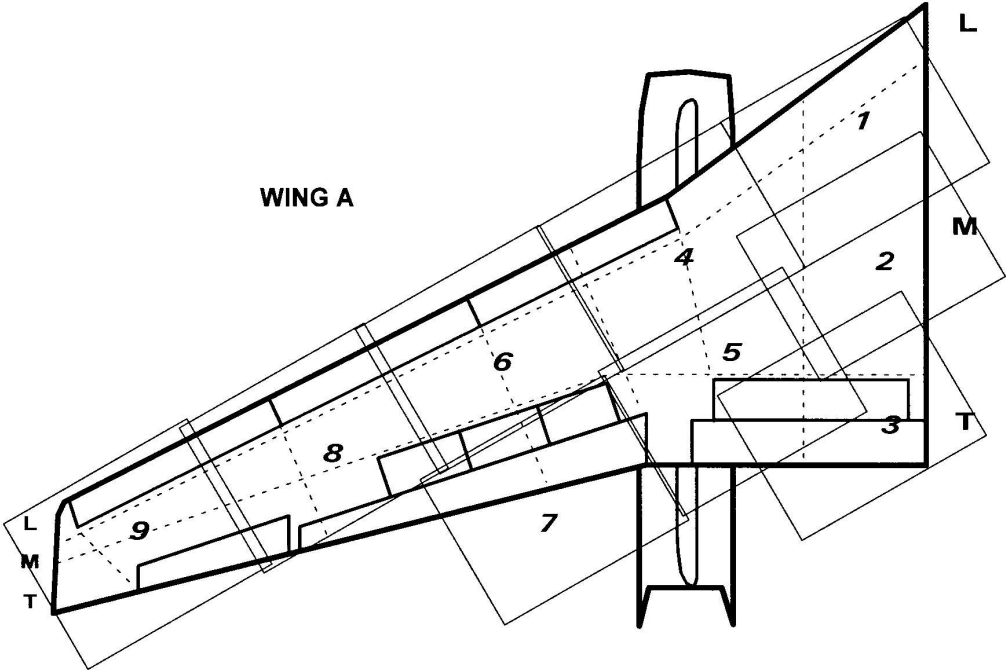

*This page intentionally left blank.*

ATTACHMENT XI  
EXPERIMENTAL PROGRAM  
PROCEDURE FOR THE COLLECTION OF PRECIPITATION  
Winter 1999/2000

**GENERAL**

1. A timepiece should be installed near the rate station to insure that accurate collection times are recorded. All watches used in testing should be synchronized;
2. Rates should be collected every five minutes;
3. In the event of error (dropped pan, lost fluid...), the error and time should be recorded on the data form. When fluid has been lost from the plate pans, pans should be reweighed prior to being placed on the test stand; and
4. When recording start and end times, a few seconds should be added or subtracted for the time delays created by entering and exiting the truck.

**PROCEDURE**

1. Ensure that both plate pans are marked (*upper* and *lower*);
2. The inner bottom and sides of the pan must be wetted with Type IV anti-icing fluid to prevent blowing snow from escaping the pan;
3. Tare the scale, then weigh the wetted pan to the nearest gram;
4. Record the start time (hr/min/sec) from the timepiece located near the rate station before leaving the truck to place the pans on the test stand, taking into consideration the time delay necessary to proceed outside from the rate station;
5. Ensure that the pans are placed in the proper location (upper and lower);
6. Prior to removing the plate pans from the test stand for reweighing, carefully wipe away any accumulated precipitation from the lips of the plate pans (ensure that the precipitation does not fall into the plate pan). Carefully remove the plate pans from the stand and proceed **immediately** to the truck to reweigh the pans. Do not rest the pans on top of one another while transporting. Once inside the truck, rest the pans on a clean dry table surface;
7. Upon entering the truck, record the end time (hr/min/sec) from the timepiece near the rate station;

8. Carefully wipe the bottom, sides and lips of the pans prior to weighing;
9. Weigh the plate pan. Plate pans should be reweighed until consistent measurements are obtained;
10. Record the new weight (do not tare scale again), and bring the pans back outside;
11. Record the start time from the timepiece near the rate station; and
12. Continue this procedure until the final plate on the test stand has failed.

## **CROSSWIND PROCEDURE**

During the course of full-scale tests conducted in crosswind conditions, rates of precipitation will be collected on both aircraft wings as well as on the test stand. Plate pans with suction cups will be used for this purpose, and the rate collection procedure should be respected. One plate pan should be positioned on the mid-section of each wing (not on the leading or trailing edges). Plate pans should be reweighed following complete wing failure for Type I tests and every 15 minutes for Type IV tests.

FIGURE B-4  
**POSITION OF EQUIPMENT AND PERSONNEL**

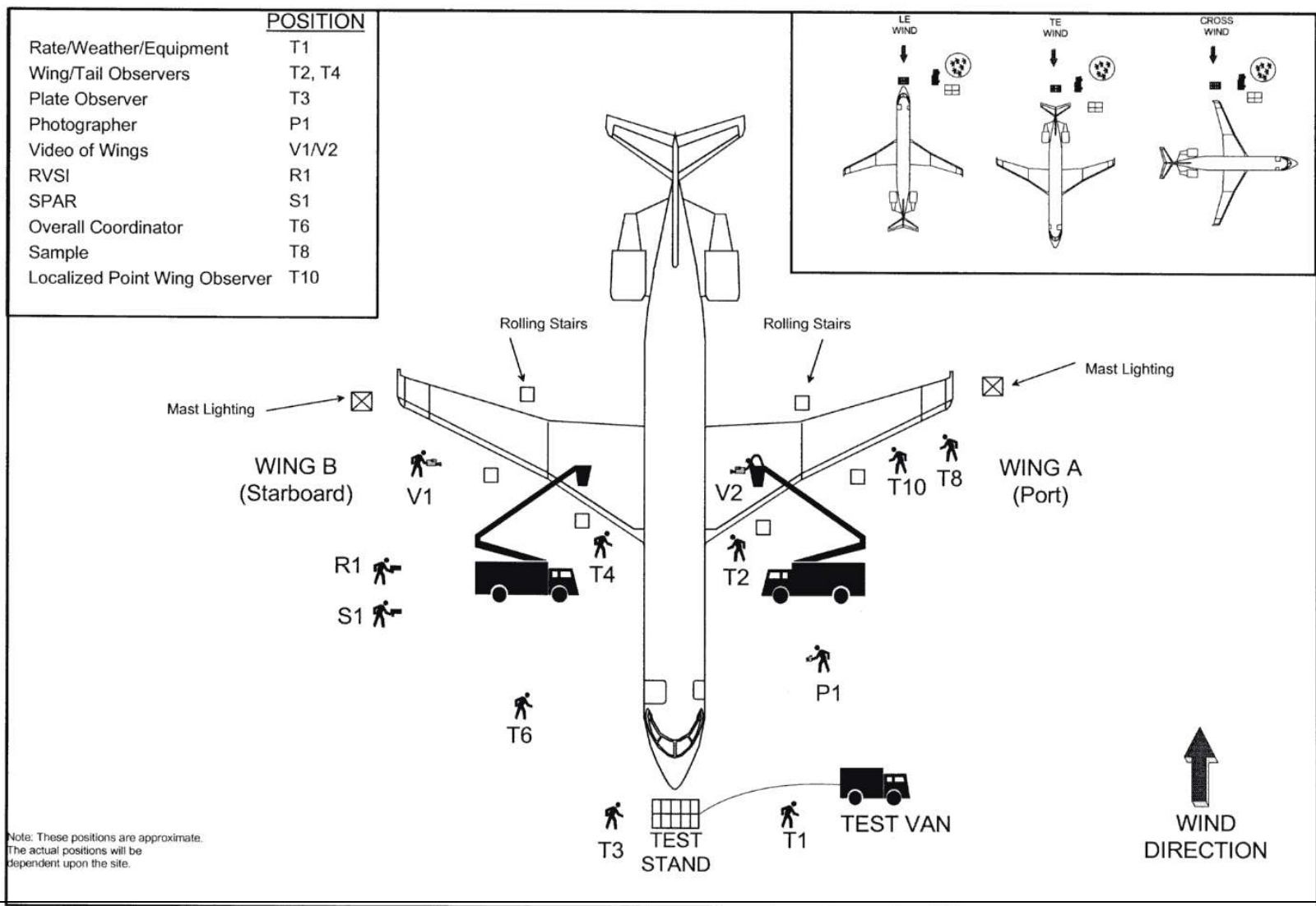



FIGURE B-6a  
**GENERAL FORM (EVERY TEST)**  
**(TO BE FILLED IN BY PLATE/WING COORDINATOR)**

DATE: \_\_\_\_\_

AIRCRAFT TYPE: ATR-42 F-100 B-737 RJ DHC-8

RUN #: \_\_\_\_\_

WING: PORT (A) STARBOARD (B)

DIRECTION OF AIRCRAFT: \_\_\_\_\_ DEGREES

DRAW DIRECTION OF WIND WRT WING:



1st FLUID APPLICATION

Actual Start Time: \_\_\_\_\_ am / pm

Actual End Time: \_\_\_\_\_ am / pm

Amount of Fluid Sprayed: \_\_\_\_\_ L / gal

Type of Fluid: \_\_\_\_\_

2nd FLUID APPLICATION

Actual Start Time: \_\_\_\_\_ am / pm

Actual End Time: \_\_\_\_\_ am / pm

Amount of Fluid Sprayed: \_\_\_\_\_ L / gal

Type of Fluid: \_\_\_\_\_

End of Test Time: \_\_\_\_\_ (hr:min:ss) am/pm

COMMENTS: \_\_\_\_\_  
\_\_\_\_\_  
\_\_\_\_\_  
\_\_\_\_\_  
\_\_\_\_\_  
\_\_\_\_\_  
\_\_\_\_\_  
\_\_\_\_\_

MEASUREMENTS BY: \_\_\_\_\_

HAND WRITTEN BY: \_\_\_\_\_



**GENERAL FORM (ONCE PER SESSION)  
(TO BE FILLED IN BY OVERALL COORDINATOR)**

AIRPORT: YUL YYZ YOW

AIRCRAFT TYPE: ATR-42 F-100 B-737 RJ DHC-8

EXACT PAD LOCATION OF TEST: \_\_\_\_\_

AIRLINE: \_\_\_\_\_

DATE: \_\_\_\_\_

FIN #: \_\_\_\_\_

APPROX. AIR TEMPERATURE: \_\_\_\_\_ °C

FUEL LOAD: \_\_\_\_\_ LB / KG

<i>TYPE I FLUID APPLICATION</i>	<i>TYPE IV FLUID APPLICATION</i>
TYPE I FLUID TEMP: _____ °C Type I Truck #: _____ Type I Fluid Nozzle Type: _____ Sample collected: Y / N	TYPE IV FLUID TEMP: _____ °C Type IV Truck #: _____ Type IV Fluid Nozzle Type: _____ Sample collected: Y / N

**TEMPERATURE MEASUREMENTS**

<b>ENTER FLUID TYPE:</b>						
<b>TIME</b>	<b>TEMPERATURE AT LOCATION (°C)</b>					
(min)	M6/7	M5/6	L4/5	M4/5	M3/4	M2/3
Before <sup>1</sup> ( )						

(1) Actual Time Before Fluid Application

COMMENTS: \_\_\_\_\_  
 \_\_\_\_\_  
 \_\_\_\_\_  
 \_\_\_\_\_  
 \_\_\_\_\_  
 \_\_\_\_\_  
 \_\_\_\_\_  
 \_\_\_\_\_

MEASUREMENTS BY: \_\_\_\_\_

HAND WRITTEN BY: \_\_\_\_\_

DE/ANTI-ICING FORM FOR AIRCRAFT WING

DATE: _____	RUN NUMBER: _____
-------------	-------------------

FAILURES CALLED BY: \_\_\_\_\_

COMMENTS: \_\_\_\_\_

HANDWRITTEN BY: \_\_\_\_\_

\_\_\_\_\_

ASSISTED BY: \_\_\_\_\_

\_\_\_\_\_

**DRAW FAILURE CONTOURS (hr:min) ACCORDING TO THE PROCEDURE**

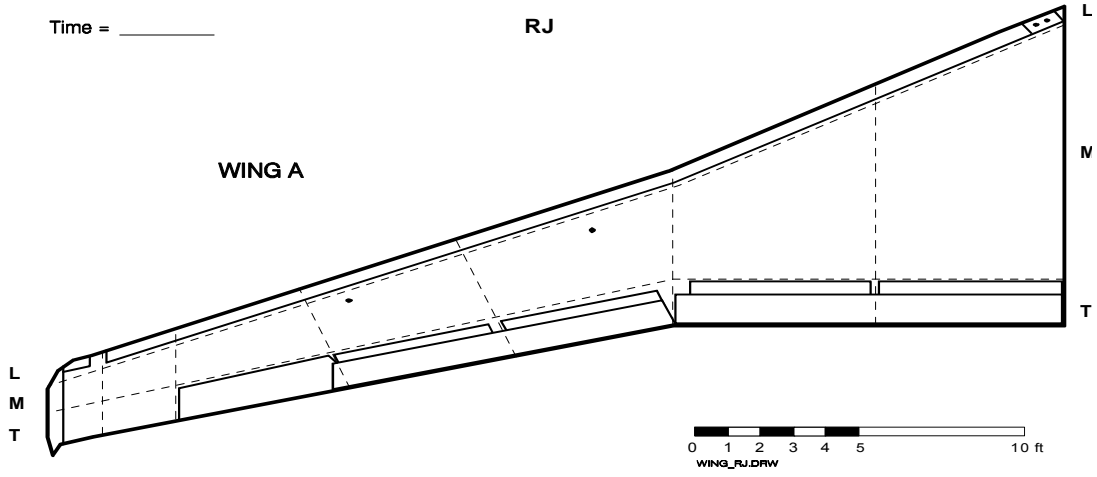
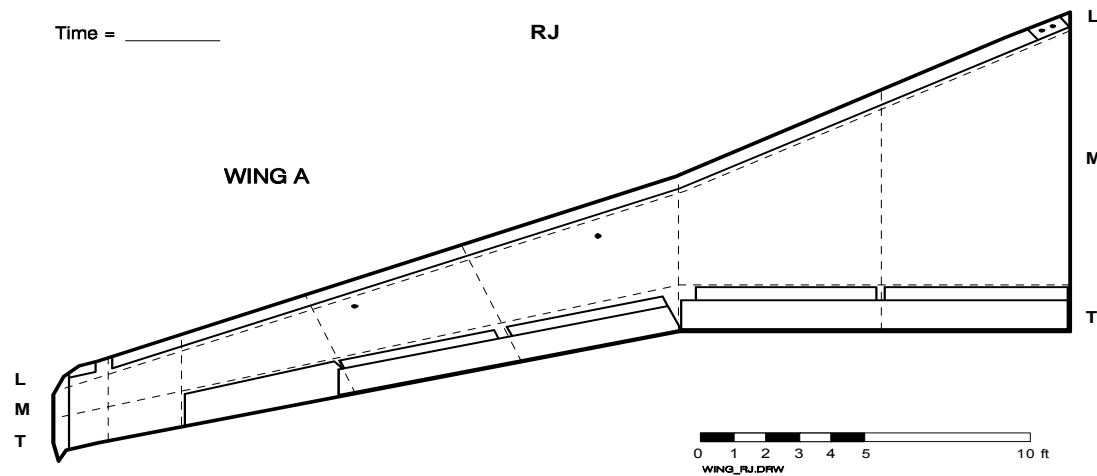
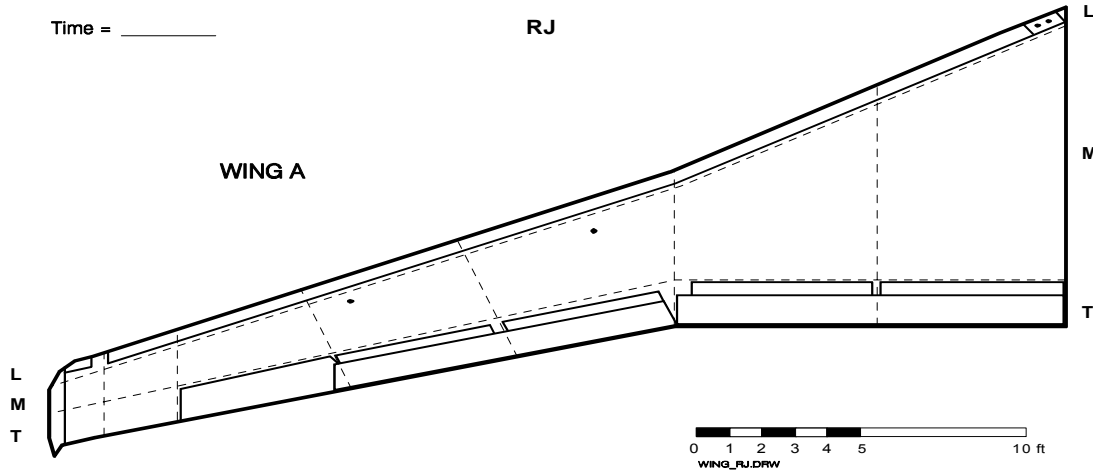

Note: To Compare to Flat Plate testing, subtract "Time of Initial Fluid Application".

DE/ANTI-ICING FORM FOR AIRCRAFT WING

REMEMBER TO SYNCHRONIZE TIME

VERSION 4.0

Winter 97/98

DATE: _____	RUN NUMBER: _____
-------------	-------------------

FAILURES CALLED BY: \_\_\_\_\_

COMMENTS: \_\_\_\_\_

HANDWRITTEN BY: \_\_\_\_\_

\_\_\_\_\_

ASSISTED BY: \_\_\_\_\_

\_\_\_\_\_

**DRAW FAILURE CONTOURS (hr:min) ACCORDING TO THE PROCEDURE**

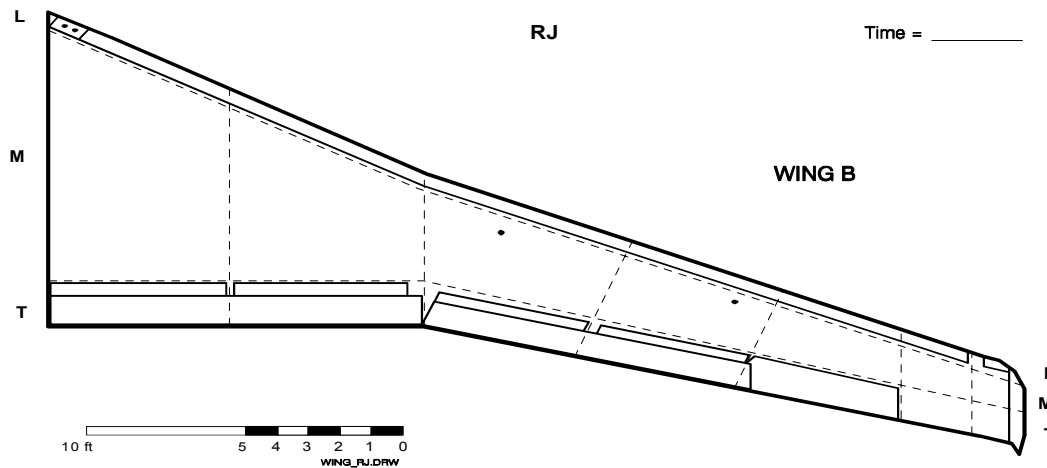
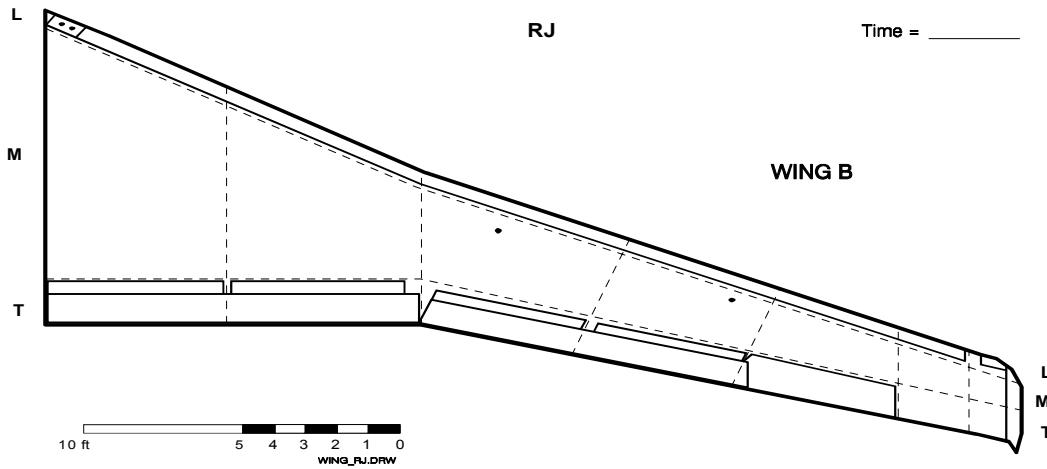
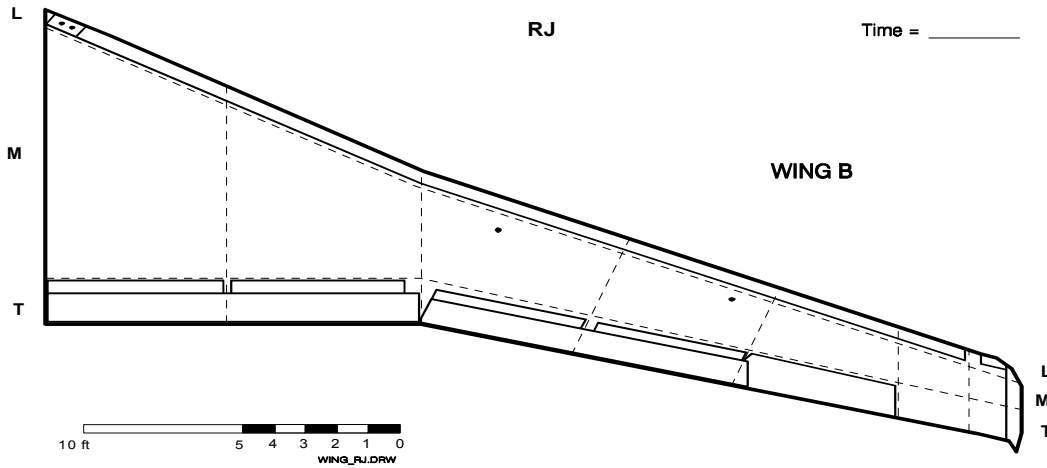

Note: To Compare to Flat Plate testing, subtract "Time of Initial Fluid Application".

FIGURE B-8  
**LOCALIZED FORM FOR AIRCRAFT WING**

REMEMBER TO SYNCHRONIZE TIME

VERSION 4.0

Winter 1999/2000

<b>DATE:</b> _____	<b>RUN NUMBER:</b> _____
--------------------	--------------------------

**FAILURES CALLED BY:** \_\_\_\_\_

**COMMENTS:** \_\_\_\_\_

**HANDWRITTEN BY:** \_\_\_\_\_

**ASSISTED BY:** \_\_\_\_\_

**DRAW FAILURE CONTOURS (hr:min) AT PREDETERMINED LOCATIONS**

Time = \_\_\_\_\_

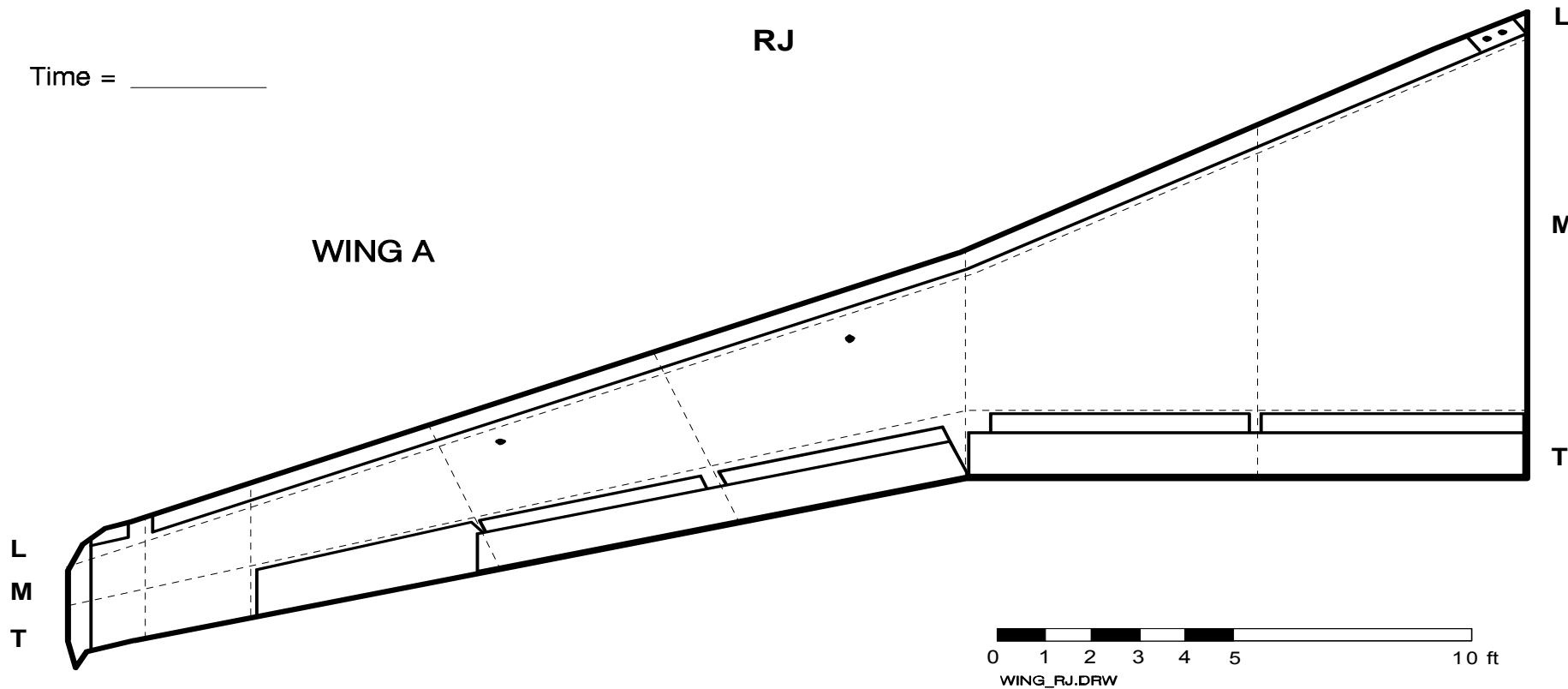

FIGURE B-9  
**FLUID THICKNESS ON AIRCRAFT**

AIRPORT: YUL YYZ YOW

AIRCRAFT TYPE: ATR 42

RJ

DATE: \_\_\_\_\_

WING: PORT (A)

STARBOARD (B)

RUN #: \_\_\_\_\_

DRAW DIRECTION OF WIND WRT WING:



DIRECTION OF AIRCRAFT: \_\_\_\_\_ DEGREES

<i>1st FLUID APPLICATION</i>	
Actual Start Time: _____ am / pm	Actual End Time: _____ am / pm
Amount of Fluid Sprayed: _____ L / gal	Type of Fluid: _____
<i>2nd FLUID APPLICATION</i>	
Actual Start Time: _____ am / pm	Actual End Time: _____ am / pm
Amount of Fluid Sprayed: _____ L / gal	Type of Fluid: _____

Location	Time	Gauge	Time	Gauge	Time	Gauge	Time	Gauge	Time	Gauge
1										
2										
3										
4										
5										
6										
7										
8										
9										
10										

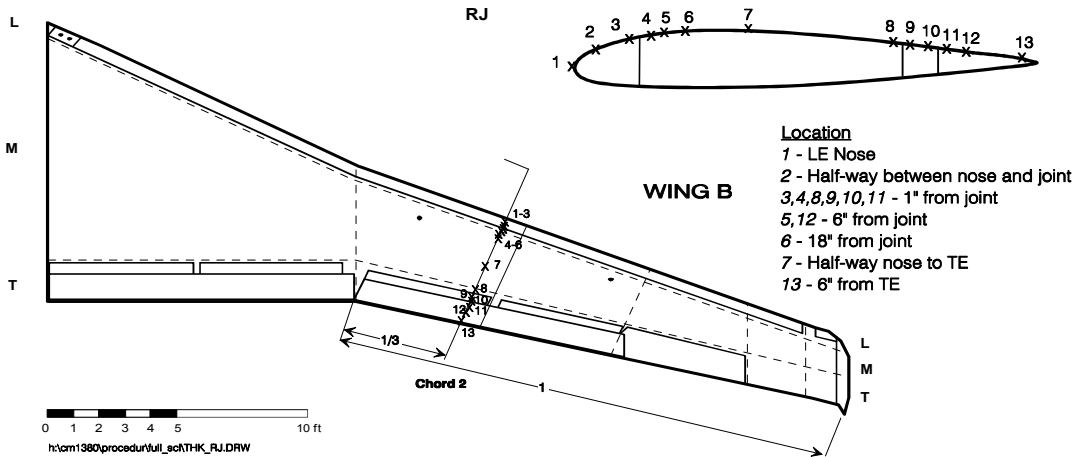

COMMENTS: \_\_\_\_\_  
 \_\_\_\_\_  
 \_\_\_\_\_  
 \_\_\_\_\_  
 \_\_\_\_\_

MEASUREMENTS BY: \_\_\_\_\_

HAND WRITTEN BY: \_\_\_\_\_



FIGURE B-11a  
**DE/ANTI-ICING FORM FOR TEST WING**

REMEMBER TO SYNCHRONIZE TIME

VERSION 4.0

Winter 1999/2000

DATE: _____	RUN NUMBER: _____
-------------	-------------------

FAILURES CALLED BY: \_\_\_\_\_

COMMENTS: \_\_\_\_\_

HANDWRITTEN BY: \_\_\_\_\_

\_\_\_\_\_

ASSISTED BY: \_\_\_\_\_

\_\_\_\_\_

DRAW FAILURE CONTOURS (hr:min) ACCORDING TO THE PROCEDURE

**RJ - Tail**

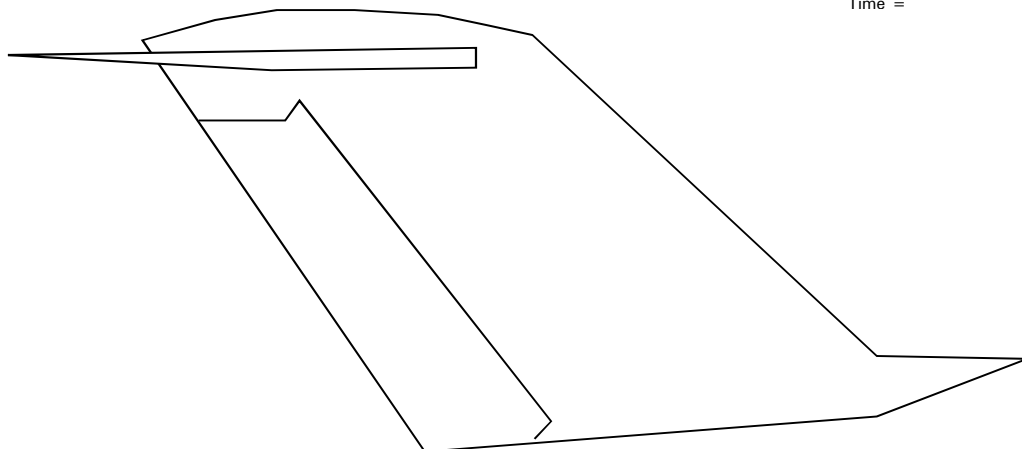
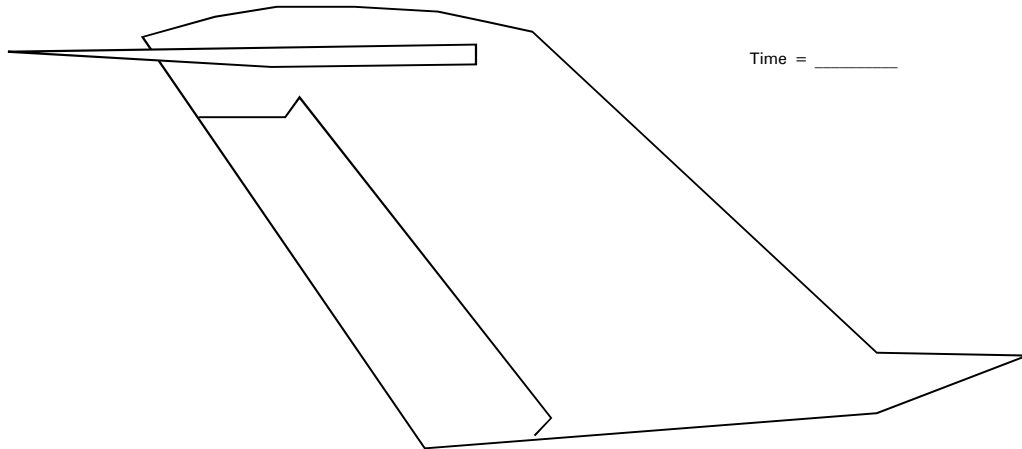
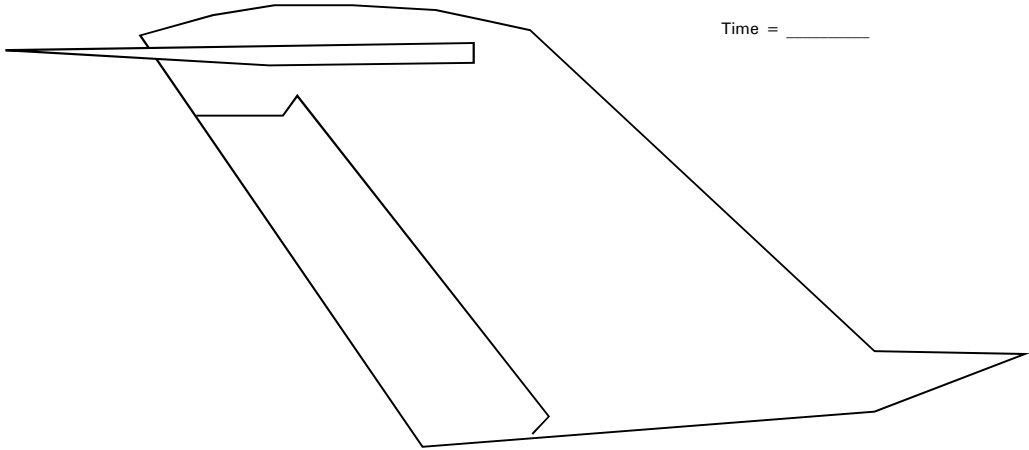

FIGURE B-11b  
DE/ANTI-ICING FORM FOR TEST WING

REMEMBER TO SYNCHRONIZE TIME

VERSION 4.0

Winter 1999/2000

DATE: _____	RUN NUMBER: _____
-------------	-------------------

FAILURES CALLED BY: \_\_\_\_\_

COMMENTS: \_\_\_\_\_

HANDWRITTEN BY: \_\_\_\_\_

\_\_\_\_\_

ASSISTED BY: \_\_\_\_\_

\_\_\_\_\_

DRAW FAILURE CONTOURS (hr.min) ACCORDING TO THE PROCEDURE

RJ - Tail

Time = \_\_\_\_\_

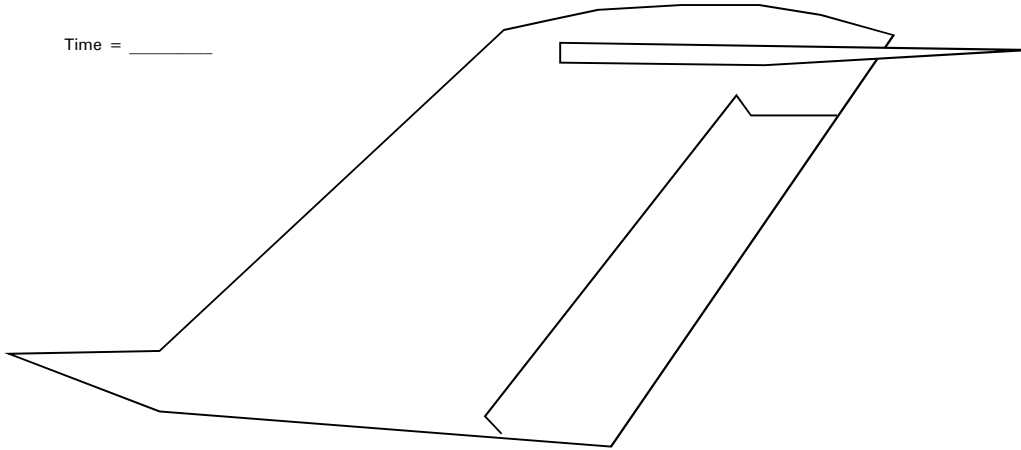

Time = \_\_\_\_\_

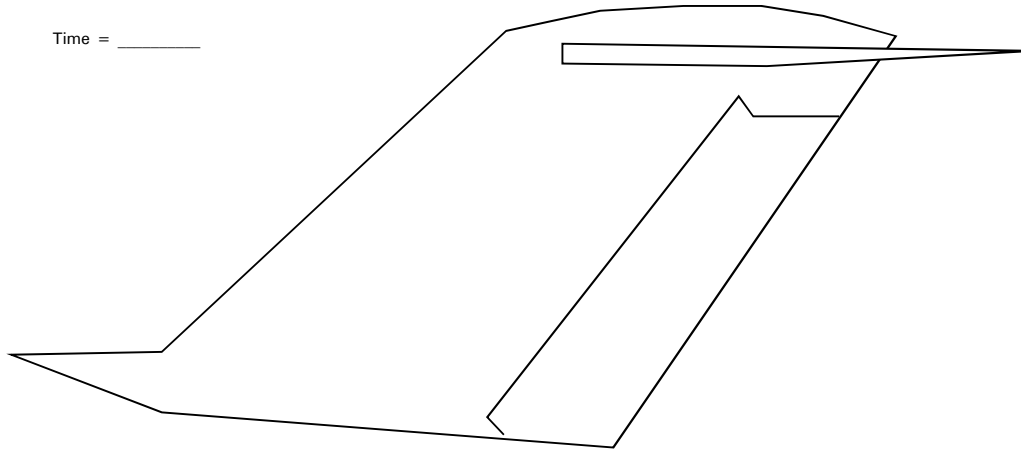

Time = \_\_\_\_\_

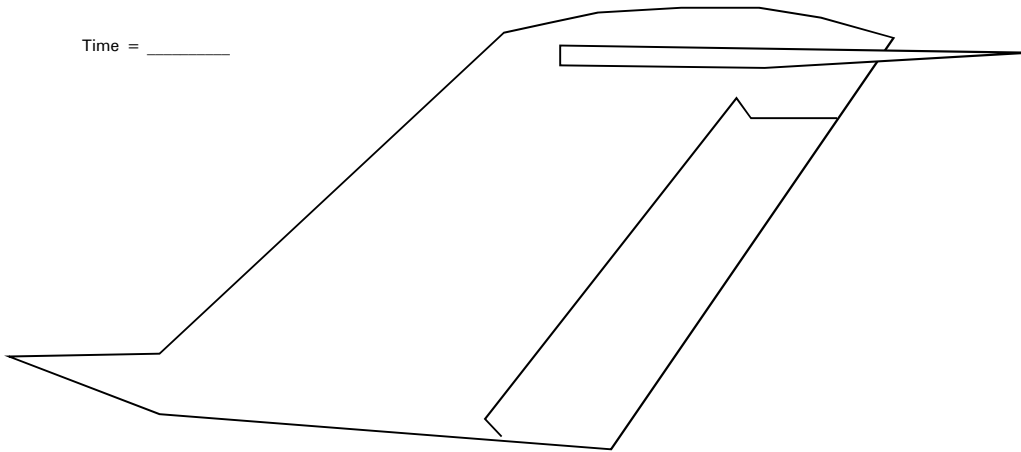
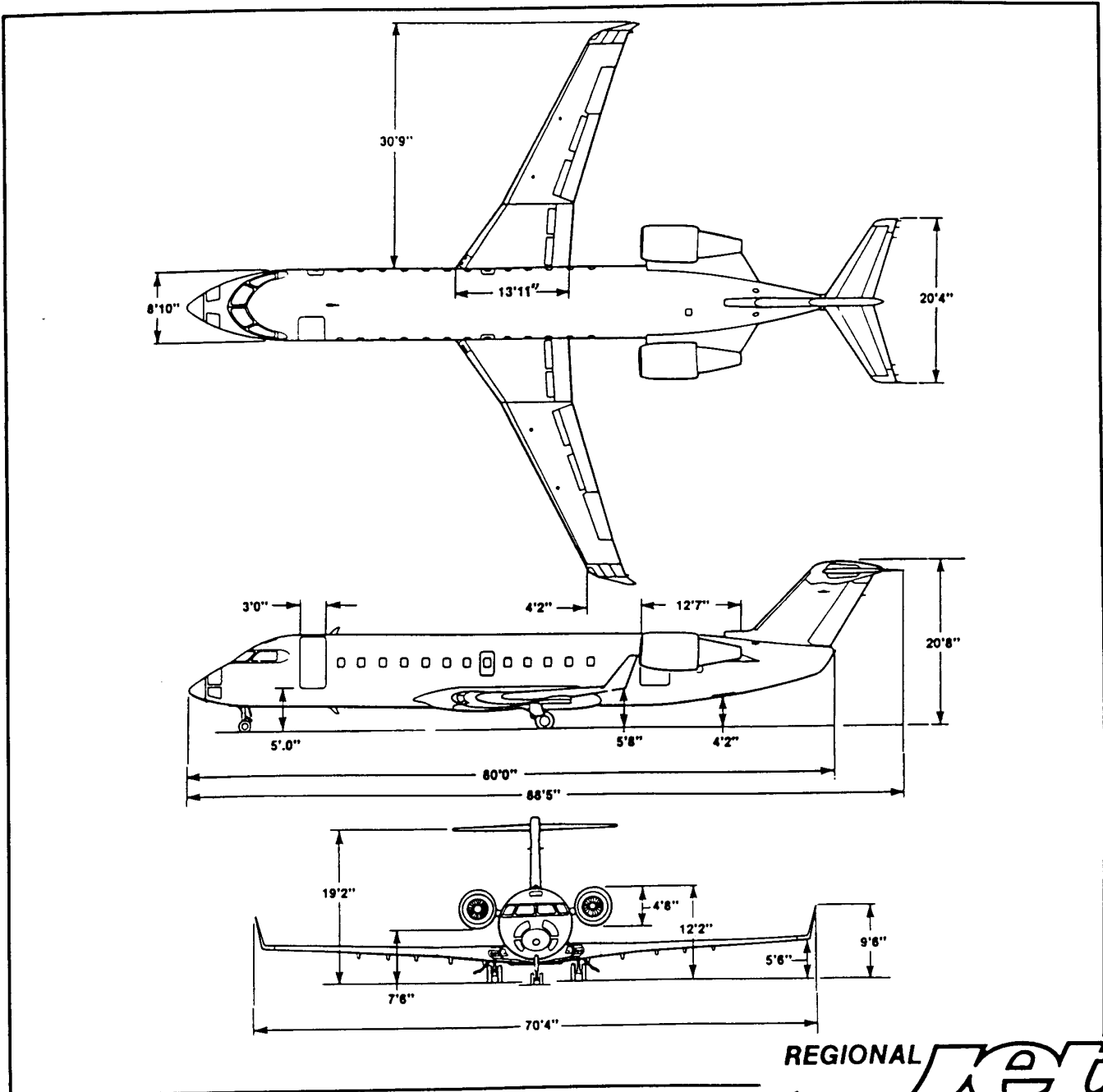







Figure B-12  
**THREE VIEW DRAWING**  
**Canadair RJ**



Litho Canada

All data presented in this document are strictly based on preliminary estimates.  
 Canadair does not make or intend to make any commitment, representation, or warranties whatsoever.  
 All data subject to change without prior notice by Canadair.

**APPENDIX C**

**WING FAILURE DIAGRAMS  
JANUARY 26, 2000**



FIGURE 4  
DE/ANTI-ICING FORM FOR AIRCRAFT WING

REMEMBER TO SYNCHRONIZE TIME VERSION 4.0 Wing 8784

DATE: 26/01/2000 RUN NUMBER: 1

FAILURES CALLED BY: N.H.N COMMENTS: \_\_\_\_\_

HANDWRITTEN BY: \_\_\_\_\_ COMMENTS: Sensor failed at 2:06

ASSISTED BY: \_\_\_\_\_

2

**DRAW FAILURE CONTOURS (hr:min) ACCORDING TO THE PROCEDURE**

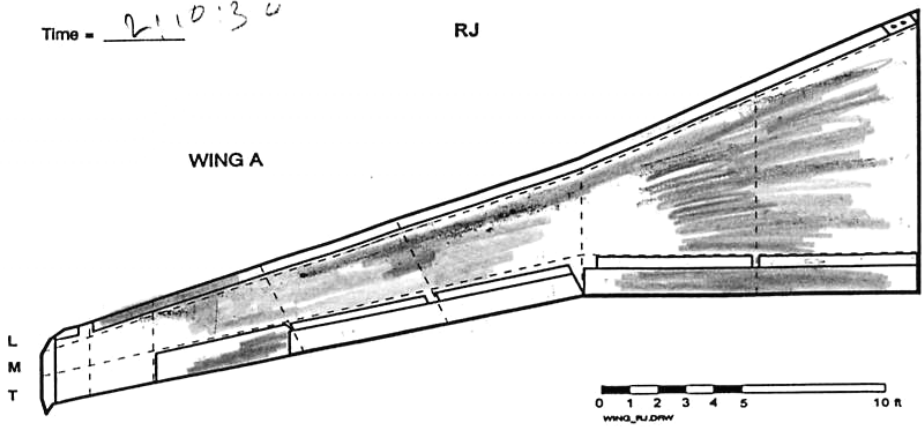
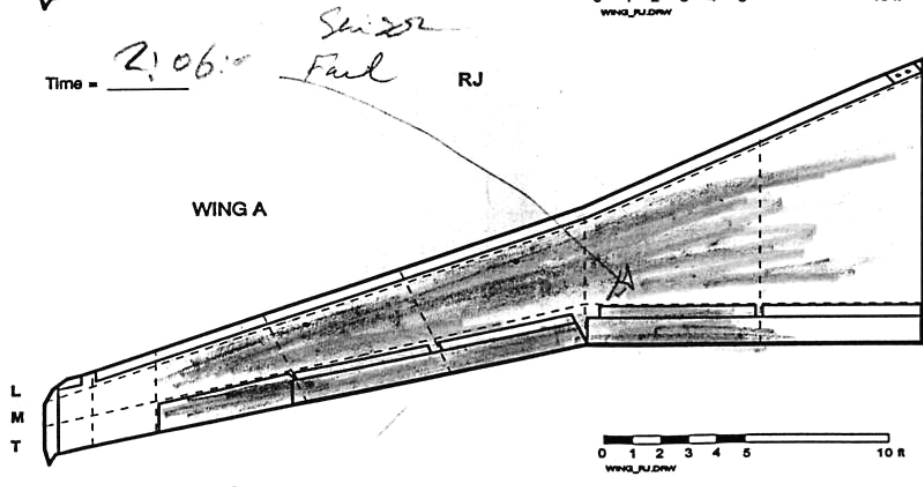
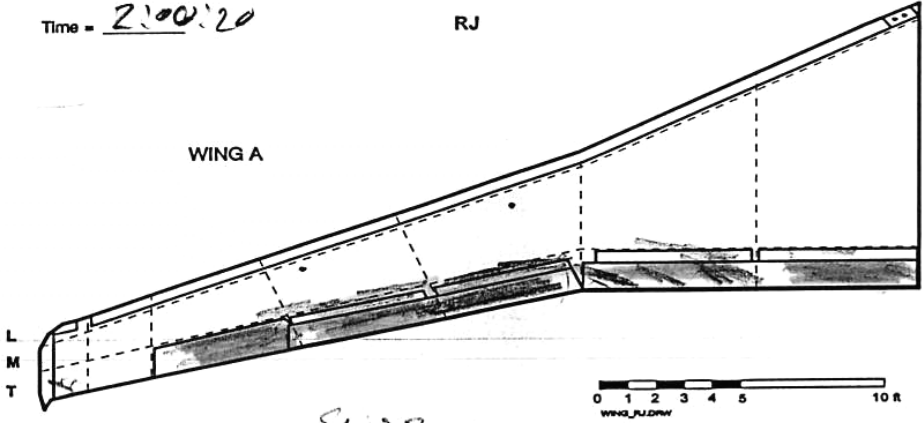

Note: To Compare to Flat Plate testing, subtract "Time of Initial Fluid Application".

FIGURE 4  
DE/ANTI-ICING FORM FOR AIRCRAFT WING

REMEMBER TO SYNCHRONIZE TIME

DATE: JAN 26 / 00	RUN NUMBER: 2	VERSION 4.0	Writer 9796
-------------------	---------------	-------------	-------------

FAILURES CALLED BY: M. CHAPVT

HANDWRITTEN BY: M. CHAPVT

ASSISTED BY: \_\_\_\_\_

COMMENTS: 900 kg of fuel onboard

DRAW FAILURE CONTOURS (hr:min) ACCORDING TO THE PROCEDURE

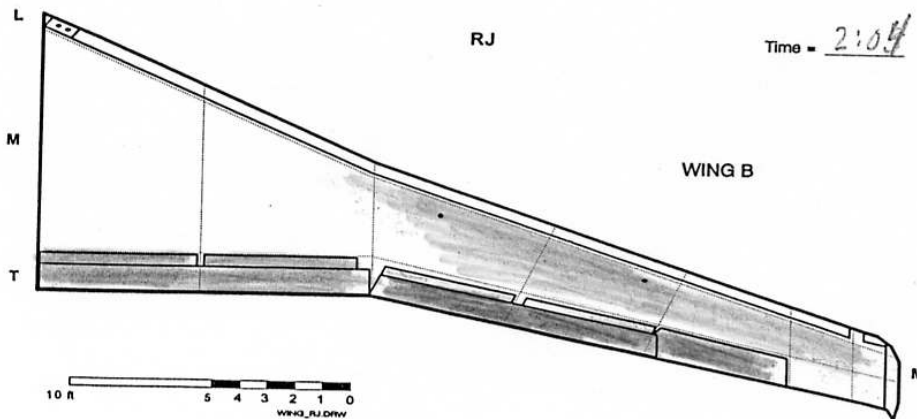
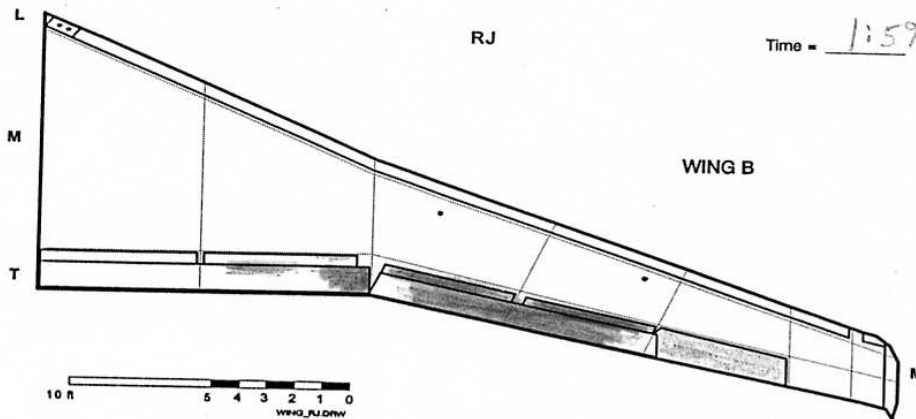
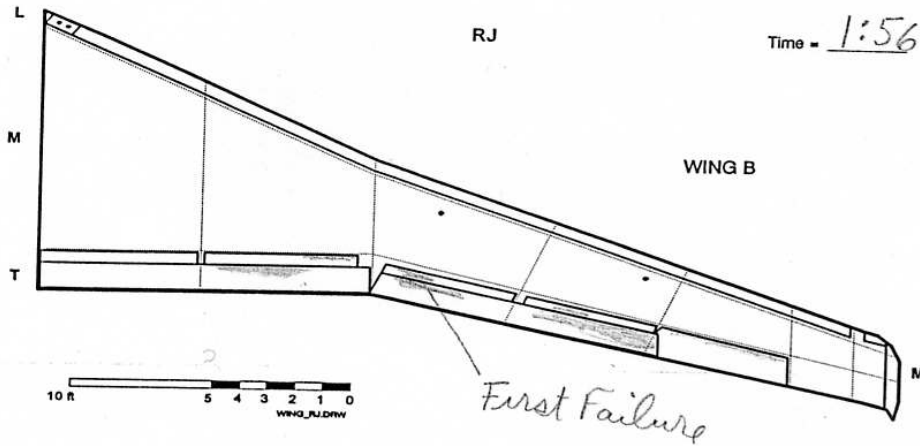

Note: To Compare to Flat Plate testing, subtract "Time of Initial Fluid Application".

File:cm1589\procedures\full scale\Diagram of RJ Wing B  
At Wing B Printed: 11/01/00 9:59 AM

FIGURE 4  
DE/ANTI-ICING FORM FOR AIRCRAFT WING

REMEMBER TO SYNCHRONIZE TIME

DATE: JAN 26 / 00 RUN NUMBER: 2 VERSION 4.0 Wter 0796

FAILURES CALLED BY: M. CHAPUT COMMENTS: \_\_\_\_\_

HANDWRITTEN BY: \_\_\_\_\_

ASSISTED BY: \_\_\_\_\_

DRAW FAILURE CONTOURS (hr:min) ACCORDING TO THE PROCEDURE

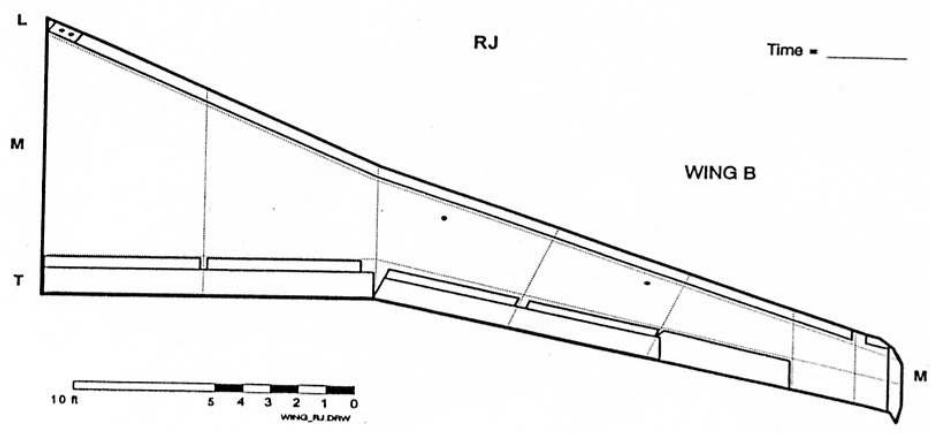
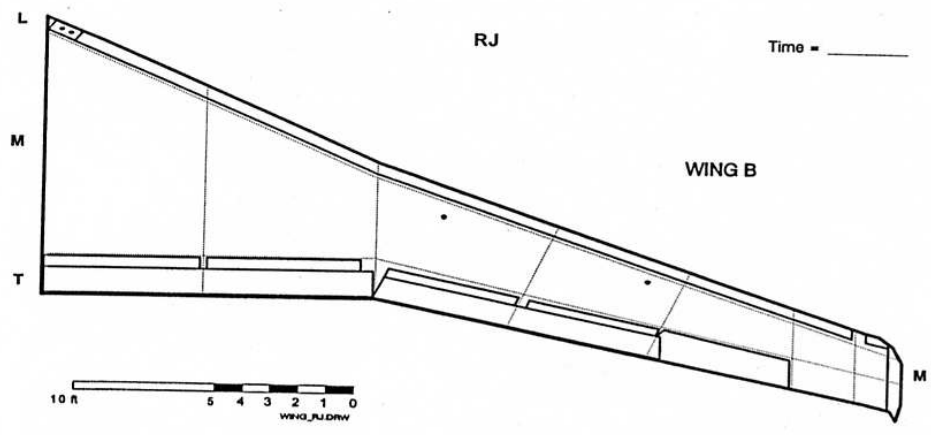
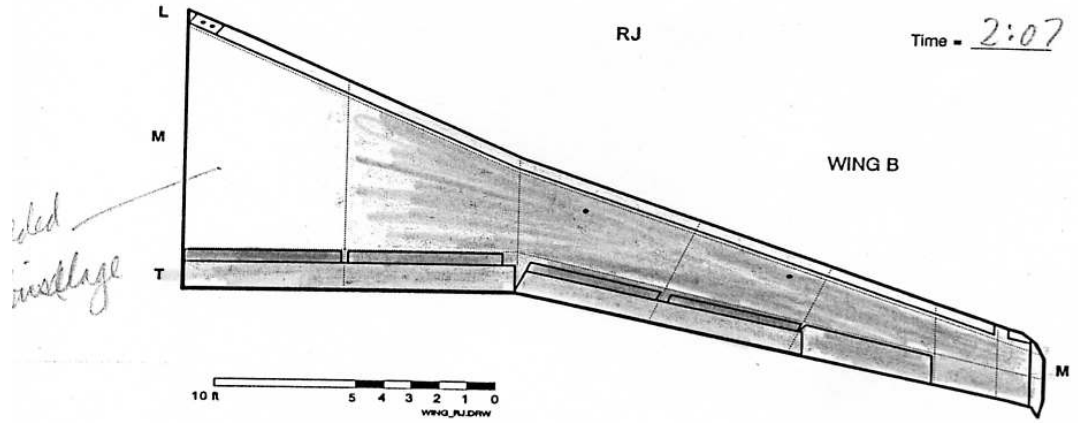

Note: To Compare to Flat Plate testing, subtract "Time of Initial Fluid Application".



FIGURE 5  
LOCALIZED FORM FOR AIRCRAFT WING

REMEMBER TO SYNCHRONIZE TIME

VERSION 4.0

Winter 1999/2000

DATE: JAN 26 / 00 RUN NUMBER: 2

FAILURES CALLED BY: M. CHAPVT

COMMENTS: \_\_\_\_\_

HANDWRITTEN BY: \_\_\_\_\_

ASSISTED BY: \_\_\_\_\_

DRAW FAILURE CONTOURS (hr:min) AT PREDETERMINED LOCATIONS

Time = \_\_\_\_\_

RJ

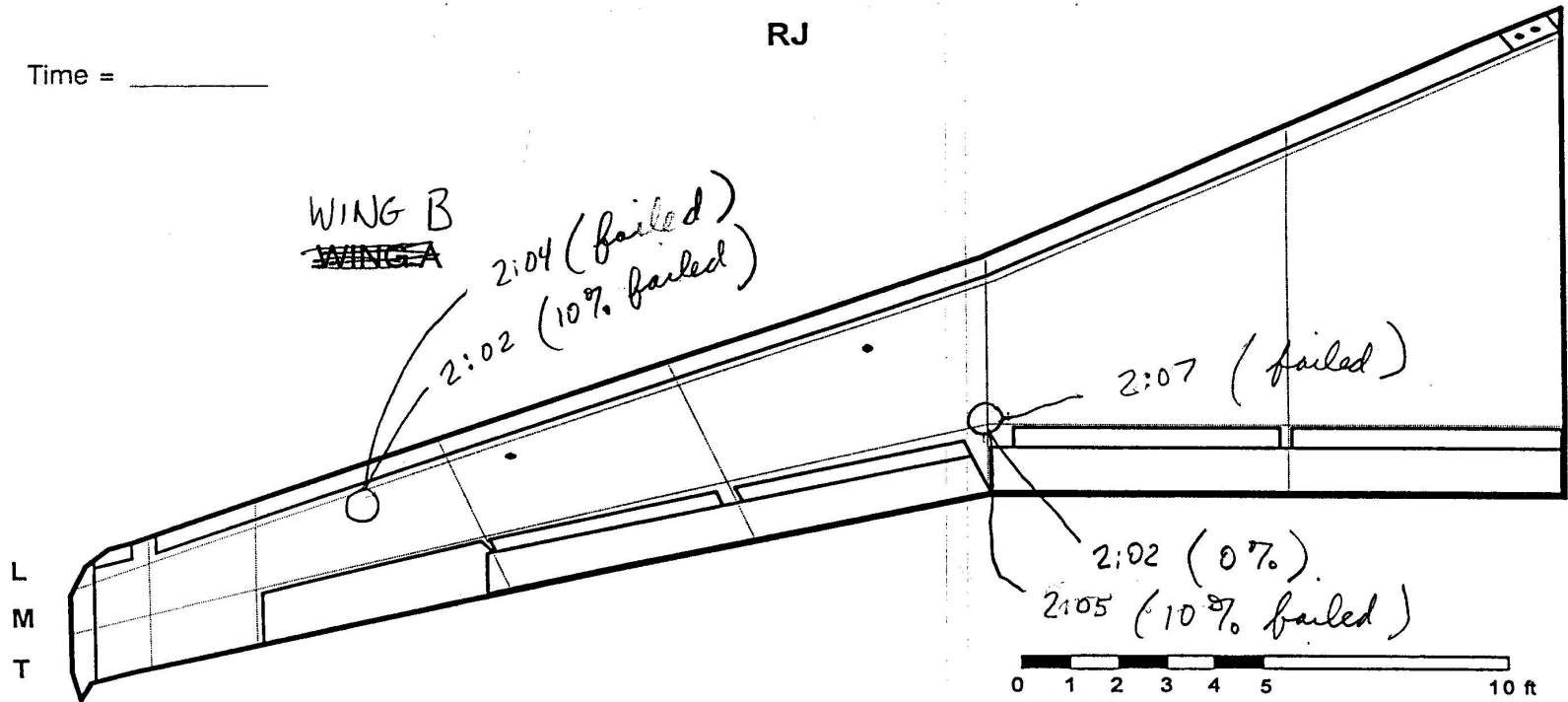

0 1 2 3 4 5 10 ft  
WING\_RJ.DRW

C-5

FIGURE 4  
DE/ANTI-ICING FORM FOR AIRCRAFT WING

V2

REMEMBER TO SYNCHRONIZE TIME

DATE: 26/01/200	RUN NUMBER: (3)	VERSION 4.0	Wdr1878
-----------------	-----------------	-------------	---------

FAILURES CALLED BY: M. HACON

HANDWRITTEN BY: /

ASSISTED BY: /

COMMENTS: \_\_\_\_\_

DRAW FAILURE CONTOURS (hr:min) ACCORDING TO THE PROCEDURE

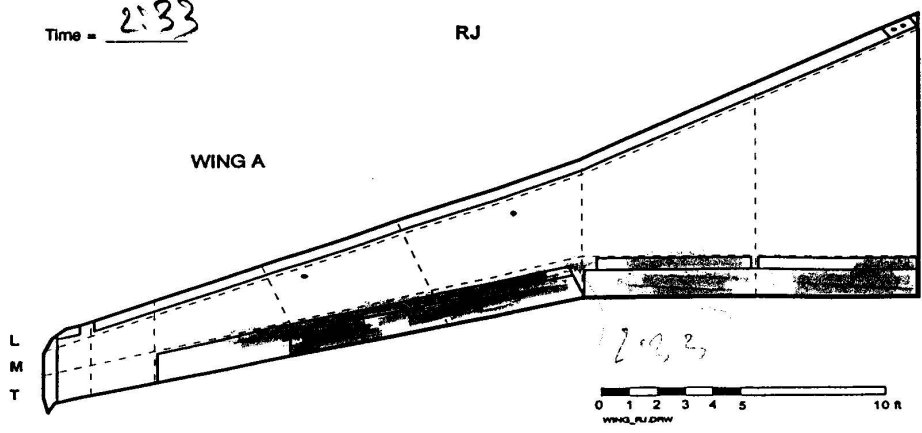
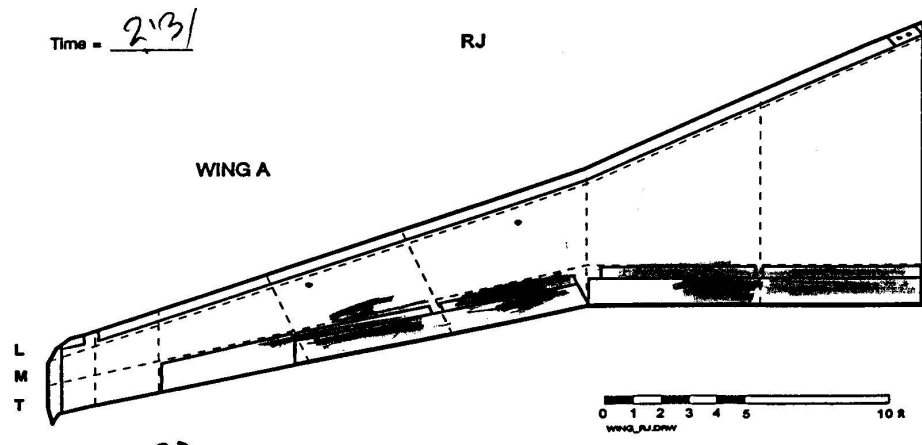
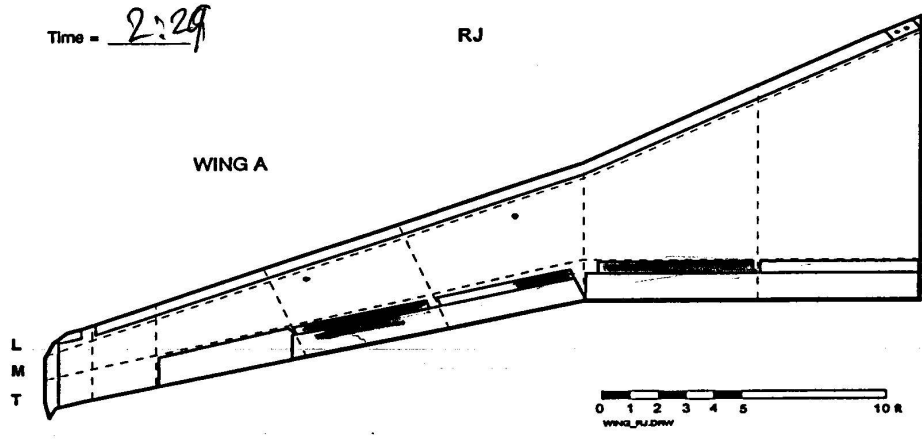

Note: To Compare to Flat Plate testing, subtract "Time of Initial Fluid Application".

FIGURE 4  
DE/ANTI-ICING FORM FOR AIRCRAFT WING

(24)

REMEMBER TO SYNCHRONIZE TIME

DATE: 26/01/2000	RUN NUMBER: (3)	VERSION 4.0	Wing 9708
------------------	-----------------	-------------	-----------

FAILURES CALLED BY: M. HANNA

HANDWRITTEN BY: \_\_\_\_\_

ASSISTED BY: \_\_\_\_\_

COMMENTS: \_\_\_\_\_

DRAW FAILURE CONTOURS (hr:min) ACCORDING TO THE PROCEDURE

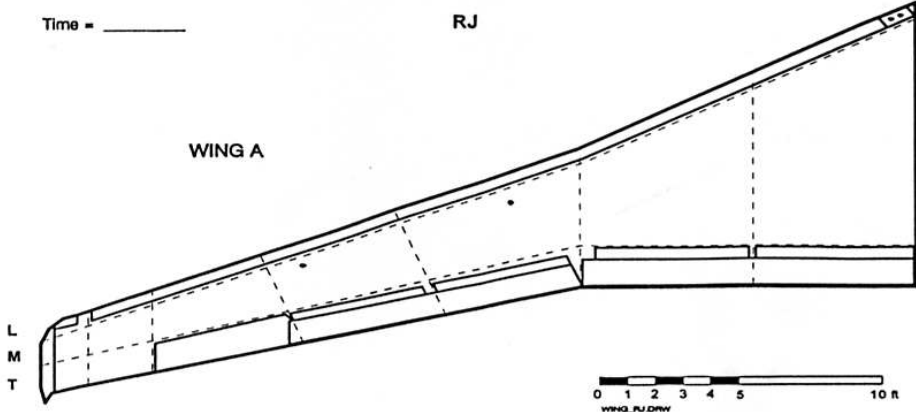
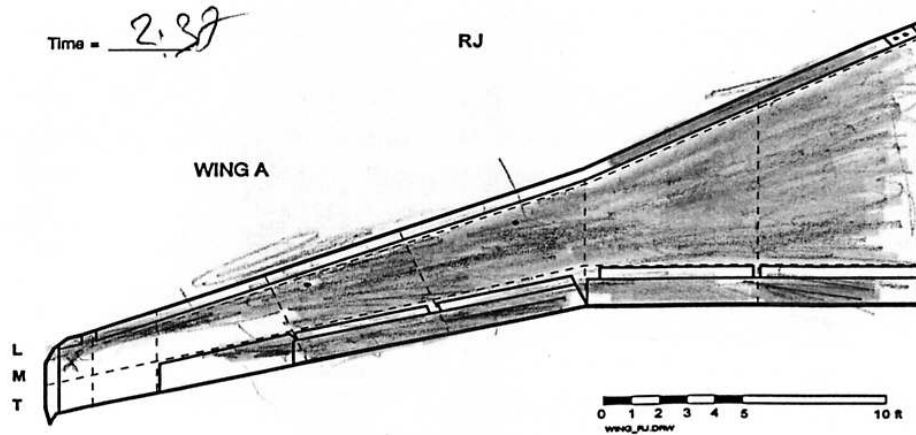
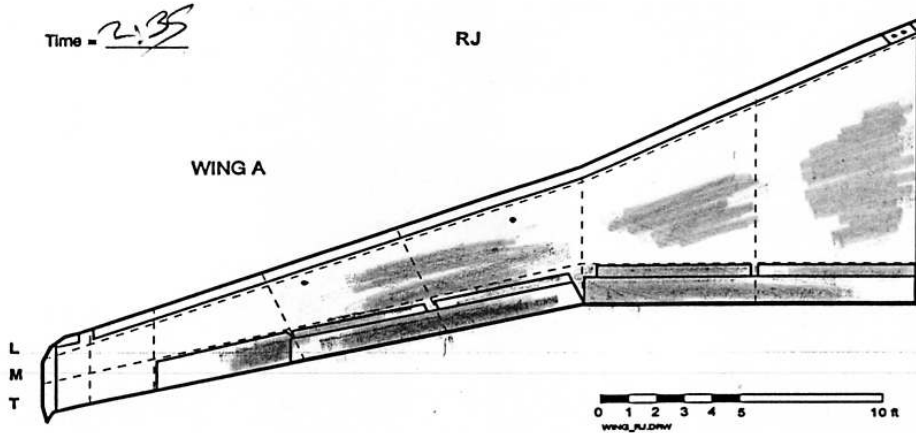

Note: To Compare to Flat Plate testing, subtract "Time of Initial Fluid Application".

FIGURE 4  
DE/ANTI-ICING FORM FOR AIRCRAFT WING

REMEMBER TO SYNCHRONIZE TIME	VERSION 4.0	Wing 8798
DATE: <u>JAN 26/00</u>	RUN NUMBER: <u>4</u>	

FAILURES CALLED BY: M. CHAPUT COMMENT: \_\_\_\_\_

HANDWRITTEN BY: \_\_\_\_\_

ASSISTED BY: \_\_\_\_\_

**DRAW FAILURE CONTOURS (fr:mIn) ACCORDING TO THE PROCEDURE**

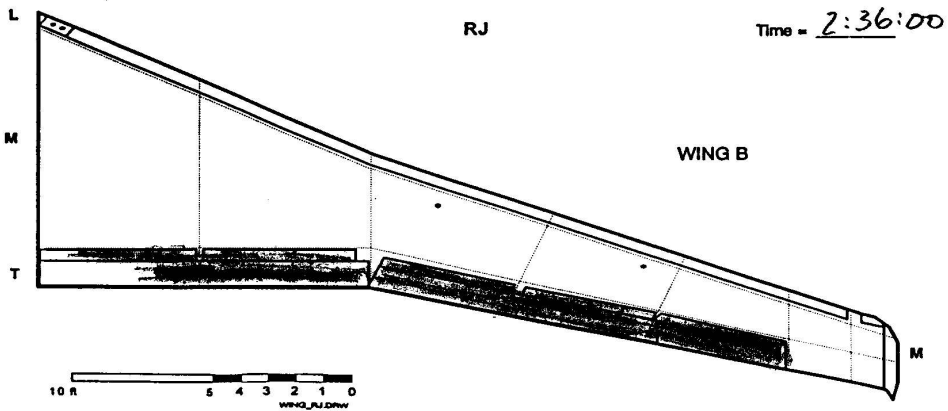
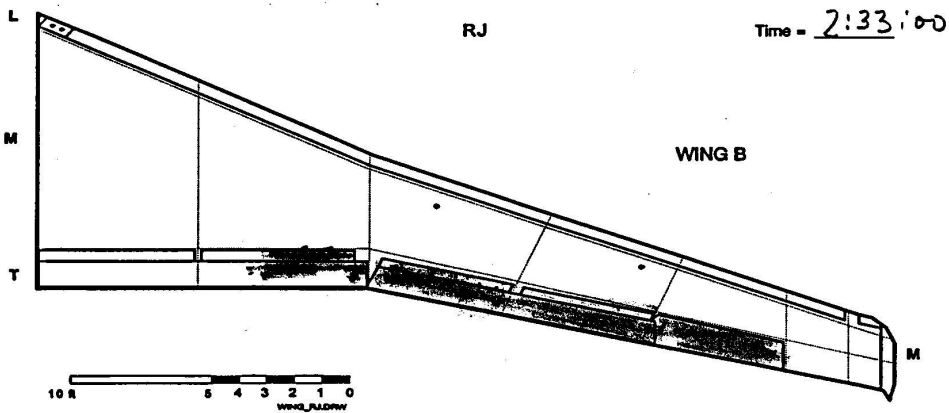
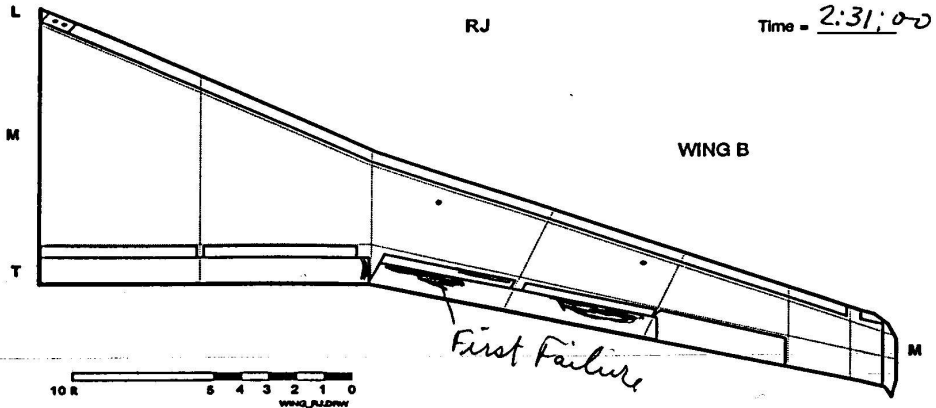

Note: To Compare to Flat Plate testing, subtract "Time of Initial Fluid Application".

**FIGURE 4  
DE/ANTI-ICING FORM FOR AIRCRAFT WING**

REMEMBER TO SWITCH ON IZ TIME	VERSION 4.0	Writer: 9798
DATE: <u>JAN 26 / 00</u>	RUN NUMBER: <u>4</u>	

FAILURES CALLED BY: M. CHAPUT      COMMENT: \_\_\_\_\_

HANDWRITTEN BY: \_\_\_\_\_

ASSISTED BY: \_\_\_\_\_

DRAW FAILURE CONTOURS (hr:min) ACCORDING TO THE PROCEDURE

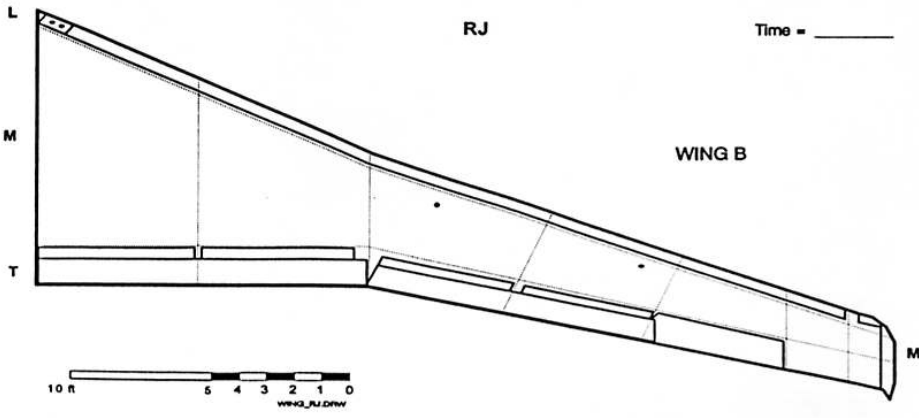
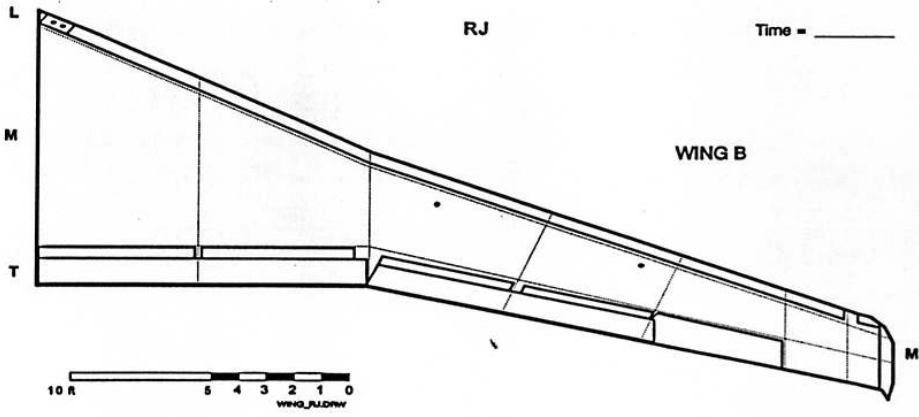
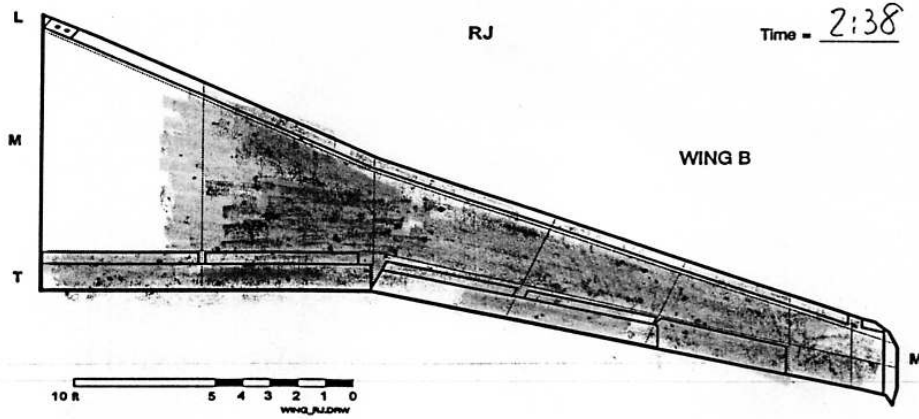

Note: To Compare to Flat Plate testing, subtract "Time of Initial Fluid Application".

FIGURE 5  
LOCALIZED FORM FOR AIRCRAFT WING

REMEMBER TO SYNCHRONIZE TIME

VERSION 4.0

Winter 1999/2000

DATE: JAN 26 / 00 RUN NUMBER: ~~3~~ 4

FAILURES CALLED BY: M. CHAPUT

COMMENTS: \_\_\_\_\_

HANDWRITTEN BY: \_\_\_\_\_

ASSISTED BY: \_\_\_\_\_

DRAW FAILURE CONTOURS (hr:min) AT PREDETERMINED LOCATIONS

RJ

Time = \_\_\_\_\_

C-10

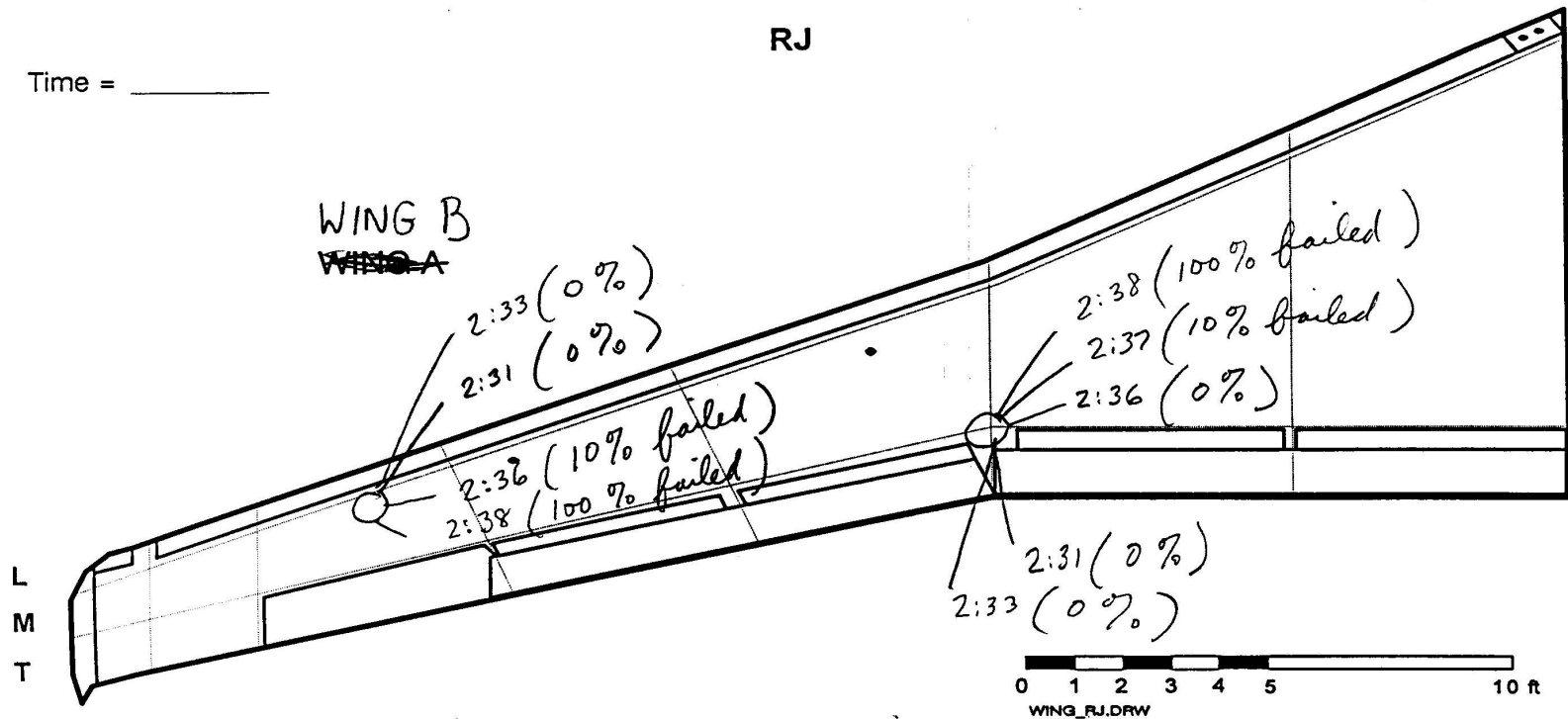

FIGURE 4  
DE/ANTI-ICING FORM FOR AIRCRAFT WING

1/2

REMEMBER TO SYNCHRONIZE TIME

VERSION 4.0    Wdr:19708

DATE: 26/01/2000      RUN NUMBER: 5

FAILURES CALLED BY: M. HANCOCK      COMMENTS: \_\_\_\_\_

HANDWRITTEN BY: \_\_\_\_\_

ASSISTED BY: \_\_\_\_\_

DRAW FAILURE CONTOURS (hr:min) ACCORDING TO THE PROCEDURE

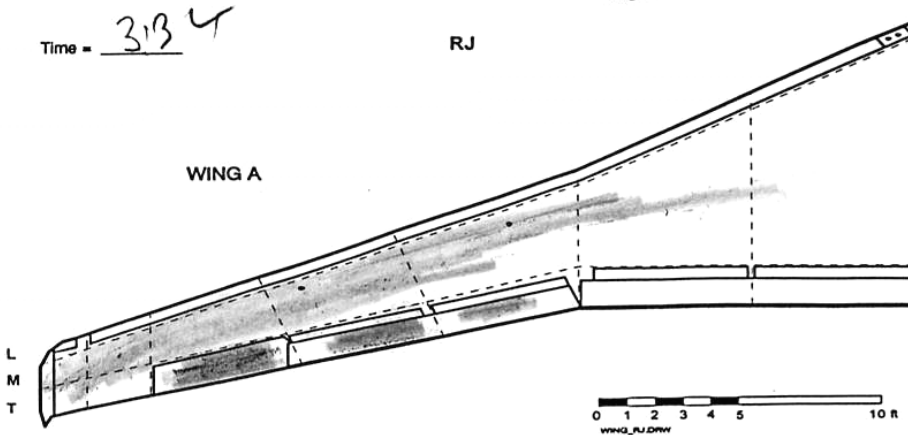
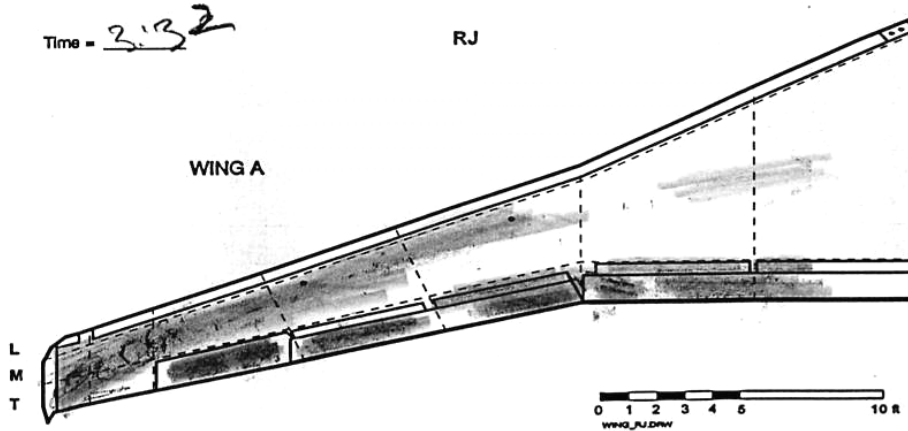
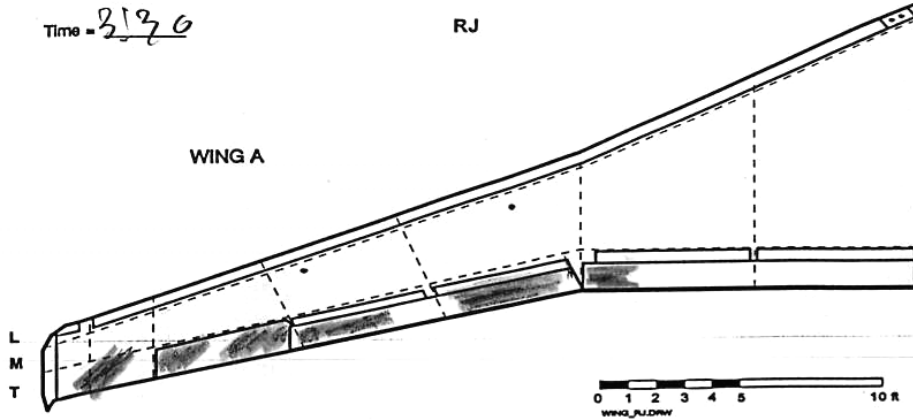

Note: To Compare to Flat Plate testing, subtract "Time of Initial Fluid Application".

File:1\cm1500\procedure\W4-scale\Diagram of RJ Wing A  
At: Wing A    Printed: 11/01/00, 9:50 AM



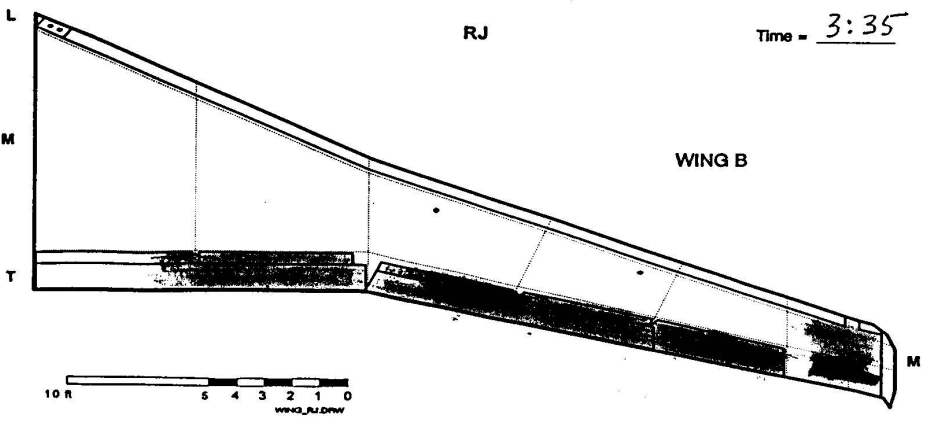
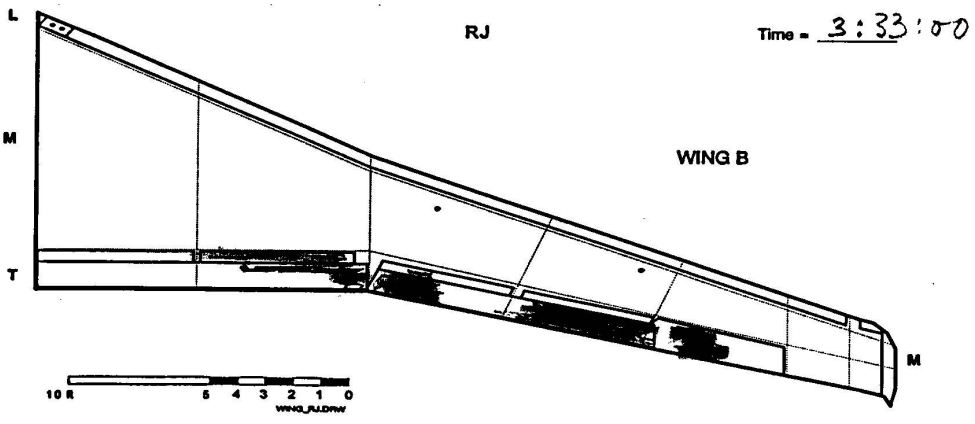
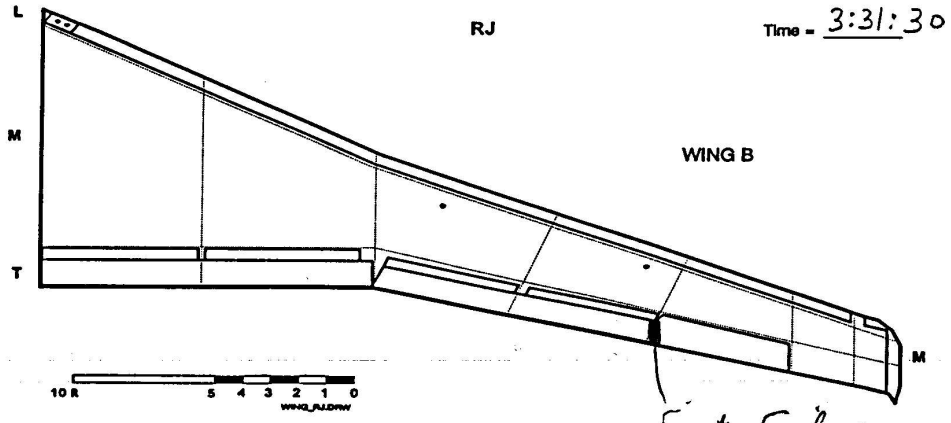

**FIGURE 4  
DE/ANTI-ICING FORM FOR AIRCRAFT WING**

REMEMBER TO SYNCHRONIZE TIME	VERSION 4.0	Wing#700
DATE: <b>JAN 26 / 00</b>	RUN NUMBER: <b>6</b>	

FAILURES CALLED BY: M. CHAPUT      COMMENTS: \_\_\_\_\_  
 HANDWRITTEN BY: \_\_\_\_\_  
 ASSISTED BY: \_\_\_\_\_

**DRAW FAILURE CONTOURS (hr:min) ACCORDING TO THE PROCEDURE**



Note: To Compare to Flat Plate testing, subtract "Time of Initial Fluid Application".

**FIGURE 4  
DE/ANTI-ICING FORM FOR AIRCRAFT WING**

REMEMBER TO Synchronize TIME	VERSION 4.0	Writer 9706
DATE: <u>JAN 26 / 00</u>	RUN NUMBER: <u>6</u>	

FAILURES CALLED BY: M. CHAPUT      COMMENTS: \_\_\_\_\_

HANDWRITTEN BY: \_\_\_\_\_

ASSISTED BY: \_\_\_\_\_

**DRAW FAILURE CONTOURS (hr:min) ACCORDING TO THE PROCEDURE**

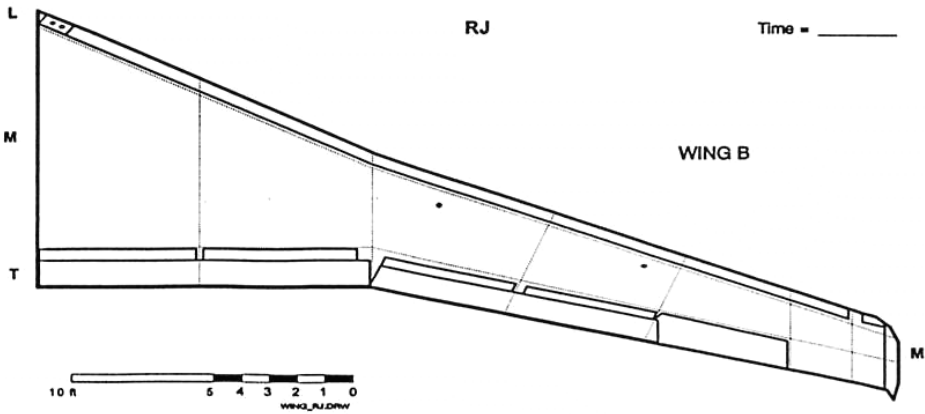
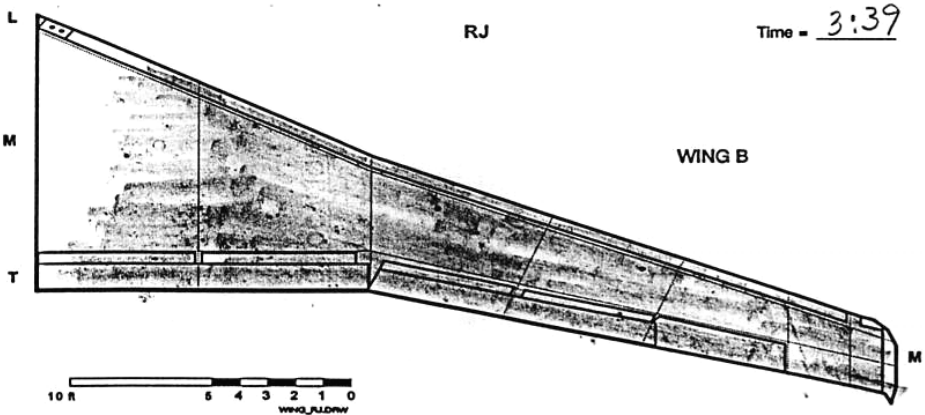
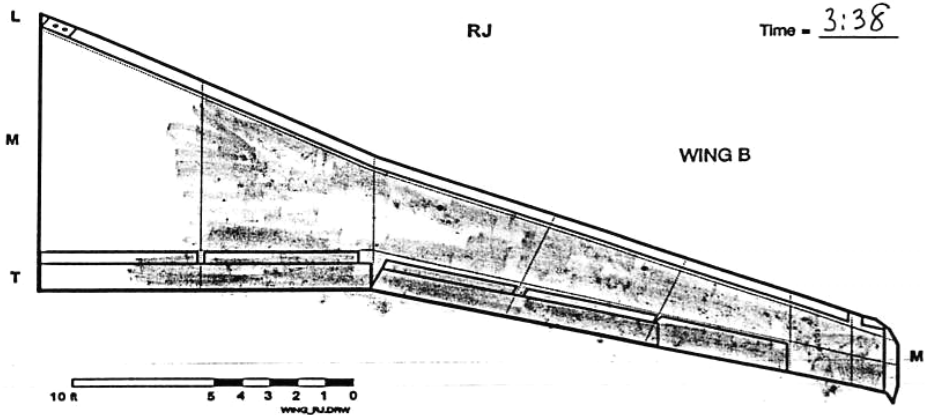

Note: To Compare to Flat Plate testing, subtract "Time of Initial Fluid Application".

FIGURE 5  
LOCALIZED FORM FOR AIRCRAFT WING

REMEMBER TO SYNCHRONIZE TIME

VERSION 4.0

Winter 1999/2000

DATE: JAN. 26/00 RUN NUMBER: 6

FAILURES CALLED BY: M. CHAPUT

COMMENTS: \_\_\_\_\_

HANDWRITTEN BY: \_\_\_\_\_

ASSISTED BY: \_\_\_\_\_

DRAW FAILURE CONTOURS (hr:min) AT PREDETERMINED LOCATIONS

Time = \_\_\_\_\_

RJ

C-15

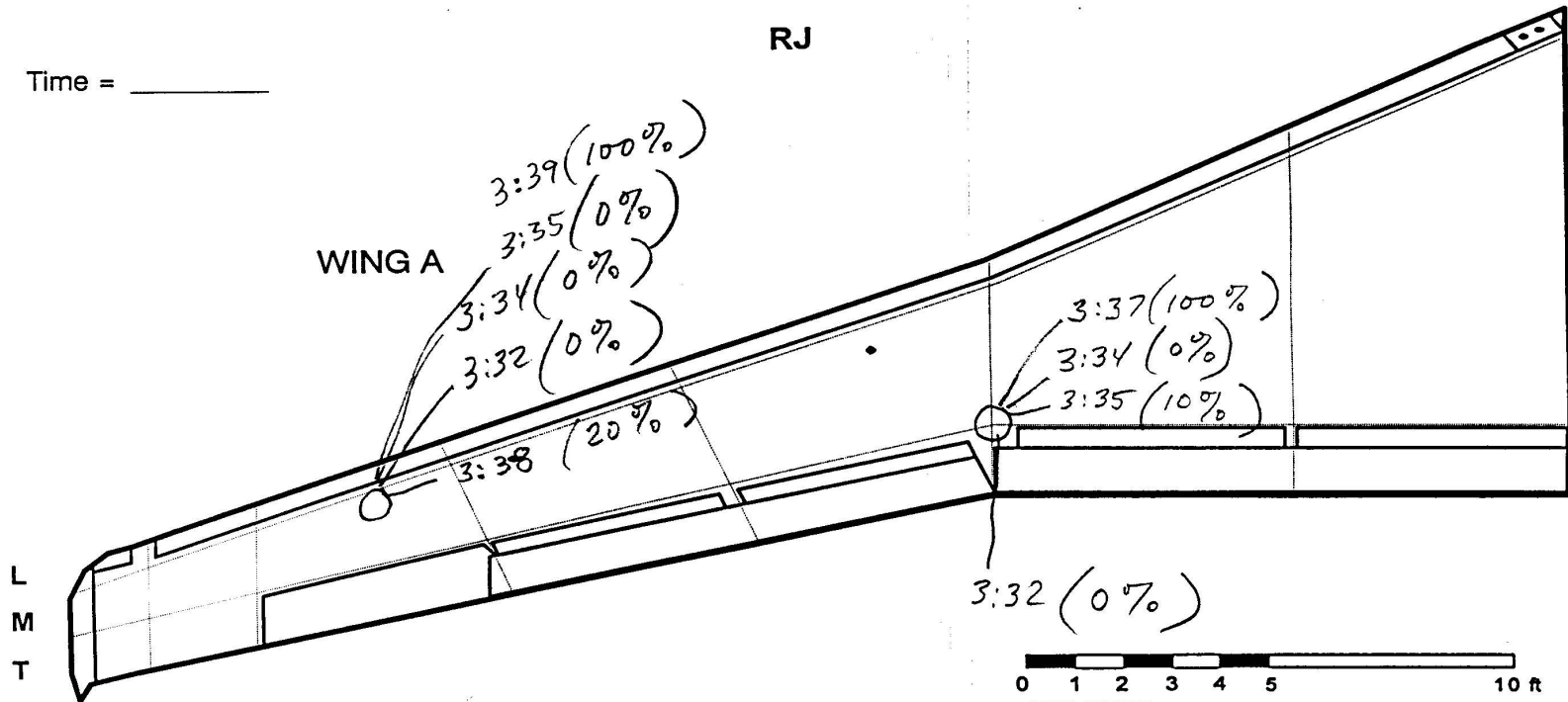

L  
M  
T

**FIGURE 4  
DE/ANTI-ICING FORM FOR AIRCRAFT WING**

REMEMBER TO SYNCHRONIZE TIME	VERSION 4.0	Water 8786
DATE: <u>26/01/2000</u>	RUN NUMBER: <u>7</u>	

FAILURES CALLED BY: _____	COMMENTS: _____
HANDWRITTEN BY: _____	_____
ASSISTED BY: _____	_____

**DRAW FAILURE CONTOURS (hr:min) ACCORDING TO THE PROCEDURE**

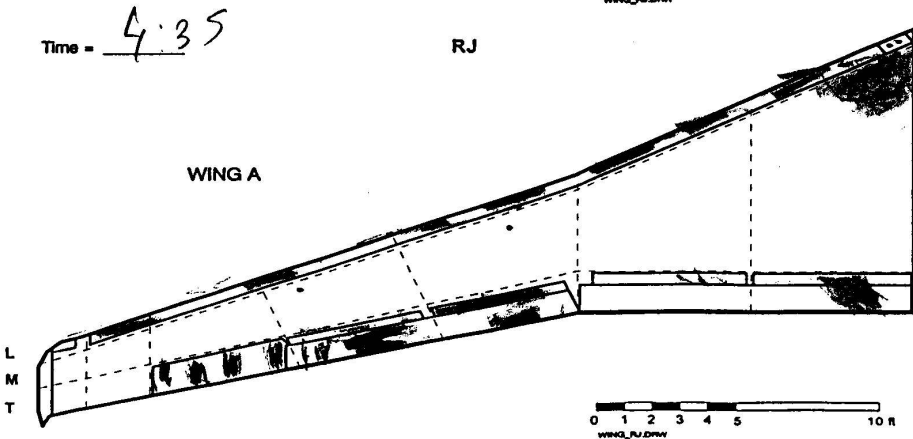
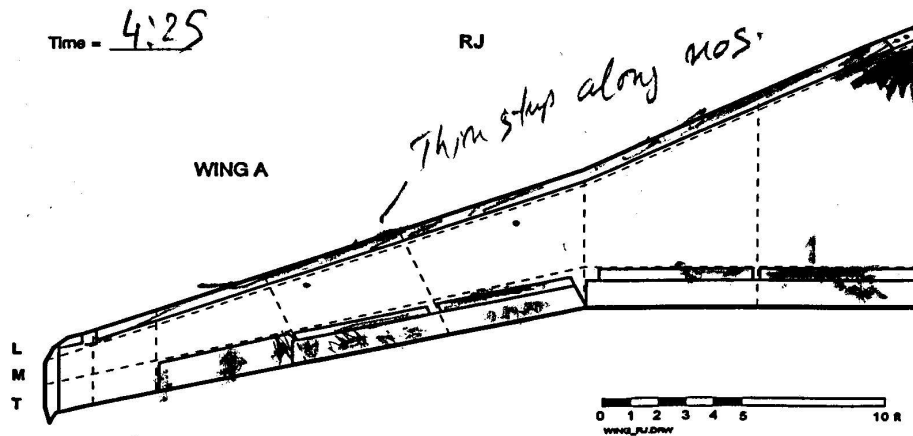
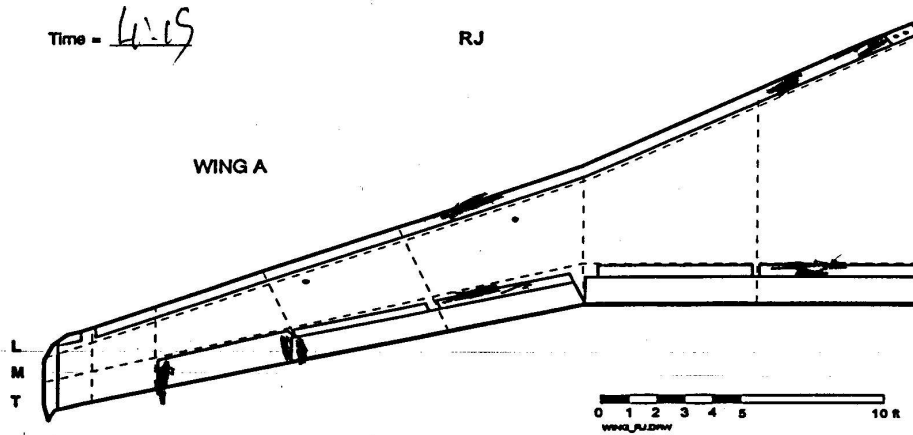

Note: To Compare to Flat Plate testing, subtract "Time of Initial Fluid Application".

**FIGURE 4  
DE/ANTI-ICING FORM FOR AIRCRAFT WING**

REMEMBER TO SYNCHRONIZE TIME	VERSION 4.0	Wing 8706
DATE: <b>JAN 26 / 00</b>	RUN NUMBER: <b>8</b>	

FAILURES CALLED BY: M. CHAPUT      COMMENT: \_\_\_\_\_

HANDWRITTEN BY: \_\_\_\_\_

ASSISTED BY: \_\_\_\_\_

**DRAW FAILURE CONTOURS (hr:min) ACCORDING TO THE PROCEDURE**

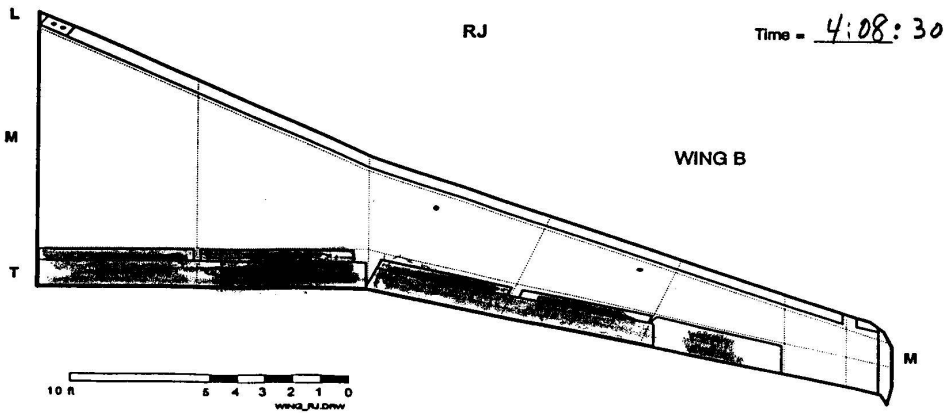
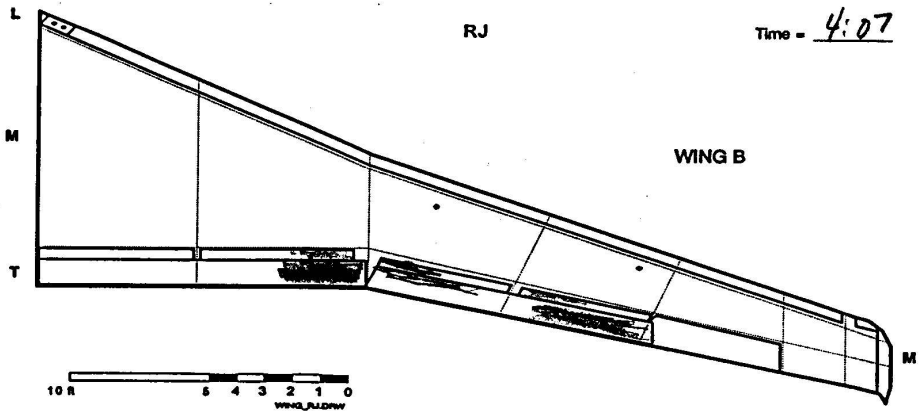
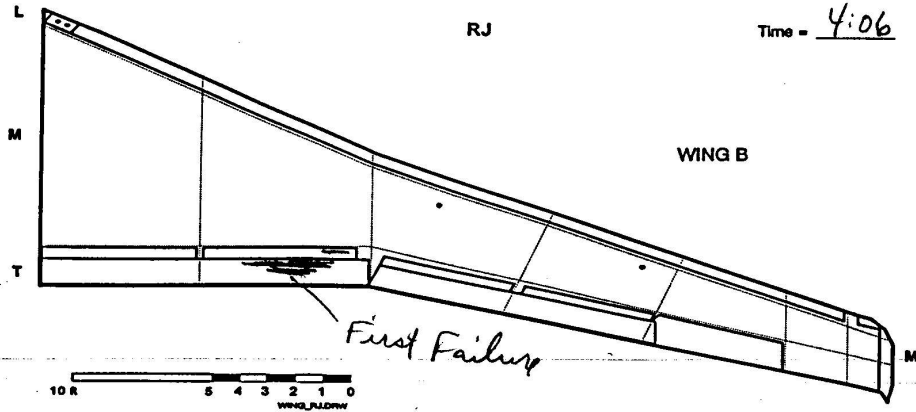

Note: To Compare to Flat Plate testing, subtract "Time of Initial Fluid Application".

**FIGURE 4  
DE/ANTI-ICING FORM FOR AIRCRAFT WING**

REMEMBER TO SYNCHRONIZE TIME VERSION 4.0    WING 8708

DATE: JAN 26 / 00      RUN NUMBER: 8

FAILURES CALLED BY: M. CHAPUT      COMMENTS: \_\_\_\_\_

HANDWRITTEN BY: \_\_\_\_\_

ASSISTED BY: \_\_\_\_\_

**DRAW FAILURE CONTOURS (hr:min) ACCORDING TO THE PROCEDURE**

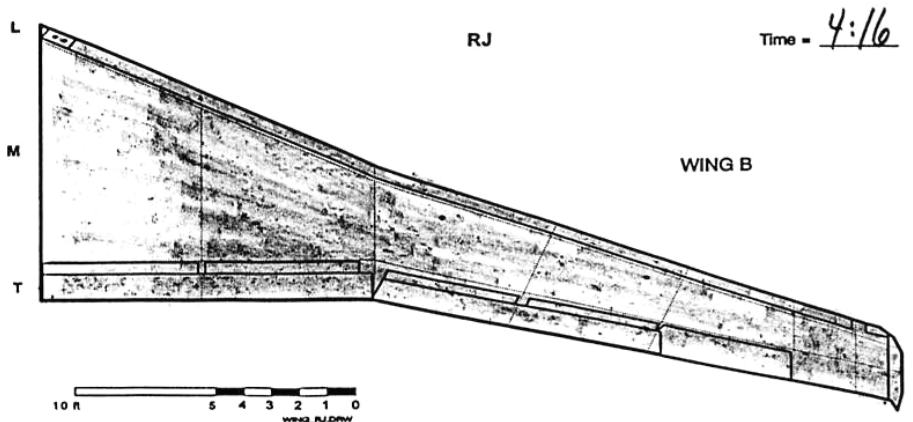
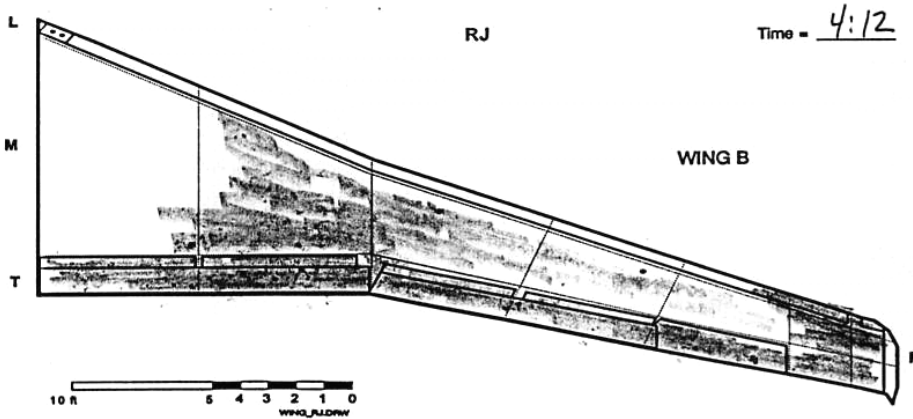
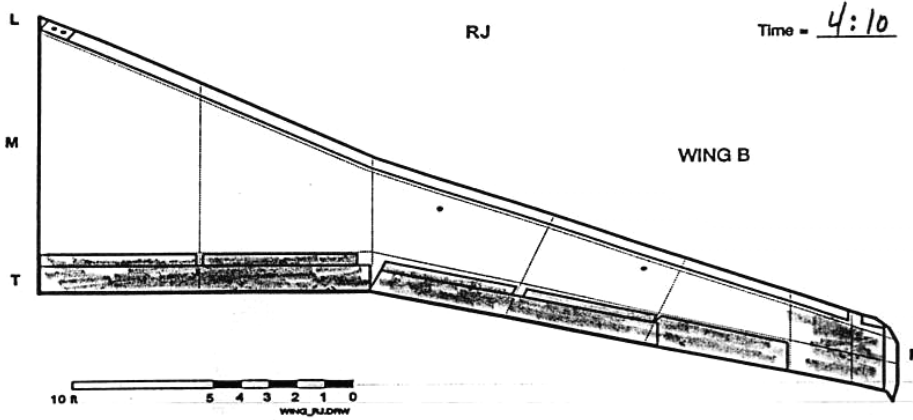

Note: To Compare to Flat Plate testing, subtract "Time of Initial Fluid Application".

FIGURE 5  
**LOCALIZED FORM FOR AIRCRAFT WING**

REMEMBER TO SYNCHRONIZE TIME

VERSION 4.0

Winter 1999/2000

DATE: JAN 26 / 00 RUN NUMBER: 8

FAILURES CALLED BY: M. CHAPUT

COMMENTS: \_\_\_\_\_

HANDWRITTEN BY: \_\_\_\_\_

ASSISTED BY: \_\_\_\_\_

**DRAW FAILURE CONTOURS (hr:min) AT PREDETERMINED LOCATIONS**

RJ

Time = \_\_\_\_\_

C-19

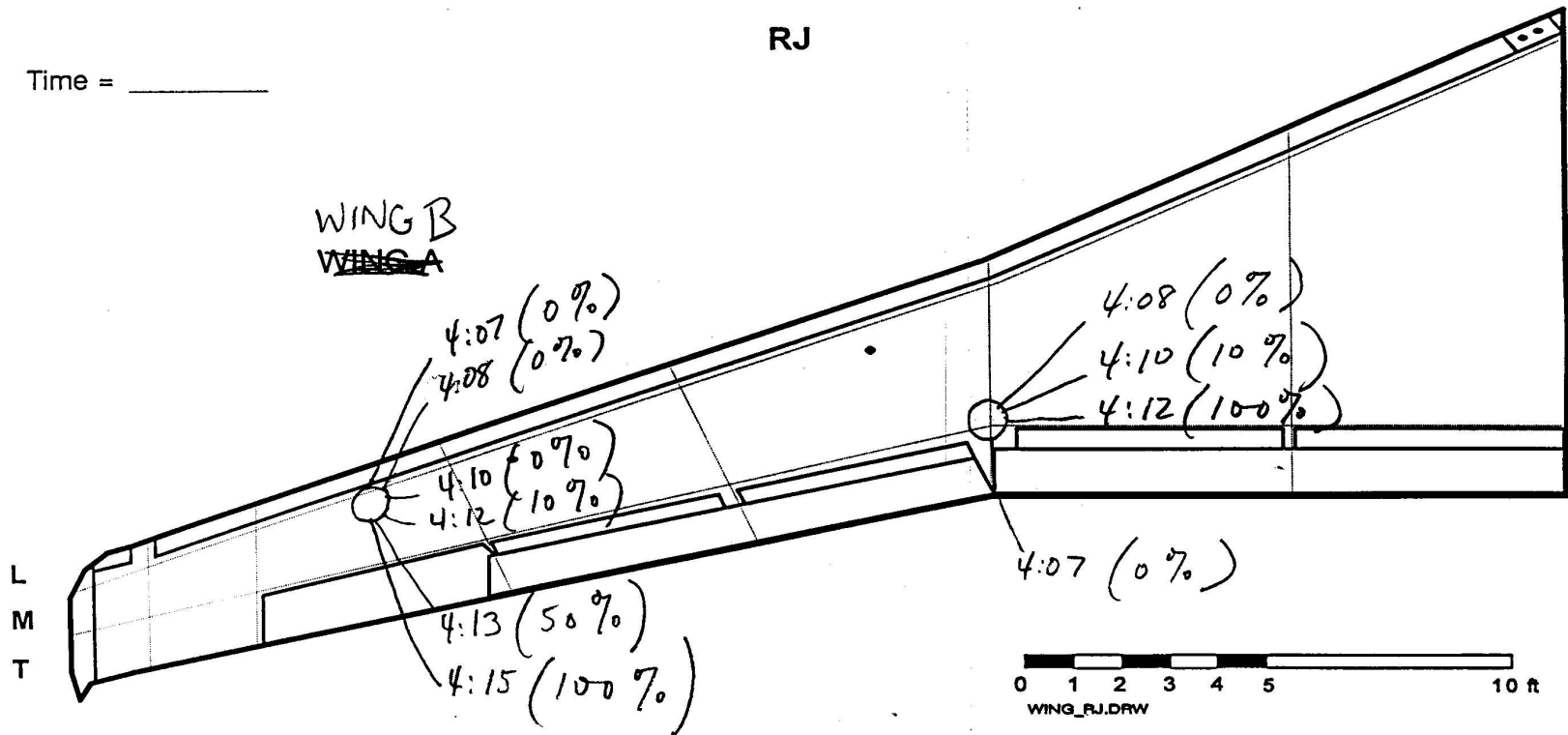

**APPENDIX D**

**DETAILED PRECIPITATION RATES  
JANUARY 26, 2000**



FIGURE D-1  
AIRCRAFT FULL-SCALE TESTS  
**PRECIPITATION RATES - January 26, 2000**  
ID # 1 & 2

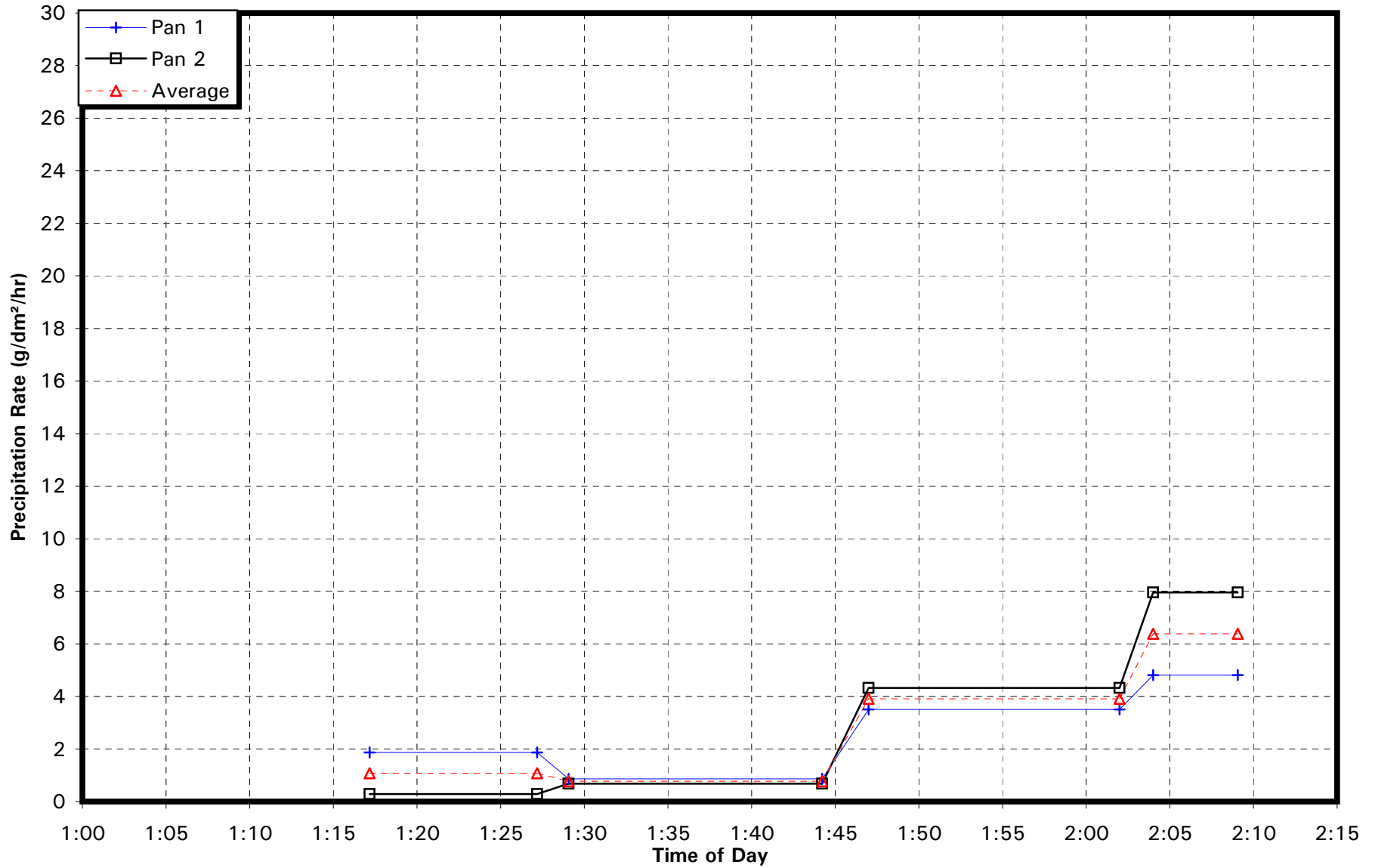

FIGURE D-2  
AIRCRAFT FULL-SCALE TESTS  
**PRECIPITATION RATES - January 26, 2000**  
ID 3 & 4

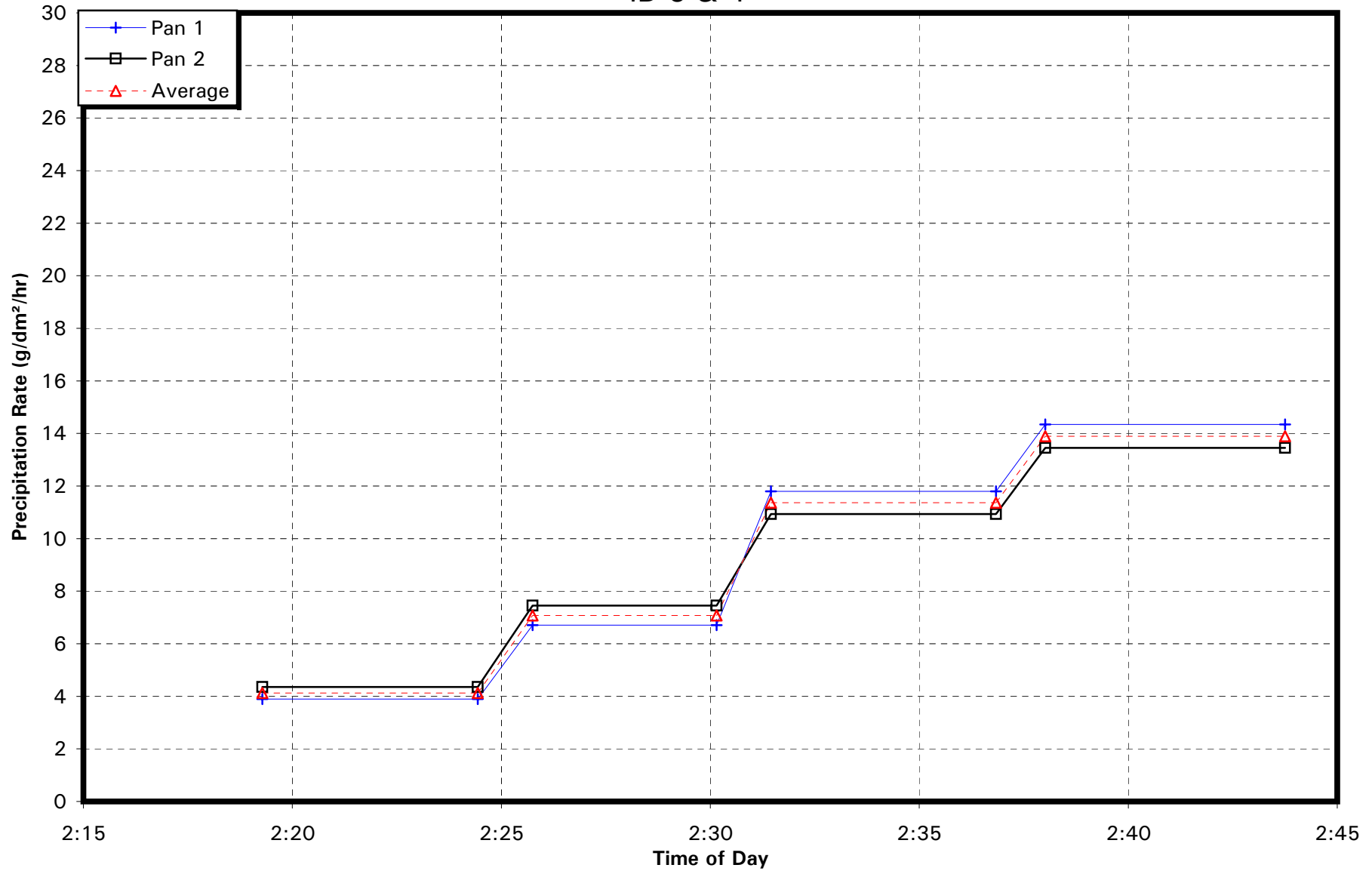

FIGURE D-3  
AIRCRAFT FULL-SCALE TESTS  
**PRECIPITATION RATES - January 26, 2000**  
ID # 5 & 6

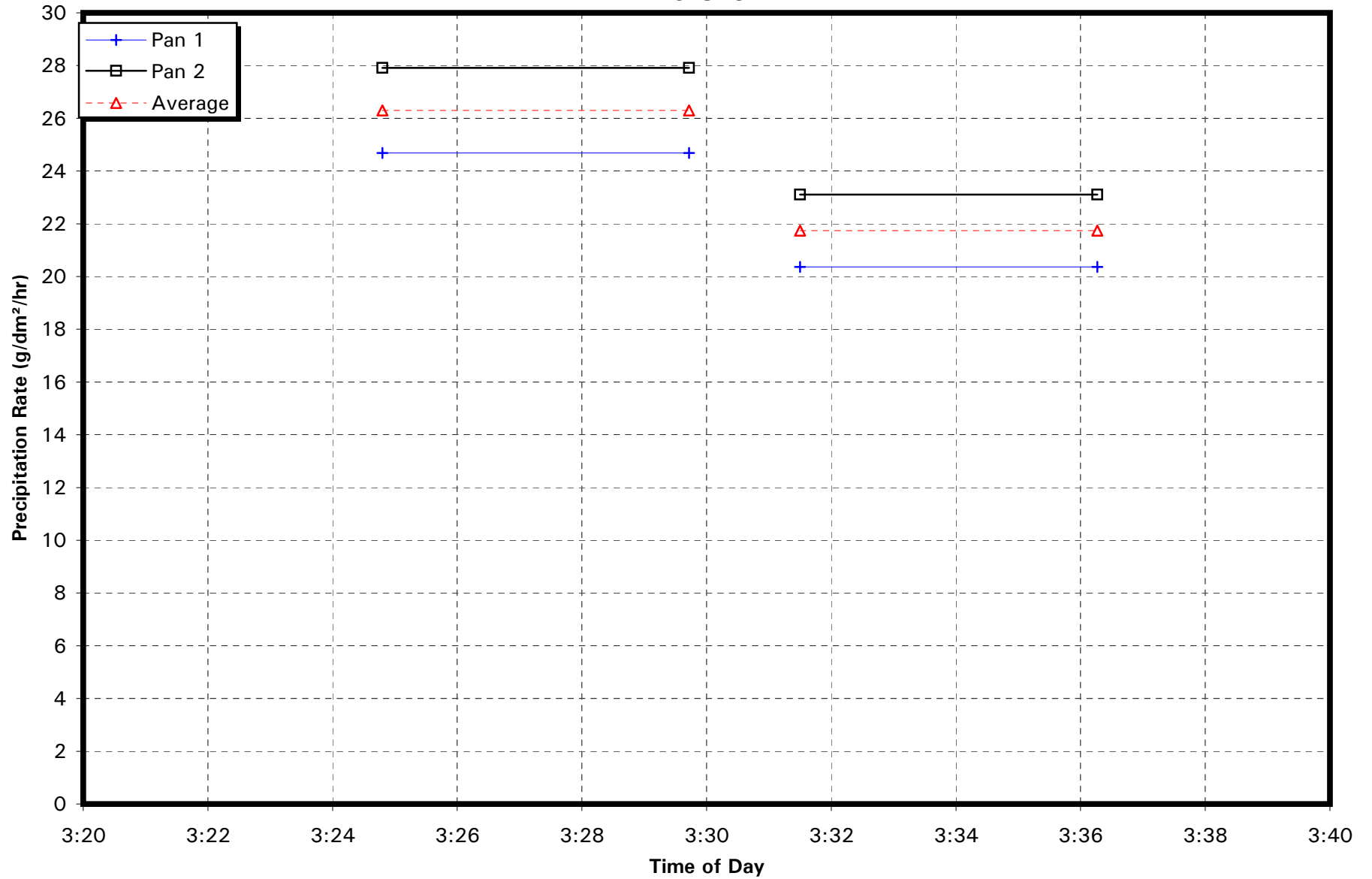
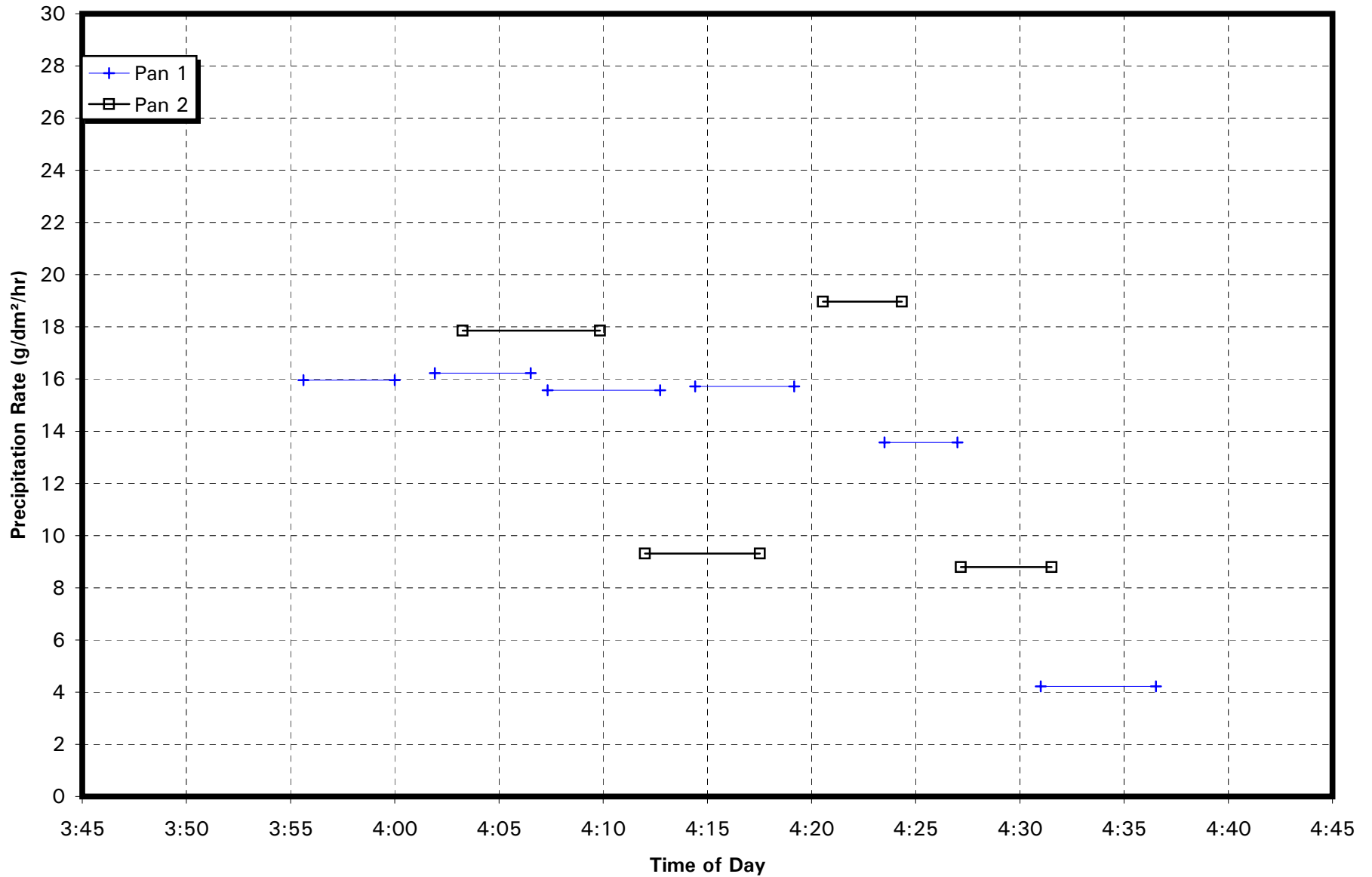

FIGURE D-4  
AIRCRAFT FULL-SCALE TESTS  
**PRECIPITATION RATES - January 26, 2000**  
ID # 7 & 8



**APPENDIX E**

**FLUID FREEZE POINT  
TEMPERATURE PROFILES**

FIGURE E-1  
**AIRCRAFT FULL-SCALE TESTS**  
**Fluid Freeze Point Temperature Profile**  
**UCAR XL54, OAT = -7°C, 3.0 g/dm<sup>2</sup>/h**  
 January 26, 2000 - ID # 1

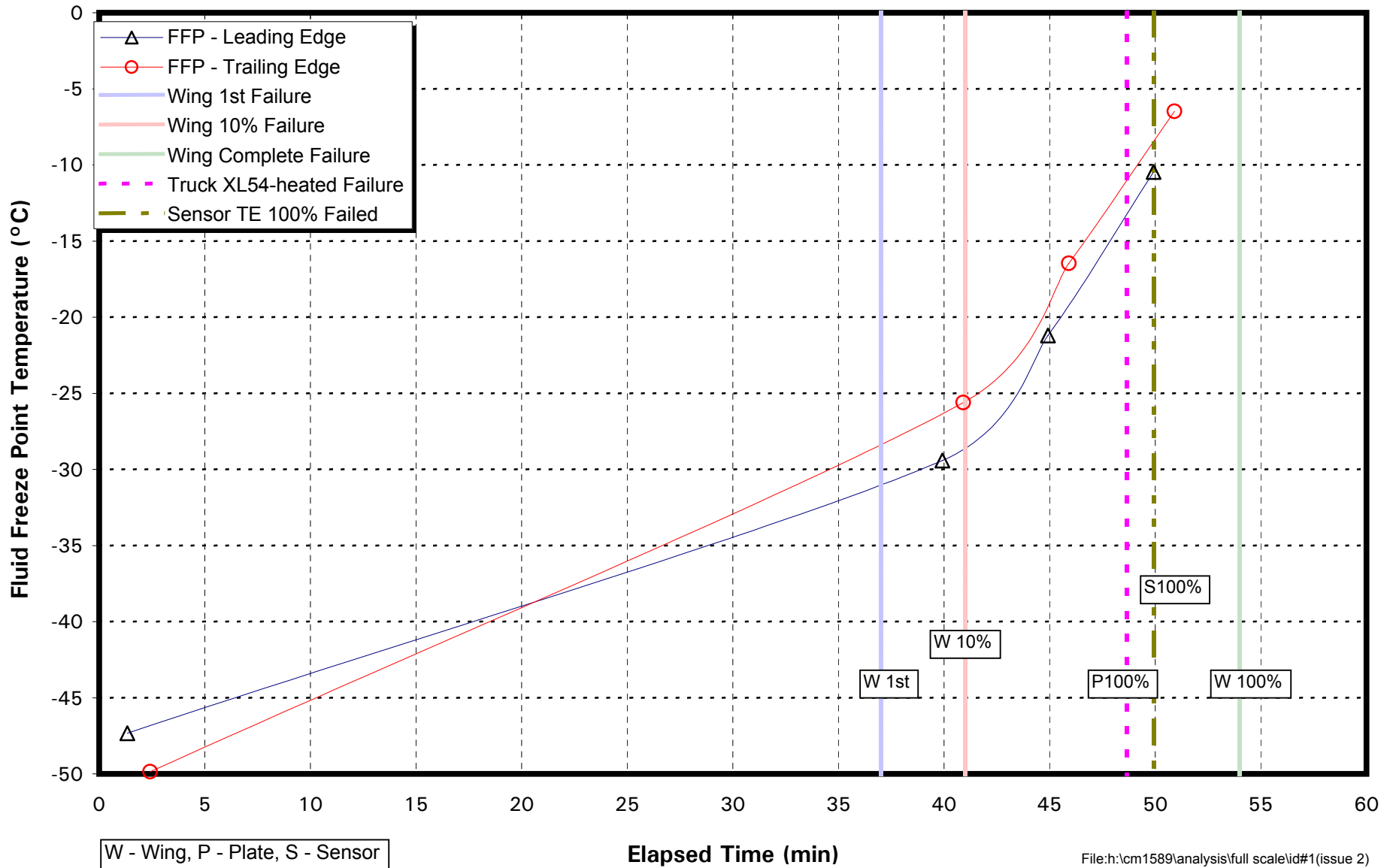

FIGURE E-2

### Fluid Freeze Point Temperature Profile UCAR XL54, OAT = -7°C, 3.0 g/dm<sup>2</sup>/h January 26, 2000 - ID # 2

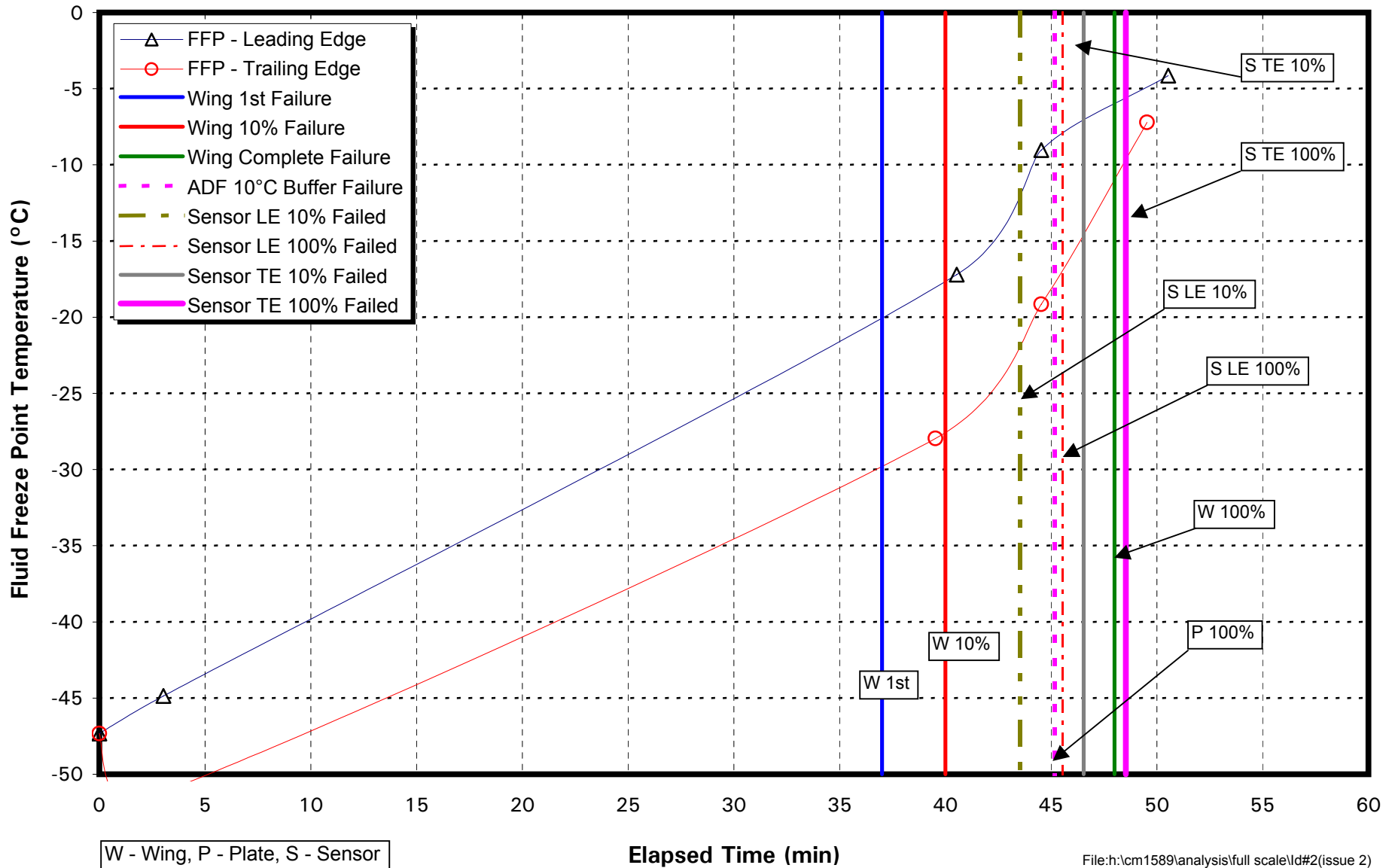

FIGURE E-3  
**Fluid Freeze Point Temperature Profile**  
**UCAR XL54, OAT = -6.6°C, 9.1 g/dm<sup>2</sup>/h**  
 January 26, 2000 - ID # 3

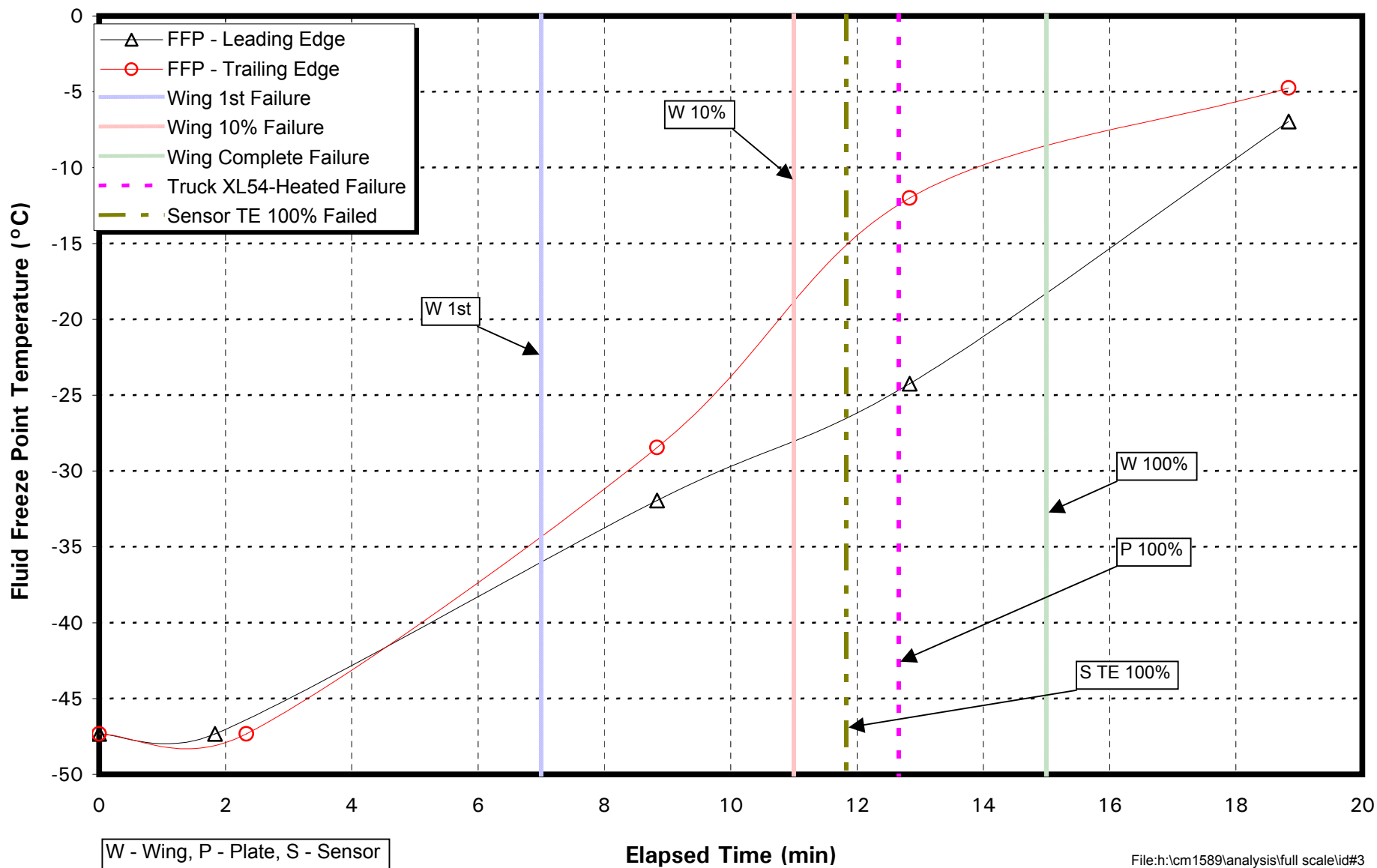
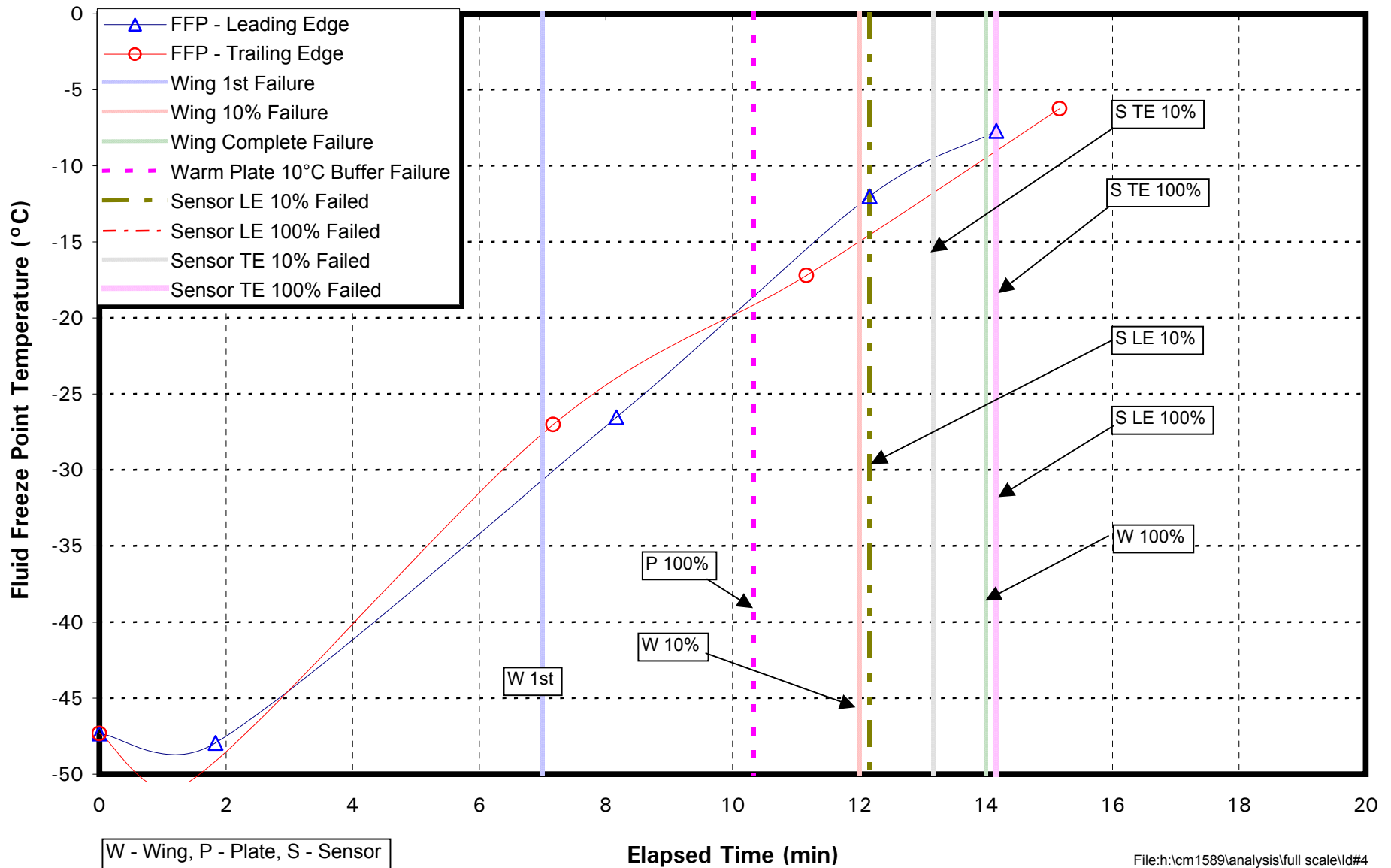

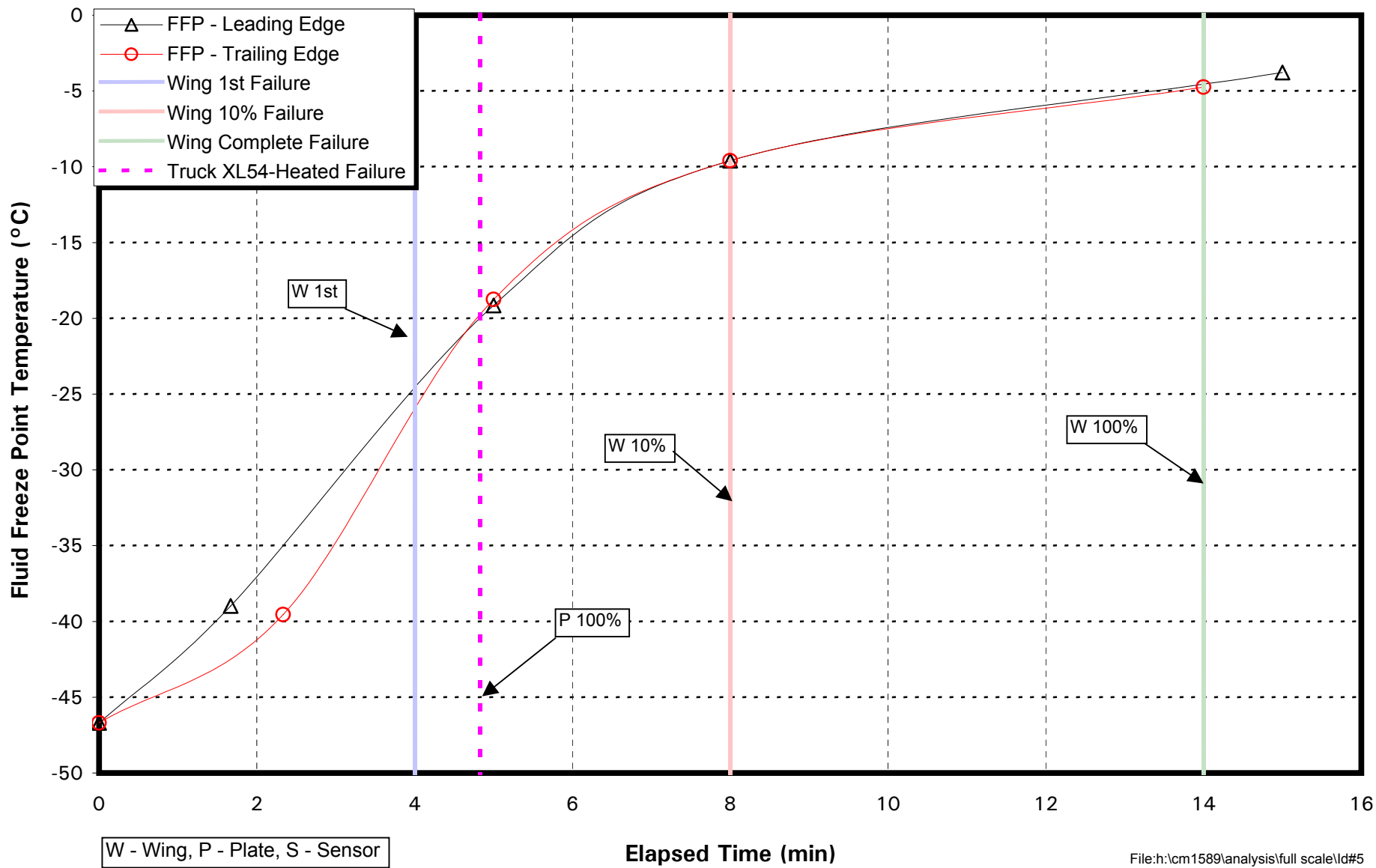

FIGURE E-4

### Fluid Freeze Point Temperature Profile UCAR XL54, OAT = -7°C, 9.1 g/dm<sup>2</sup>/h January 26, 2000 - ID # 4



**FIGURE E-5**  
**Fluid Freeze Point Temperature Profile**  
**UCAR XL54, OAT = -6.8°C, 24.0 g/dm<sup>2</sup>/h**  
 January 26, 2000 - ID # 5



W - Wing, P - Plate, S - Sensor

FIGURE E-6

### Fluid Freeze Point Temperature Profile UCAR XL54, OAT = -7°C, 24.0 g/dm<sup>2</sup>/h

January 26, 2000 - ID # 6

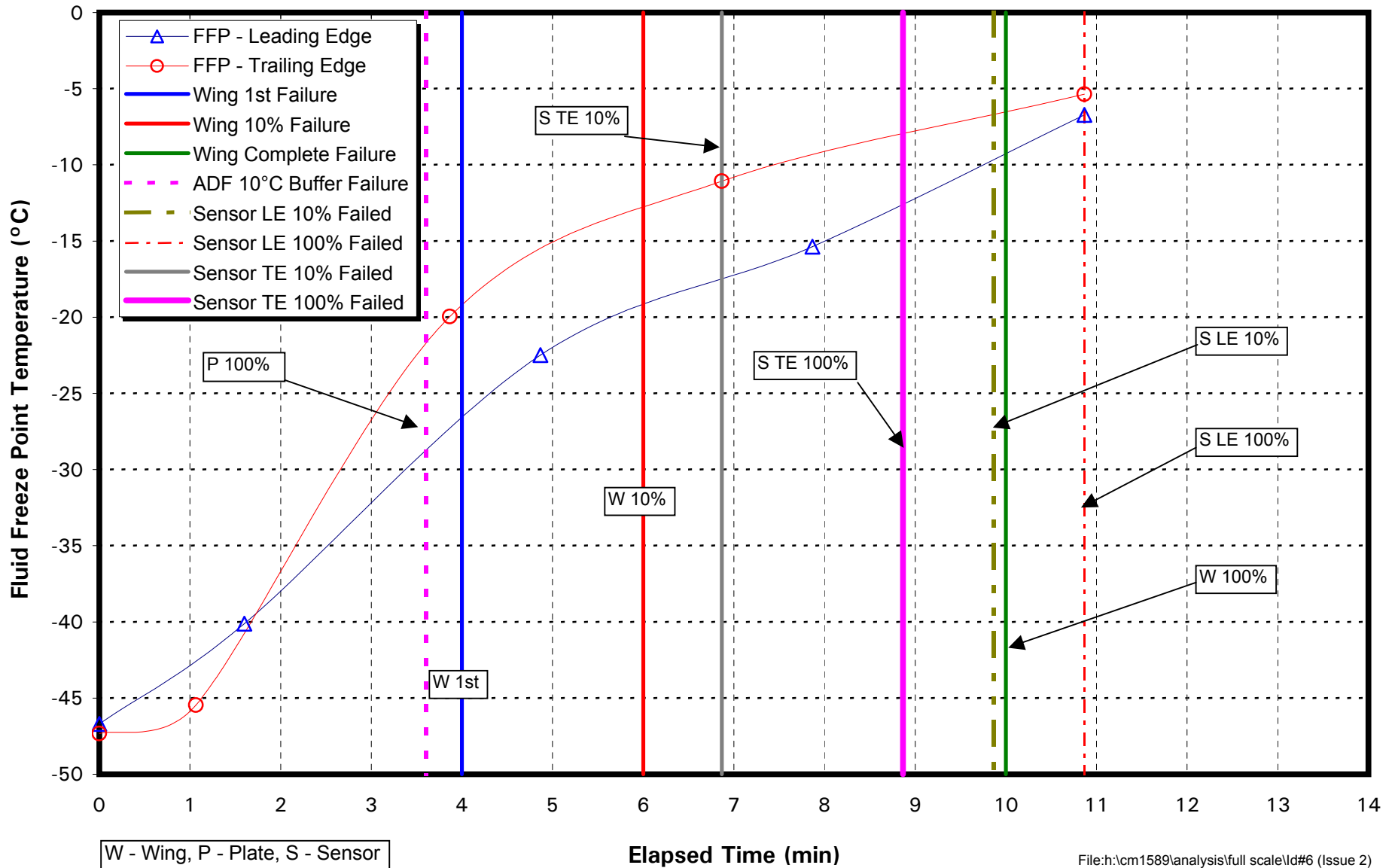
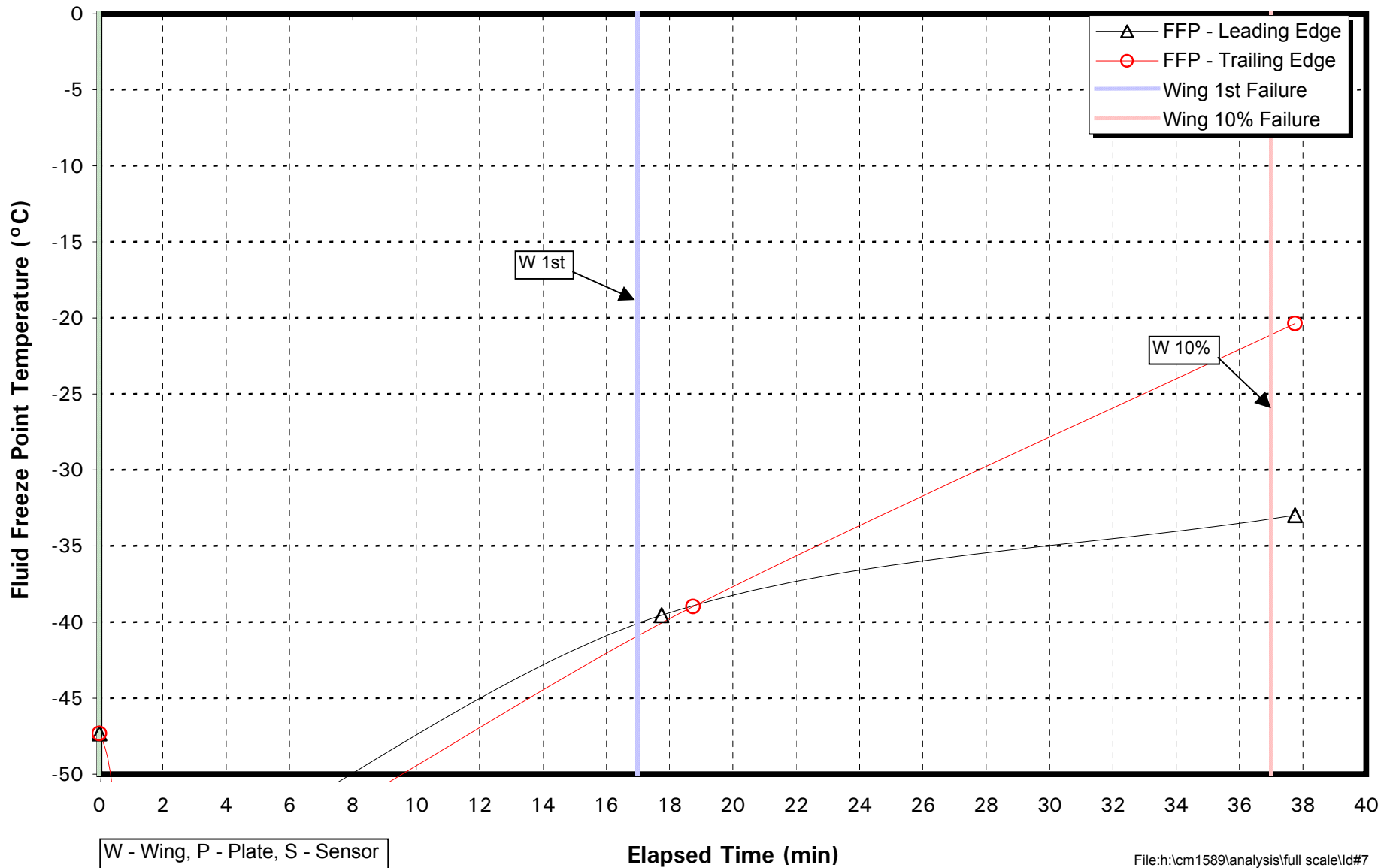
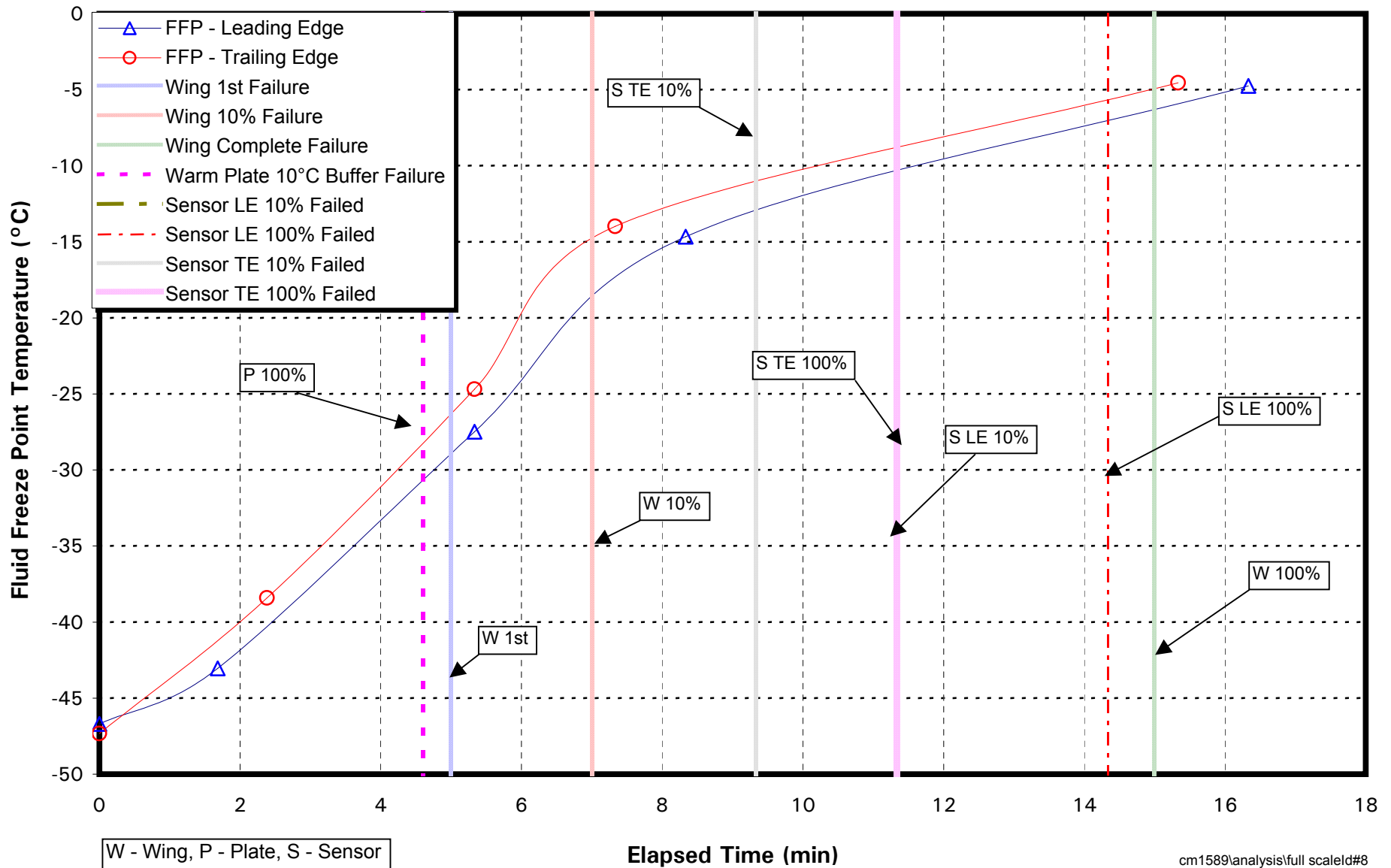

FIGURE E-7  
**Fluid Freeze Point Temperature Profile**  
**UCAR ULTRA + , OAT = -7.0°C, 14.0 g/dm<sup>2</sup>/h**  
January 26, 2000 - ID # 7



**FIGURE E-8**  
**Fluid Freeze Point Temperature Profile**  
**UCAR XL54, OAT = -6.9°C, 14.0 g/dm<sup>2</sup>/h**  
 January 26, 2000 - ID # 8



## **APPENDIX F**

### **PLATE AND WING FAILURE TIMES**

FIGURE F-1

### Plate and Wing Failure Times for Run 1

XL54 Fluid, OAT = -6.6°C, Rate = 3.0 g/dm<sup>2</sup>/h, Cross Wind 23 kph, Upwind Wing

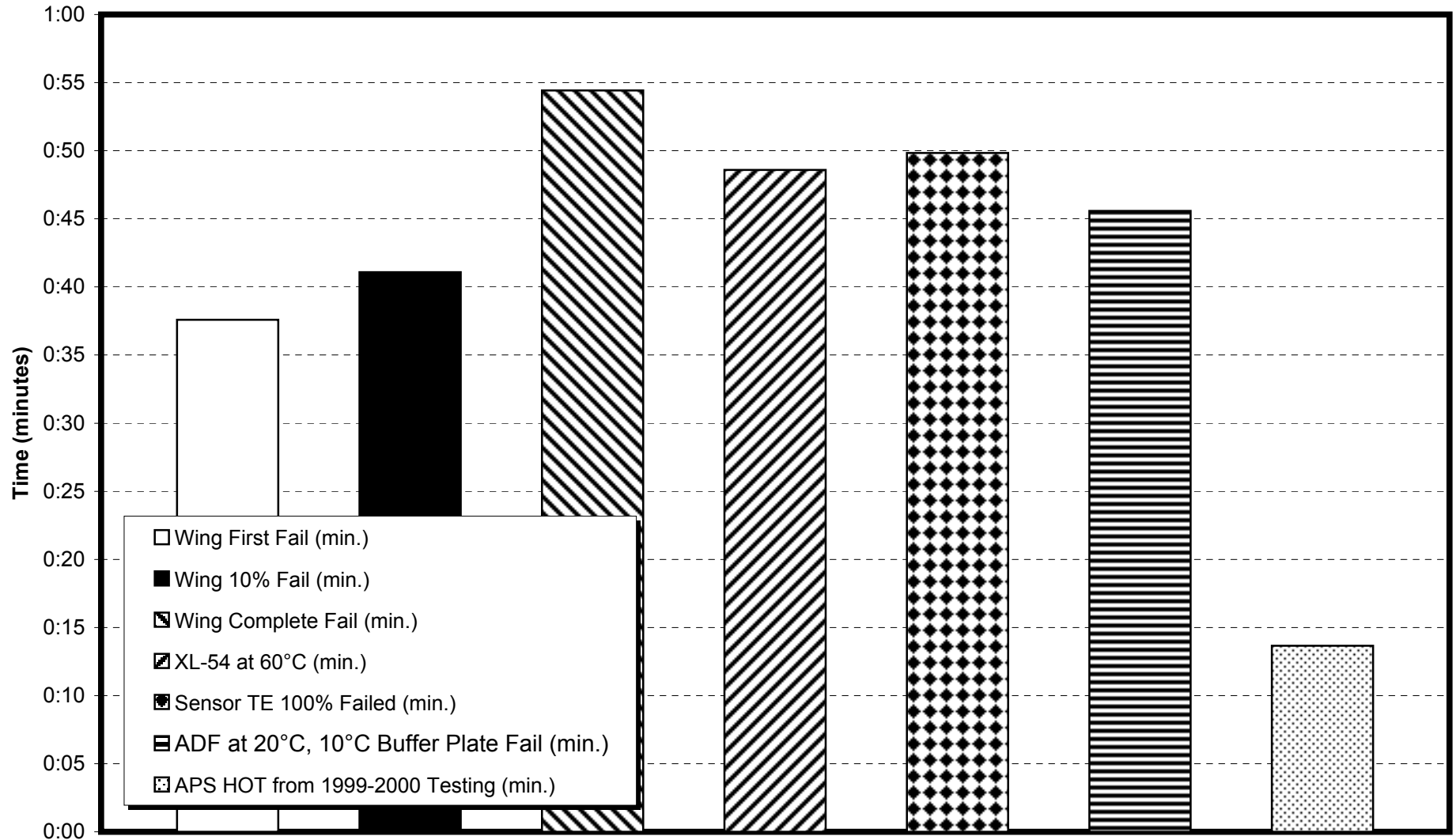

Note: Current SAE Type I HOT is 6 to 15 minutes

FIGURE F-2

### Plate and Wing Failure Times for Run 2

XL54 Fluid, OAT = -6.6°C, Rate = 3.0 g/dm<sup>2</sup>/hr, Crosswind 22 km/h, Downwind Wing

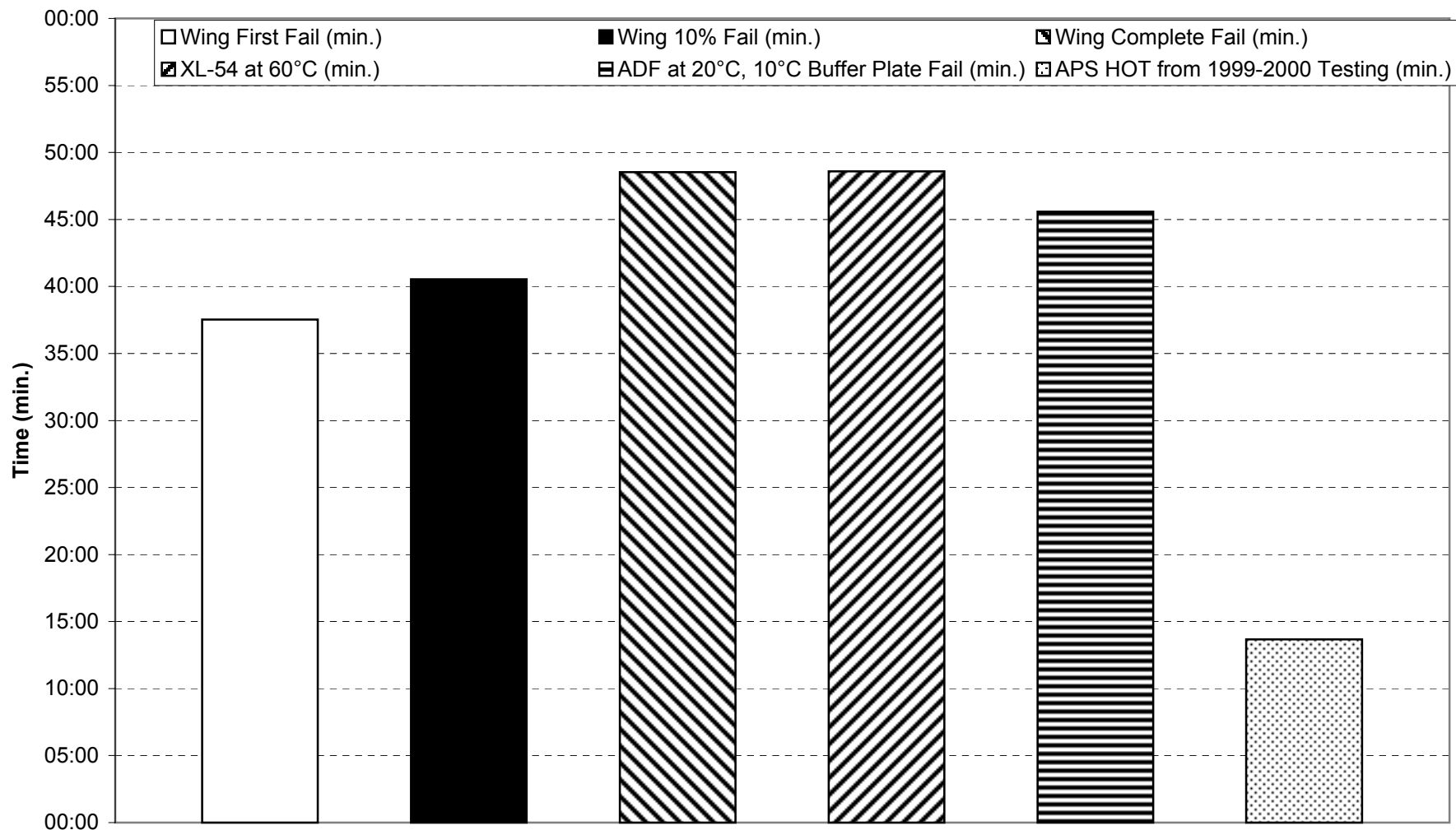

Note: Current SAE Type I HOT is 6 to 15 minutes



FIGURE F-3

### Plate and Wing Failure Times for Run 3

XL54 Fluid, OAT = -6.6°C, Rate = 9.1 g/dm<sup>2</sup>/hr, Crosswind 22 km/h, Upwind Wing

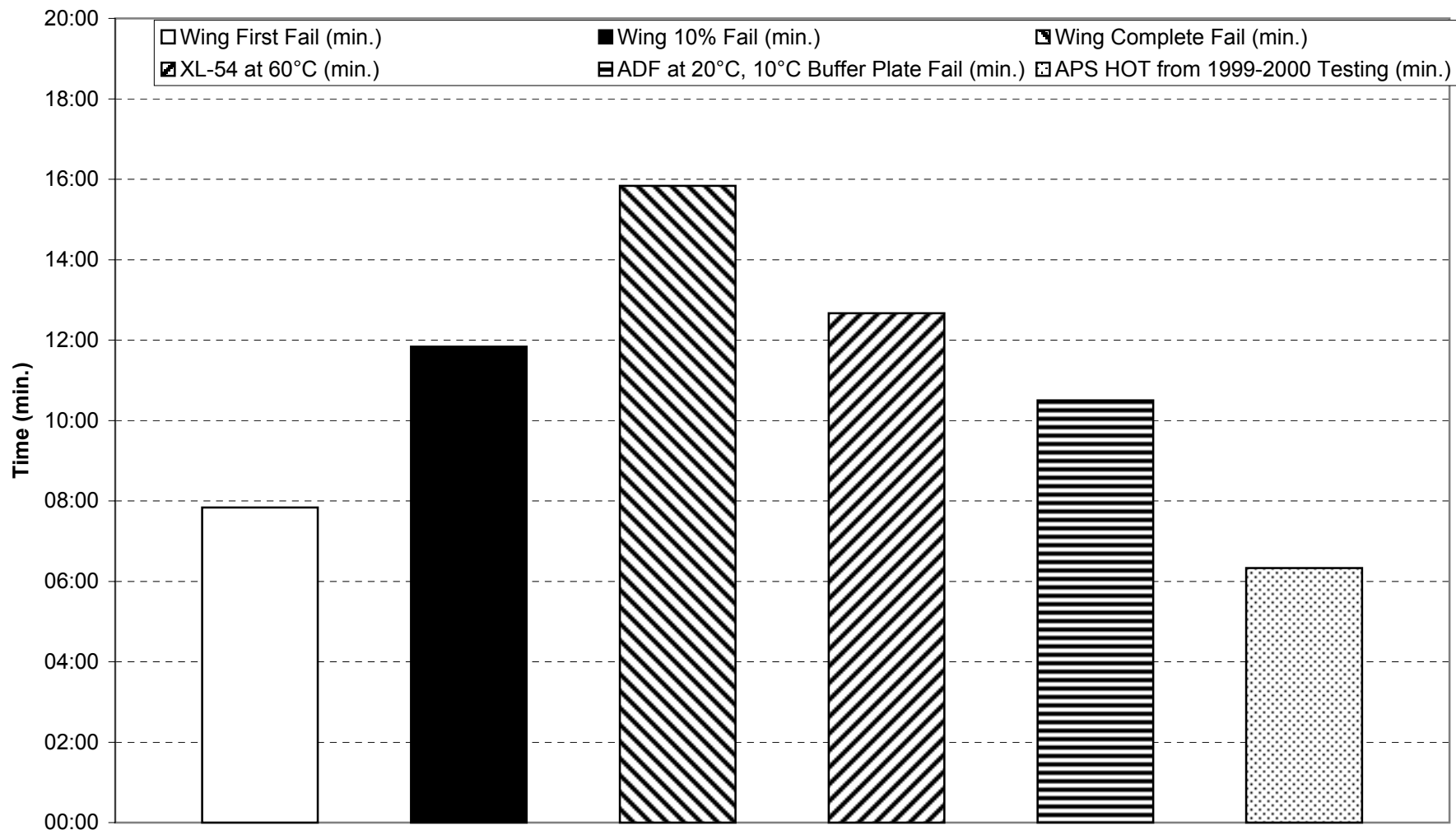

Note: Current SAE Type I HOT is 6 to 15 minutes

FIGURE F-4

### Plate and Wing Failure Times for Run 4

XL54 Fluid, OAT = -6.6°C, Rate = 9.1 g/dm<sup>2</sup>/hr, Crosswind 21 km/h, Downwind Wing

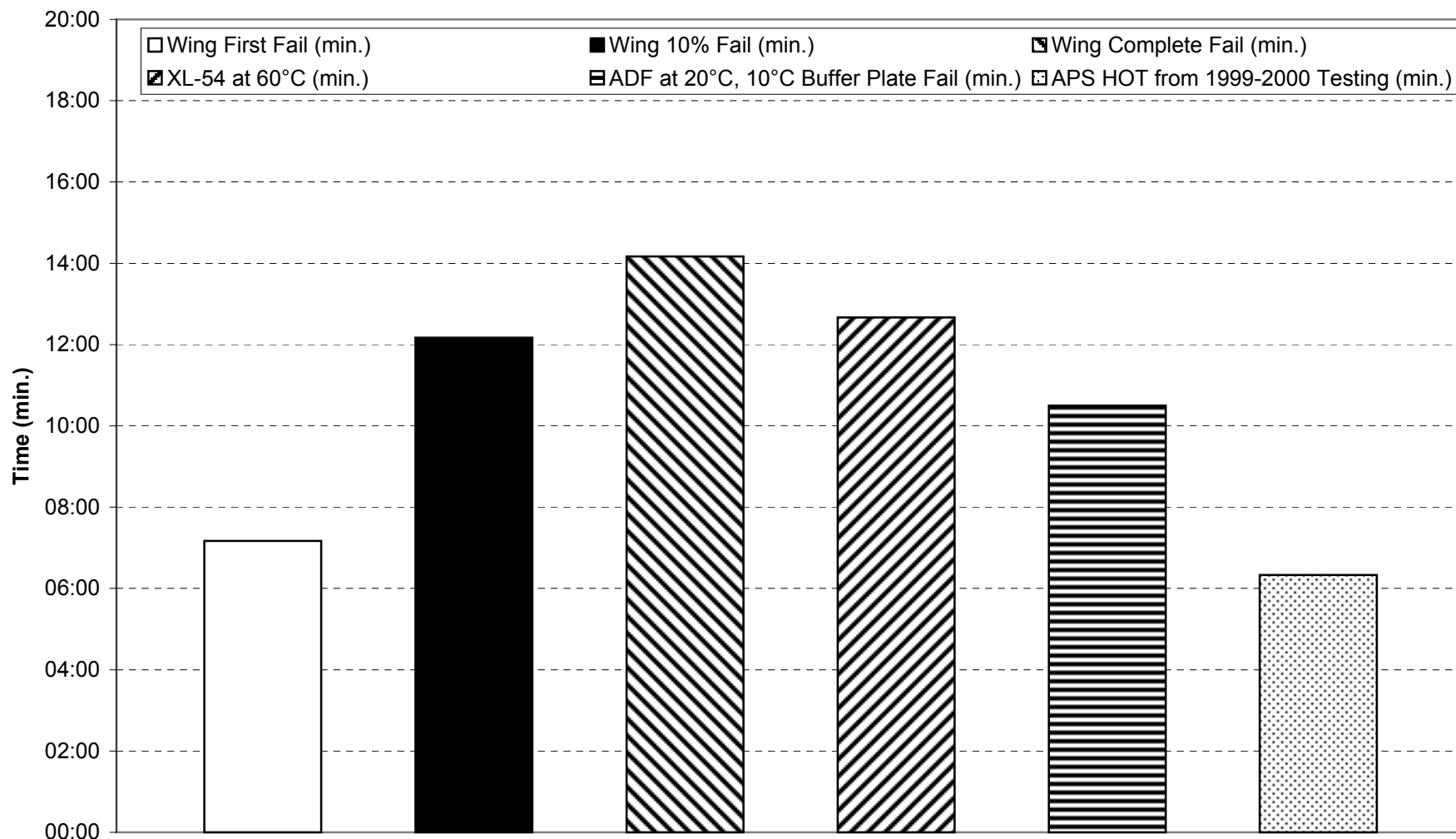

Note: Current SAE Type I HOT is 6 to 15 minutes

FIGURE F-5

### Plate and Wing Failure Times for Run 5

XL54 Fluid, OAT = -6.8°C, Rate = 24.0 g/dm<sup>2</sup>/hr, Tailwind 18 km/h

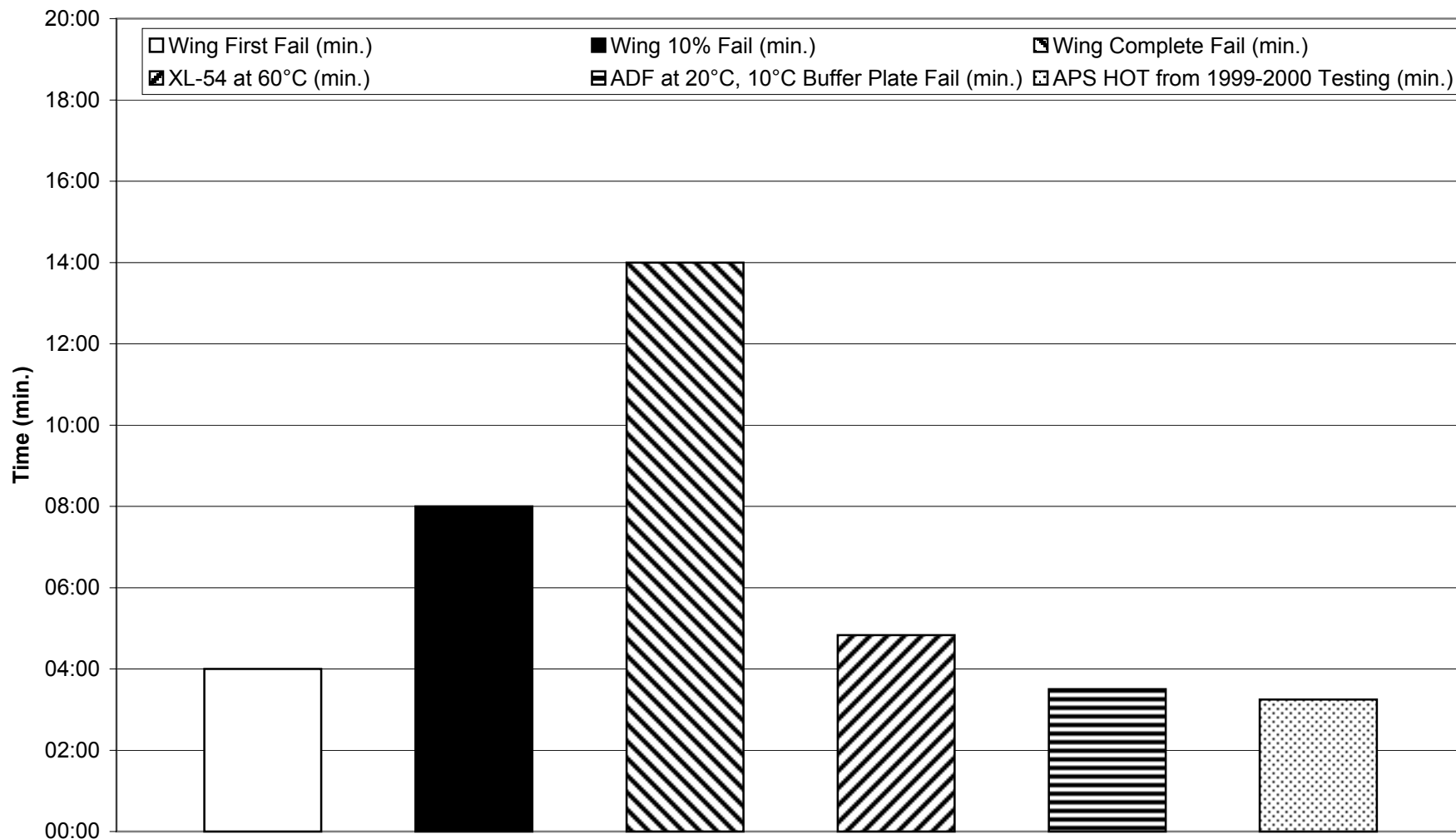

Note: Current SAE Type I HOT is 6 to 15 minutes

FIGURE F-6

### Plate and Wing Failure Times for Run 6

XL54 Fluid, OAT = -6.8°C, Rate = 24.0 g/dm<sup>2</sup>/hr, Tailwind 17 km/h

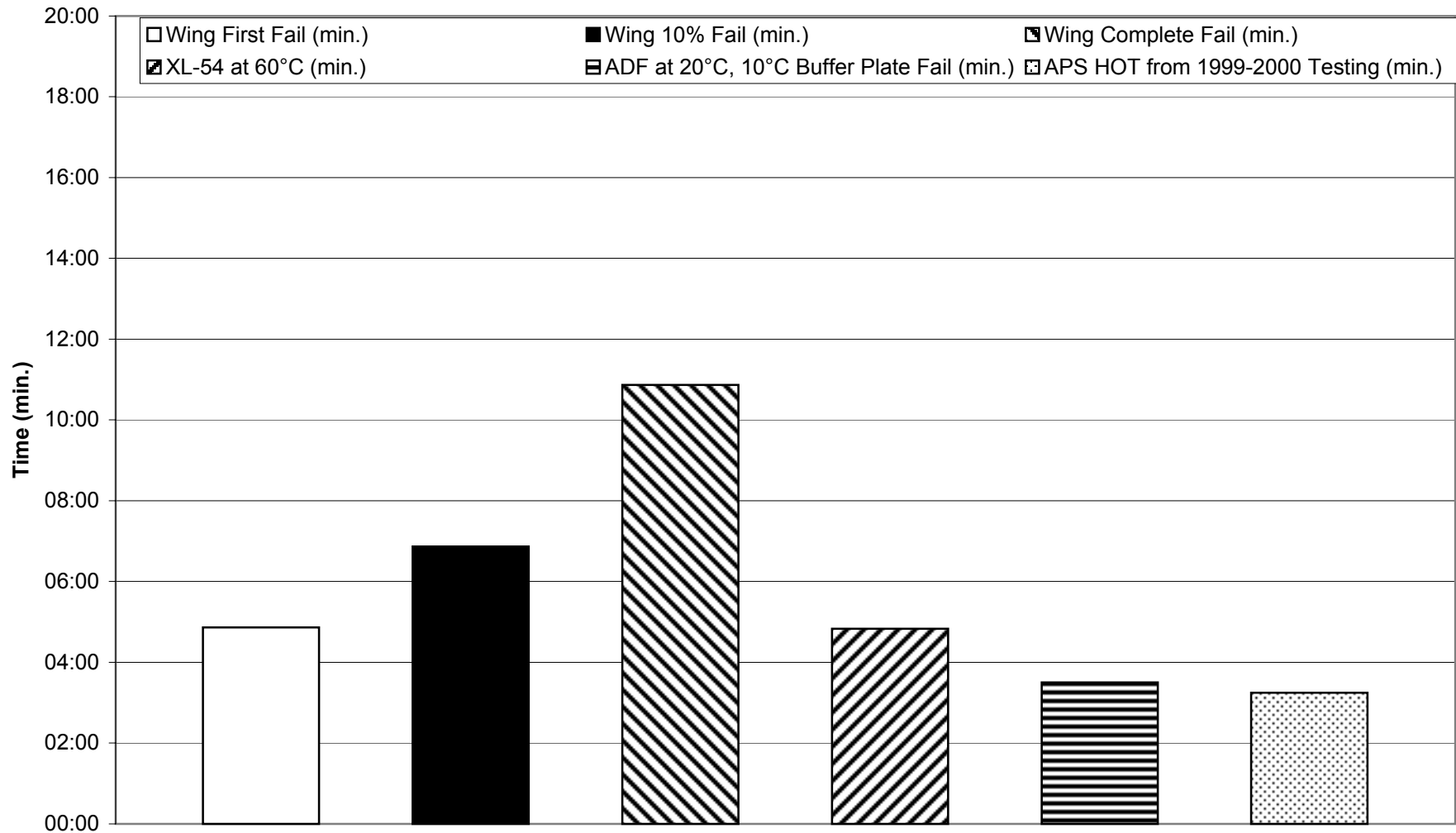

Note: Current SAE Type I HOT is 6 to 15 minutes

FIGURE F-7

### Plate and Wing Failure Times for Run 7

XL54/Ultra+ Fluids, OAT = -7.0°C, Rate = 14.0 g/dm<sup>2</sup>/hr, Headwind 15 km/h

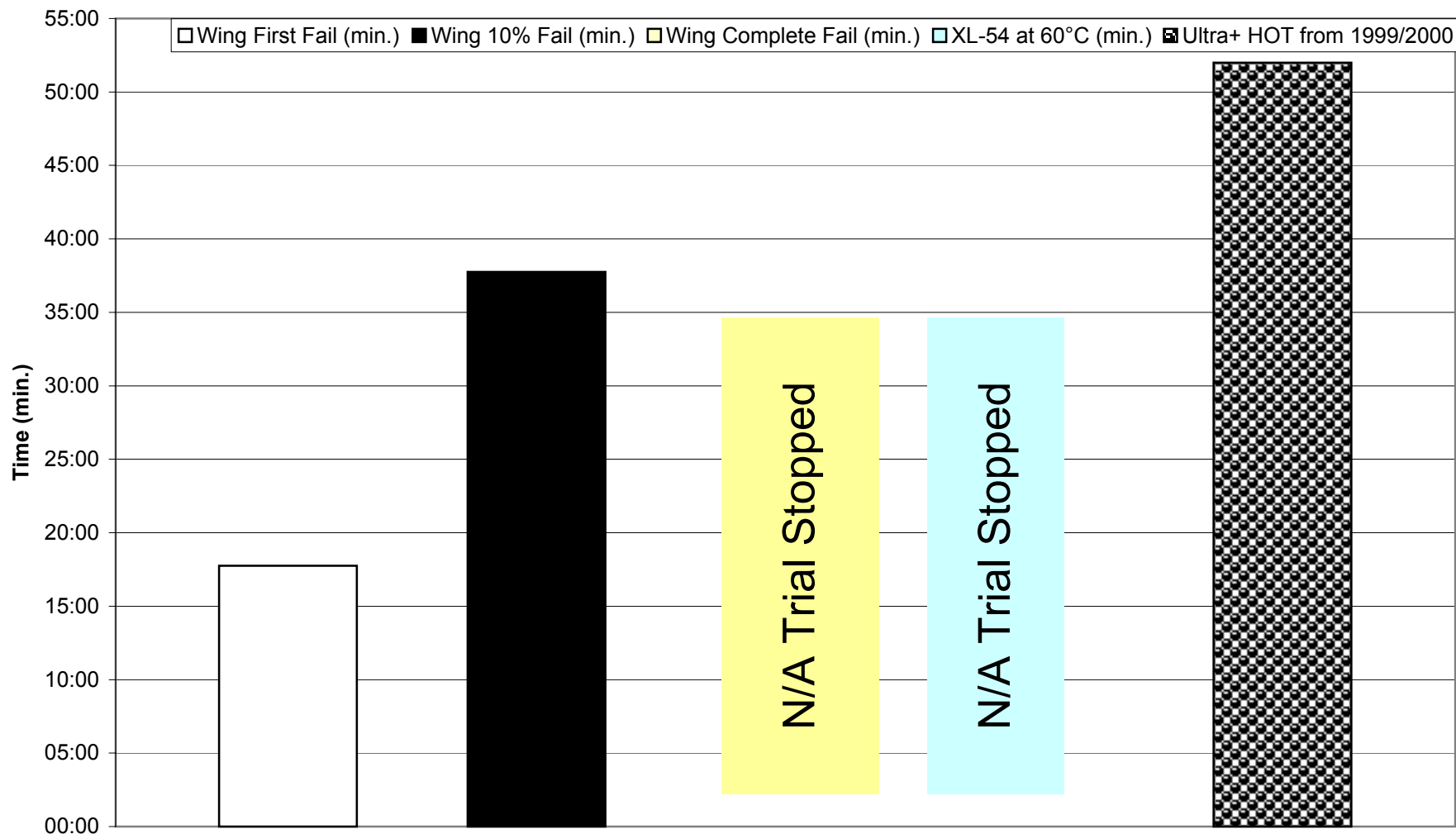

Note: When the trial was stopped, the test plates were approaching three inch line failures.

FIGURE F-8

### Plate and Wing Failure Times for Run 8

XL54 Fluid, OAT = -6.9°C, Rate = 14.0 g/dm<sup>2</sup>/hr, Headwind 15 km/h

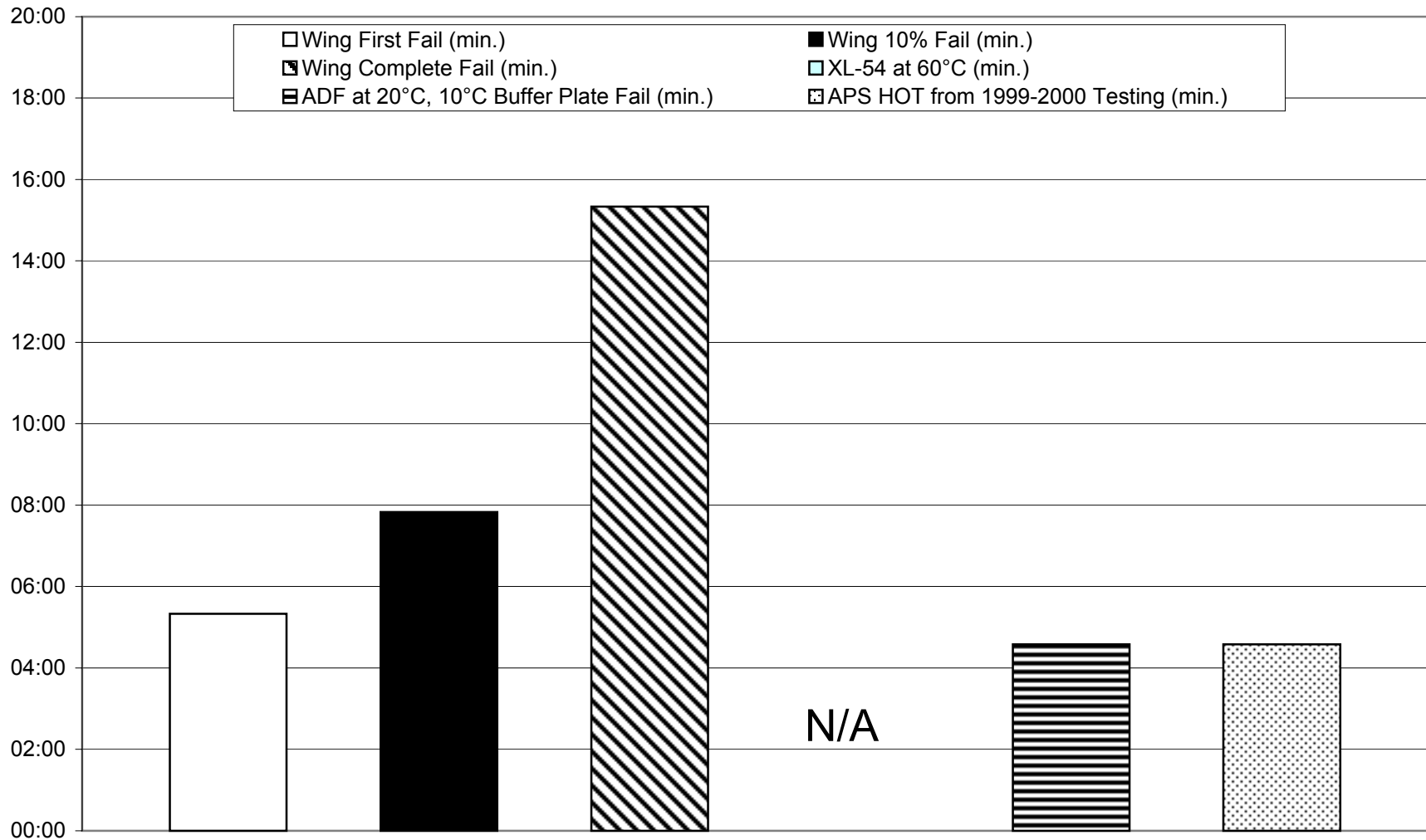

Note: Current SAE Type I HOT is 6 to 15 minutes