

Aircraft Full-Scale Test Program for the 1994-1995 Winter

- Aircraft/Flat Plate Simultaneous Tests
- Fluid Thickness Profile
- Wing Temperature Profile

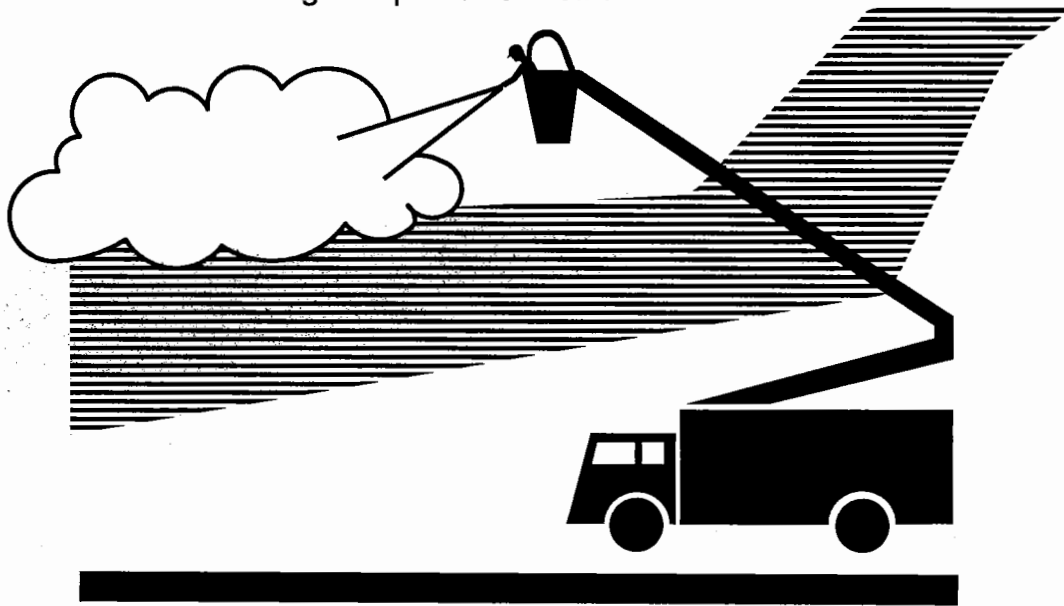

Prepared for

Dryden Commission Implementation Project
Transport Canada

by

APS AVIATION INC. **APS**

December 1995

**Aircraft Full-Scale Test Program
for the
1994-1995 Winter**

- Aircraft/Flat Plate Simultaneous Tests
- Fluid Thickness Profile
- Wing Temperature Profile

Prepared for
Dryden Commission Implementation Project
Transport Canada

by
The logo for APS Aviation Inc. features the text "APS AVIATION INC." in a sans-serif font, followed by a stylized, bold "APS" in a larger font. A horizontal line is positioned below the text.

John D'Avirro, Ziad Boutanios, Peter Dawson

December 1995

The contents of this report reflect the views of APS Aviation Inc. and not necessarily the official view or opinions of the Dryden Commission Implementation Project of Transport Canada.

Un sommaire en français de ce rapport est inclus.

PREFACE

PREFACE

At the request of the Dryden Commission Implementation Program of Transport Canada, APS Aviation Inc. has undertaken a research program to further advance aircraft ground de-icing/anti-icing technology. Specific objectives of the overall program were:

- Substantiation of SAE/ISO Holdover Time Tables that define a de-icing fluid's ability to delay ice formation by conducting tests on flat plates under conditions of natural snow, simulated freezing drizzle, simulated light freezing rain, and simulated freezing fog for a range of fluid dilutions and temperature conditions;
- Development of data for "cold-soaked" wing conditions using cooled flat plates to simulate the conditions;
- Correlation of flat plate test data with the performance of various fluids on service aircraft by concurrent testing;
- Evaluation of the suitability of hot blown air equipment to remove frost at extreme low temperatures;
- Evaluation of the suitability of equipment which blows air to remove snow;
- Determination of the environmental limits for use of hot water as a de-icing fluid;
- Evaluation of a remote sensor to detect contamination on wing surfaces;
- Determination of the pattern of fluid run-off from the wing during take-off; and
- Determination of wing temperature profiles during and after the de-icing operation.

PREFACE

The research activities of the program conducted on behalf of Transport Canada during the 1994/95 winter season are documented in four separate reports. The titles of these reports are as follows:

- TP 12595E Aircraft Full-Scale Test Program for the 1994/95 Winter;
- TP 12653E Hot Water De-Icing Trials for the 1994/95 Winter;
- TP 12654E Aircraft Ground De/Anti-icing Fluid Holdover Time Field Testing Program for the 1994/95 Winter; and
- TP 12655E Forced Air De-Icing Trials for the 1994/95 Winter.

Three additional reports were produced as a part of this research program. The titles of these reports are as follows:

- TP 12676E Consolidated Fluid Holdover Time Test Data;
- TP 12677E Consolidated Research and Development Report; and
- TP 12678E Methodology for Simulating a Cold-Soaked Wing.

This report TP 12595E addresses the objective of correlating flat plate test data with the performance of fluids on aircraft wings, determining the patterns of fluid run-off from the wing and determining wing temperature profiles.

The completion of this program could not have occurred without the assistance of many individuals and organizations. APS would therefore like to thank the Dryden Commission Implementation Project, Transportation Development Centre, the Federal Aviation Administration, the National Research Council, Atmospheric Environment Services, Transport Canada and the fluid manufacturers for their contribution and assistance in the project. Special thanks are extended to Aeromag 2000, Aerotech International Incorporated, Air Atlantic, Air Canada, Calm Air, Canadian Airlines International, CanAir Cargo and United Airlines for their cooperation, personnel and facilities.

1. Transport Canada Publication No. TP 12595E		2. Project No. DC 124		3. Recipient's Catalogue No.	
4. Title and Subtitle Aircraft Full-Scale Test Program for the 1994-1995 Winter				5. Publication Date December 1995	
				6. Performing Organization Document No. CM1222.001	
7. Author(s) J. D'Avirro, Z. Boutanios, P. Dawson				8. Transport Canada File No. DC 124	
9. Performing Organization Name and Address APS Aviation Inc. 1100 René-Lévesque Blvd. W., Suite 1340 Montreal, Quebec Canada H3B 4N4				10. PWGSC File No. XSD94-00180-(651)	
				11. PWGSC or Transport Canada Contract No. T-8047-4-0124/01XSD	
12. Sponsoring Agency Name and Address Transportation Development Centre (TDC) 800 René Lévesque Blvd. West 6th Floor Montreal, Quebec H3B 1X9				13. Type of Publication and Period Covered Final	
				14. Project Officer Barry Myers	
15. Supplementary Notes (Funding programs, titles of related publications, etc.) Research reports produced on behalf of Transport Canada for testing during previous winters are available as follows: TP 11206E 1990/91; TP 11454E 1991/92; TP 11836E 1992/93; and 1993/94 Summary Report submitted to DCIP. Seven reports (including this report) were produced as part of this winter's research program: TP 12595E Full-Scale Tests; TP 12653E Hot Water; TP 12655E Forced Air; TP 12654E Holdover Time Substantiation; TP 12676E Consolidated Holdover Time Data; TP 12678E Methodology for Simulating a Cold-Soaked Wing; and TP 12677E Consolidated Research and Development.					
16. Abstract <p>The prime objective of this study was to compare behaviour of fluids on flat plates as employed in standard test procedures to determine fluid holdover times with the performance on real aircraft wings, and to establish the validity of the flat plate as a wing representation. Secondary objectives included examination of various aspects of fluid failure on the aircraft.</p> <p>Simultaneous trials were conducted employing standard flat plates along with actual aircraft, in natural precipitation conditions. Both Type I and Type II fluids were employed in the trials. A total of thirty-nine (39) tests were conducted at three locations; nine at Dorval, twenty-eight at St. John's, Nfld. and two at Toronto.</p> <p>Results showed that for Type I fluids, flat plates are a satisfactory representation of the fluid behaviour on aircraft wing surfaces.</p> <p>Tests performed with Union Carbide Ultra Type II neat fluid resulted in fluid failures on aircraft wings earlier than on flat plates. Factors associated with application procedures, not fluid characteristics, are believed to have contributed to this early failure. Further tests are planned.</p> <p>The trailing edge and the leading edge appear to be the most failure sensitive regions. The representative surfaces used by Canadian airline operators were not found to present a conclusive representation of the condition of the aircraft wing surface. The view of the aircraft representative surfaces from the cabin was in general not adequate for the pilot to make a valid assessment of wing condition.</p> <p>Further activities are recommended to investigate the impact of application methods on Type II fluid holdover time, and to compare the performance of Type II fluid on wing surfaces with flat plate test results.</p>					
17. Key Words Aircraft, Snow, Drizzle, Rain, Anti-icing, Fluid, Hold-over, Precipitation, Wing, Plate, De-icing, Ice, Sensor, Temperature, Thickness			18. Distribution Statement Limited number of copies available from the Transportation Development Centre		
19. Security Classification (of this publication) Unclassified		20. Security Classification (of this page) Unclassified		21. Declassification (date) —	22. No. of Pages xx, 90, apps
					23. Price —

1. N° de la publication de Transports Canada TP 12595E		2. N° de l'étude DC 124		3. N° de catalogue du destinataire		
4. Titre et sous-titre Aircraft Full-Scale Test Program for the 1994-1995 Winter				5. Date de la publication Décembre 1995		
				6. N° du document de l'organisme exécutant CM1222.001		
7. Auteur(s) J. D'Avirro, Z. Boutanios, P. Dawson				8. N° de dossier — Transports Canada DC 124		
9. Nom et adresse de l'organisme exécutant APS Aviation Inc. 1100, boul. René-Lévesque Ouest, bureau 1340 Montréal, Québec Canada H3B 4N4				10. N° de dossier — TPSGC XSD94-00180-(651)		
				11. N° de contrat — TPSGC ou Transports Canada T-8047-4-0124/01XSD		
12. Nom et adresse de l'organisme parrain Centre de développement des transports (CDT) 800, boul. René-Lévesque Ouest 6 ^e étage Montréal (Québec) H3B 1X9				13. Genre de publication et période visée Final		
				14. Agent de projet Barry Myers		
15. Remarques additionnelles (Programmes de financement, titres de publications connexes, etc.) Transports Canada a fait produire les rapports de recherche suivants sur les essais menés durant les hivers précédents : TP 11206E pour 1990-1991; TP 11454E pour 1991-1992; TP 11836E pour 1992-1993 et le sommaire pour l'année 1993-1994 présenté au Comité de mise en oeuvre de la Commission Dryden. Concernant le programme de recherche mené durant l'hiver de 1994-1995, les sept rapports suivants (y compris le présent) ont été produits : TP 12595E Full-Scale Tests; TP 12653E Hot Water; TP 12655E Forced Air; TP 12654E Holdover Time Substantiation; TP 12676E Consolidated Holdover Time Data; TP 12678E Methodology for Simulating a Cold-Soaked Wing; et enfin TP 12677E Consolidated Research and Development.						
16. Résumé <p>Le but premier de cette étude était de comparer le comportement de différents agents de dégivrage/antigivrage sur plaques planes avec le comportement de ces mêmes agents sur les surfaces portantes d'avions réels, et de déterminer dans quelle mesure les résultats des essais sur plaques planes sont représentatifs du comportement de ces agents dans des conditions réelles de service. La détermination des différents autres effets constatés une fois que ces agents cessaient d'être efficaces figurait parmi les objectifs secondaires fixés à la recherche.</p> <p>Les essais consistaient à déposer simultanément un agent de type I ou II sur des plaques planes normalisées et sur les ailes d'un avion dans des conditions de précipitation naturelle. Au total, 39 tests ont été menés : 9 à Dorval, 28 à St. John's et 2 à Toronto.</p> <p>Les résultats montrent que les valeurs d'efficacité sur plaques planes sont représentatives dans une bonne mesure des durées d'efficacité de l'agent type I sur une aile d'avion.</p> <p>Des tests ont été menés avec le nouveau fluide type II de Union Carbide, appelé <i>Ultra</i>, et chaque fois, sa durée d'efficacité sur aile a été moindre que sur plaques planes. Cet écart peut être attribué à un certain nombre de causes probables liées à la méthode avec laquelle ce fluide est déposé sur l'aile, et non aux propriétés du fluide. Des tests plus poussés sont en préparation.</p> <p>Les bords d'attaque et de fuite semblent être les parties les plus vulnérables des ailes. Le tronçon de l'aile appelé représentatif ne peut être considéré comme indicatif de l'état où se trouvent les autres parties de l'aile. La vue que le pilote a de ce tronçon d'aile dit représentatif depuis l'intérieur de la cabine n'est pas bonne au point de lui permettre de se prononcer avec certitude sur l'état général des ailes.</p> <p>Des tests plus poussés sont recommandés dans le but d'approfondir l'effet des méthodes de déposition des agents de type II sur leur durée d'efficacité et de comparer le comportement de ces agents sur aile avec celui sur plaques planes.</p>						
17. Mots clés Avions, neige, bruine, pluie, antigivrage, agent, durée d'efficacité, précipitation, aile, plaque, dégivrage, glace, capteur, température, épaisseur				18. Diffusion Le Centre de développement des transports dispose d'un nombre limité d'exemplaires.		
19. Classification de sécurité (de cette publication) Non classifiée		20. Classification de sécurité (de cette page) Non classifiée		21. Déclassification (date) —	22. Nombre de pages xx, 90, ann.	23. Prix —

EXECUTIVE SUMMARY

At the request of the Dryden Commission Implementation Program of Transport Canada, APS Aviation Inc. (APS) undertook a study to develop a test program, conduct tests, and analyse results in order to compare the test data for the performance of fluids on flat plates (which has been used to substantiate the SAE/ISO Holdover Time Tables) with the performance of fluids on service aircraft.

As a result of a number of fatal aircraft accidents, aircraft ground de-icing has been the subject of concentrated industry attention over the past decade. Concentrated attention given to aircraft ground de-icing/anti-icing holdover times has led to the establishment of Holdover Time Tables and the development of new fluids designed specifically to extend holdover times. Test procedures to establish fluid holdover times have been adopted based on use of a standard flat plate.

The prime objective of this study was to address the validity of the flat plate test as representative of Type I and Type II fluid behaviour on service aircraft. Secondary objectives included examination of aspects of fluid failure on the aircraft such as point of first failure, subsequent failure progression, failure on the representative surface, effect of environmental conditions on failure time, and a better understanding of fluid thickness profile and wing temperature profile following de-icing.

Data Collection and Findings

A set of trials were designed involving simultaneous application of either Type I or Type II fluids on standard flat plates and aircraft wings in natural precipitation conditions. The standard flat plate test procedures used in holdover time trials were followed, and the aircraft was tested in a static position.

Simultaneous aircraft and flat plate tests were conducted at three locations:

- Toronto's Pearson International Airport, with tests conducted by Zephyr North, employing Canadian Airlines International B-737 aircraft and Type I (XL54) fluid;
- Montreal Dorval Airport, with tests conducted by APS Aviation Inc., employing Air Canada DC-9 aircraft and Type I (XL54) and Type II Union Carbide (Ultra) fluid; and

- St. John's International Airport, with tests conducted by Instrumar Limited, employing Air Canada DC-9 and Air Atlantic BAE-146 aircraft and limited to Type I (XL54) fluid.

A total of thirty-nine (39) tests were conducted at these locations: nine at Dorval; twenty-eight at St. John's; and two at Toronto. Lack of suitable weather for testing at Dorval and Toronto limited the number of tests at those locations and, thereby, on Ultra fluid. In addition to providing overnight aircraft (enabling testing from 23:00 to 06:00 hours), the airlines provided de-icing personnel, de-icing equipment and facilities.

Results and Conclusions

For Type I fluid, test results showed that flat plate holdover times (which are based on failure of the fluid over 33% of the plate surface) are equivalent to the time when 10% of the fluid on the entire wing has failed. These results confirm those observed by United Airlines during similar tests conducted in Denver during winter 1992/93. Flat plates have thus been shown to offer satisfactory representation of aircraft wing surfaces in holdover time trials for Type I fluids. Whether an acceptable level of visible fluid failure on the wing can be established is the subject of a separate test program to be conducted by the National Research Council (NRC).

Three tests were performed with the new Union Carbide Ultra Type II neat fluid, and in all cases the fluid failed on aircraft wings earlier than on flat plates. A number of potential causes associated with application procedures are believed to have contributed to this early failure:

- Use of a de-icing vehicle spray nozzle originally selected to spray Type I fluid;
- Delay between the application of Type I and Type II fluids, which may have permitted contamination of the Type I fluid;
- Inconsistent spraying of Ultra fluid, which produced uneven coverage over the wing, in particular at the leading edge; and
- The standard flat plate test procedure specifies that fluid be applied by pouring on the flat plates. This may not be representative of the spraying application on the wing.

These concerns evolved from observations during the actual tests and from subsequent analysis of test data when it was seen that results were clearly not what was expected. Preparation for future tests will need to ensure that the assigned de-icing vehicles are adequately equipped to spray Ultra fluid. Similarly, care must be taken in the spraying operation to produce complete and consistent coverage over the entire wing surface, and to ensure that inordinate delays between application of de-icing fluid and anti-icing fluid do not occur. The standard flat plate test procedure of applying Ultra fluid on plates by pouring versus spraying must be investigated to determine its potential influence on time to failure.

Observations of failure progression on the wing indicate that the trailing edge and the leading edge are the most failure sensitive regions, due to the presence of flight control surfaces and the fluid thinning effect of surface discontinuities. In addition, with the wing leading edge into the wind, the impact of wind-driven snow is highest on the leading edge, contributing further to early failure in this region.

Fluid failure was seen to progress from the point of first failure. In general, the trailing edge and leading edge failed first, followed by the mid-chord section.

The representative surface does not present itself as a conclusive representation of the condition of the aircraft wing surface, as earlier failure occurred elsewhere on the wing surface about 70% of the time for all tests. The events of earlier failure on the representative surface are related to the DC-9 aircraft having a small raised surface area within the representative surface area causing premature fluid thinning. Frequency of occurrence of first failure shows that the leading edge is a critical area. Because failure here has a very detrimental influence on lift, location of the representative surface on the wing leading edge should be considered.

During the tests it was seen that identification of fluid failures from inside the cabin was difficult, resulting in failure calls later than calls made by external observers.

During the take-off roll, Ultra fluid thickness recorded by AlliedSignal C/FIMS sensors installed in aircraft wings showed fluid thinning during acceleration, followed by a thicker layer of fluid and finally, during the rotation manoeuvre, the fluid thinned once more. None flowed off the wing during taxi.

Recommendations are to finalize validation of Ultra fluid performance on aircraft wings and to improve visibility of fluid failure from inside the cabin and the effectiveness of the representative surface.

SOMMAIRE

À la demande du Comité de mise en oeuvre de la Commission Dryden, Transports Canada, APS Aviation Inc. (APS) a lancé une étude visant à mettre au point un programme d'essais, à mener des essais, à en analyser les résultats et enfin à établir des comparaisons entre le comportement de différents agents de dégivrage/antigivrage sur plaque planes (qui ont servi à la vérification des tables de durée d'efficacité selon SAE/ISO) avec le comportement de ces mêmes agents sur les surfaces portantes d'avions réels.

La question du dégivrage des avions au sol a fait l'objet de nombreuses études au cours de la dernière décennie, et dont de nombreux accidents d'avions avec tués avaient montré la nécessité. Les études visant à approfondir les durées d'efficacité des divers agents de dégivrage/antigivrage ont mené à l'élaboration de tables sur les durées d'efficacité, d'une part, et à la mise au point de nouveaux agents permettant de prolonger ces durées, d'autre part. Les procédures adoptées pour la détermination des durées d'efficacité ont été fondées sur celles qui avaient été étudiées à l'égard des durées d'efficacité sur plaques planes.

La présente étude avait pour objectif principal de déterminer dans quelle mesure les résultats des essais sur plaques planes sont représentatifs du comportement des agents de type I et II dans des conditions réelles de service. La détermination des différents autres effets constatés une fois que ces agents cessaient d'être efficaces figurait parmi les objectifs secondaires fixés à la recherche, c'est-à-dire : moment exact où la cessation de l'efficacité était observée pour la première fois, propagation de cette cessation, cessation totale sur la surface de l'aile dite représentative, effets des conditions environnementales et meilleure connaissance du profil d'épaisseur de l'agent en fonction du profil thermique de l'aile à partir du moment où l'agent est déposé sur celle-ci.

Saisie de données et observations

Une série d'essais a été étudiée, pour laquelle il fallait déposer simultanément un agent de type I ou II sur des plaques planes normalisées et sur les ailes d'un avion dans des conditions de précipitation naturelle. À l'égard des plaques planes, les procédures utilisées ont été les mêmes que les procédures normalisées pour la détermination des durées d'efficacité. À l'égard des avions, la durée d'efficacité a été déterminée dans des conditions statiques.

Ces essais d'observation simultanée ont eu lieu aux trois endroits suivants :

- Aéroport international de Toronto, menés par Zephyr North avec un agent de type I (XL54) déposé sur un B-737 des Lignes aériennes Canadien International;
- Aéroport de Dorval à Montréal, menés par APS Aviation Inc. avec des agents de type I (XL54) et II (*Ultra* de Union Carbide) sur un DC-9 d'Air Canada;
- Aéroport international de St. John's, menés par Instrumar Limited avec un agent de type I (XL54) sur un DC-9 d'Air Canada et un BAE-146 d'Air Atlantic.

Au total, 39 tests ont été menés : 9 à Dorval, 28 à St. John's et 2 à Toronto. Des conditions météorologiques peu propices à Dorval et à Toronto ont réduit le nombre des essais et donc les essais avec l'*Ultra*. En plus de mettre à disposition leurs avions en vue des essais entre 23 h et 6 h le lendemain, les sociétés aériennes mentionnées ont fourni l'équipement de dégivrage, l'installation correspondante ainsi que le personnel nécessaire.

Résultats et conclusions

Avec l'agent de type I, les résultats montrent que les durées d'efficacité sur plaques planes (qui sont les valeurs retenues lorsque l'agent cesse d'être efficace pour 33 p.100 de la surface de chaque plaque) correspondent aux durées d'efficacité lorsque l'agent cesse d'être efficace pour 10 p. 100 d'une aile au complet. Ces résultats confirment les observations faites par United Airlines à la suite d'essais menés par cette compagnie à Denver durant l'hiver 1992-1993. On en conclut que les valeurs d'efficacité sur plaques planes sont représentatives dans une bonne mesure des durées d'efficacité de l'agent type I sur une aile d'avion, lorsque celle-ci est soumise à des essais normalisés. Quant à la possibilité de constater visuellement, par un procédé acceptable, le moment où un agent cesse d'être efficace, elle fait l'objet d'un programme d'essai séparé mené par le Conseil national de recherches (CNR).

Trois tests ont été menés avec le nouveau fluide type II de Union Carbide, appelé *Ultra*, et chaque fois, sa durée d'efficacité sur aile a été moindre que sur plaques planes. Cet écart peut être attribué à un certain nombre de causes probables liées à la méthode avec laquelle ce fluide est déposé sur l'aile :

- usage d'une lance destinée à l'arrosage d'un agent de type I à partir d'un véhicule de dégivrage;
- laps de temps entre l'arrosage avec l'agent de type II et l'arrosage avec un agent de type I, donnant ainsi l'occasion à ce dernier d'être contaminé;
- arrosage inégal de fluide *Ultra*, produisant des couches d'épaisseur inégale, surtout aux bords d'attaque;
- la procédure normalisée sur plaque plane est de verser l'agent, ce qui ne correspond pas à la procédure d'arrosage utilisée sur les ailes d'un avion.

Ces choses ont été mises en évidence à la lumière des observations faites et des analyses qui ont suivies, montrant que les résultats ne concordaient manifestement pas avec ceux qu'on attendait. Pour les tests à venir, il faudra veiller à ce que les véhicules d'arrosage avec le fluide *Ultra* soient convenablement équipés, à ce que l'arrosage recouvre complètement et également toute la surface de l'aile et à ce qu'il n'y ait pas de retard indu entre les arrosages successifs. La méthode de verser le fluide *Ultra* par opposition à celle de l'arroser devra être approfondie quant à l'effet qu'elle peut produire sur la durée d'efficacité de ce fluide.

Les observations concernant la propagation de la cessation d'efficacité montrent que les parties de l'aile les plus sensibles sont les bords d'attaque et de fuite, à cause de la présence des gouvernes et d'irrégularités géométriques qui causent des inégalités dans les épaisseurs d'arrosage. De plus, lorsque le bord d'attaque fait face au vent, l'effet de la neige poussée par le vent se fait sentir avec plus de force, contribuant à une dégradation encore plus rapide de l'agent dans cette zone.

Il a été observé que la dégradation de l'agent se propage à partir du point où elle se manifeste pour la première fois, et que les zones touchées sont d'abord les bords d'attaque et de fuite, suivies de la zone s'étendant tout le long de l'aile en sa partie médiane.

Le tronçon de l'aile appelé représentatif ne peut être considéré comme indicatif de l'état où se trouvent les autres parties de l'aile, étant donné que la dégradation avait commencé plus tôt ailleurs que

sur ce tronçon, et ce pour quelque 70 p. 100 des tests. Les cas où la dégradation avait commencé dans ce tronçon plus tôt qu'ailleurs correspondent au DC-9 qui a la particularité de présenter une petite saillie dans ce tronçon, causant un amincissement de la couche de fluide qui y est déposée. La fréquence des cas de première manifestation de dégradation montre que le bord d'attaque est la zone la plus vulnérable. Étant donné qu'une dégradation dans ce tronçon peut avoir une influence défavorable sur la portance, il serait bon que le tronçon défini comme représentatif soit repéré sur le bord d'attaque.

Les tests ont montré aussi que l'observation du moment exact où la dégradation commençait était plus difficile de l'intérieur de la cabine que de l'extérieur.

Les capteurs C/FIMS d'Allied Signal encastrés dans les ailes montrent que, durant la phase précédant le décollage, le fluide *Ultra* perd de son épaisseur durant l'accélération, que cette épaisseur augmente ensuite pour s'amincir de nouveau au moment du cabrage, mais qu'aucune perte de fluide n'est observée durant le roulement au sol.

Des recommandations sont formulées concernant la validation du comportement du fluide *Ultra* déposé sur les ailes et visant à permettre de mieux visualiser la dégradation du fluide de l'intérieur de la cabine, de façon à pouvoir déduire l'état de l'aile à partir de l'état du tronçon défini comme représentatif.

TABLE OF CONTENTS

<u>SECTION NUMBER</u>		<u>PAGE NUMBER</u>
1.	INTRODUCTION	1
1.1	Objectives	2
2.	SIMULTANEOUS AIRCRAFT AND FLAT PLATE TESTS	5
2.1	Test Sites and Equipment	5
2.2	Personnel	8
2.3	Procedures	9
2.4	Data Presentation	16
2.5	Aircraft Wing Fluid Failure Analysis	21
2.5.1	Wing Grid Structure	21
2.5.2	Wing Failure Analysis	23
2.5.3	Inside Observer vs Outside Observer Failure Calls	31
2.5.4	First and 10% Fluid Failure Occurrence on Representative Surface Compared to Leading Edge, Trailing Edge or Mid-Wing.	31
2.6	Wing Failure vs Flat Plates Failure for Type I XL54 De-icing Fluid	35
2.6.1	Type I XL54 at Room Temperature Condition	35
2.6.2	Effects of Heated Type I Fluid	41
2.7	Analysis of Ultra Fluid Behaviour on a Wing	43
2.8	Aircraft Fluid Failure Times vs Weather Conditions	48
2.8.1	Analysis of the Influence of Rate of Precipitation on the Aircraft Failure Times	48
2.8.2	Influence of Outside Air Temperature on Aircraft Failure Times	48
2.8.3	Influence of Wind Speed on Aircraft Failure Times	48
2.9	Observations on Test Procedures	52
3.	FLUID THICKNESS DURING TAKE-OFF	53
3.1	Procedures	53
3.2	Test Results	54
3.3	Observations	58
4.	TEMPERATURE HISTORY	61
4.1	Testing Occasions	73
4.1.1	Air Atlantic (1995) Limited Full-Scale Test	73
4.1.2	Mirabel Airport Full-Scale Test	74
4.1.3	Mirabel Airport Fluid Thickness Test	74
4.1.4	Pearson International Airport Full-Scale Test Feb 21, 1995	76
4.1.5	Pearson International Airport Full-Scale Tests March 26,1995	76
4.1.6	Marquette Michigan Full-Scale Test	77
4.1.7	Dorval Airport Full-Scale Tests	77
4.2	Temperature History Analysis	78

TABLE OF CONTENTS

<u>SECTION NUMBER</u>		<u>PAGE NUMBER</u>
5.	CONCLUSIONS	81
5.1	Correlation of Fluid Failure Times between Aircraft Surfaces and Flat Plates	81
5.2	Failure Progression on the Wing	83
5.3	Adequacy of the Representative Surface and Visibility of Wing Contamination from Inside the Cabin	84
5.4	Impact of Environmental Conditions on Fluid Failure Times	85
5.5	Fluid Thickness Profile During Take-Off and Roll	85
5.6	Wing Temperature Profiles During De-Icing	86
5.7	General Observations on Test Procedure	87
6.	RECOMMENDATIONS FOR FUTURE TESTING	89

APPENDIX

APPENDIX A	APS TEST PROCEDURES
APPENDIX B	INSTRUMAR TEST PROCEDURES
APPENDIX C	DETAILED AIRCRAFT VS FLAT PLATE TEST RESULTS
APPENDIX D	DETAILS OF THE AIRCRAFT WING TEMPERATURE MEASUREMENTS DURING STATIC TESTS AT ST. JOHN'S, NEWFOUNDLAND
APPENDIX E	TERMS OF REFERENCE - WORK STATEMENT

FIGURE NUMBER		PAGE NUMBER
Figure 2.1	Position of Equipment and Personnel	6
Figure 2.2	Type I Fluid Application	10
Figure 2.3	Type II Fluid Application	11
Figure 2.4	Sample of the Comparison of End Condition Times from the DC-9 Wing Observer and Flat Plate Observer	17
Figure 2.5	Sample Comparison of End Condition Times from the Aircraft Wing Observer and Flat Plate Observer	18
Figure 2.6	De/Anti-Icing Form For Aircraft Wing	22
Figure 2.7	Failure Time Progression For a Type I Test	30
Figure 2.8	Aircraft 1st Failure vs. Plates V and Y Failure	36
Figure 2.9	Aircraft 10% of LE/TE/M Failure vs. Plates V and Y Failure	37
Figure 2.10	Aircraft 25% of LE/TE/M Failure vs. Plates V and Y Failure	38
Figure 2.11	Comparison of Plate Failure Time of Room Temperature XL54 vs Heated XL54 From Truck	42
Figure 2.12	Effect of Fluid Type and Rate of Precipitation on Type II Neat Fluid Failure Time in Natural Snow Conditions	44
Figure 2.13	Comparison of End Condition Times from the DC-9 Wing Observer and Flat Plate Observer	46
Figure 2.14	Aircraft 1st Failure vs. Rate of Precipitation	49
Figure 2.15	Aircraft 10% of LE/TE/M vs. Rate of Precipitation	50
Figure 2.16	Aircraft 25% of LE/TE/M vs. Rate of Precipitation	51
Figure 3.1	Fluid Thickness Roll-off at Mirabel: Right Wing	55
Figure 3.2	Fluid Thickness Roll-off at Mirabel: Right Wing during Take-off Run	55
Figure 3.3	Fluid Thickness Roll-off at Mirabel: Left Wing	56
Figure 3.4	Fluid Thickness Roll-off at Mirabel: Left Wing during Take-off Run	56
Figure 3.5	Fluid Thickness Roll-off Comparison between Left and Right Wing	57
Figure 3.6	Fluid Thickness Roll-off Comparison between Left and Right Wing during Take-off Run	57
Figure 4.1	Temperature Profile: Air Atlantic (1995) Limited Test 1a	62
Figure 4.2	Temperature Profile: Air Atlantic (1995) Limited Test 1b	62
Figure 4.3	Temperature Profile: Air Atlantic (1995) Limited Test 1c	63
Figure 4.4	Temperature Profile: Mirabel Airport Static Test 1a Type I followed by Artificial Freezing Rain	63
Figure 4.5	Temperature Profile: Mirabel Airport Static Test 1b Type I, then Type II followed by Artificial Freezing Rain	64
Figure 4.6	Temperature Profile: Mirabel Fluid Thickness Test	64
Figure 4.7	Temperature Profile: Pearson International Airport Static Test 1a	65
Figure 4.8	Temperature Profile: Pearson International Airport Static Test 1b	65
Figure 4.9	Temperature Profile: Marquette Michigan Static Test 1a	66
Figure 4.10	Temperature Profile: Marquette Michigan Static Test 1b	66
Figure 4.11	Full-Scale Temperature Measurement Test at YUL	67
Figure 4.12	Full-Scale Temperature Measurement Test at YUL	68
Figure 4.13	Full-Scale Temperature Measurement Test at YUL	69
Figure 4.14	Full-Scale Temperature Measurement Test at YUL	70
Figure 4.15	Full-Scale Temperature Measurement Test at YYZ	71
Figure 4.16	Full-Scale Temperature Measurement Test at YYZ	72

LIST OF FIGURES

<u>TABLE NUMBER</u>		<u>PAGE NUMBER</u>
Table 2.1	Listing of Full-Scale Tests Conducted in 1994/95	14
Table 2.2	Time and Location of Wing and Representative Surface First Failure and 10% Failure	24
Table 2.3	Summary of Tally of First and 10% Failure Locations Relative to Wind Direction	26
Table 2.4	Comparison of Inside Observer and Outside Observer Failure Call Times (Minutes)	32
Table 2.5	Count of Earlier and Simultaneous Occurrence of Failure on the Representative Surface or LE, TE or M	33

<u>PHOTOS NUMBER</u>		<u>PAGE NUMBER</u>
Photo 2.1	General Set-Up of Equipment at Toronto	7
Photo 2.2	Failure Occurrence on Control Surface Trailing Edge of B-737	13

LIST OF ACRONYMS

AES	Atmospheric Environment Services (Canada)
APS	APS Aviation Inc.
CASP	Canadian Atlantic Storms Program
CEF	Climatic Engineering Facility
C/FIMS	Contaminant/Fluid Integrity Monitoring System
CWDS	Clean Wing Detection System
DCIP	Dryden Commission Implementation Project
DNF	Did Not Fail
FAA	Federal Aviation Administration (USA)
LE	Leading Edge
M	Mid-Wing
NIC	Not In Contract
NRC	National Research Council
READAC	Remote Environmental Automatic Data Acquisition Concept
RVSI	Robotic Vision Systems Inc.
SAE	Society of Automotive Engineers
TDC	Transportation Development Centre
TE	Trailing Edge
UCAR	Union Carbide
YUL	Montreal Dorval Airport
YYT	St. John's International Airport
YYZ	Toronto Pearson International Airport

Weather Acronyms

FPD	Freezing Point Depressant
FZD	Freezing Drizzle
FZR	Freezing Rain
IP	Ice Pellets
SG	Snow Grain

This page intentionally left blank.

1. INTRODUCTION

1.1 Objectives

1. INTRODUCTION

1. INTRODUCTION

Aircraft ground de-icing has been the subject of concentrated industry attention over the past decade as a result of a number of fatal aircraft accidents. Much of this attention has been given to the abilities of de-icing fluids to provide an extended duration of protection against further snow or ice build up following initial de-icing. This has led to the development of fluid holdover time tables for use by aircraft operators and accepted by regulatory authorities. As well, new improved fluids have been developed with the specific objective of extending holdover times without impacting upon aerodynamic characteristics of the airfoil.

The process of developing and substantiating these holdover time tables for existing fluids and new fluids as they have become available, has taken the form of tests, both in the field during natural precipitation conditions and in laboratory situations, utilizing inclined flat plates. Test procedures to measure duration of fluid de-icing protection have evolved to a standard approach that has been followed by APS and others at a number of different locations in previous years.

The result of intensive testing has been the acceptance of much increased holdover durations for new generation fluids, and general recognition of the holdover time limitations of the older Type I fluids. Although the flat plate test procedures have become quite sophisticated over the past few years, test results have not yet been thoroughly correlated against results using full-scale aircraft wings and the flat plate has not yet been fully validated as an adequate representation of the airfoil.

To determine correlation, a set of simultaneous trials were designed involving the standardized flat plate tests together with actual aircraft in natural precipitation conditions. Both Type I and Type II fluids were employed in the trials.

1. INTRODUCTION

1.1 Objectives

The primary aims of the study were (see Appendix E for detailed statement of work):

1. to compare fluid failure times between flat plates and aircraft wing surfaces under conditions of natural freezing precipitation; and
2. to identify the location of first point of fluid failure on the wing and subsequent failure progression.

Secondary objectives included:

3. to identify the behaviour of fluid on the aircraft representative surface in comparison to the rest of the wing; and
4. to compare fluid failure time with weather conditions.

Instrumar Limited and AlliedSignal, developers of the Contaminant/Fluid Integrity Monitoring System (C/FIMS), were assigned two further objectives utilizing aircraft already equipped with this instrumentation:

5. to provide data on fluid thickness profile during take-off roll; and
6. to provide data on wing temperature profile during/following de-icing operation.

1. INTRODUCTION

A total of thirty-nine (39) simultaneous aircraft/flat plate tests were conducted at three locations; nine at Dorval, twenty-eight at St. John's and two at Toronto. Tests at St. John's were restricted to Type I fluid because of de-icing truck limitations. Tests at Dorval and Toronto where both Type I and Type II could be tested were limited in number due to lack of snow conditions. In addition to providing overnight aircraft (enabling testing from 23:00 to 06:00 hours) the airlines provided de-icing personnel, de-icing equipment and facilities. Type I and Type II fluids in a pre-sheared condition were provided by Union Carbide.

A single fluid thickness test was conducted at Montreal Mirabel Airport. Temperature history profiles were recorded during de-icing events at St. John's Airport, Mirabel Airport, Dorval Airport, Pearson International Airport, and Marquette Michigan.

This report is presented in six parts, with Part 1 being the general introduction. Part 2 addresses the primary aim of comparing fluid performance on flat plates to performance on aircraft wing surfaces, as defined by objectives one to four, Part 3 addresses objective five (fluid thickness profile), and Part 4 addresses objective six, wing temperature profile resulting from de-icing. Parts 5 and 6 present conclusions and recommendations.

This report is submitted as part of the contract deliverables by APS Aviation Inc. to the Dryden Commission Implementation Project (DCIP). The report covers all data collected by Instrumar, Zephyr North and APS Aviation for the 1994/95 winter full-scale testing operations.

This page intentionally left blank.

2. SIMULTANEOUS AIRCRAFT AND FLAT PLATE TESTS

2.1 Test Sites and Equipment

2.2 Personnel

2.3 Procedures

2.4 Data Presentation

2.5 Aircraft Wing Fluid Failure Analysis

2.6 Wing Failure vs Flat Plates Failure for Type I XL54 De-icing Fluid

2.7 Analysis of Ultra Fluid Behaviour on a Wing

2.8 Aircraft Fluid Failure Times vs Weather Conditions

2.9 Observations on Test Procedures

2. SIMULTANEOUS AIRCRAFT AND FLAT PLATE TESTS

2. SIMULTANEOUS AIRCRAFT AND FLAT PLATE TESTS

The full-scale tests conducted in 1994/95 evolved from the collaborative efforts of APS, Instrumar, the Dryden Commission Implementation Project (DCIP), Zephyr North, the participating airlines, and Union Carbide (UCAR).

2.1 Test Sites and Equipment

Simultaneous aircraft/flat plate tests were conducted at three locations:

- Toronto Pearson International Airport (YYZ) by Zephyr North, employing Canadian Airlines International aircraft;
- Montreal Dorval Airport (YUL) by APS Aviation Inc., employing Air Canada aircraft; and
- St. John's International Airport (YYT) by Instrumar Limited, employing Air Canada and Air Atlantic aircraft.

Test equipment for the Dorval and Toronto aircraft full-scale testing program is given in Appendix A Attachment II "Test Equipment Checklist", and in Figure 2.1. Photo 2.1 shows the equipment set-up at YYZ prior to a test on the starboard wing. A motor home was leased to service the test site for Toronto tests and a trailer was used for the Dorval tests. Other significant equipment included aircraft stands, C/FIMS detection sensors, RVSI contamination detection sensors, video cameras, and lighting.

**FIGURE 2.1
POSITION OF EQUIPMENT AND PERSONNEL**

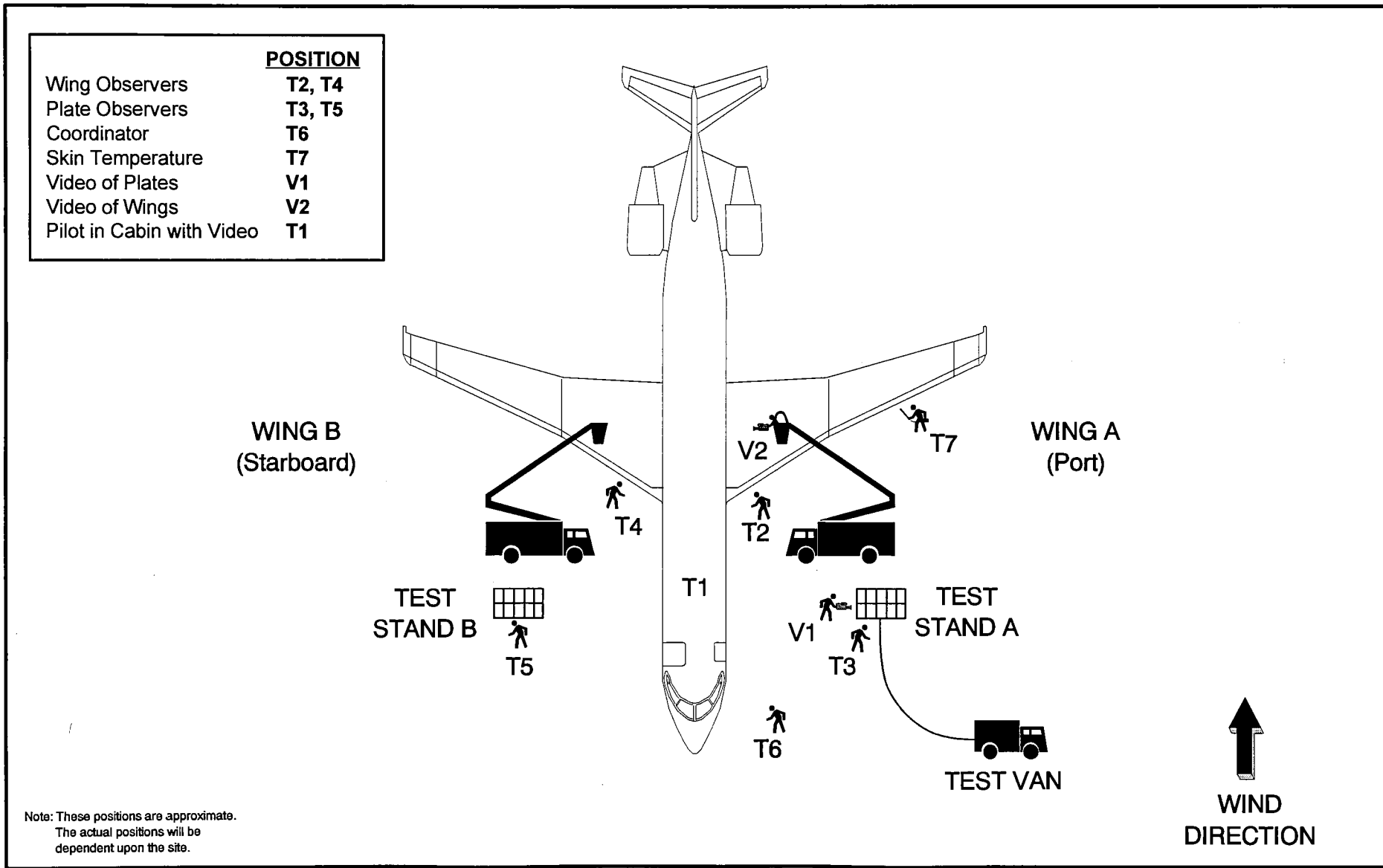

9

PHOTO 2.1
GENERAL SET-UP OF EQUIPMENT AT TORONTO

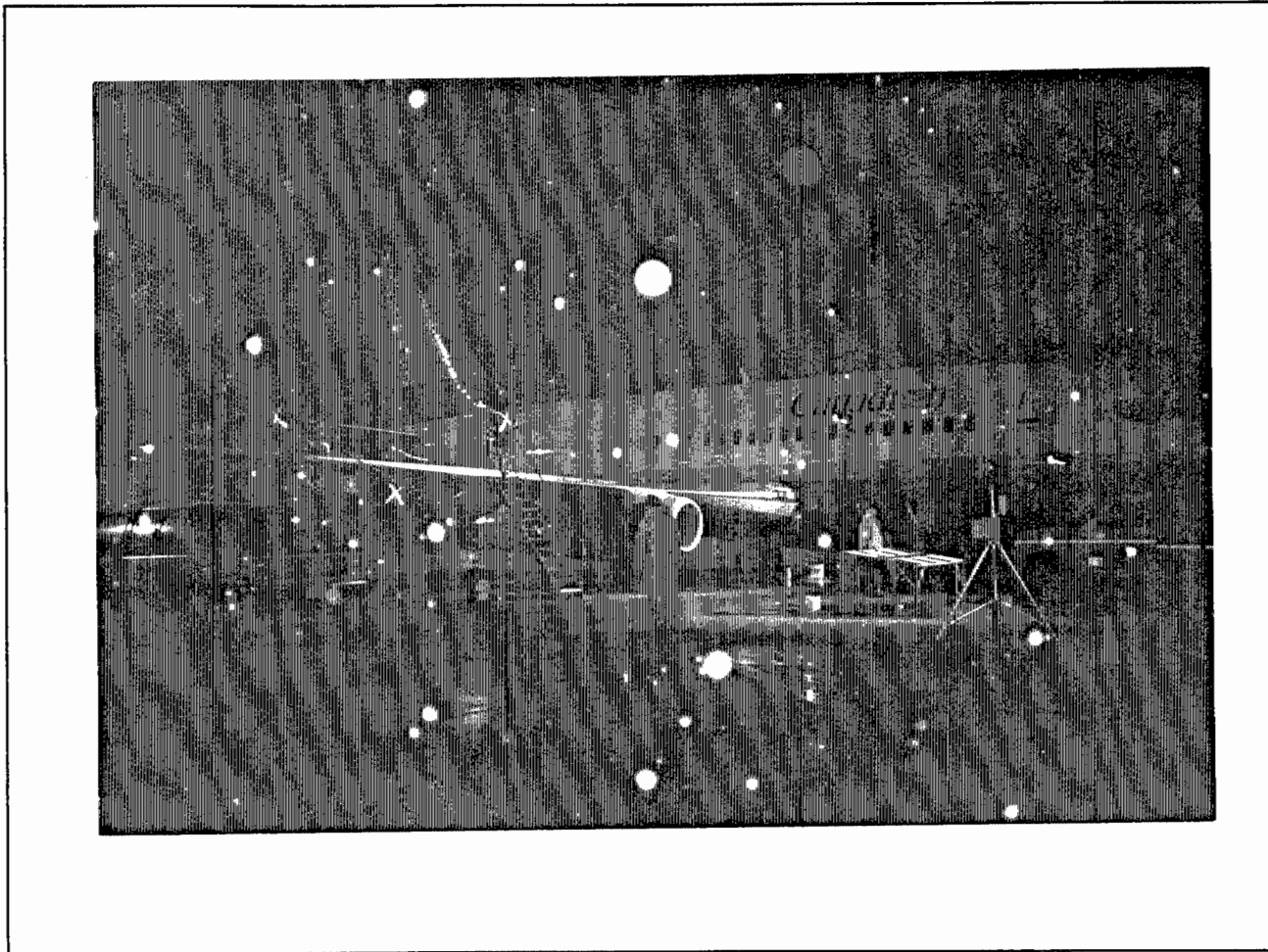

2. SIMULTANEOUS AIRCRAFT AND FLAT PLATE TESTS

2.2 Personnel

Up to nine people were required to conduct each test at Dorval, Toronto and St. John's. Figure 2.1 provides a schematic description of the general test set-up as well as the location of the nine testers for the Dorval and Toronto sites. It is worth noting that two of the testers were dedicated video personnel (V1 and V2) taking video records of the tests. Position T1 was usually manned by a pilot, who also recorded video from inside the aircraft cabin. A mobile aircraft wing observer was assigned during the Dorval and Toronto tests, moving in a pattern about the wing and accessing the wing via four stands pre-positioned at the leading and trailing edges. The St John's tests involved two observers per wing in fixed positions on stands at the leading edge. Appendix A Attachment III "Responsibilities/Duties of Test Personnel" and Appendix B Section 3 "Responsibility Details" contain more accurate descriptions of the testers responsibilities, individual duties and positions.

2.3 Procedures

The APS documents "Experimental Program for Simultaneous Aircraft vs Plate Testing" and "Experimental Program for Dorval Natural Precipitation Flat Plate Testing" as well as the Instrumar document "Ground Static Test Plan and Procedure" are provided in Appendices A and B, respectively. These describe the detailed procedures employed.

Figures 2.2 and 2.3 provide schematic descriptions of the simultaneous aircraft and flat plate fluid application procedures for Type I and Type II fluids, respectively.

Test procedures for the two types of fluids are similar. The fluid applied on plates U and X was obtained by spraying fluid from the de-icing truck into a pail, and thereafter pouring the fluid on these plates concurrently with the wing application. Fluids applied on the other plates were taken from the Dorval test site fluid supplies. These included Type I standard fluid (V and Y) and Type I fluid diluted to a 10°C buffer (W and Z) at room temperature or Type II fluid neat (V, W, Y and Z) at outside air temperature. Type II fluid for these tests was delivered in a condition corresponding to fluid pumped from a de-icing vehicle (referred to as "pre-sheared" condition). Fluid application procedures for plates V, W, Y and Z adhered to standard flat plate test procedures. Fluid application on these plates followed the application on plates U and X and was concurrent with wing spraying except for Type II tests when plates W and Z had fluid applied after the wing was completed. Fluid application start times for all plate pairs (U and X, V and Y, W and Z) were recorded. The wing skin temperature measurements were taken before fluid application and at noted intervals after fluid application.

FIGURE 2.2 STEPS REQUIRED FOR TYPE I FLUID APPLICATION

- Step 1: Spray heated XL54 fluid from cherry picker into pail.
- Step 2: Apply XL54 onto the aircraft wing (Start of HOT)
- Step 3: Apply XL54 onto plates U and X from the pail.
- Step 4: Apply ambient (room temperature) XL54 onto plates V and Y.
- Step 5: Apply diluted XL54 onto plates W and Z.

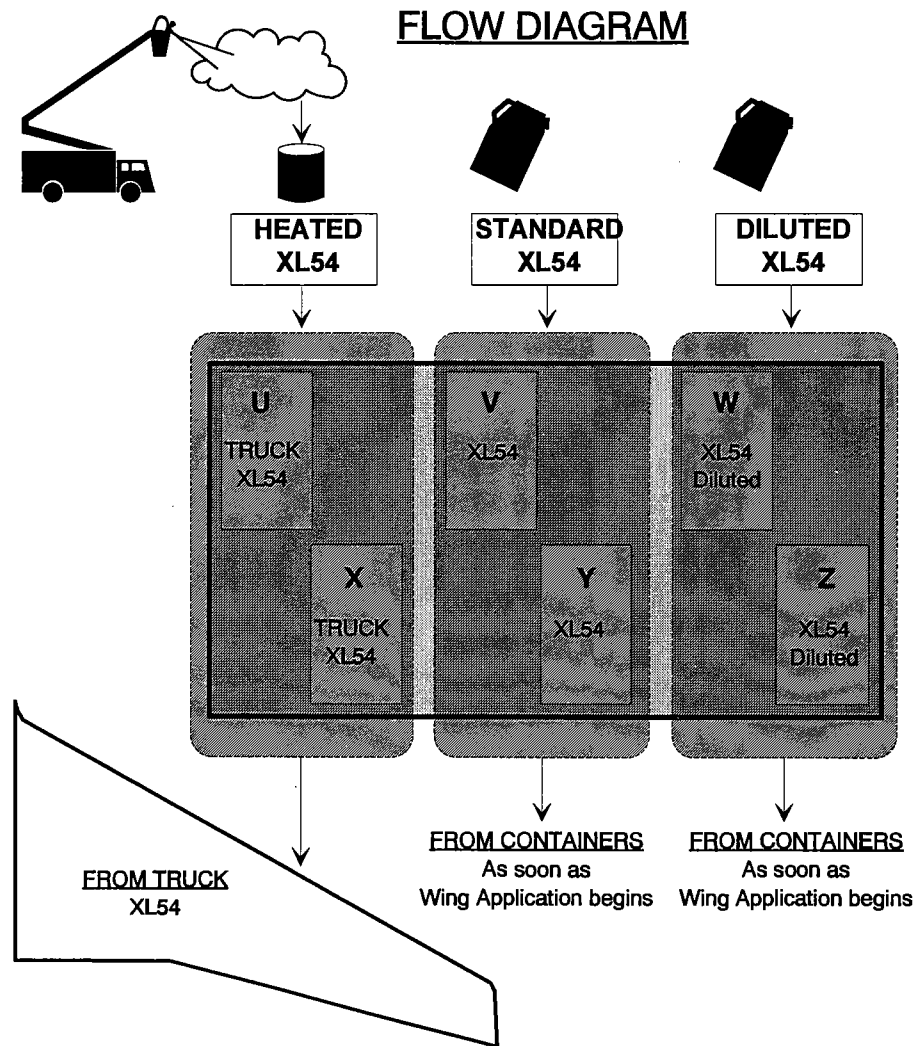
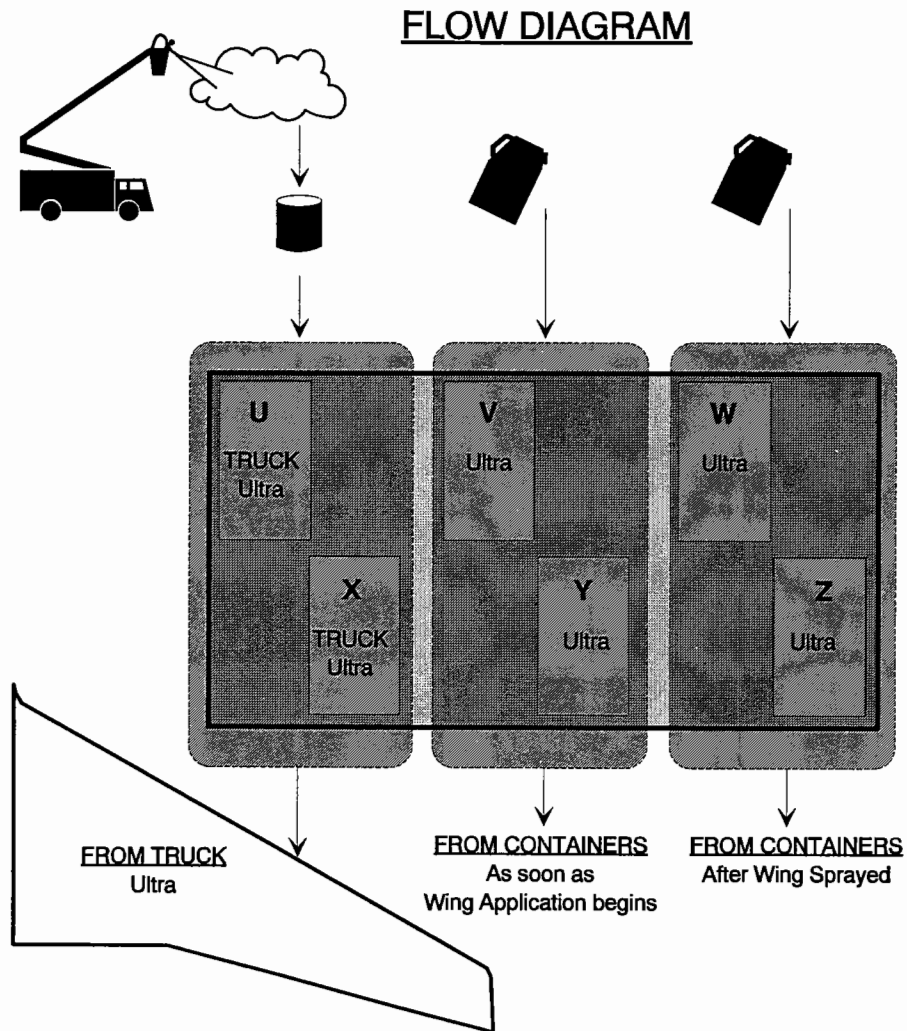

FIGURE 2.3 STEPS REQUIRED FOR TYPE II FLUID APPLICATION

- Step 1: Repeat Step 1 to 3 from Type I application.
- Step 2: Apply Type II fluid onto the aircraft wing (Start of HOT).
- Step 3: Apply the truck Ultra Type II onto plates U and X from the pail.
- Step 4: Apply Ultra Type II fluid onto plates V and Y at the same time that the wing application starts.
- Step 5: Apply Type II fluid onto plates W and Z when the wing application is completed.



2. SIMULTANEOUS AIRCRAFT AND FLAT PLATE TESTS

To simplify reference, the plate sets will hereafter be referred to as follows:

	For Type I	For Type II
Plates U and X:	Truck fluid plates	Truck fluid plates
Plates V and Y:	Standard fluid plates	Standard fluid plates - concurrent
Plates W and Z:	Diluted fluid plates	Standard fluid plates - after wing

The failure time is the time required for the end condition (see Flat Plate Test Procedure in Appendix A) to be achieved. On a plate, this occurs when precipitation fails to be absorbed at five of the fifteen crosshair marks on the panels. Photo 2.2 shows typical failure on the trailing edge of a B-737 aircraft.

A Contaminant/Fluid Integrity Measurement Sensor (C/FIMS) was installed on one of the flat plates. Each simultaneous test commenced by de-icing the right wing and the plates of the right stand which was placed in front of the wing for comparison purposes. In many cases, testing on the left wing and left stand plates was possible after the right wing test was started. Each side of the aircraft had its own team.

Although the description of test procedure details varies between St. John's and the other locations, all procedures were based on the common requirement to identify fluid failure times on the plates and the wing during simultaneous tests.

Table 2.1 provides a listing of the full-scale tests conducted in 1994/95. A total of thirty-nine tests were conducted:

- 9 tests in YUL by APS (L1 TO L9);
- 28 tests in YYT by Instrumar (T1 to T14); and
- 2 tests in YYZ by Zephyr North (Z1, Z2).

PHOTO 2.2
FAILURE OCCURRENCE ON CONTROL SURFACE
TRAILING EDGE OF B-737

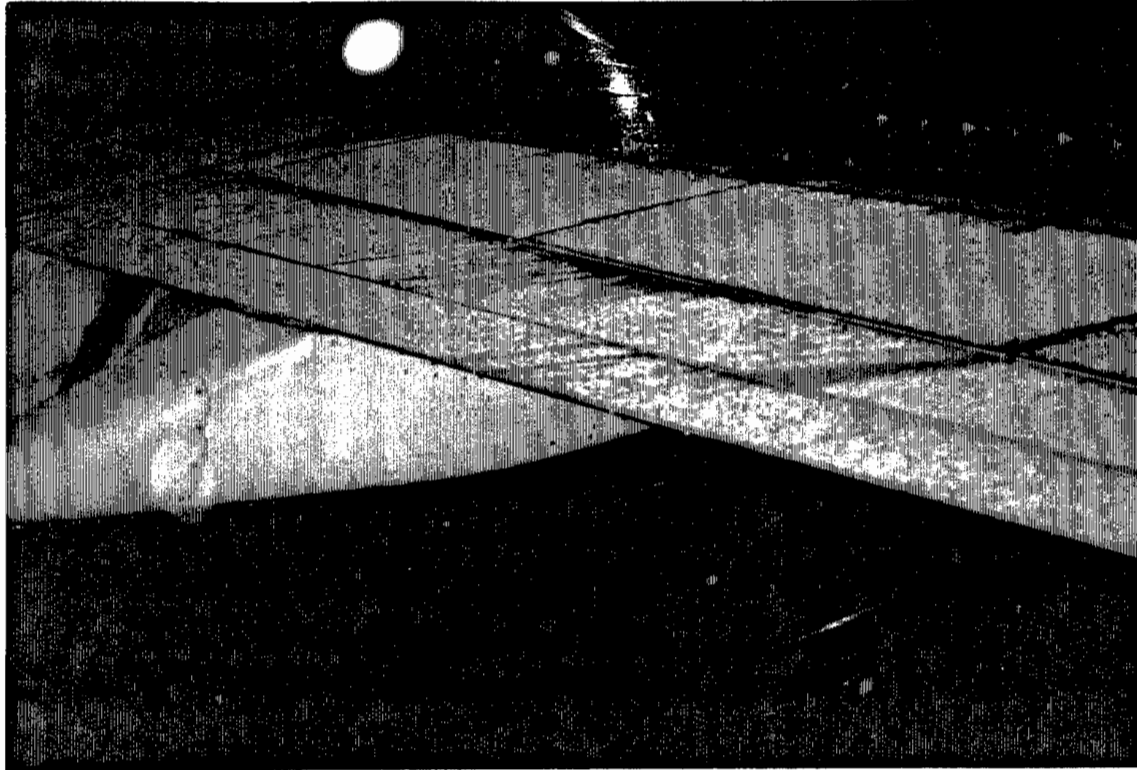

TABLE 2.1

LISTING OF FULL-SCALE TESTS CONDUCTED IN 1994/95

ID #	Test Location	date	run no.	A/C Type	A/C Wing	fluid name	Air Temp (°C)	Precip. Rate (g/dm²/hr)	Wind Head/Tail/Cross	Wind direct. (deg.)	Wind Speed (kph)	HOT Start Time	HOT End Time	a/c Orient. (E of N) (deg.)	Plate Avg. Fail U&X (min)	Plate Avg. Fail V&Y (min)	Aircraft Failure*			Precip. Type
																	1st Fail LE/TE (min)	10% LE/TE (min)	25% LE/TE (min)	
L1	YUL	Feb-24-95	1	DC-9	Strbd	70/30/XL54	0	11	cross	47	2	00:06	00:29	105	11	12	9	12	14	S
L2	YUL	Mar-06-95	1	DC-9	Strbd	XL54	-7	21	head	36	15	00:44	01:04	63	13	15	8	10	12	S
L3	YUL	Mar-06-95	3	DC-9	Port	XL54/Ultra	-7	17	head	36	14	02:27	03:44	63	64	59	9	12	15	S
L4	YUL	Mar-06-95	4	DC-9	Strbd	XL54	-7	7	head	36	14	03:58	04:30	63	16	16	14	23	25	S
L5	YUL	Mar-06-95	5	DC-9	Port	XL54	-7	6	head	32	10	04:47	05:19	63	20	18	8	12	16	S
L6	YUL	Mar-08-95	1	DC-9	Strbd	Ultra (hot)	-6	12	head	13	8	23:37	02:49	17	130	83	30	50	58	S
L7	YUL	Mar-09-95	2	DC-9	Port	XL54/Ultra	-7	9	head	344	8	01:52	03:40	17	100	89	20	24	64	S
L8	YUL	Mar-09-95	3	DC-9	Strbd	XL54	-7	9	cross	324	12	02:35	02:59	17	16	14	8	11	13	S
L9	YUL	Mar-09-95	4	DC-9	Strbd	XL54	-7	6	cross	326	9	03:44	04:06	17	11	11	10	12	13	S
T1	YYT	Feb-23-95	1	DC-9	Port	XL54	-6	void	cross	40	31	01:23	02:23	350	7	6	10	10	11	ZL/S
T1	YYT	Feb-23-95	2	DC-9	Strbd	XL54	-6	void	cross	40	31	01:23	02:23	350	9	8	7	12	16	ZL/S
T2	YYT	Feb-23-95	3	DC-9	Port	XL54	-7	void	cross	30	24	02:57	04:03	350	20	16	9	12	16	ZL/S
T2	YYT	Feb-23-95	4	DC-9	Strbd	XL54	-7	void	cross	30	24	02:57	04:03	350	27	26	11	17	32	ZL/S
T3	YYT	Mar-01-95	1	DC-9	Port	XL54	-5	7	head	60	28	00:45	01:20	80	14	11	7	7	14	S
T3	YYT	Mar-01-95	2	DC-9	Strbd	XL54	-5	7	head	60	28	00:45	01:20	80	12	9	7	9	11	S
T4	YYT	Mar-01-95	3	DC-9	Port	XL54	-6	15	head	60	26	02:23	02:55	80	13	11	7	8	10	S
T4	YYT	Mar-01-95	4	DC-9	Strbd	XL54	-6	15	head	60	26	02:23	02:55	80	13	11	6	8	10	S
T5	YYT	Mar-01-95	5	DC-9	Port	XL54	-7	17	head	60	24	03:34	04:00	80	11	10	8	8	9	S
T5	YYT	Mar-01-95	6	DC-9	Strbd	XL54	-7	17	head	60	24	03:34	04:00	80	13	12	6	11	13	SG
T6	YYT	Mar-08-95	1	DC-9	Port	XL54	-6	12	head	120	9	02:18	02:43	110	void	void	7	7	8	SG
T6	YYT	Mar-08-95	2	DC-9	Strbd	XL54	-6	12	head	120	9	02:18	02:43	110	16	7	9	11	12	IP
T7	YYT	Mar-08-95	3	DC-9	Port	XL54	-6	26	head	110	5	03:11	03:21	110	6	6	3	4	4	IP
T7	YYT	Mar-08-95	4	DC-9	Strbd	XL54	-6	26	head	110	5	03:11	03:21	110	6	4	3	4	5	ZR/S
T8	YYT	Mar-08-95	5	DC-9	Port	XL54	-5	23	head	120	5	03:45	03:55	110	8	11	3	3	3	ZR/S
T8	YYT	Mar-08-95	6	DC-9	Strbd	XL54	-5	23	head	120	5	03:45	03:55	110	5	3	3	4	4	S/P
T9	YYT	Mar-08-95	7	DC-9	Port	XL54	-5	10	head	120	6	04:18	04:33	110	15	16	4	5	7	S/P
T9	YYT	Mar-08-95	8	DC-9	Strbd	XL54	-5	10	head	120	6	04:18	04:33	110	9	6	4	5	6	ZR/ZL
T10	YYT	Mar-15-95	1	BAe-146	Port	XL54	-1	16	cross	80	37	01:23	02:53	35	23	23	void	void	void	ZL-F
T10	YYT	Mar-15-95	2	BAe-146	Strbd	XL54	-1	16	cross	80	37	01:23	02:53	35	18	15	void	void	void	ZL-F
T11	YYT	Mar-15-95	3	BAe-146	Port	XL54	-2	22	head	70	37	03:05	03:55	35	14	12	10	12	15	ZL-F
T11	YYT	Mar-15-95	4	BAe-146	Strbd	XL54	-2	22	head	70	37	03:05	03:55	35	19	13	void	void	void	ZL-F
T12	YYT	Apr-27-95	5	DC-9	Port	XL54	0	31	tail	330	35	01:47	02:22	190	14	12	6	6	8	L/F/S
T12	YYT	Apr-27-95	5	DC-9	Strbd	XL54	0	31	tail	330	35	01:47	02:22	190	2	2	void	9	10	L/F/S
T13	YYT	Apr-27-95	5	A320	Port	XL54	0	void	tail	330	37	03:10	04:30	190	void	void	void	void	void	L/F/S
T13	YYT	Apr-27-95	5	A320	Strbd	XL54	0	void	tail	330	37	03:10	04:30	190	void	void	void	void	void	L/F/S
T14	YYT	Apr-27-95	5	A320	Port	XL54	0	5	tail	330	39	04:39	05:21	190	5	5	9	9	14	L/F/S
T14	YYT	Apr-27-95	5	A320	Strbd	XL54	0	5	tail	330	39	04:39	05:21	190	26	26	10	20	25	L/F/S
Z1	YYZ	Feb-21-95	1	B-737	Strbd	XL54	0	17	head	347	4	00:48	01:15	295	10	8	8	10	17	S
Z2	YYZ	Feb-21-95	2	B-737	Strbd	XL54	2	2	cross	50	4	02:14	03:24	295	99	99	23	24	70	S

* Failures called by outside observers (T2/T4)
Note: 99 designates a non failure

2. SIMULTANEOUS AIRCRAFT AND FLAT PLATE TESTS

The lower number of tests in Montreal and Toronto were a result of lack of suitable weather conditions.

The fluids, Type I XL54 (36 tests) and Type II Ultra (3 tests), were provided by Union Carbide. De-icing vehicle capabilities restricted tests on Type II Ultra at Montreal and Toronto.

Aircraft used were:

- Air Canada, DC-9 and A320;
- Canadian Airlines, B-737; and
- Air Atlantic, BAe-146.

The tests were conducted under snow and other freezing precipitation (FZD, FZR, IP, SG) conditions. The temperature varied from +2° C to -7° C. Rates of precipitation were measured with plate pans and ranged from 2 to 26 g/dm²/hr. The wind speed varied from 2 to 39 kph. Most of the tests were conducted with the wing leading edge into the wind, the exceptions being tests L8, L9, T1, T2, T6, T10 and Z2 which were conducted with a cross wind, and tests T12, T13 and T14 which were conducted with a tail wind. Wind shifts in tests L8, L9 and Z2 resulted in these cross-wind conditions, while for the other tests it was part of the procedures.

Table 2.1 contains a summary of relevant test information such as test number, date, location, aircraft type, wing side and fluid. All relevant meteorological measurements are included along with fluid failure data for the plates and the aircraft wings.

Video tape records were produced for all trials.

2.4 Data Presentation

Appendix C illustrates in bar chart form the relationship between fluid failure and the various observation sites located on the aircraft wings and the six flat plates.

Results of APS tests are presented in a three-dimensional format in Appendix C. Figure 2.4 presents in two-dimensional format the results of the second (#L2) APS test on the starboard side of the aircraft. Figure 2.5 presents a sample of results from an Instrumar test on the starboard side of the aircraft.

The Instrumar bar charts present wing test results in two sections, (the outer wing and the inner wing), while APS test results report on the entire wing.

The following codes apply to the bar charts for tests at St. John's (YYT) Figure 2.5, and Appendix C pages C12 to C39.

1. L - Leading edge of aircraft wing;
2. M - Middle section of aircraft wing;
3. T - Trailing edge of aircraft wing;
4. R - Representative surface of aircraft wing;
5. U - Flat Plate U;
6. X - Flat Plate X;
7. V - Flat Plate V;
8. Y - Flat Plate Y;
9. W - Flat Plate W; and
10. Z - Flat Plate Z.

FIGURE 2.4
SAMPLE OF THE COMPARISON OF END CONDITION TIMES
FROM THE DC-9 WING OBSERVER AND FLAT PLATE OBSERVER

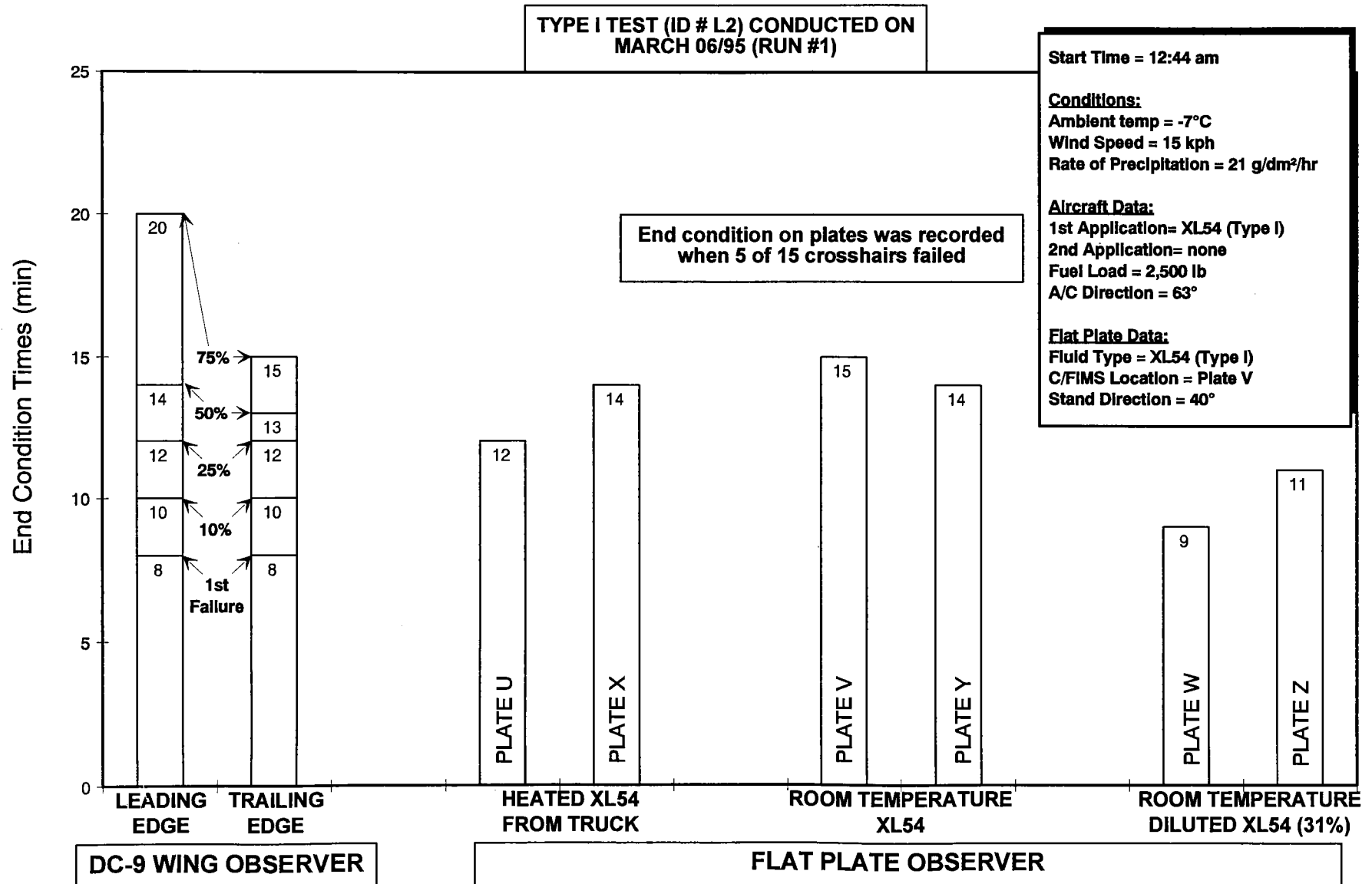

FIGURE 2.5

**SAMPLE COMPARISON OF END CONDITION TIMES FROM THE AIRCRAFT
WING OBSERVER AND FLAT PLATE OBSERVER
(Test ID # T1 YYT DC-9 Starboard)**

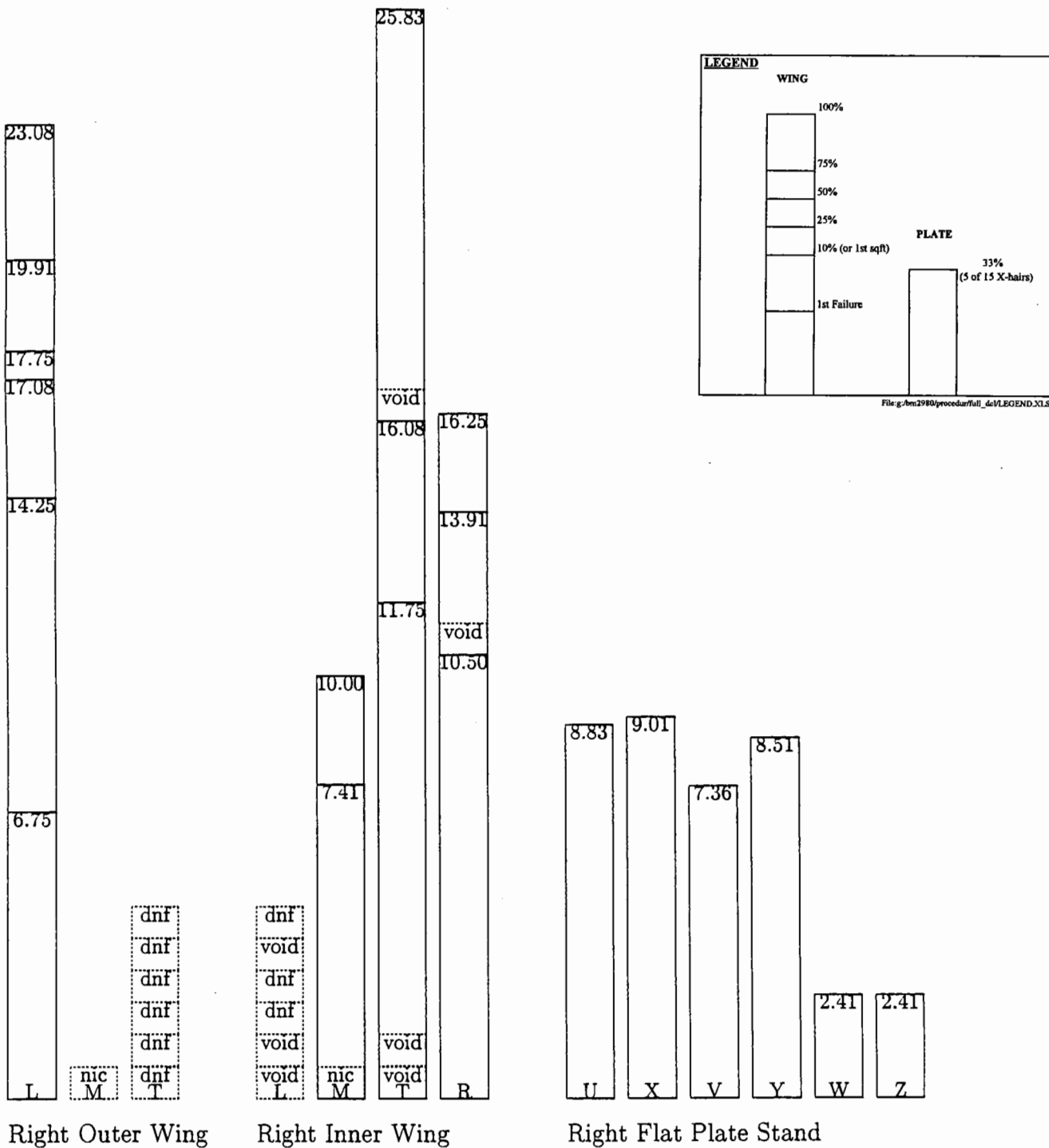

Figure 33: Test 1A Right - DC-9 Fluid Failure Observation Times: Amb. tmp. -6.22°C, W. Spd. 31.48km/hr, W. Dir. 50° E of N, Precip. Rate 9.71 g/dm²/hr, Aircraft Orient. 350° E of N, F/P Orient. 50° E of N.

2. SIMULTANEOUS AIRCRAFT AND FLAT PLATE TESTS

Time stamps indicated on the bar charts are in minutes and represent the delay between the time of commencement of anti-icing fluid application and the time when the observer identified the various levels of fluid failure. Conditions defining "FLUID FAILURE" are presented in Appendix A "Experimental Program for Dorval Natural Precipitation Flat Plate Testing" Section 5 (End Conditions).

The L, M and T bars each have six fluid failure entries which correspond to standard definitions of levels of failures within each of the regions (leading edge, middle section, trailing edge):

1. First Failure: occurred when the test fluid within the wing region was first observed to have failed;
2. 10% failure: when approximately 10% of the wing region had failed test fluid;
3. 25% failure: when approximately 25% of the wing region had failed test fluid;
4. 50% fluid failure: when approximately 50% of the wing region had failed test fluid;
5. 75% fluid failure: when approximately 75% of the wing region had failed test fluid; and
6. 100% fluid failure: when 100% of the wing region had failed test fluid.

In Figure 2.5, four fluid failure entries for the representative surface observations are reflected, corresponding to:

1. First Failure: when the test fluid on the aircraft wing's representative surface was first observed to have failed;
2. 10% fluid failure: when approximately 10% of the representative

2. SIMULTANEOUS AIRCRAFT AND FLAT PLATE TESTS

- surface had failed de-icing fluid;
3. 50% fluid failure: when approximately 50% of the representative surface had failed de-icing fluid; and
 4. 100% fluid failure: when 100% of the representative surface had failed de-icing fluid.

Flat plate stand observations were limited to one failure call per flat plate. Flat plate failure criteria consisted of failure of five of the fifteen crosshairs on the flat plate. Failure times are represented by individual time stamps (minutes) representing the delay from start of fluid application to the time of failure.

2.5 Aircraft Wing Fluid Failure Analysis

2.5.1 Wing Grid Structure

During the full-scale tests, observers assigned to the wing section were required to identify where the first observed failure of FPD (freezing point depressant) fluid occurred; where the 10% area of failed FPD fluid occurred, as well as the progression of failure on the wing. To facilitate this, each wing section was divided into three subsections:

1. Leading Edge (L or LE);
2. Middle (M or ME); and
3. Trailing Edge (T or TE).

These are illustrated in Figure 2.6 which shows the wing data form for a DC-9 aircraft. Referring to it, the trailing edge is defined as the area between the inner edge of the aileron and flap hinges and the trailing edge of the wing. This is easily identified visually on the actual wing surface. The boundary of the wing leading edge is also easily identified by a highly visible seam in the aluminum skin, located where the curvature of the upper wing surface begins to taper off and round out towards the under wing surface. The remaining wing section was referred to as the middle. The wing diagram is marked 1 through 7 to produce a grid structure. This grid structure allowed personnel to identify the sections for which they were responsible and to make the assigned observation calls. This aircraft wing grid structure was provided for standardization of test procedures at all locations.

FIGURE 2.6

DE/ANTI-ICING FORM FOR AIRCRAFT WING

REMEMBER TO SYNCHRONIZE TIME

VERSION 2.3

Winter 94/95

LOCATION:	DATE:	RUN NUMBER:	WING # :	RVSI AVAILABLE: Y / N
Time After Fluid Applied to Plates U and X:	am / pm			C/FIMS SENSOR AVAILABLE: Y / N

TIME OF INITIAL FLUID APPLICATION: _____ (min)
(Last step only)

TIME AFTER FLUID APPLICATION: _____ (min)
(Last step only)

DIRECTION OF AIRCRAFT: _____

FAILURES CALLED BY: _____

DESCRIBE SENSORS/LOCATION: _____

HANDWRITTEN BY: _____

ASSISTED BY: _____

COMMENTS: _____

IMPORTANT EVENTS (min)				
	<u>L.Edge</u>	<u>Mid</u>	<u>T.Edge</u>	<u>Rep. Surface</u>
1st Failure:	_____	_____	_____	_____
10% :	_____	_____	_____	_____
25% :	_____	_____	_____	_____
50% :	_____	_____	_____	_____
75% :	_____	_____	_____	_____
100% :	_____	_____	_____	_____

DRAW FAILURE CONTOURS ACCORDING TO THE PROCEDURE

(Indicate Representative Surface on Drawing)

DC-9 Series 30

File: Afrm2_3b.drw

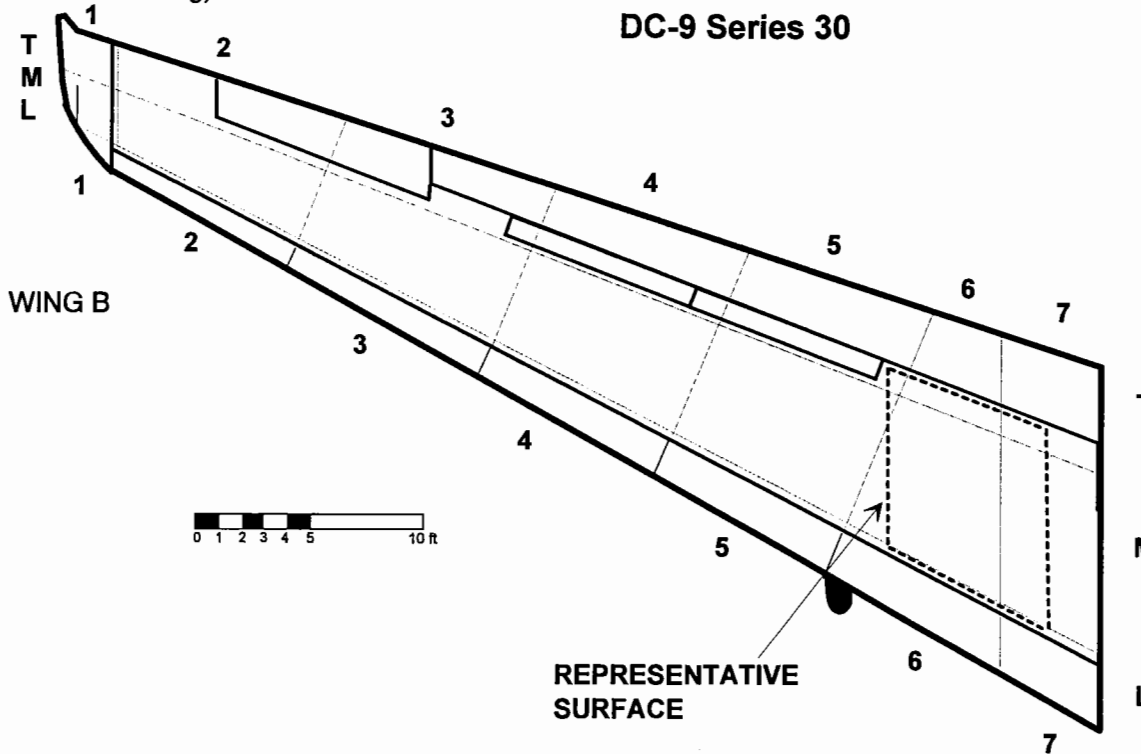

22

2.5.2 Wing Failure Analysis

This section of the report addresses the relationship between first failure and 10% failure observation times and the location of these failures on the wing surface. Table 2.2 contains the relevant information which was compiled from the bar charts contained in Figure 2.4, Figure 2.5 and all the Appendix C bar charts. The location of failure is based on the generic wing surface grid shown in Figure 2.6. Table 2.2 allows an assessment of the location on the wing where initial fluid failure occurred in tests, in conjunction with information on wind direction. The representative surface first fluid failure and 10% fluid failure observations are also included.

During some full-scale tests there were a number of instances where the occurrence of first and 10% fluid failure could not be obtained. The entry "void" indicates that the observation was not obtained; "dnf" indicates that the surface did not fail.

Observers for tests in St John's were located only at the leading edge. These observers sometimes had difficulty in identifying the first fluid failure on the trailing edge due to the distance, visibility reduction during blowing precipitation, and size of failure area involved. In these tests, first failures may have occurred on the trailing edge more often than recorded. Failures using the criteria of 10% of leading edge/trailing edge/mid wing areas, were easier to identify and less susceptible to observation error.

TABLE 2.2

Time and Location of Wing and Representative Surface First failure and 10% Failure

ID # Loc	TEST	A		B		C		D		WIND DIRECTION	A - B		C - D	
		1st Failure Time (min)	Location	1st Failure/rep. (min)	10% Failure Time (min)	Location	10% Failure/rep (min)	1st LE/TE/M-rep (min)	10%LE/TE/M-rep (min)					
L1	L1	9	TE	19	12	TE	20	CROSS/H	-10	-8				
L2	L2	8	T/L	9	10	TE/LE	11	HEAD	-1	-1				
L3	L3	9	LE	9	12	LE	12	HEAD	0	0				
L4	L4	14	LE	12	23	LE	n/a	HEAD	2					
L5	L5	8	T/L	8	12	LE	20	HEAD	0	-8				
L6	L6	30	TE	40	50	TE	60	HEAD	-10	-10				
L7	L7	20	LE	22	24	LE	24	HEAD	-2	0				
L8	L8	8	LE	15	11	LE	20	CROSS/H	-7	-9				
L9	L9	10	T/L	12	12	TE	14	CROSS/H	-2	-2				
T1	1A Left	10	TE	20	10	TE	20	CROSS/H	-10	-10				
T1	1A Right	7	LE	11	12	TE	void	CROSS/H	-4					
T2	1B Left	9	LE	dnf	12	TE	dnf	CROSS/H						
T2	1B Right	11	LE	16	17	LE	29	CROSS/H	-5	-12				
T3	2A Left	7	LE	12	7	LE	15	HEAD	-5	-7				
T3	2A Right	7	LE	void	9	LE	void	HEAD						
T4	2B Left	7	LE	11	8	LE	void	HEAD	-4					
T4	2B Right	6	LE	8	8	LE	12	HEAD	-2	-4				
T5	2C Left	8	TE	10	8	TE	11	HEAD	-2	-2				
T5	2C Right	6	LE	6	11	LE	8	HEAD	0	2				
T6	3A Left	7	TE	7	7	TE	11	HEAD	0	-3				
T6	3A Right	9	TE	10	11	TE	15	HEAD	-1	-5				
T7	3B Left	3	TE	3	4	TE	3	HEAD	0	1				
T7	3B Right	3	TE	3	4	TE	4	HEAD	0	0				
T8	3C Left	3	TE	3	3	TE	void	HEAD	0					
T8	3C Right	3	TE	2	4	TE	4	HEAD	0	0				
T9	3D Left	4	TE	6	5	TE	8	HEAD	-2	-3				
T9	3D Right	4	TE	4	5	TE	7	HEAD	0	-2				
T10	4A Left	void	M	n/a	void	LE	n/a	CROSS/H						
T10	4A Right	void	TE	n/a	void	TE	n/a	CROSS/H						
T11	4B Left	10	TE	n/a	12	TE	n/a	HEAD						
T11	4B Right	void	TE	n/a	void	TE	n/a	HEAD						
T12	5A Left	6	TE	void	6	TE	22	TAIL		-16				
T12	5A Right	void	void	9	9	TE	13	TAIL		-3				
T13	5B Left	void	void	void	void	void	void	TAIL						
T13	5B Right	void	void	void	void	void	void	TAIL						
T14	5C Left	9	TE	29	9	TE	33	TAIL	-20	-24				
T14	5C Right	10	LE	30	20	TE	31	TAIL	-20	-11				
Z1	Z1	8	LE	22	10	LE	dnf	HEAD	-14					
Z2	Z2	23	M	17	24	M	19	CROSS/T	6	5				

void = observation not obtained.

dnf = did not fail.

n/a = not applicable.

2. SIMULTANEOUS AIRCRAFT AND FLAT PLATE TESTS

Table 2.3 contains a count of the first occurrence of fluid failure and 10% occurrence of fluid failure in terms of location. The table originates from Table 2.2 and a count of one is assigned per match. Because the middle wing region was not monitored by Instrumar in tests T1 to T9, the table is based on tests L1 to L9, T10 to T14, and Z1 and Z2.

The wind direction relative to the aircraft is also included in the table. The wind direction has been classified in three main categories: head wind, cross wind and tail wind. When the difference between the wind direction and aircraft longitudinal axis direction is 45° or more, the wind is considered to be a cross wind. In Tables 2.2 and 2.3, CROSS/H and CROSS/T, indicate that the wind is blowing from the side of the aircraft but from partially ahead (into the leading edge) or partially from the tail (into the trailing edge) respectively.

Comparison of wing temperature measurements (Appendix D) to ambient temperature yielded differences of less than one degree C., showing that NONE of the tests involved cold-soaked wings.

The following observations can be made from the data in Table 2.3:

- 1) With a head wind, first failures occurred exclusively at the leading edge and trailing edge. Early trailing edge failure can be attributed to the fact that the fluid flow from the middle of the wing to the trailing edge is mostly dissipated in discontinuities, flap and spoiler hinges and recesses, with very little reaching the actual trailing edge.

TABLE 2.3

Tally of First and 10% Failure Locations Relative to Wind Direction

		TEST WHERE MIDWING WAS MONITORED			ALL TESTS			
		WIND	LE	M	TE	LE	M	TE
1st FAILURE	HEAD	5	0	4	10	0	13	
	CROSS/H	1.5	1	2.5	4.5	1	3.5	
	CROSS/T	0	1	0	0	1	0	
	TAIL	1	0	2	1	0	2	
	TOTAL	7.5	2	8.5	15.5	2	18.5	
10% FAILURE	HEAD	5.5	0	3.5	10.5	0	12.5	
	CROSS/H	2	0	3	3	0	6	
	CROSS/T	0	1	0	0	1	0	
	TAIL	0	0	4	0	0	4	
	TOTAL	7.5	1	10.5	13.5	1	22.5	

For the wind condition prevailing, each count represents a test occasion when a particular wing location was the site of first failure or initial 10% failure.

2. SIMULTANEOUS AIRCRAFT AND FLAT PLATE TESTS

At the leading edge there are no discontinuities to stop the fluid flow from reaching the nose of the leading edge, however the fluid thickness in this region, as well as at the trailing edge, can be expected to be appreciably thinner than on the top surface of the wing. Results of thickness tests reported in "Aircraft Ground De/Anti-icing Fluid Holdover Time Field Testing Program for the 1993-1994 Winter", Test Results Summary¹, supported this observation. The effect of the thinner fluid may be counter-acted to some degree by the head wind itself which may partially and intermittently restrain the fluid from running off the sloped surface. Early failure in head wind conditions in the leading edge region will be further aggravated by snow or other precipitation being blown by the wind and impacting directly on the nose of the leading edge.

If tests T1 to T9 (excluded as the middle wing region was not monitored) are included in the analysis, the same observations are supported.

- 2) Continuing with the head wind case, the number of first failure occurrences and 10% failures are about the same at the leading edge and the trailing edge. This implies that the wind effects that influenced the first failure occurrence probably also influenced the 10% failure occurrence. The 10% failure occurred at the same location as the first failure, indicating that failure can be expected to progress from where it started originally. Examination of

¹

"Aircraft Ground De/Anti-icing Fluid Holdover Time Field Testing Program for the 1993-1994 Winter", Test Results Summary, APS Aviation Inc., September 1994, 84 p.

2. SIMULTANEOUS AIRCRAFT AND FLAT PLATE TESTS

"ALL TESTS" supports these observations, with 10.5 leading edge 10% failures vs 12.5 trailing edge 10% failures. (The 0.5 value results from simultaneous calls on the leading and trailing edges).

- 3) The middle region of the wing has been observed to be insensitive to fluid failures in the case of head winds and this can be confirmed from examination of the data. It should be noted however, that this conclusion is based only on results of tests L1 to L9, T10 to T14, and Z1.
- 4) The data sets for the cross and tail wind cases are too limited to make strong conclusions. However, when data from all tests is examined, the result is 4.5 leading edge first failures vs 3.5 trailing edge first failures and 1 mid-wing first failure for the CROSS/H category. Also 3 leading edge 10% failures vs 6 trailing edge 10% failures were obtained for that same category. This means that the leading edge and trailing edge were still the most prone to failure initiation, however the trailing edge shows itself to be the most sensitive when it comes to failure progression.

Tail wind data for first failure does not support strong conclusions since the sample number is small. However, with 1 leading edge failure and 2 trailing edge failures, there seems to be a balance between the two regions. At the 10% failure level, the trailing edge region appears to be more sensitive to failure progression.

2. SIMULTANEOUS AIRCRAFT AND FLAT PLATE TESTS

All full-scale tests were conducted using parked aircraft. In operation, the pilot will be checking movement of aircraft flaps and ailerons. This movement may affect the fluid flow patterns and make the flaps fail earlier than observed during the full-scale tests. Such an operational check depends largely on the airline and airport in its time duration and angular amplitude. However, it makes the trailing edge section that much more critical and failure susceptible.

- 5) The total number of first failure and 10% failure occurrences for leading edge, trailing edge and middle region for all wind cases is reported in the "TOTAL" line of Table 2.3. The predominance of the leading edge and trailing edge regions for the first failure occurrence is notable, with the trailing edge being slightly more sensitive than the leading edge. At 10% failure, the same observation holds with the trailing edge being appreciably more sensitive than the leading edge.
- 6) In conclusion, the trailing edge and leading edge regions are the most failure sensitive regions in the case of head wind. The trailing edge region appears to be more sensitive than the leading edge region. Based on the limited sample, the middle region seems to become failure sensitive only in the case of cross wind and possibly tail wind.

A map of typical failure progression on a wing surface, developed from an actual test, is shown in Figure 2.7. Many of the foregoing comments are clarified through illustration.

FIGURE 2.7
FAILURE TIME PROGRESSION FOR A TYPE I TEST
MARCH 06/95, RUN #1 (ID # L2)

Test conditions were:

- Leading edge was into the wind
- Wind speed was 15 kph
- DC-9 Series 30 was used
- Type of Precipitation was snow

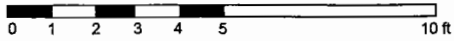
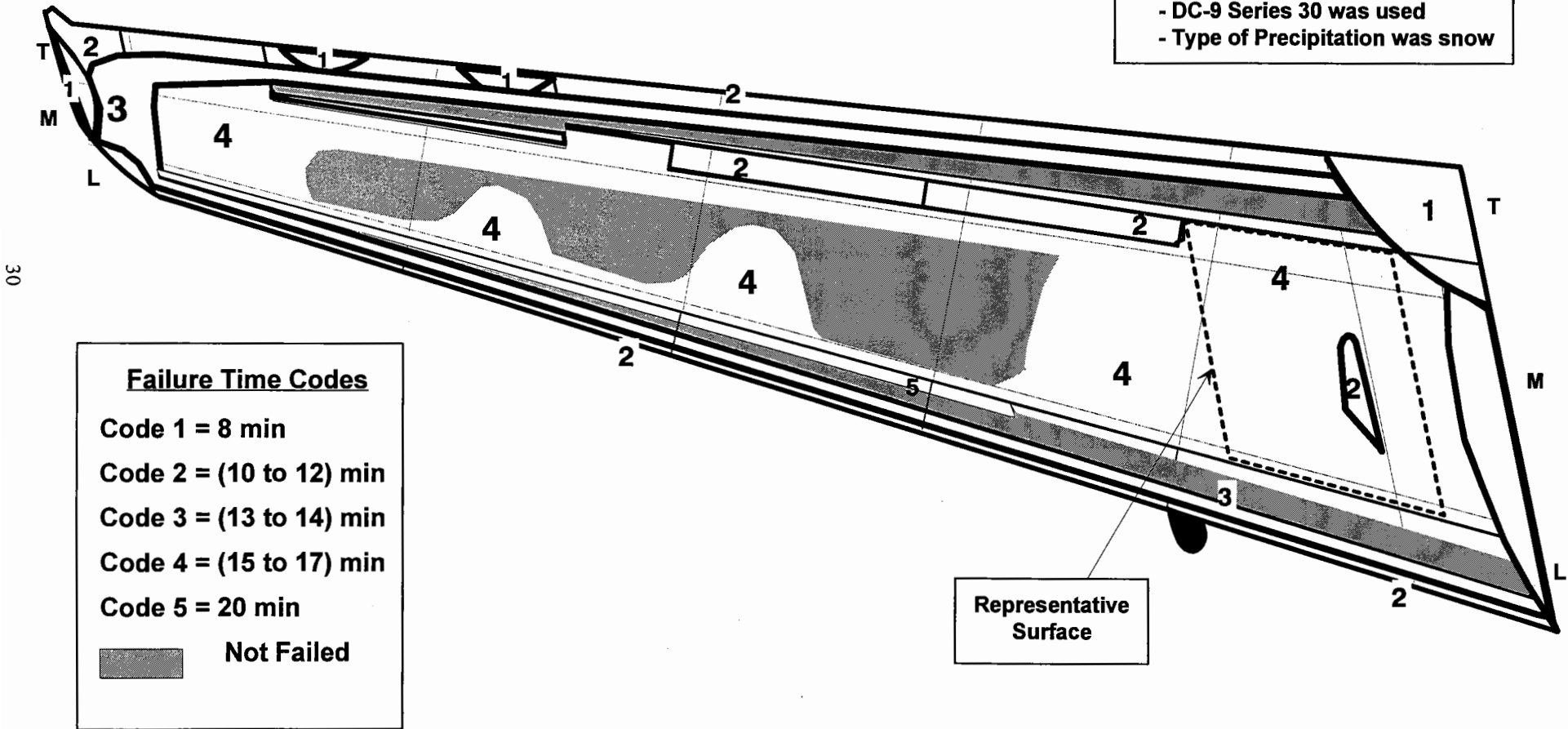

2.5.3 Inside Observer vs Outside Observer Failure Calls

The results discussed to this point derive from data obtained by outside observers. In the Dorval and Toronto full-scale tests, an inside observer, usually a commercial pilot, was positioned in the aircraft cabin with the aim of identifying and comparing apparent fluid failures from that location. Table 2.4 compares the data provided by inside and outside observers.

The observations and failure calls from the cabin in most instances came later than outside observer failure calls. When the failure occurred on the far half of the wing, the inside observer had additional difficulty in identifying the failure. Contributing factors were glare and bad lighting, as well as the fact that the far half of the wing was simply too far away for failures to be discernible from the cabin. Additionally, as discussed in the next section, it was observed that the representative surface, intended to assist in fluid failure identification from inside the cabin, tended to fail later than other areas of the wing.

2.5.4 First and 10% Fluid Failure Occurrence on Representative Surface Compared to Leading Edge, Trailing Edge or Mid-Wing.

Table 2.5 was derived directly from the two last columns of Table 2.2 by counting the number of events when the representative surface failed before, after or at the same time as the leading edge, trailing edge or mid-wing. First failure as well as failure at the 10% wing area criteria are examined. The purpose of this data gathering and analysis was to determine the effectiveness of the representative surface concept.

TABLE 2.4

Comparison of Inside Observer and Outside Observer Failure Times (minutes)

TEST	1st FAILURE TIME		10% FAILURE TIME		25% FAILURE TIME	
	O.O.*	I.O.*	O.O.	I.O.	O.O.	I.O.
L1	9	10	12	12	14	15
L2	8	N.S.**	10	12	12	21
L3	9	N.S.**	12	17	15	20
L4	14	19	23	N.S.**	25	22
L5	8	17	12	18	16	21
L6	30	25	50	35	58	45
L7	20	24	24	32	48	45
L8	8	5	11	14	13	16
L9	10	8	12	12	13	N.S.**
Z1	8	N.S.**	10	11	17	N.S.**
Z2	12	N.S.**	24	50	70	N.S.**
I.O.<O.O.	3		1		3	
I.O.>O.O.	8		9		8	
I.O.=O.O.	0		1		0	

* I.O. = Inside observer, O.O. = Outside Observer

** N.S. = Not Seen

TABLE 2.5

**Count of Earlier and Simultaneous Occurrence of Failure
on the Representative Surface or LE, TE, or M.**

	WIND	Rep. Surface Failing First	LE, TE or M Failing First	Simultaneous Failure
1st FAILURE	HEAD	1	5	2
	RIGHT/F	0	2	0
	RIGHT/B	1	0	0
	REAR	0	2	0
	TOTAL	2	9	2
10% FAILURE	HEAD	1	6	2
	RIGHT/F	0	2	0
	RIGHT/B	1	0	0
	REAR	0	2	0
	TOTAL	2	10	2

2. SIMULTANEOUS AIRCRAFT AND FLAT PLATE TESTS

- 1) First failure of leading edge, trailing edge or mid-wing occurred before the representative surface 9 times out of 13, and simultaneously with the representative surface 2 times out of 13.
- 2) 10% failure of leading edge, trailing edge or mid-wing occurred before the representative surface 10 times out of 14.

The wing area currently selected to serve as representative surface does not appear to be a fully effective reference for fluid failure as earlier failure occurred elsewhere on the wing about 70% of the time. These results were despite the influence of a raised patch within the DC-9 representative surface which caused fluid thinning and triggered fluid failure.

As discussed in Section 2.5.2, Wing Failure Analysis, occurrence of first failure as well as fluid thickness tests, show that the leading edge is a critical area. Because failure here has a very detrimental influence on lift, location of the representative surface on the wing leading edge should be considered.

2.6 Wing Failure vs Flat Plates Failure for Type I XL54 De-icing Fluid

2.6.1 Type I XL54 at Room Temperature Condition

This section of the report examines the relationship between time for Type I (XL54) fluid to fail on an aircraft wing versus time to fail on flat plates. Standard fluid plates (V and Y) were selected for comparison as they were subjected to XL54 fluid conditioned at room temperature prior to application, duplicating the condition under which XL54 fluid was tested in previous flat plate holdover time substantiation trials.

Figures 2.8, 2.9 and 2.10 show aircraft failure times (time to first failure and failure times for 10% and 25% of the wing leading edge/trailing edge/mid-wing area) plotted vs standard fluid plates (V and Y) average failure times. A one-to-one line is also shown on all three charts. The points are differentiated with respect to the test location (YUL, YYT, YYZ).

Figure 2.8 shows that the flat plates failure times were greater than the first failure times on the actual aircraft. Wing first failure occurs before standard fluid plate failure 86% of the time. Plate failure time was about 77% longer on average than wing first failure time (deviation was 96%).

Figure 2.9 shows flat plate failure times were also greater than failure times for 10% of wing leading edge/trailing edge/mid-wing area. However, the points are relatively closer to the one-to-one line with a greater number of them above the line suggesting a better correlation.

FIGURE 2.8
AIRCRAFT 1st FAILURE vs. PLATES V&Y FAILURE

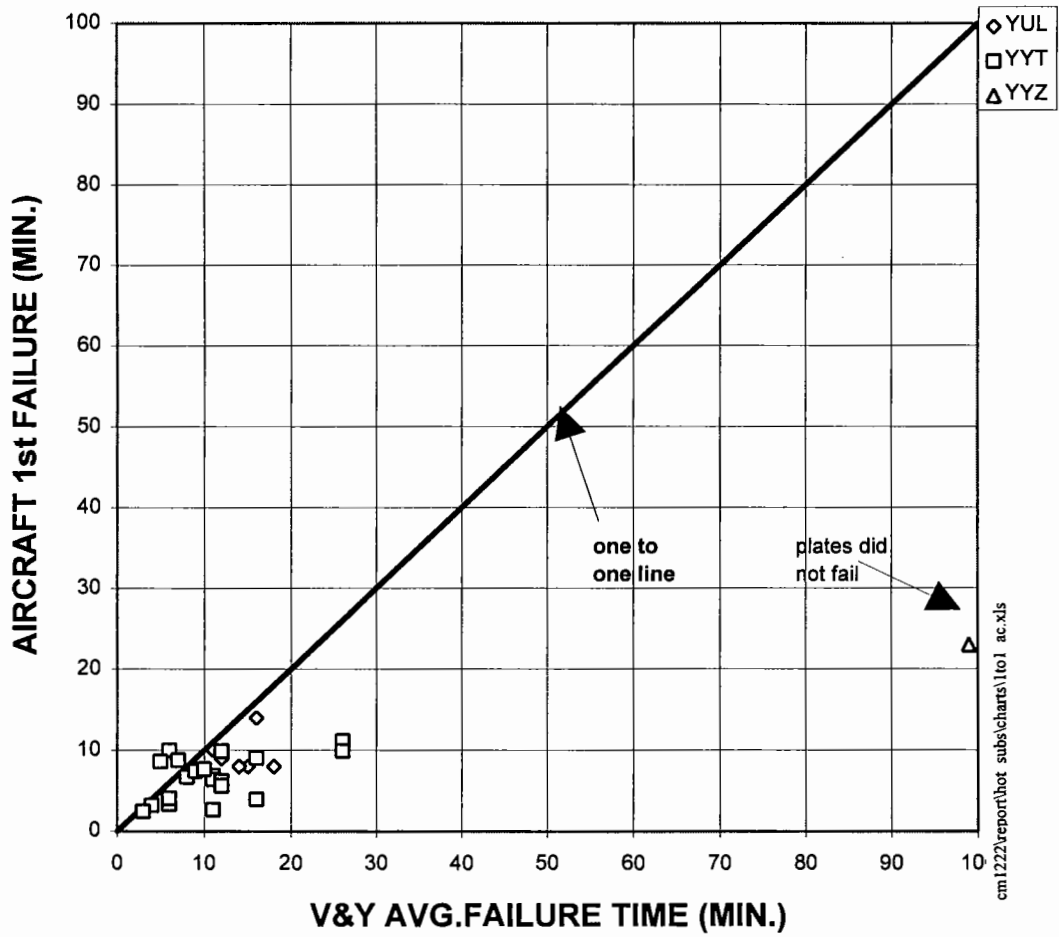
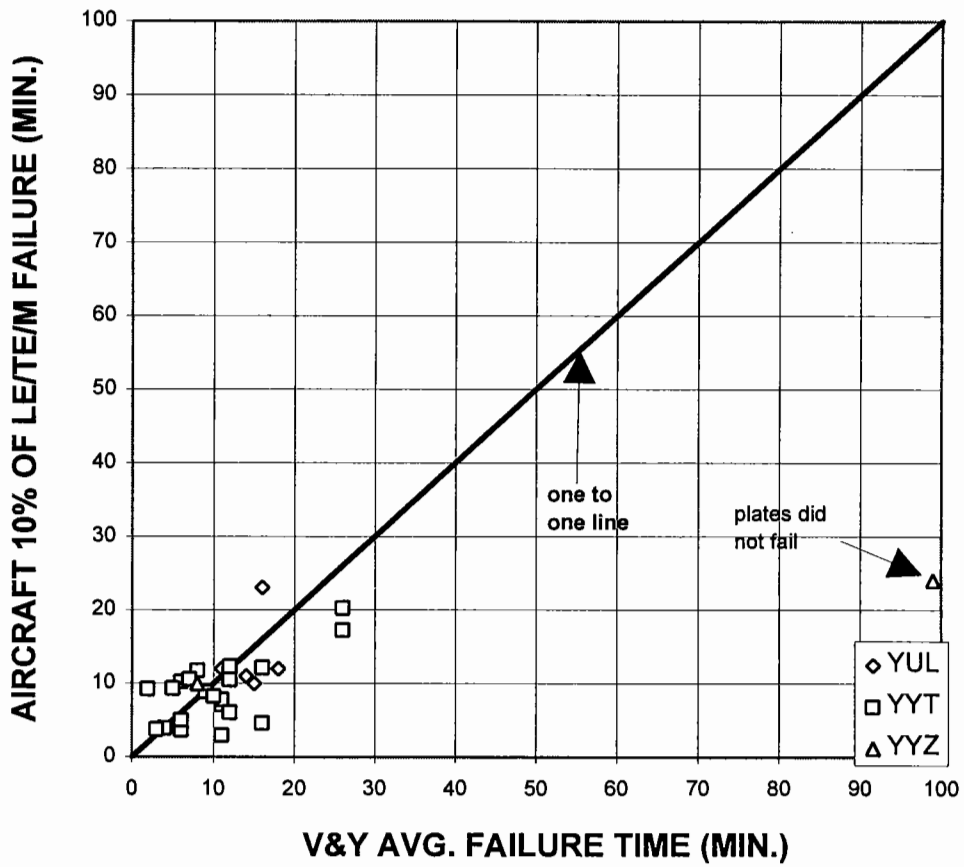
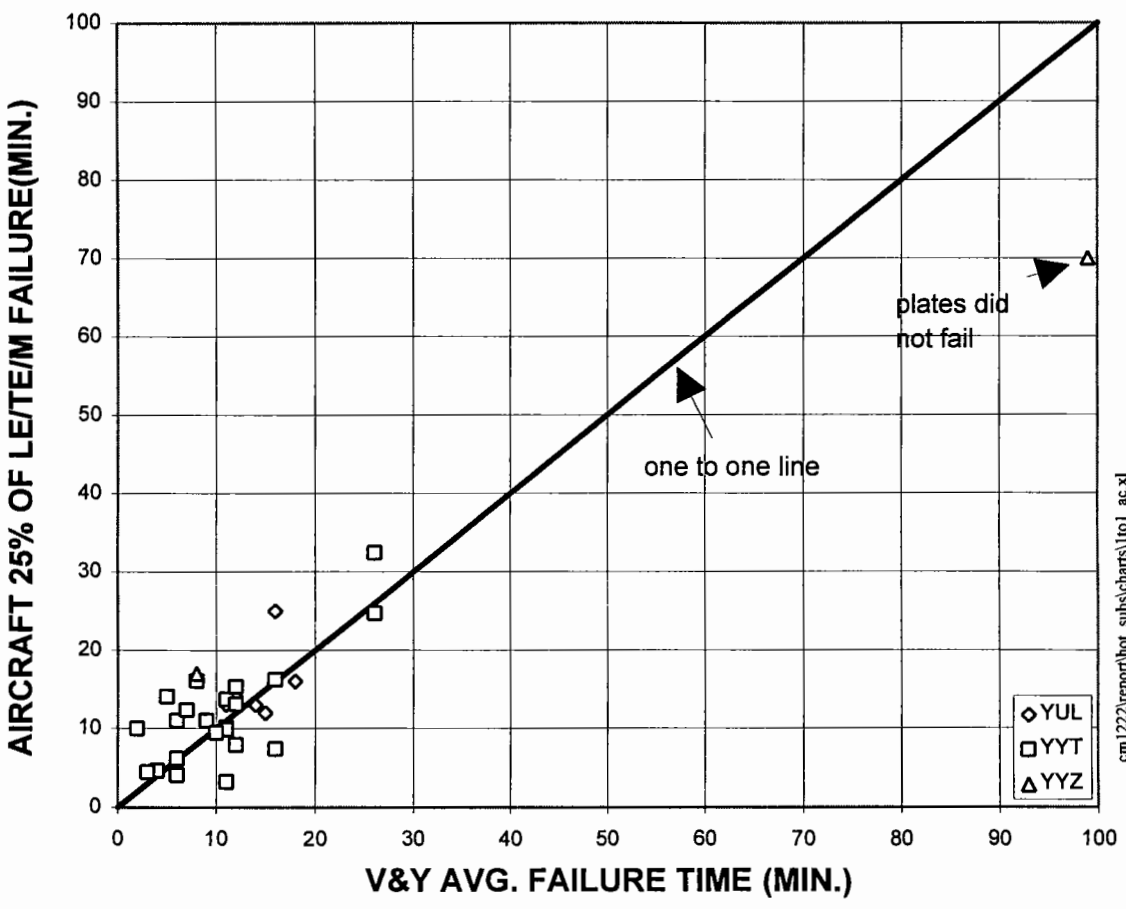

FIGURE 2.9
AIRCRAFT 10% OF LE/TE/M FAILURE
vs. PLATES V&Y FAILURE



cm1222\report\hot subs\charts\1to1 ac.xls

FIGURE 2.10
AIRCRAFT 25% OF LE/TE/M FAILURE
vs. PLATES V&Y FAILURE



cm1222\report\hot subs\charts\1to1 ac.xl

2. *SIMULTANEOUS AIRCRAFT AND FLAT PLATE TESTS*

The wing failed before the plates 63% of the time. Plate failure time was about 37% longer on average than wing failure time (deviation was 91%).

Figure 2.10 shows good correlation between flat plate average failure times and failure times for 25% of wing leading edge/trailing edge/mid-wing, with data points somewhat evenly dispersed around the one-to-one line. Taking the amount of scatter into account, failure times for 25% of wing leading edge/trailing edge/mid-wing can be considered to be the equivalent of failure times for flat plates. The wing failed before the plates 40% of the time. Plate failure time was about 1% longer on average than wing failure time (deviation was 60%).

Considering that neither the trailing edge nor the leading edge account for more than 25% of the total wing area, it can be seen that 25% of leading edge/trailing edge is really equivalent to less than 10% of the entire wing area. While the middle section is larger, relatively few failures occurred there. When the total wing is considered, there is not much difference between failure at 25% of leading edge/trailing edge and failure at 10% of total wing area, and it can be concluded that Type I fluid flat plate holdover times (based on 33% failure criteria) are equivalent to failure times of 10% or less of the entire wing area.

The question as to whether up to 10% of the wing surface area represents an acceptable level of contamination needs to be addressed. An NRC project planned for 1995/96 examining aerodynamic penalties caused by frozen precipitation on aircraft wings will address this question.

2. *SIMULTANEOUS AIRCRAFT AND FLAT PLATE TESTS*

Results of these tests are supported by results experienced by United Airlines in trials conducted at Denver Stapleton Airport in Winter 1992/93. A total of forty-six individual tests were conducted to determine holdover times of Type I and Type II fluids on aircraft (B-727/B-737) surfaces. Aircraft fluid holdover times versus precipitation rates were compared to flat plate holdover times and precipitation rates from previous tests. The conclusion drawn was that on-aircraft holdover times validated the SAE/ISO guidelines for the conditions measured, and that end of protection or holdover times on flat panels are similar to those observed on an aircraft wing.

Comparison of the results obtained on standard fluid flat plates in these tests to results obtained from the "Aircraft Ground De-icing Fluid Holdover Time Field Testing Program for the 1994-1995 Winter"², reflect the commonality of procedures and results for snow, freezing drizzle and light freezing rain.

The comparison shows that:

- for snow test conditions, the flat plate data recorded in the present tests falls well within data range of Winter 1994/95 fluid holdover time tests; and
- for freezing drizzle and light freezing rain test conditions, the data falls within or exceeds the data range of the Winter 1994/95 simulated holdover time tests.

²

"Aircraft Ground De/anti-icing Fluid Holdover Time Field Testing Program for the 1994-1995 Winter", TP 12654E, December 29 1995, APS Aviation Inc., 180 p.

2. SIMULTANEOUS AIRCRAFT AND FLAT PLATE TESTS

When comparing the current and proposed HOT's with the first failure times on the aircraft, the following is observed:

- for snow test conditions, first failure times on the wing were within or above the current SAE/ISO HOT range of 6 to 15 minutes for Type I fluids applied at air temperature; and
- for other freezing precipitation test conditions, first failure times were within or above the proposed SAE HOT range of 2 to 5 minutes for the proposed light freezing rain column.

2.6.2 Effects of Heated Type I Fluid

Type I was applied in accordance with SAE/ARP 4737. The nature of these tests also enabled an examination of the impact on holdover time from application of heated fluid. Figure 2.11 compares failure times on flat plates for XL54 fluid, in one case heated by the de-icing truck to normal operating temperature (165°F), and in the other applied at room temperature. This data was compiled from snow tests only. The cluster of data points below the one-to-one line, lead to the conclusion that heated fluids lasted a little longer than the non-heated fluids.

FIGURE 2.11
COMPARISON OF PLATE FAILURE TIME OF ROOM TEMPERATURE
XL54 vs HEATED XL54 FROM TRUCK
 1994 - 1995

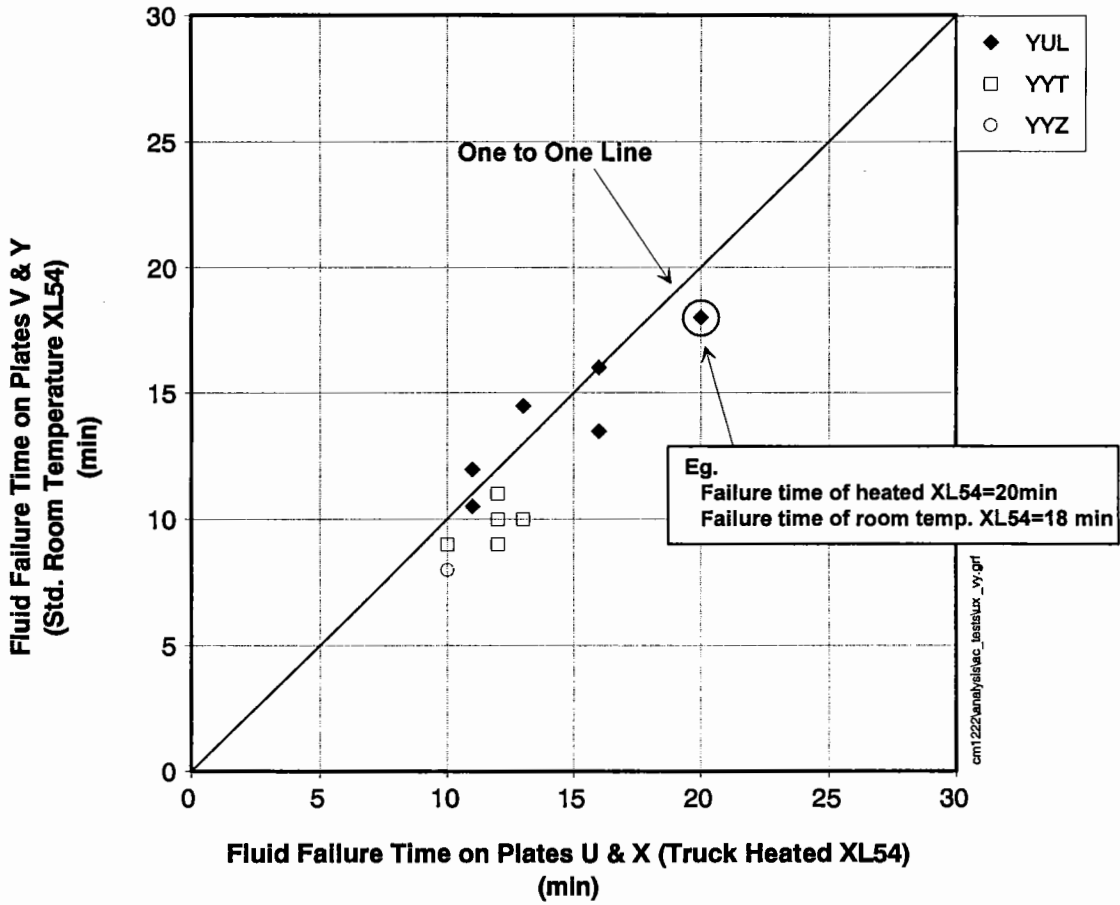

2.7 Analysis of Ultra Fluid Behaviour on a Wing

This section of the report examines the relationship between time for Ultra fluid to fail on an aircraft wing versus time to fail on flat plates.

Ultra fluid tests (L3, L6 and L7) were conducted at Dorval. In these tests, Ultra fluid was applied in two different ways. Tests L3 and L7 consisted of a heated XL54 Type I fluid application (at 165°C) followed by the unheated Ultra application, whereas L6 consisted of one application of a Hot Ultra coating at 77°C. Refer to Figure 2.3 for procedures followed in fluid application on the different surfaces.

Table 2.1 provides all relevant fluid failure data for the Ultra tests. Data from tests L3, L6 and L7 indicates that failure times for all three failure criteria, first failure, 10% and 25% failure of leading edge/trailing edge/mid-wing area, are significantly shorter than failure times for concurrent standard fluid test plates (V and Y). In fact, concurrent standard fluid test plates failure times seem to have a stronger correlation with failure criteria of 100% of leading edge/trailing edge/mid-wing area, which would mean in effect that the entire wing surface could be in a failed condition within holdover times established based on plate failure times.

To illustrate this, the data points resultant from tests L3, L6 and L7 have been superimposed (Figure 2.12) on results of flat plate testing of Type II fluid determined within the "Aircraft Ground De-icing Fluid Holdover Time Field Testing Program for the 1994-1995 Winter"². For each of the three tests L3, L6 and L7, failure times for concurrent standard fluid test plates are well within the data ranges determined in the previous holdover time flat plate tests, showing consistency in procedures and results.

2

"Aircraft Ground De/anti-icing Fluid Holdover Time Field Testing Program for the 1994-1995 Winter", TP 12654E, December 29 1995, APS Aviation Inc., 180 p.

FIGURE 2.12
**EFFECT OF FLUID TYPE AND RATE OF PRECIPITATION ON
 TYPE II NEAT FLUID FAILURE TIME IN NATURAL SNOW CONDITIONS**

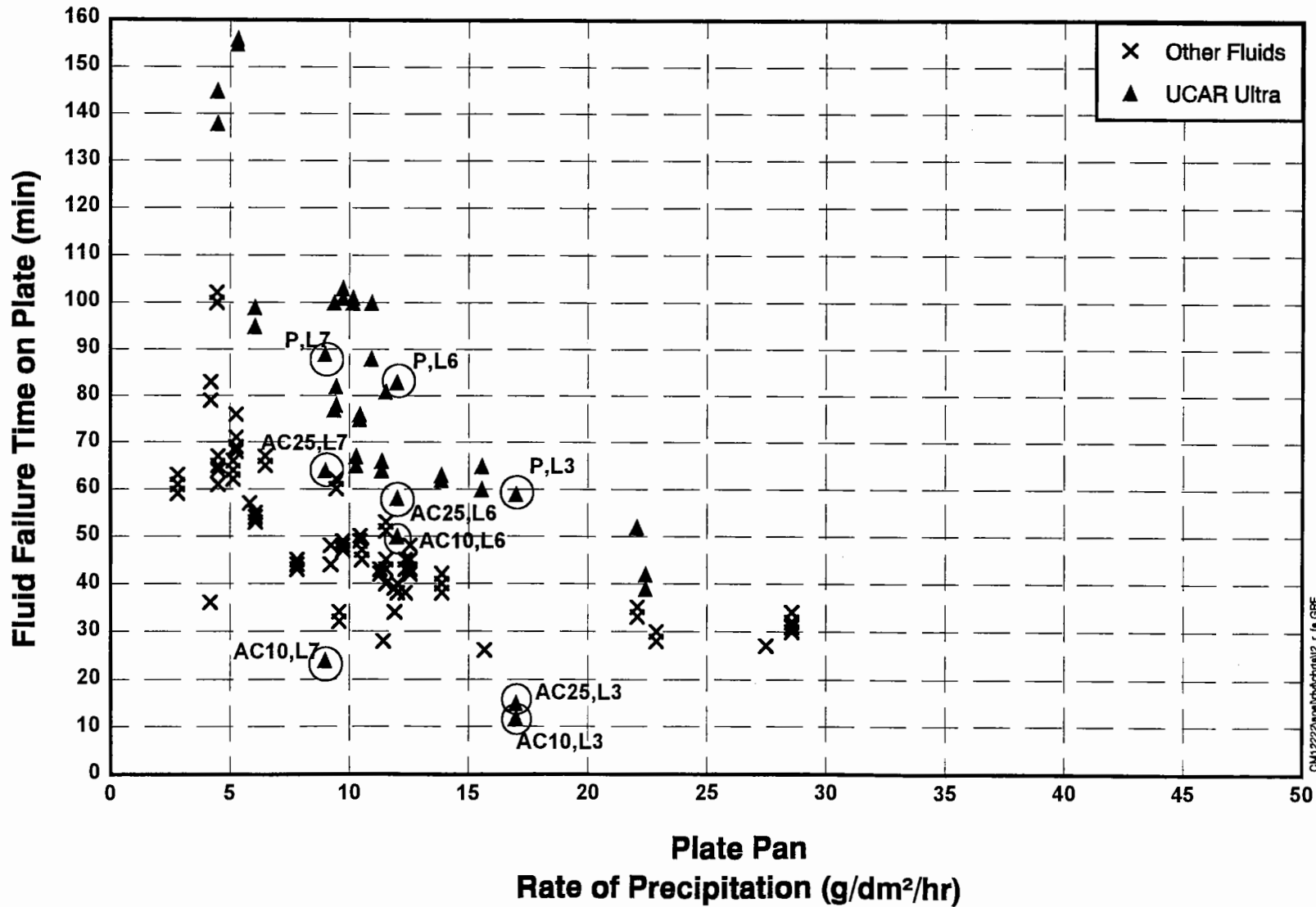

2. SIMULTANEOUS AIRCRAFT AND FLAT PLATE TESTS

However, aircraft wing results at the 10% leading edge/trailing edge for tests L3 and L7 are clearly well below the flat plate results for Ultra, as well as for other neat Type II fluids.

Aircraft wing results at the 25% leading edge/trailing edge generally fall below Ultra flat plate results and correspond more closely to the conventional Type II fluid flat plate tests.

Test L6 (Figure 2.13) in which Ultra was applied in heated condition to the wing and to the truck fluid plates, shows a performance improvement over tests L3 and L7 for both the wing and the flat plates. However, the wing results are still below the performance of cold Ultra on flat plates. Heating the Ultra fluid in the de-icing vehicle appeared to change the fluid's consistency in that it appeared to be more foamy than when cold, and took on the consistency of a "shaving cream". Whether performance improvement was influenced by this change in consistency as opposed to heat transfer to the wing is not known.

A number of factors associated with methods of application may have contributed to early failures on the wing:

- 1) The de-icing vehicle operated from the rear of the wing with fluid applied from the trailing edge, perhaps giving poor coverage to the leading edge where many of the early failures occurred.
- 2) The de-icing vehicle was equipped with a spray nozzle normally used for Type I fluid, with a high pump pressure. Union Carbide, who developed and produce Ultra fluid, recommends the use of a fan nozzle with a low pressure setting to achieve optimum coverage over the entire wing surface.

**FIGURE 2.13
COMPARISON OF END CONDITION TIMES
FROM THE DC-9 WING OBSERVER AND FLAT PLATE OBSERVER**

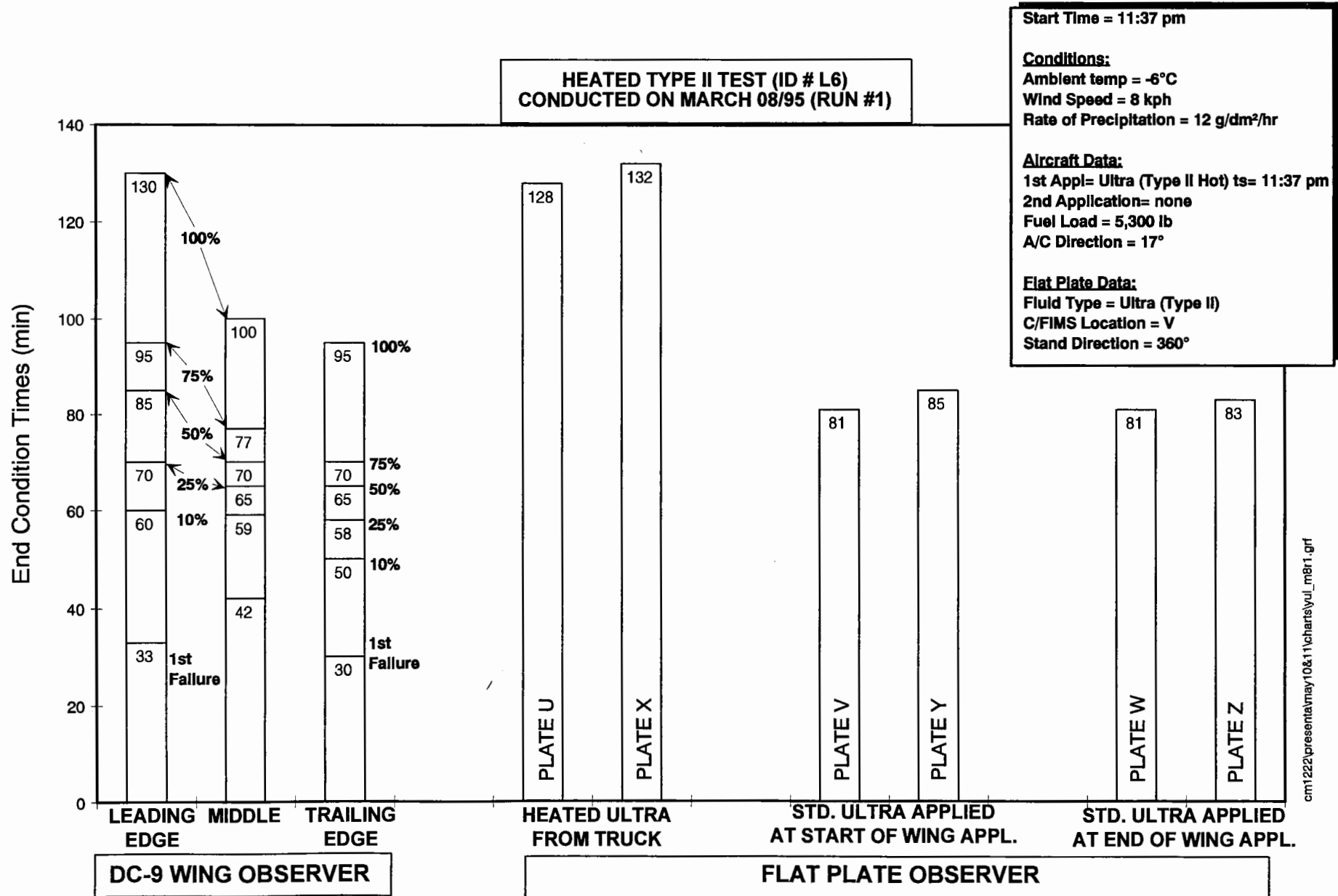

2. SIMULTANEOUS AIRCRAFT AND FLAT PLATE TESTS

- 3) The standard procedure in these and previous flat plate tests involved application of Ultra fluid onto the flat plates by pouring. This method of application may produce plate surface coverage different enough from that resulting from spraying to influence failure times.

- 4) The rather lengthy time lapse between the start of Type I and Type II application, combined with moderate to high rates of precipitation may have contributed to early wing failures. Failures may have occurred on the Type I fluid below the Ultra coating.

These concerns evolved from observations during the actual tests and from subsequent analysis of test data when it was seen that results were clearly not what was expected. Preparation for future tests will need to ensure that the de-icing vehicles assigned to the test are properly equipped to spray Ultra fluid. Similarly, spray technique must ensure that care is taken to achieve complete and consistent coverage over the entire wing surface, and that inordinate delays between application of de-icing fluid and anti-icing fluid do not occur.

The standard procedure of applying Ultra fluid on plates by pouring versus spraying must be investigated to determine whether method of application has an influence on time to failure. A test procedure comparing results of fluid application methods on flat plates (spraying directly from the de-icing truck versus pouring from a container) would be useful. A method of positioning one or more flat plates on the aircraft wing surface thereby allowing the plate to be sprayed as part of the wing de-icing operation could be considered.

Because of these problems further tests will be conducted in the future.

2.8 Aircraft Fluid Failure Times vs Weather Conditions

2.8.1 Analysis of the Influence of Rate of Precipitation on the Aircraft Failure Times

Figures 2.14 through 2.16 show the failure times for first, 10% and 25% of leading edge/trailing edge/mid-wing on the aircraft vs rate of precipitation, respectively. Looking at all three figures, one can see a general trend in the scatter with fluid failure times generally decreasing as the rate of precipitation increases. This trend is as expected and agrees with the results that APS has obtained over the years in flat plate holdover time tests. The one YYZ point at a rate of 2 g/dm²/hr (well above the others), occurred at a temperature above freezing.

2.8.2 Influence of Outside Air Temperature on Aircraft Failure Times

Based on the limited data, no trend can be conclusively identified.

2.8.3 Influence of Wind Speed on Aircraft Failure Times

A weak correlation between fluid failure and wind speed may be evident in the data. The observed trend indicates increase in fluid failure times with an increase in wind speed. More testing is required to be able to confirm the apparent positive effect on de-icing fluid failure times from moderate winds. As commented earlier, while wind may have an effect on keeping the fluid on the aircraft, it can also have an adverse effect from a greater snow "catch due to impact" on certain aircraft surfaces, such as head winds on wing leading edge.

FIGURE 2.14
AIRCRAFT 1st FAILURE vs. RATE OF PRECIPITATION

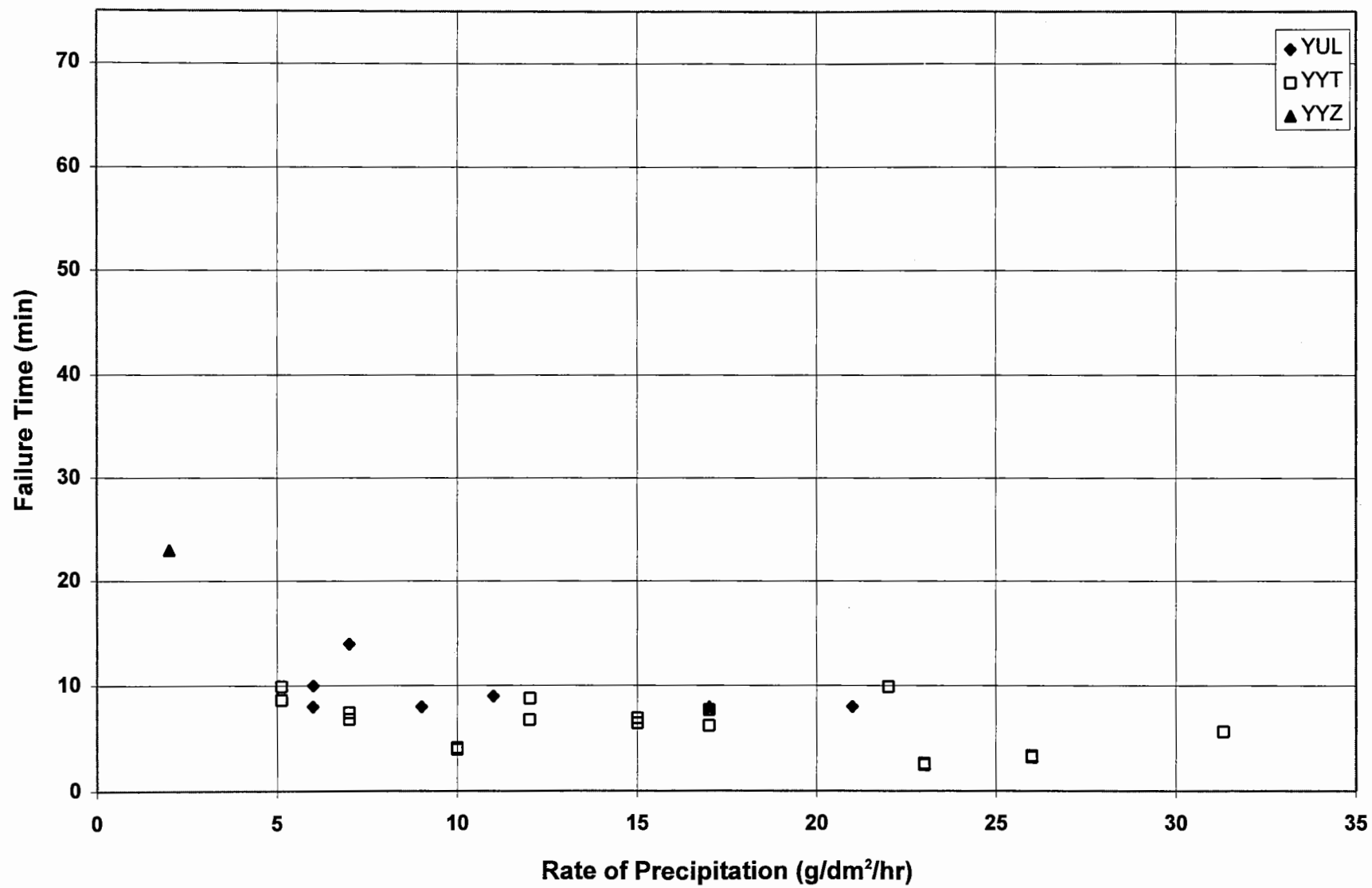
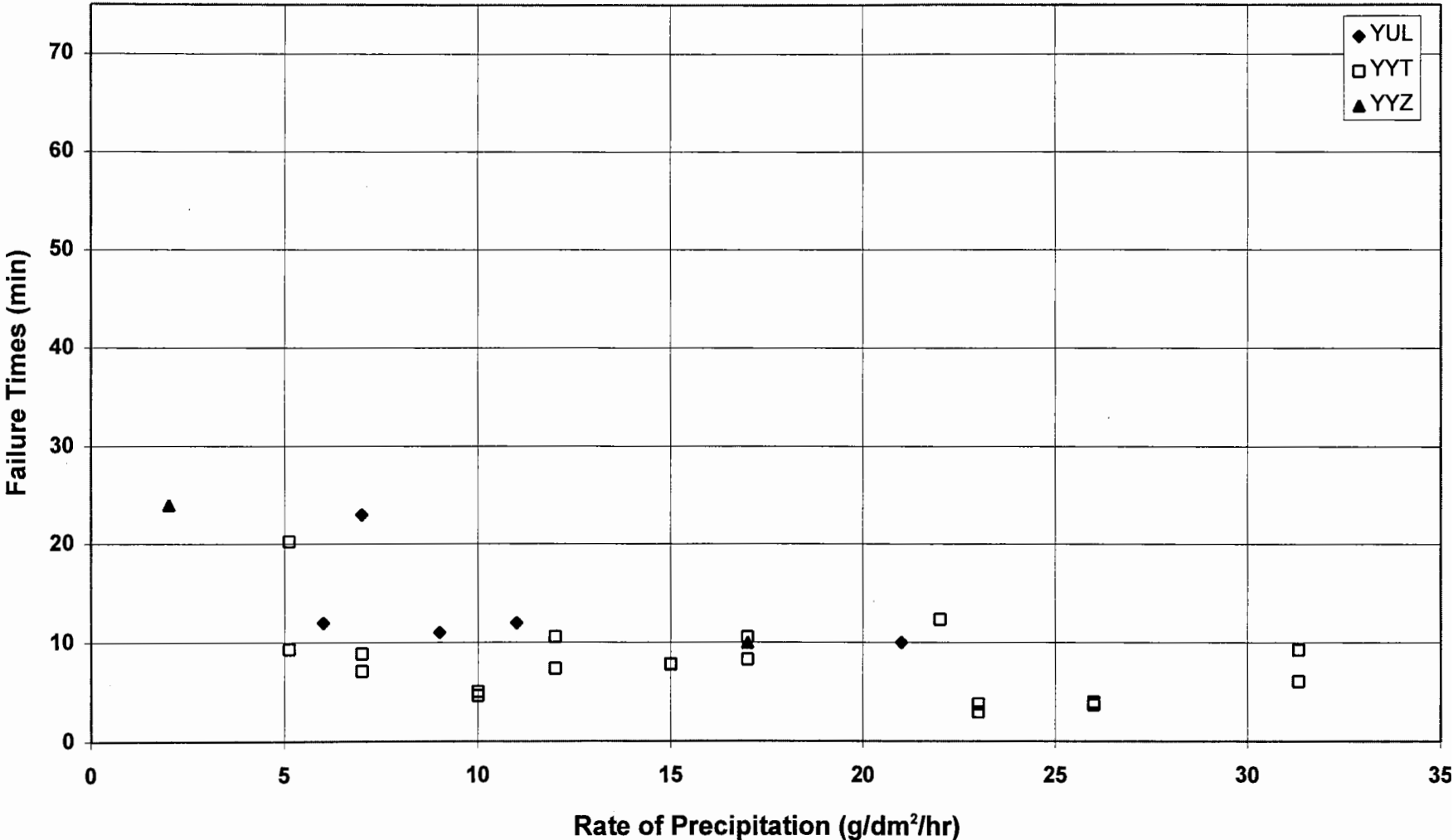
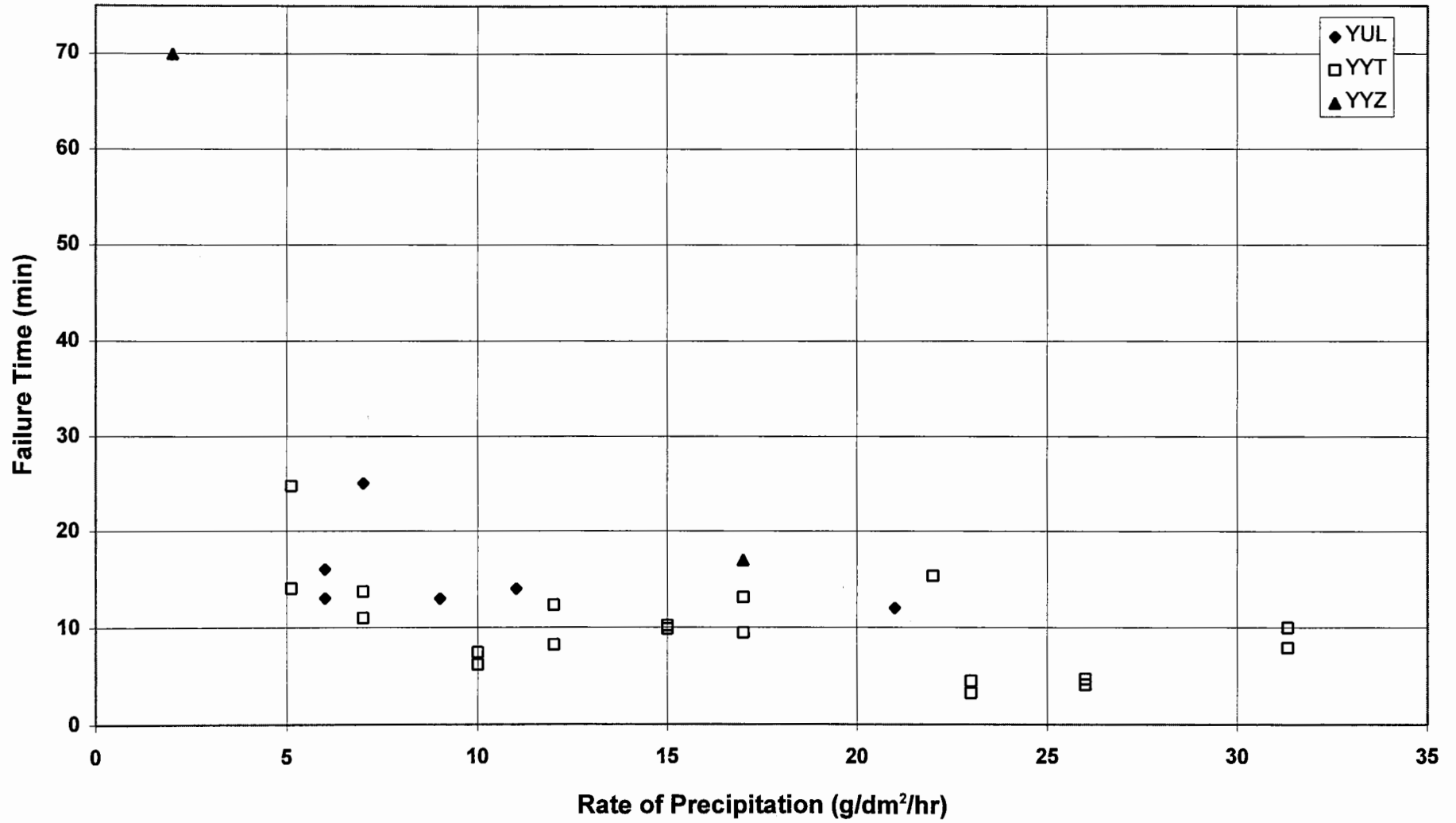

FIGURE 2.15
AIRCRAFT 10% of LE/TE/M vs. RATE OF PRECIPITATION



50

FIGURE 2.16
AIRCRAFT 25% of LE/TE/M vs. RATE OF PRECIPITATION



2.9 Observations on Test Procedures

Identification of fluid failure presented some challenges. Because a number of observers at different sites are involved, it is important to train all observers uniformly on common procedures to ensure consistency in monitoring and identifying fluid failure.

While there is a standard failure definition for freezing rain and one for snow, identification of fluid failure is more difficult during mixed conditions. Results of tests conducted during changing conditions or combinations of precipitation types contribute to the scatter in data values.

In initial tests at St. John's where observers were located in fixed position at the leading edge, it was sometimes difficult to identify the first fluid failure on the trailing edge due to visibility reduction during blowing precipitation, distance, and size of area of failure involved. In these tests, first failures may have occurred on the trailing edge more often than recorded. Failures using the 10% leading edge/trailing edge/mid wing area criteria were easier to identify. Accurate failure identification requires situating observers at both the leading and trailing edges.

3. FLUID THICKNESS DURING TAKE-OFF

3.1 Procedures

3.2 Test Results

3.3 Observations

3. **FLUID THICKNESS DURING TAKE-OFF**

3.1 **Procedures**

One fluid shearing test during take-off was conducted at Mirabel Airport in Montreal. Both the right and left wing surfaces of a CanAir Cargo Boeing 737-200 were utilized. An Aeromag 2000 de-icing vehicle was used to apply Type II Ultra fluid over both the right and left wings in the areas where two C/FIMS sensors were installed. A single C/FIMS sensor was installed on each wing, located at 65% chord from the leading edge, inboard from the engine. The fluid thinning dynamics during the taxi and take-off run were recorded by C/FIMS. The test consisted of the following:

1. Start C/FIMS data logging;
2. Application of anti-icing fluid on aircraft wing;
3. Taxi to the runway in preparation for roll and take-off;
4. Accelerating down the runway: roll and take-off;
5. The aircraft begins rotation and becomes airborne; and
6. The C/FIMS system automatically turns off.

3.2 Test Results

The test was conducted March 23, 1995 after nightfall under clear skies with no precipitation. Wind condition was calm, and ambient temperature was -1°C.

Figures 3.1 through 3.6 contain the fluid thickness history profiles logged by the C/FIMS set-up. The right wing data is plotted in Figures 3.1 and 3.2. The left wing data is plotted in Figures 3.3 and 3.4. Both right and left fluid thickness curves are compared in Figure 3.5 and an enlarged view is illustrated in Figure 3.6. In all the enlarged views, the C/FIMS sample points are included. Because frequency of system sampling was six seconds, only six data points were generated during the take-off run. Temperature history profiles generated by this trial are discussed in Section 4.

Since the data logger was not turned on during de-icing, the fluid thickness and wing surface temperature dynamics associated with this procedure was not available. This accounts for the initial reading of approximately 1.4 mm at the beginning of each fluid thickness curve. Referring to Figure 3.4, the six sample points describe the fluid thickness conditions during taxiing, roll and take-off. The duration of the aircraft taxiing ends at the first data point from the left. Between the second and fifth data points, the aircraft is accelerating. Aircraft rotation occurs during the sixth data point. After lift-off, C/FIMS automatically shuts down and terminates the test. This data point sequence of events is also applicable to Figure 3.4 and 3.6.

Figure 3.1

FLUID THICKNESS ROLL-OFF AT MIRABEL: RIGHT WING

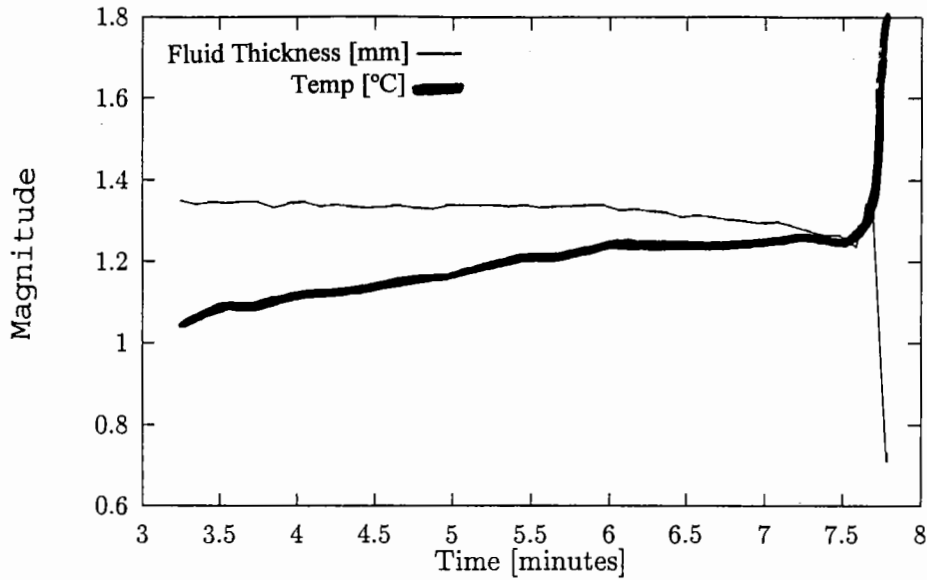

Figure 3.2

**FLUID THICKNESS ROLL-OFF AT MIRABEL: RIGHT WING
DURING TAKE-OFF RUN**

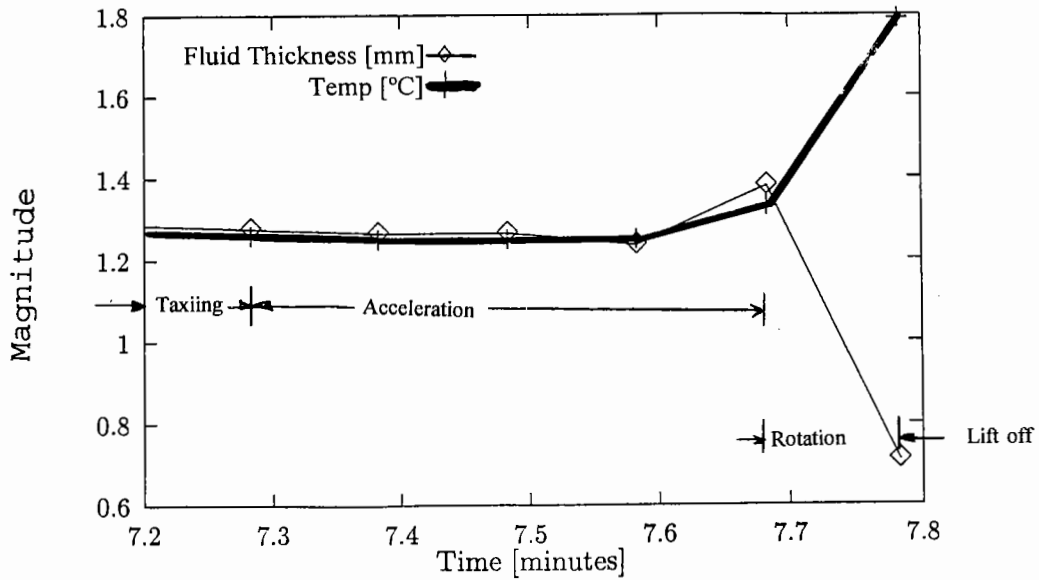

Figure 3.3

FLUID THICKNESS ROLL-OFF AT MIRABEL: LEFT WING

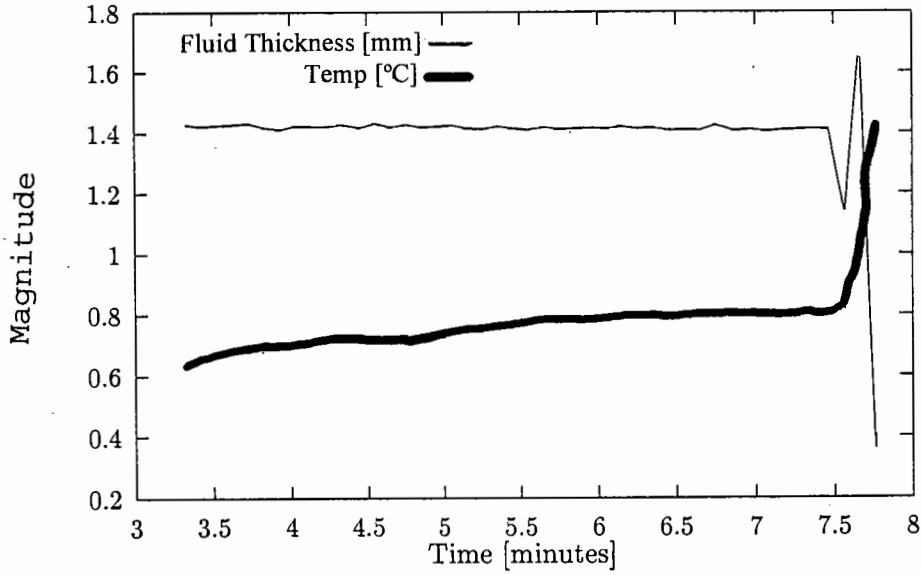

Figure 3.4

**FLUID THICKNESS ROLL-OFF AT MIRABEL: LEFT WING
DURING TAKE-OFF RUN**

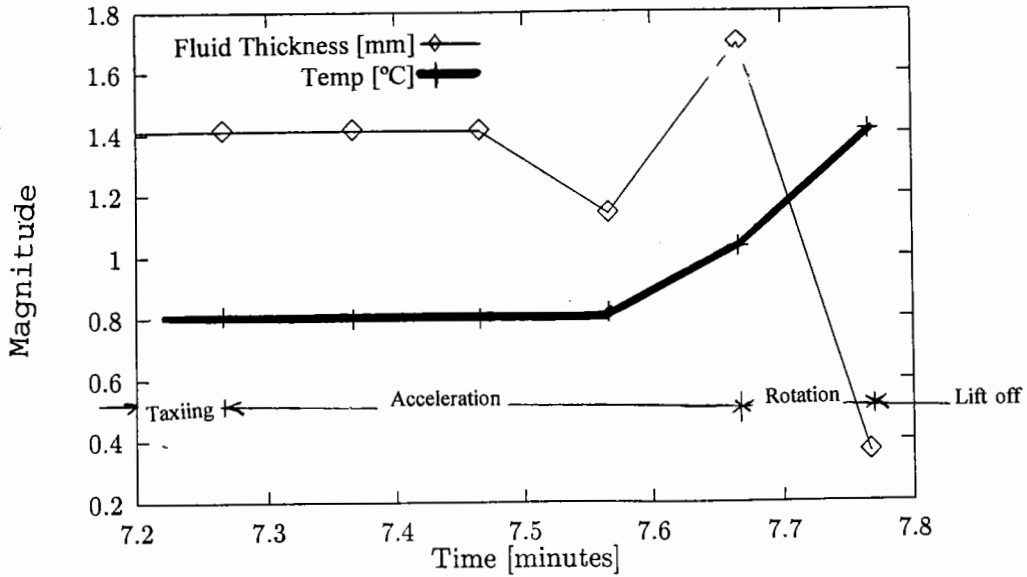

Figure 3.5

**FLUID THICKNESS ROLL-OFF COMPARISON BETWEEN
LEFT AND RIGHT WING**

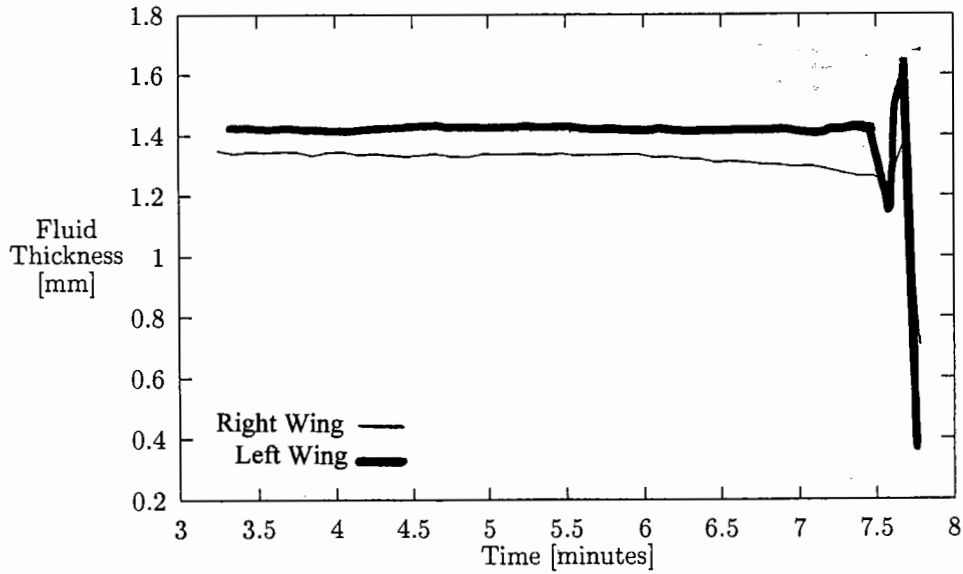
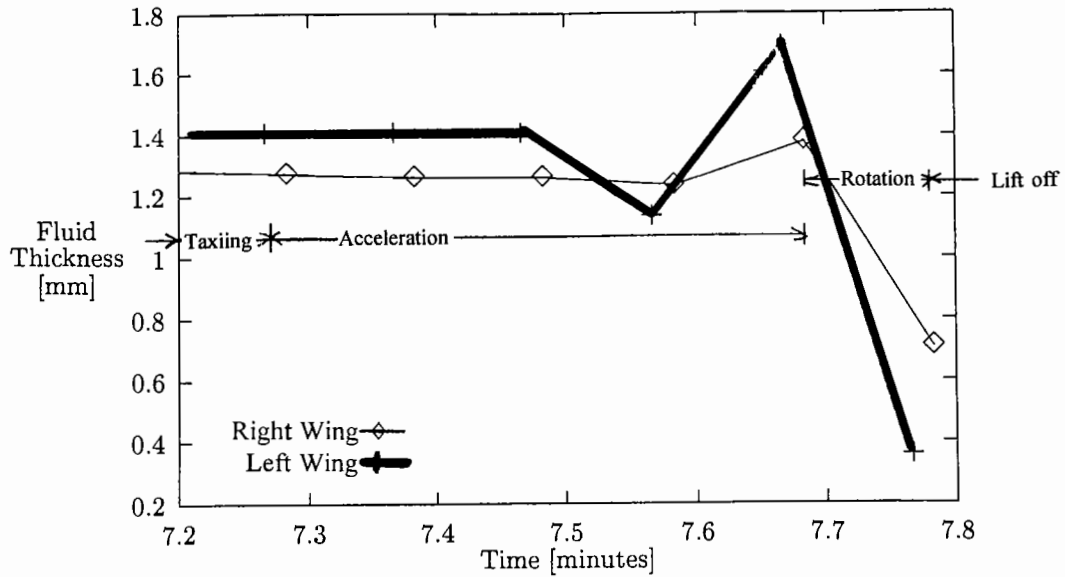

Figure 3.6

**FLUID THICKNESS ROLL-OFF COMPARISON BETWEEN
LEFT AND RIGHT WING DURING TAKE-OFF RUN**



3.3 Observations

1. The following fluid thickness observations can be made:
 - a) Taxiing: Immediately after the fluid application, the data logger was activated. On the right sensor, the fluid thickness was approximately 1.34 mm. On the left sensor, the fluid thickness was approximately 1.43 mm (refer to Figure 3.1 and Figure 3.3 respectively). Towards the end of the taxiing procedure, the fluid measured by the right sensor thinned to approximately 1.26 mm. The fluid measured by the left sensor, however, did not significantly thin. This can be observed in Figure 3.2 for the right wing and in Figure 3.4 for the left wing.
 - b) Acceleration:
 - i. At the beginning of the acceleration procedure, the fluid began to thin slightly. The right sensor fluid layer thinned from 1.26 mm to approximately 1.23 mm and the left sensor fluid layer thinned from 1.41 mm to approximately 1.14 mm.
 - ii. Towards the end of take-off, the fluid thickness increased. The right sensor detected a 1.33 mm layer of FPD fluid flowing over the aircraft wing and the left sensor detected a 1.69 mm layer of fluid flowing over the aircraft wing.
 - c) Rotation: during the rotation manoeuvre, the fluid thickness levels thinned to 0.71 mm on the right sensor and 0.36 mm on the left sensor.

3. FLUID THICKNESS DURING TAKE-OFF

In comparing the fluid thickness profiles, consider Figures 3.5 and 3.6. During taxiing, the sensor readings indicated that the de-icing fluid remained at the same thickness and therefore that the fluid did not flow off the wing during this phase. During acceleration, readings indicated that the fluid on both wings became thinner, then followed briefly by a thicker layer of fluid over the sensor head. This occurred at the fifth sample point. Finally, during rotation, the fluid became increasingly thin.

- d) It should be noted that the thickness readings were taken in specific points in time, at six seconds frequency.

During the late stages of acceleration and during rotation wave patterns develop on the fluid surface and can be observed visually. The interaction of the wave length of these patterns, and the frequency of sampling has an influence on the thickness recorded.

This page intentionally left blank.

4. TEMPERATURE HISTORY

4.1 Testing Occasions

4.2 Temperature History Analysis

4. TEMPERATURE HISTORY

4. TEMPERATURE HISTORY

This series of tests was designed to determine the nature of the temperature profile of the wing surface before, during and subsequent to the de-icing spray process. In accordance with SAE 4737 guidelines de-icing fluid is normally applied with the fluid in the truck tank heated to not less than 60°C (140°F).

Tests 1 to 5 listed below, were based on the C/FIMS sensor installed in aircraft wings. In these tests (except the fluid thickness test where temperature was logged during taxi and take-off), the profile was developed on static aircraft. Aircraft surface temperature profile logging commenced prior to start of spray, through the temperature rise resultant from hot fluid application, and continued until the surface again reached ambient temperature. Artificial freezing rain was employed in the Mirabel Full-Scale test, otherwise natural precipitation conditions were involved.

Appendix D contains the aircraft wing temperature measurements collected by Instrumar during full-scale tests in St. John's.

Tests 6 and 7 below, involved recording wing surface temperatures using a hand-held temperature probe, during full-scale aircraft de-icing tests. Figures 4.1 through 4.16 illustrate temperature profile histories of 21 independent de-icing events, conducted as follows:

1. Air Atlantic (1995) Limited (St. John's International Airport):
three de-icing events;
2. Mirabel Airport Full-Scale Tests: two de-icing events;
3. Mirabel Airport Fluid Thickness Test: one de-icing event;
4. Pearson International Airport Full-Scale Tests - February 21, 1995:
two de-icing events;
5. Marquette Michigan Full-Scale Tests: two de-icing events;
6. Dorval Airport Full-Scale Tests, nine de-icing events; and
7. Pearson International Airport Full-Scale Tests - March 26, 1995:
two de-icing events.

Figure 4.1

TEMPERATURE PROFILE: AIR ATLANTIC (1995) LIMITED TEST 1A

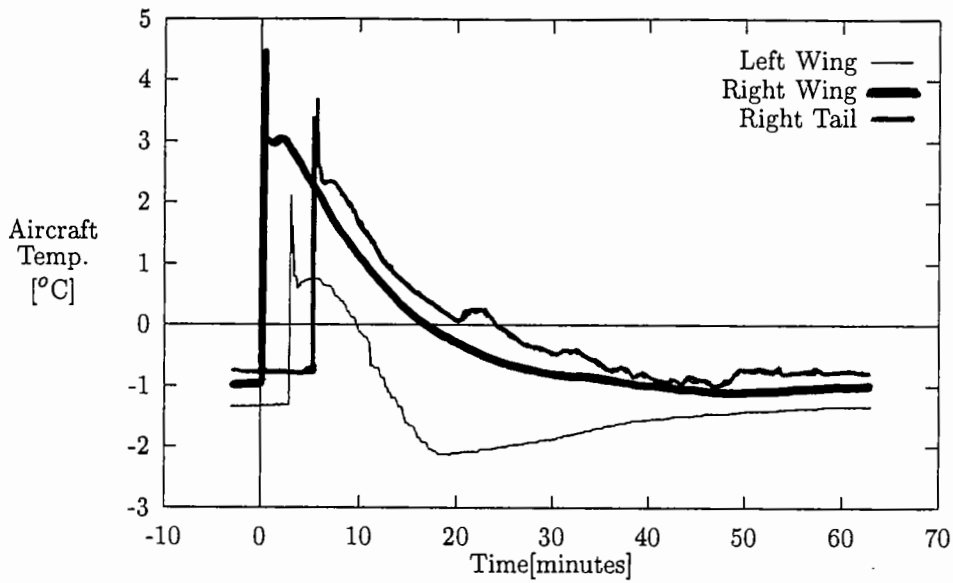

Figure 4.2

TEMPERATURE PROFILE: AIR ATLANTIC (1995) LIMITED TEST 1B

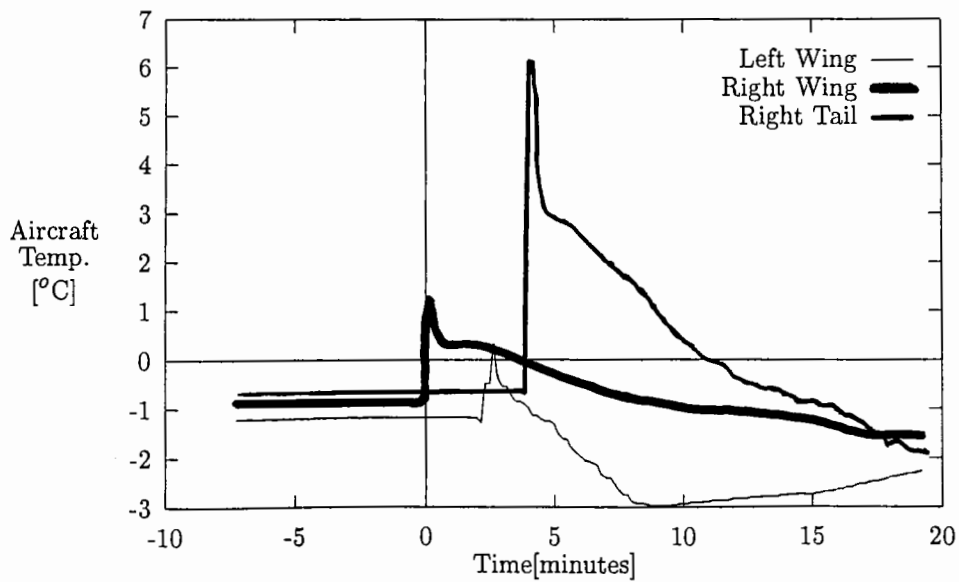

Figure 4.3

TEMPERATURE PROFILE: AIR ATLANTIC (1995) LIMITED TEST 1C

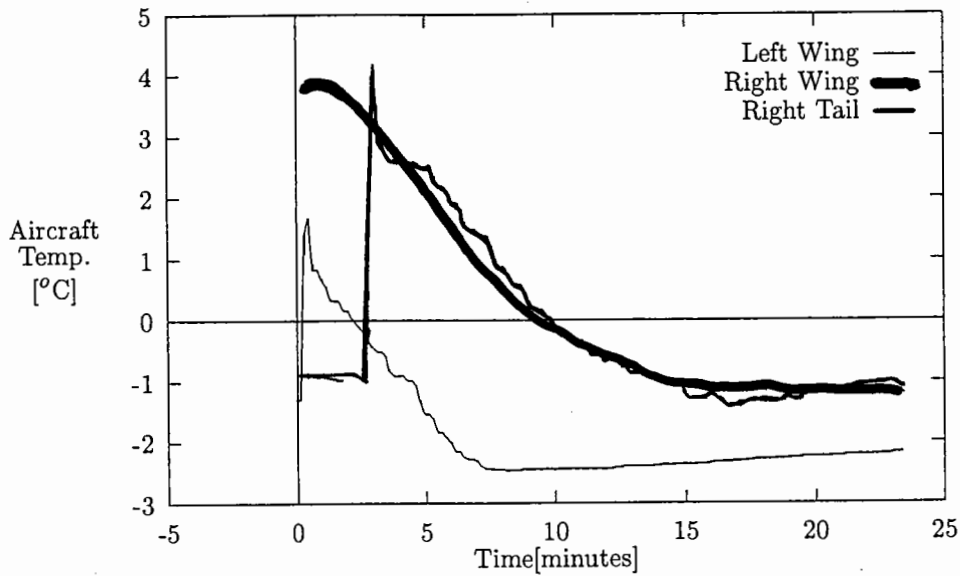

Figure 4.4

TEMPERATURE PROFILE: MIRABEL AIRPORT STATIC TEST 1A
Type I followed by Artificial Freezing Rain

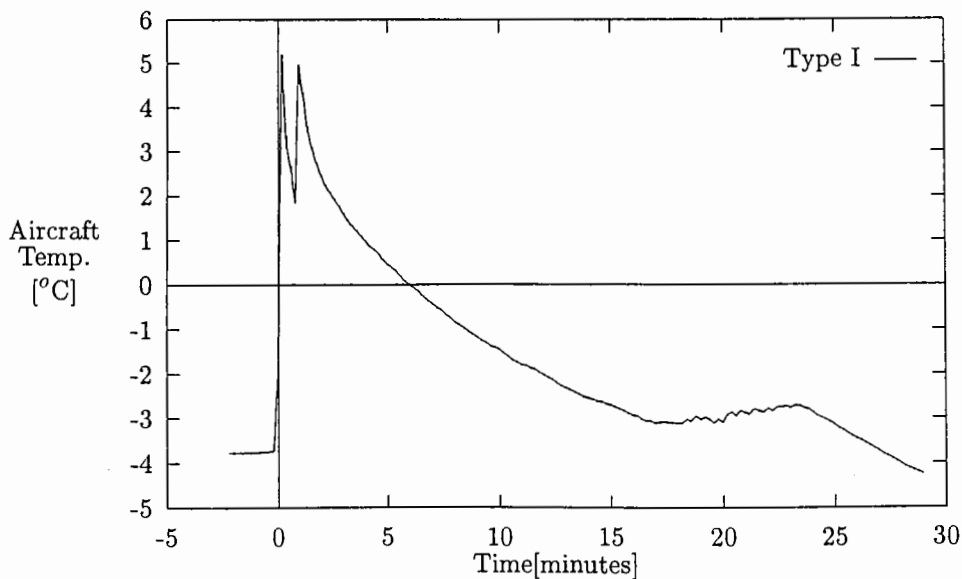

Figure 4.5

TEMPERATURE PROFILE: MIRABEL AIRPORT STATIC TEST 1B

Type I, then Type II followed by Artificial Freezing Rain

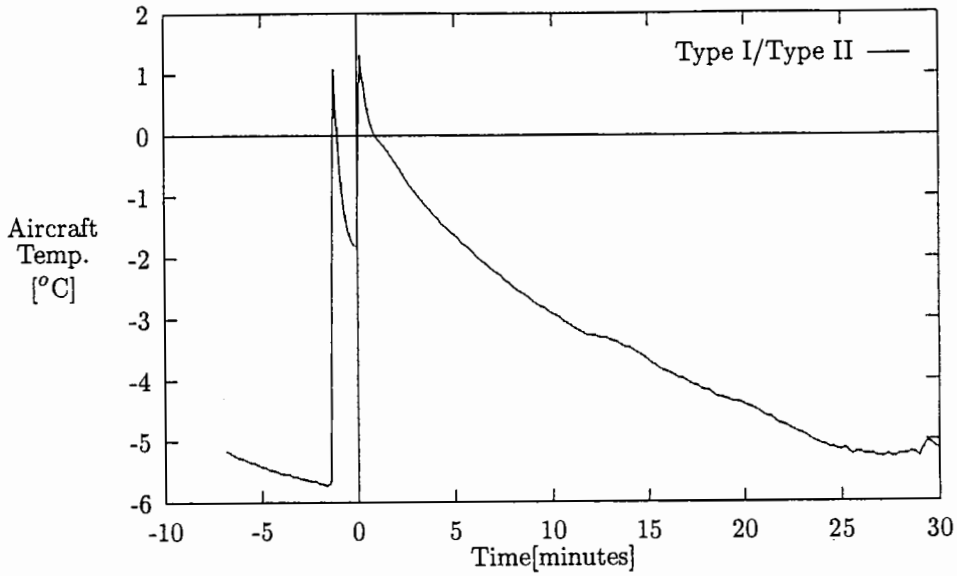

Figure 4.6

TEMPERATURE PROFILE: MIRABEL FLUID THICKNESS TEST

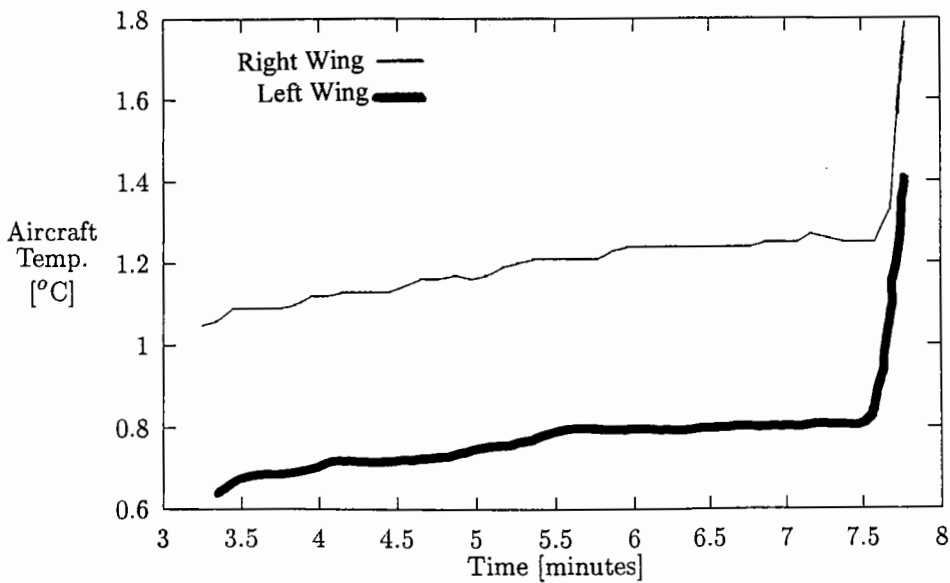

Figure 4.7

**TEMPERATURE PROFILE: PEARSON INTERNATIONAL AIRPORT
STATIC TEST 1A**

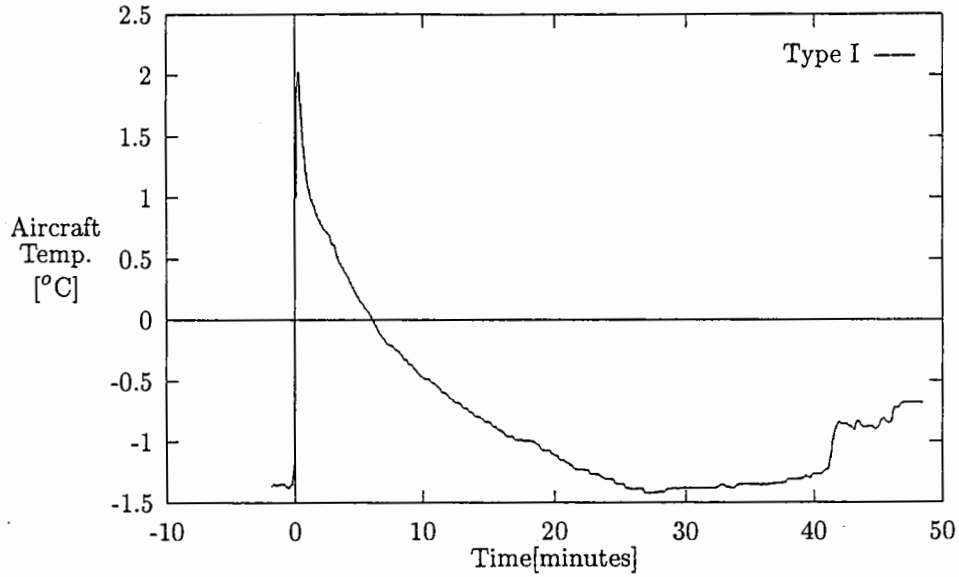

Figure 4.8

**TEMPERATURE PROFILE: PEARSON INTERNATIONAL AIRPORT
STATIC TEST 1B**

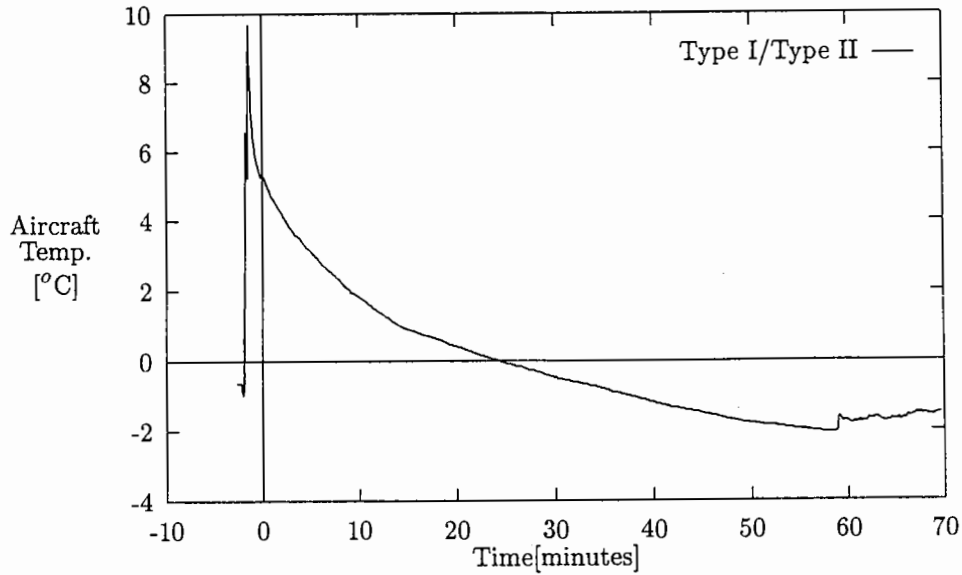

Figure 4.9

TEMPERATURE PROFILE: MARQUETTE MICHIGAN STATIC TEST 1A

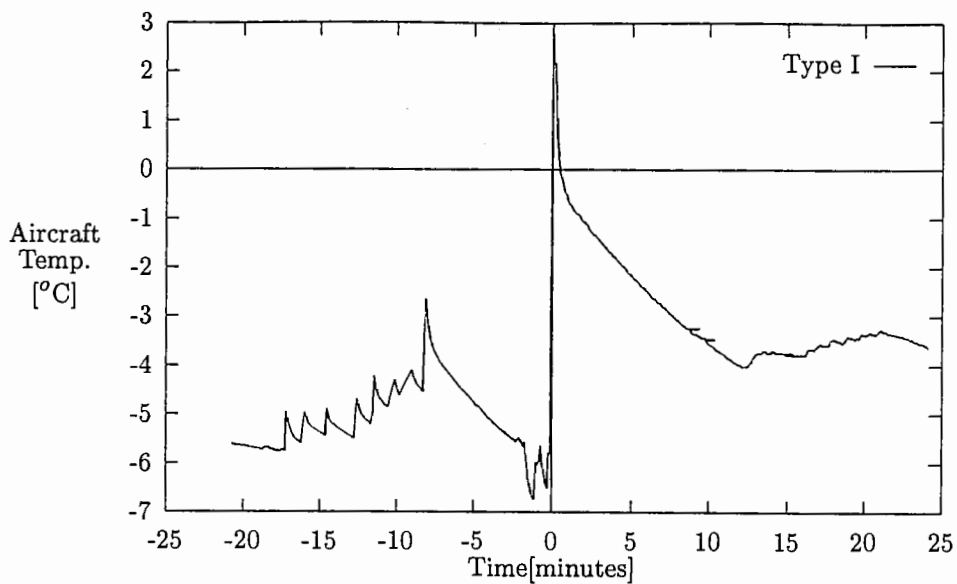

Figure 4.10

TEMPERATURE PROFILE: MARQUETTE MICHIGAN STATIC TEST 1B

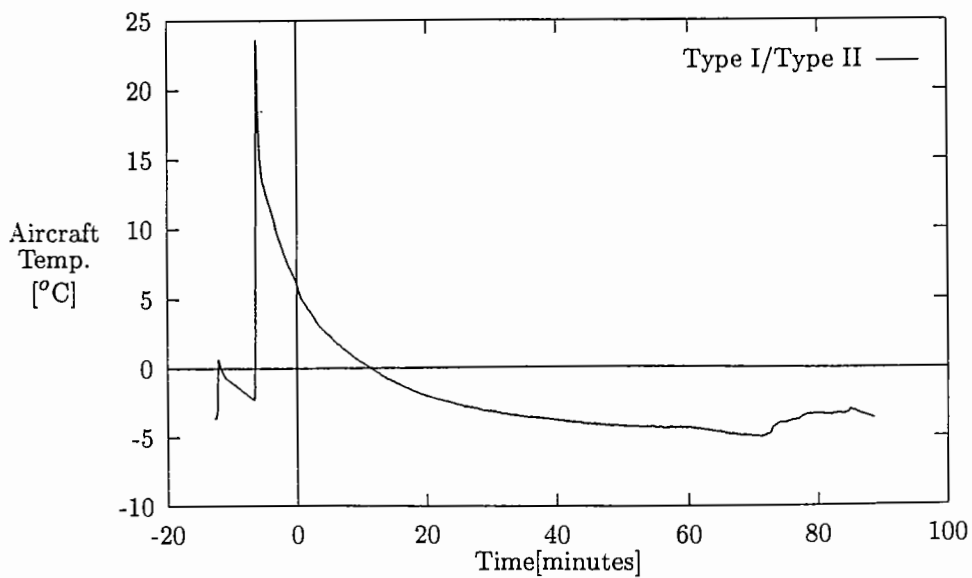

FIGURE 4.11
FULL SCALE TEMPERATURE MEASUREMENT TEST AT YUL
FEBRUARY 24, 1995

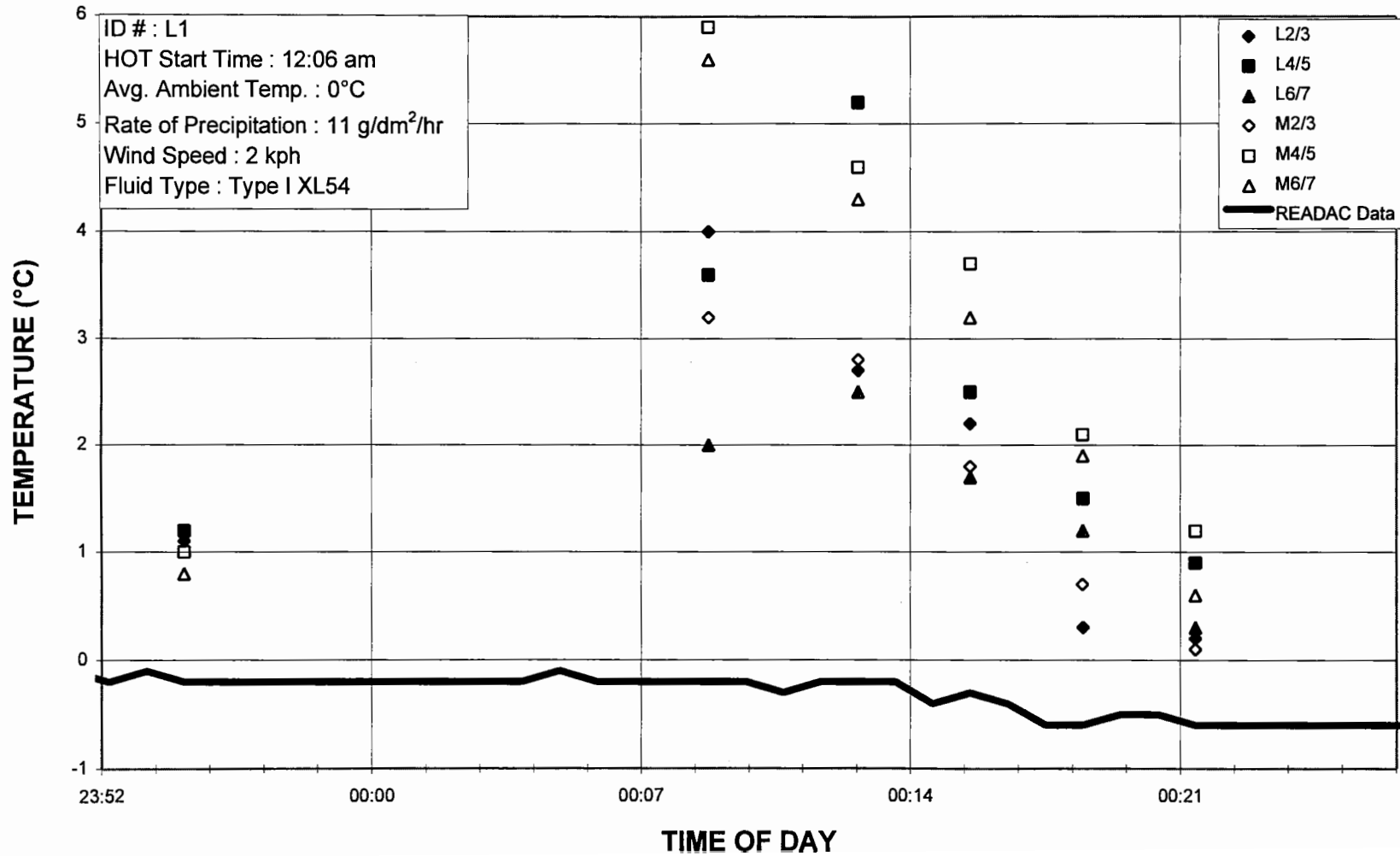

FIGURE 4.12
FULL SCALE TEMPERATURE MEASUREMENT TEST AT YUL
 MARCH 06, 1995

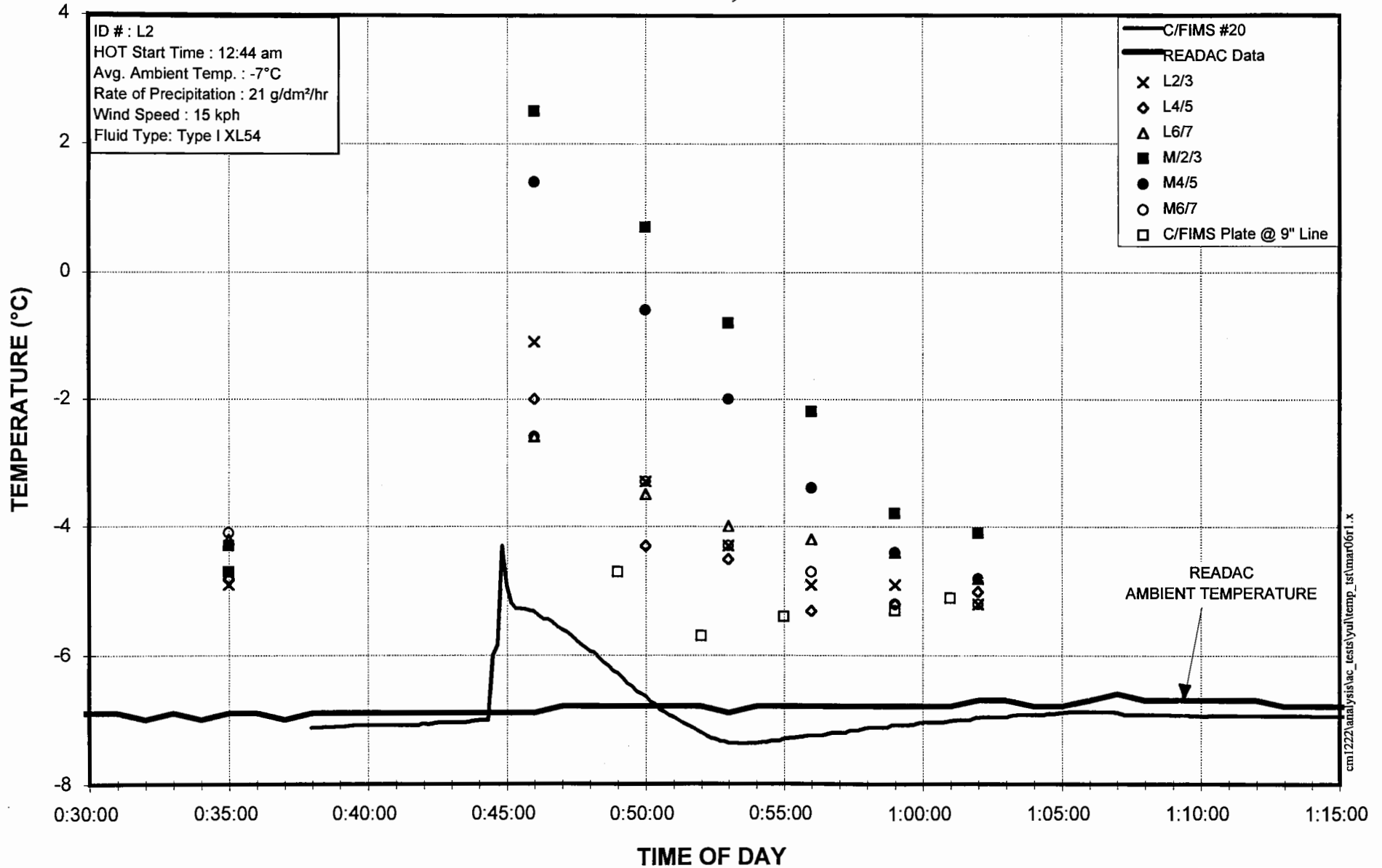

FIGURE 4.13

FULL SCALE TEMPERATURE MEASUREMENT TEST AT YUL

MARCH 06, 1995

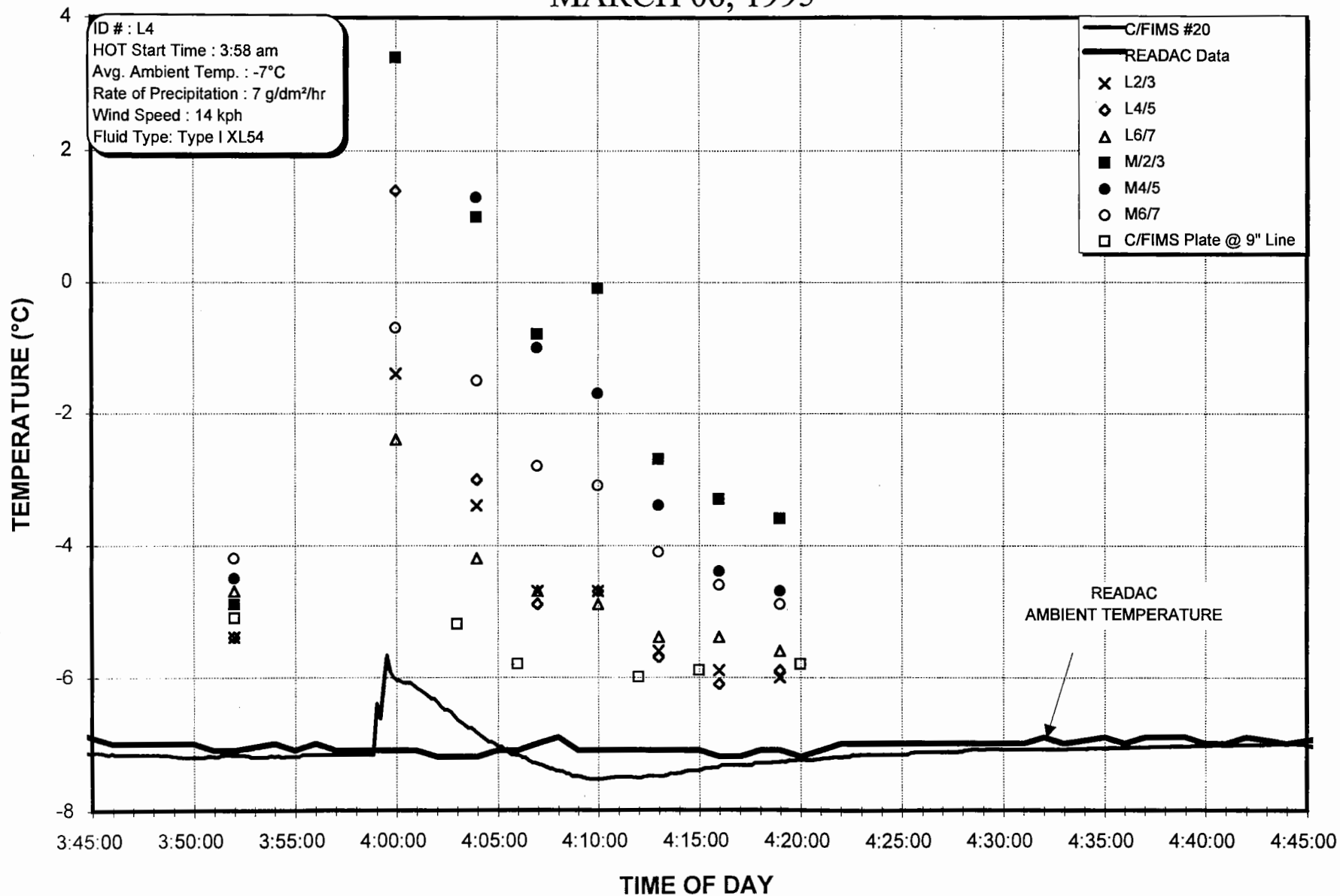
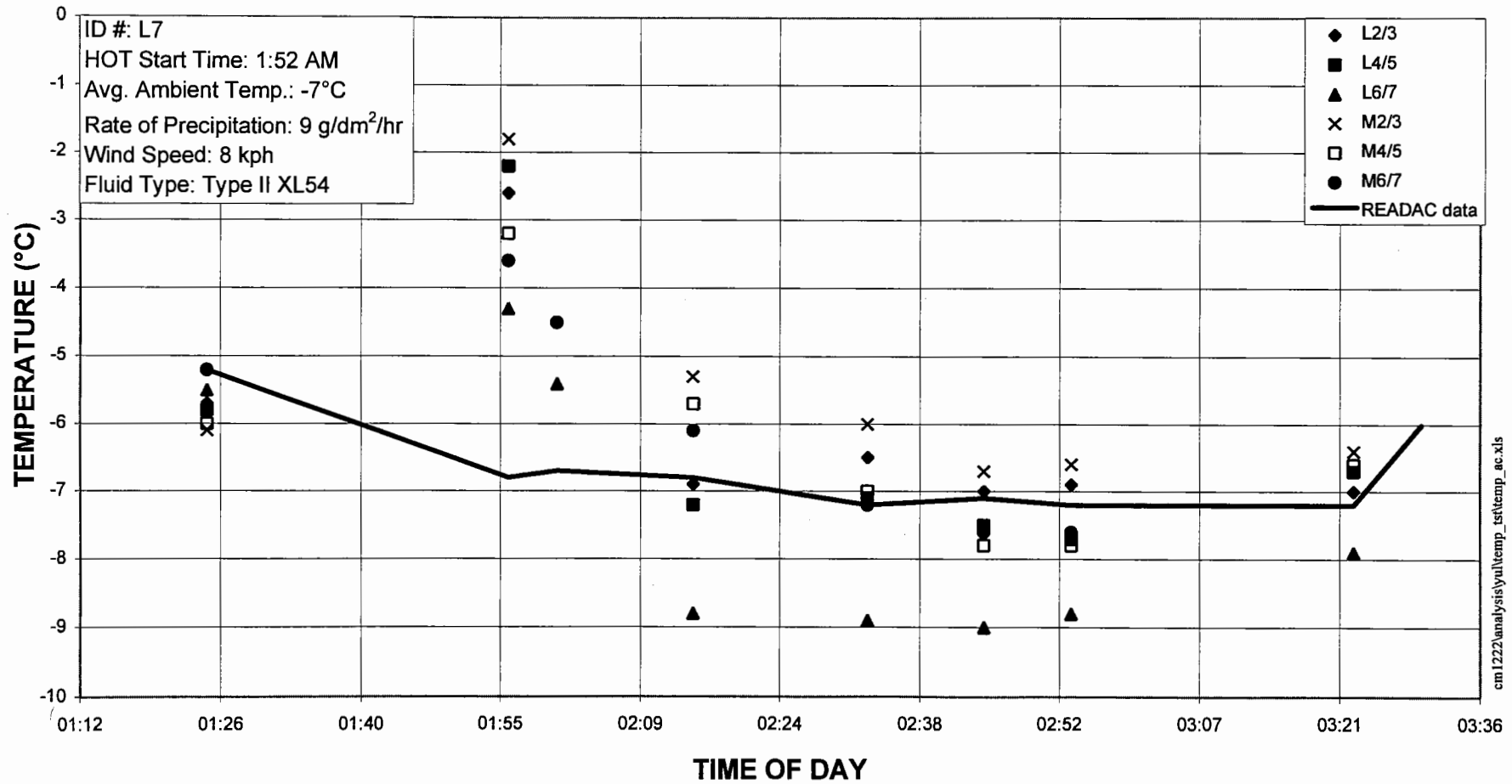

FIGURE 4.14
FULL SCALE TEMPERATURE MEASUREMENT TEST AT YUL
MARCH 08, 1995



70

cm.1222analysis\yul\temp_1st\temp_ac.xls

FIGURE 4.15
FULL SCALE TEMPERATURE MEASUREMENT TEST AT YYZ
FEBRUARY 21, 1995

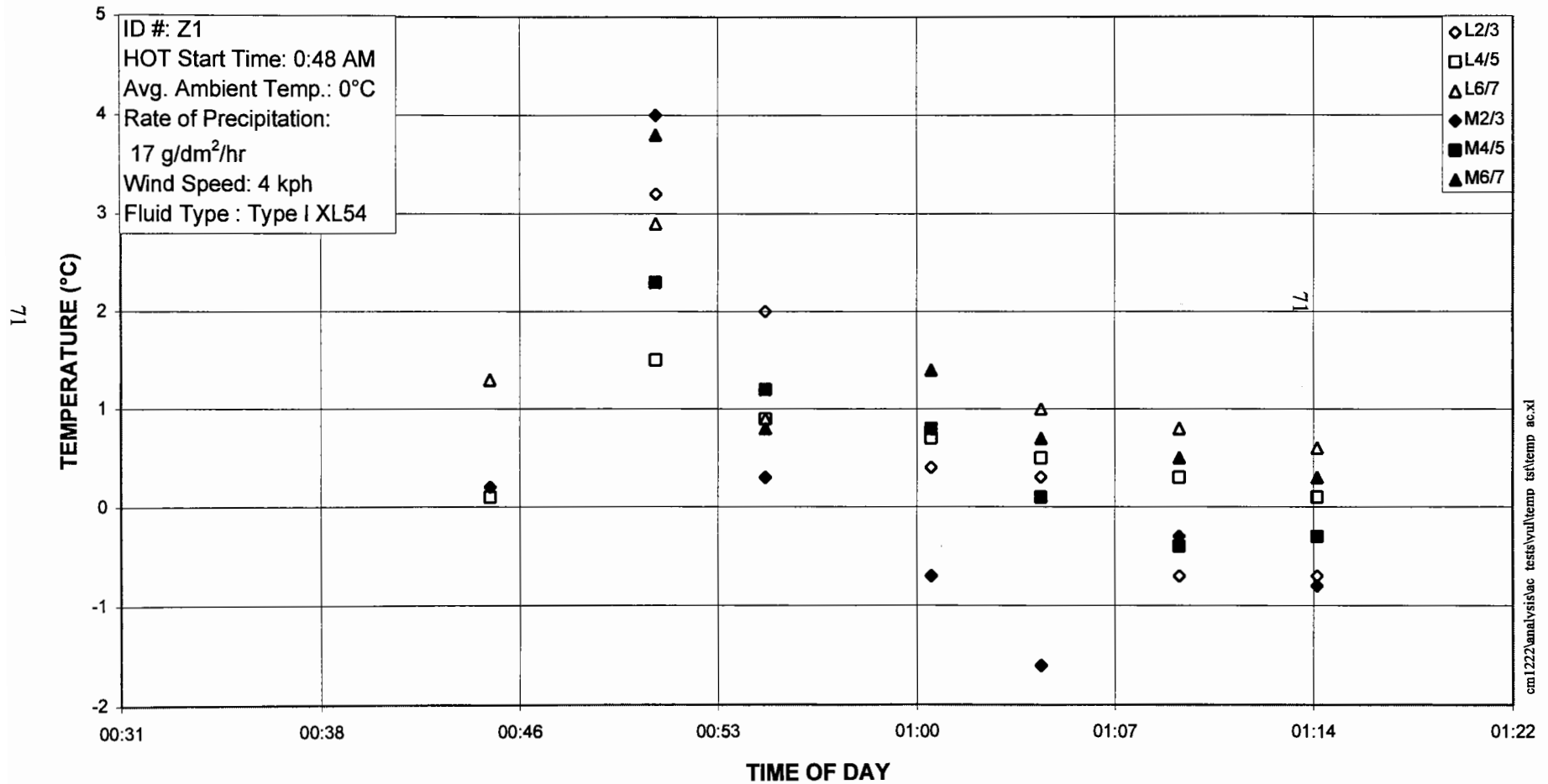
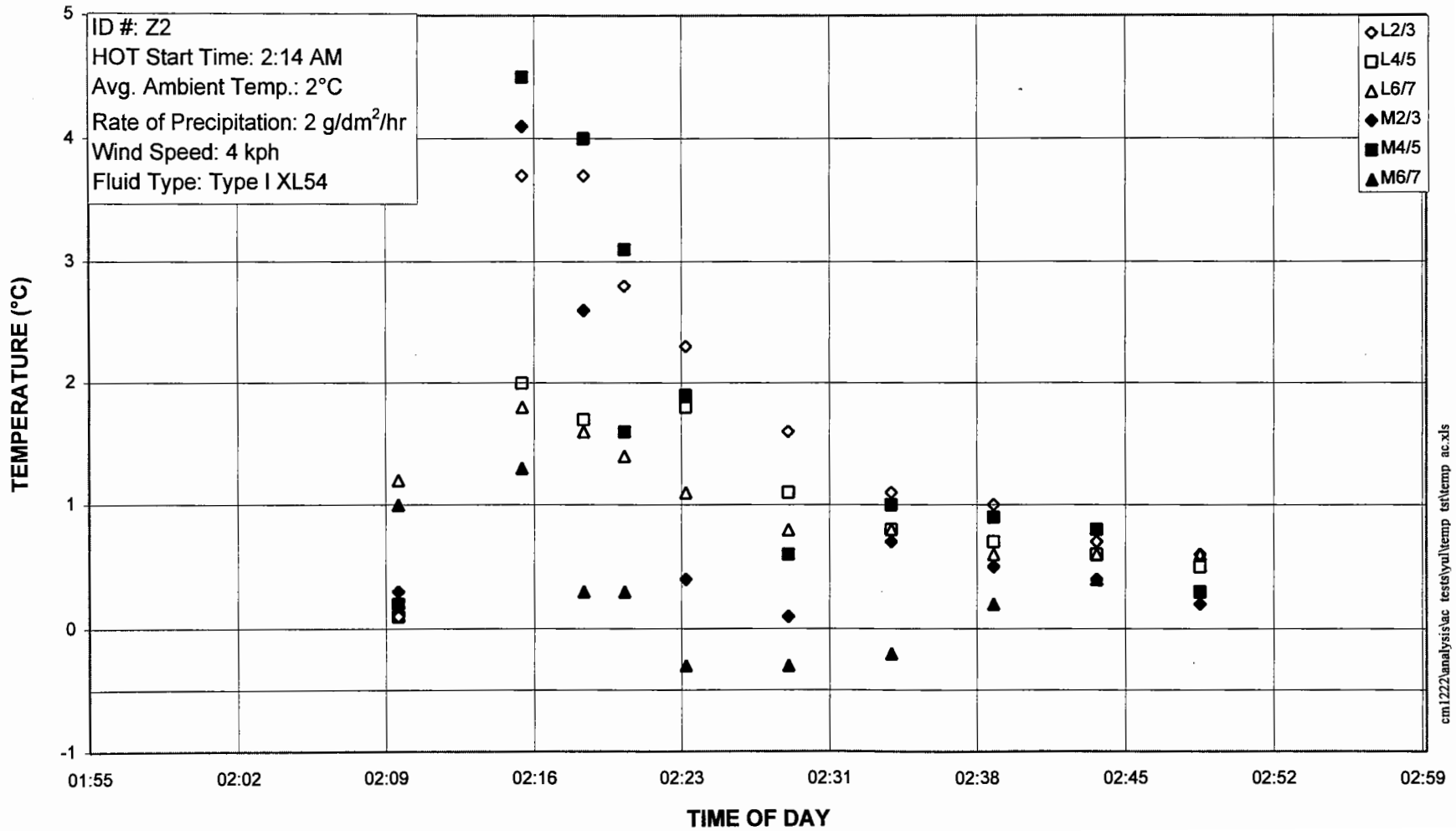

FIGURE 4.16
FULL SCALE TEMPERATURE MEASUREMENT TEST AT YYZ
FEBRUARY 21, 1995



cm1222analysis\ac tests\yul\temp tst\temp ac.xls

4.1 **Testing Occasions and Observations**

4.1.1 **St. John's Newfoundland Full-Scale Test**

This series of full-scale tests was performed at St. John's International Airport, St. John's, Newfoundland, Canada, on Monday, January 23, 1995.

Three tests were conducted on a C/FIMS-installed on an Air Atlantic (1995) BAe-146. The carrier's C/FIMS system incorporated four sensors: one in the left wing tip, one in the right wing tip, one in the left tail section and one in the right tail section. Unfortunately, the left tail C/FIMS sensor was not operational at the time. In all cases, a standard application of Union Carbide XL54 de-icing fluid was used. Fluid application followed the same pattern: right wing, left wing, left tail and then the right tail.

Prior to each test, the aircraft surface was allowed to stabilize close to ambient conditions (approximately -1.0°C). The prevailing winds were about 35 kph from 100° east of north (magnetic north orientation). Moderate snow conditions dominated throughout the tests. During the tests, all ice and snow was removed from the aircraft.

Figures 4.1, 4.2 and 4.3 illustrate the temperature profiles for each test. During test three, the fluid application phase on the right wing was not logged.

4.1.2 Mirabel Airport Full-Scale Test

This full-scale test was performed at Mirabel Airport, Montreal, on March 12, 1995. Two tests were conducted on the right wing of a C/FIMS-installed CanAir Cargo Boeing 737. The C/FIMS sensor was located at 65% chord on the wing inboard from the engine. Prior to each test, the aircraft skin temperature was allowed to reach ambient conditions (-6.6°C and -7.0°C, respectively).

The first test consisted of a standard de-icing application using XL54 Type I de-icing fluid. The wing surface was then exposed to artificial freezing rain. Figure 4.4 illustrates the temperature history of this particular test.

The second test consisted of an application of XL54 Type I de-icing fluid to remove all contaminants on the wing surface. Union Carbide Ultra, an anti-icing fluid, was then applied. Immediately after the anti-icing was completed artificial freezing rain was applied. Figure 4.5 illustrates the temperature history of this particular test.

4.1.3 Mirabel Airport Fluid Thickness Test

Temperature readings were recorded during a fluid thickness measurement test performed at Mirabel Airport, Montreal, on March 23, 1995. This test was conducted after nightfall under clear skies with no precipitation, wind condition was calm, and ambient temperature was -1°C. A CanAir Cargo Boeing 737-200 was utilized in the test.

4. TEMPERATURE HISTORY

Unheated Ultra was applied to both wings over the installed C/FIMS sensors. Figure 4.6 illustrates the temperature history of the test. Figures 3.1, 3.2, 3.3 and 3.4 provide further detail.

The following temperature profile observation can be made:

- a) Taxiing: on both wings, the temperature profiles tend to increase during taxiing. The increase appears to be uniform and consistent between the two sensors. The approximate 0.4°C difference between the two temperature profiles may be a result of other factors, such as, aircraft wing temperature differences before fluid application.
- b) Accelerating: in both cases, during the acceleration portion of the test there is a temperature increase. On the right wing section, there is a temperature rise of 0.21°C from the taxiing temperature (refer to Figure 3.2). On the left wing section, there is a temperature rise of 0.08°C from the taxiing temperature (refer to Figure 3.4).
- c) Rotation: during rotation, there is a further temperature increase. On the right wing section, there is a temperature rise of 0.59°C (refer to Figure 3.2). On the left wing section there is a temperature rise of 0.54°C (refer to Figure 3.4).

4.1.4 Pearson International Airport Full-Scale Tests Feb 21, 1995

Two tests were performed at Toronto's Pearson International Airport. The tests followed the same procedure as the Dorval tests described in Section 4.1.7. The temperature probe data for these tests is shown in Figures 4.15 and 4.16. The C/FIMS sensor was not available for the Toronto testing.

4.1.5 Pearson International Airport Full-Scale Test March 26, 1995

A full-scale test was performed at Pearson International Airport, Toronto, overnight March 26/27, 1995. Two tests were conducted on the right wing of a C/FIMS-installed CanAir Cargo Boeing 737. The aircraft skin temperature was allowed to reach ambient temperature (-1.0°C) prior to each test.

The first test consisted of an application of XL54 de-icing fluid using standard de-icing procedures. Artificial freezing rain immediately applied after the fluid application. Figure 4.7 illustrates the temperature history of this particular test.

The second test consisted of an application of XL54 Type I de-icing fluid to remove all contaminants on the wing surface. Ultra was then applied. Again standard de-icing procedures were used. This test was conducted under no precipitation conditions. Figure 4.8 illustrates the temperature history of this particular test.

4.1.6 Marquette Michigan Full-Scale Test

This full-scale test was performed at Marquette Airport, Marquette, Michigan, on the evening of April 14, 1995 and ended on the morning of April 15, 1995. Two tests were conducted on the left wing of a Midway Fokker F-100 which had C/FIMS sensors installed at the 10% chord (leading edge) on the inner wing. Prior to each test the aircraft was allowed to stabilize on the tarmac to allow the aircraft skin temperature to reach ambient conditions (-5°C and -6°C, respectively).

The first test consisted of an application of freezing rain on the sensor and surrounding area. XL54 de-icing fluid was then applied using standard de-icing procedures. All the ice build-up on the aircraft was removed. Freezing rain precipitation was immediately started after the fluid application was completed. Figure 4.9 illustrates the temperature history of this particular test.

The second test consisted of an application of XL54 de-icing fluid to remove all contaminants on the wing surface. Ultra was then poured on the wing sensor area from a container. This test was conducted under no precipitation conditions. Figure 4.10 illustrates the temperature history of this particular test.

4.1.7 Dorval Airport Full-Scale Tests

A total of nine usable tests were conducted at Dorval Airport under natural snow precipitation conditions. Temperature measurements from the DC-9 wing surface were obtained by a hand-held surface temperature probe. The

locations (eg. L2/3, L4/5) of the measurements on the DC-9 wing are shown on the data form in Appendix A, page A-16. One measurement was also taken on a C/FIMS equipped flat plate on the 9" line as the C/FIMS was operating.

The data for tests L1, L2, L4 and L7 is shown in Figures 4.11 through 4.14. The figures show the wing and plate surface temperature probe measurements in a scatter mode along with two curves. One of the two curves on the charts is the C/FIMS temperature measurements curve and the other is the READAC (Automatic weather station at Dorval) ambient temperature curve. The hand held temperature probe measurements were taken before the de-icing operation had started as the wing's temperature had stabilized and then after the de-icing operation continuously until the test was declared completed. The C/FIMS and READAC measurements were logged continuously throughout the test evening.

4.2 Temperature History Analysis

A common feature of all tests is the temperature increase on the wing skin after the de-icing fluid was applied. That increase was found to be of the order of 5 to 10°C depending on the fluid temperature and amount sprayed. The temperature would then gradually decrease over the test period to stabilize around the original wing skin temperature.

The wing surface C/FIMS curves exhibit a distinctive feature in that they show a region where the slope would change sign. In other words, the temperature change would go from a decreasing to an increasing trend and eventually stabilize around the original skin temperature. This fluctuation lasted anywhere from ten minutes to one

4. TEMPERATURE HISTORY

hour depending on the environmental conditions and cannot be attributed to electronic noise. This trend was also seen to occur in flat plate tests on the flat plate mounted C/FIMS and is believed to be caused by the change of phase of the de-icing fluid as it becomes diluted by the precipitation and starts to freeze.

Initial wing temperature measurements taken prior to spraying showed that none of the wings were in a cold soaked condition.

The series of tests conducted at Dorval Airport with hand-held probes showed that these probes do deliver reasonable and consistent data. This was best illustrated from results of probe temperature measurements taken on the flat plate on which a C/FIMS sensor was mounted. Very similar temperature values and profile were produced from the two instruments, although the distinct region on the curve developed from C/FIMS sensor data (change of slope from decreasing to increasing) was not identified by hand-held probe data. The similarity of instrument data concurs with findings of the "Hot Water De-icing Trials for the 1994-1995 Winter"³ where thermistor probes were attached to the wing surface to log temperature on a continuous basis.

The aircraft surface temperature experienced a much greater increase than that of the flat plate, and time to cool back down to ambient took much longer than the flat plate, indicating a greater degree of heat transfer into the wing. Different locations on the wing showed significant variation in temperature gain and time to cool down, reflecting findings of the Hot Water Trials which measured time to cool subsequent to spraying with hot water as a function of ambient temperature and wind condition.

3

"Hot Water De-icing Trials for the 1994-1995 Winter", TP 12653E, APS Aviation Inc., December 29, 1995, 48 p.

This page intentionally left blank.

5. CONCLUSIONS

- 5.1 Comparison of Fluid Failure Times between Aircraft Surfaces and Flat Plates**
- 5.2 Failure Progression on the Wing**
- 5.3 Adequacy of the Representative Surface and Visibility of Wing Contamination from Inside the Cabin**
- 5.4 Impact of Environmental Conditions on Fluid Failure Times**
- 5.5 Fluid Thickness Profile During Take-Off and Roll**
- 5.6 Wing Temperature Profiles During De-Icing**
- 5.7 General Observations on Test Procedure**

5. CONCLUSIONS

5. CONCLUSIONS

Conclusions are presented in point form as they pertain to particular objectives of the study as identified in the introduction: correlation of fluid failure times on aircraft surfaces on flat plates; failure progression on the wing; adequacy of the representative surface; impact of environmental conditions on fluid failure times; fluid failure criteria and test procedural concerns; fluid thickness profile during take-off; and wing temperature profiles during de-icing.

5.1 Comparison of Fluid Failure Times between Aircraft Surfaces and Flat Plates

1. For Type I XL54 fluid, it can be concluded that the flat plate holdover times are equivalent to the failure of about 10% or less of the entire wing area, and that flat plates offer satisfactory representation of aircraft wing surfaces in holdover time trials for Type I fluids.

These results are supported by findings from United Airlines' trials at Denver Airport.

2. Results of the three tests performed with UCAR Ultra Type II Neat fluid did not confirm that flat plates offer a satisfactory wing representation. The aircraft wings were observed to fail much earlier than expected and earlier than the flat plates. Specific factors associated with the fluid application were believed to contribute to early failure:

- Use of a spray nozzle installed for use with Type I fluids;

5. CONCLUSIONS

- A delay between the first application of Type I and subsequent Type II application under high rates of precipitation with risk of failure of the Type I fluid;

- The Ultra fluid was sprayed with the de-icing truck operating from behind the wing, which left areas of sparse coverage on the leading edge evident in video records; and

- Pouring of the Ultra fluid onto the flat plates as opposed to spraying onto the aircraft wing may produce different fluid thickness. Future testing of Ultra on flat plates should include trials of spray application to investigate this possibility.

Commentary

The above concerns evolved from observations noted during the actual tests and from subsequent analysis of test data.

As lack of snow conditions limited the number of tests conducted on Ultra fluid to three (which produced unexpected results), a further series of tests will be required to satisfy the program objective. Preparation for further tests must ensure that the de-icing vehicles assigned to the test are properly equipped to spray Ultra fluid, that the spraying operation results in complete and consistent coverage over the entire wing surface, and that inordinate delays between application of de-icing fluid and anti-icing fluid do not occur.

The standard flat plate test procedure in which fluid is applied by pouring (as opposed to spraying) must be investigated to determine whether this influences time to failure for Ultra fluid. A test procedure involving a sprayed application of fluid directly onto plates by the de-

5. CONCLUSIONS

icing vehicle would provide the clearest test results for comparative purposes. A method of positioning one or more flat plates on the aircraft wing surface thereby allowing the plate to be sprayed as part of the wing de-icing operation could be considered.

This experience points out the need for particular care in the application of Ultra fluid during normal winter operations. Attainment of the full potential of Ultra fluid is very dependent on the use of suitably equipped de-icing vehicles and application by knowledgeable operators fully trained in spray techniques unique to Ultra.

5.2 Failure Progression on the Wing

1. Flight control systems such as ailerons, flaps, slats and spoilers are well defined sections of the aircraft wing and present sharp edges upon which fluid failure can initiate and spread. The trailing edge and the leading edge appear to be the most failure sensitive regions due to the presence of flight control surfaces and surface discontinuities. The same was observed for a small portion of the middle section of the DC-9 wing where a raised area formed a surface discontinuity and caused early first failure. However, this patch did not cause failure progression. This being a feature of a DC-9 wing, one cannot generalize such observations to all aircraft wings and consider the patch location as a failure sensitive area.
2. Fluid failure on the wing was seen to generally progress from the point of first failure. In general, the trailing edge and leading edge would fail first, and the mid-chord section would follow. This is a reflection of fluid thinning at the leading and trailing edges and downstream from any surface discontinuities such as the forward edge of flight control surfaces. The nose of the leading edge was sensitive to snow build up during a headwind. Full-scale fluid thickness tests are planned for the 1995/1996 winter.

5.3 Adequacy of the Representative Surface and Visibility of Wing Contamination from Inside the Cabin

1. The representative surface does not present itself as a conclusive representation of the condition of the aircraft wing surface as earlier failure occurred elsewhere on the wing about 70% of the time. Failure on the representative surface was simultaneous with the rest of the wing 15% of the time, and was earlier 15% of the time. The events of earlier failure are related to the DC-9 aircraft having a raised patch within the representative surface which caused fluid thinning. Selection of optimum locations to serve as representative surfaces must be viewed as being aircraft specific, with locations selected according to wing geometry and visibility from inside the cabin.
2. Throughout the Dorval full-scale tests, an observer (a pilot when available) was positioned in the cabin to track failure occurrence and progression. Most failure calls from this position lagged the calls of outside observers by several minutes. In many instances, the cabin observer completely missed a fluid failure patch when it occurred on the far half of the wing because of insufficient lighting, heavy precipitation causing low visibility, or glare. A video camera with zooming capability did not alleviate this problem. Accepting that glare from external lights may have had some influence, further work on identifying appropriate lighting and surface paint schemes to optimize the ability to identify fluid failures from the cabin is recommended.

5. CONCLUSIONS

5.4 Impact of Environmental Conditions on Fluid Failure Times

1. As would be expected and in agreement with past APS flat plate holdover time testing results, fluid failure times decrease with increasing rates of precipitation.
2. Recognizing the constraints of limited data, the test data indicates that there may be an increase in fluid failure times in the 15 to 25 kph wind speed interval. This would agree with past APS flat plate holdover time tests which indicated that moderate winds (15 to 25 kph) may have a positive effect on flat plate holdover times.

5.5 Fluid Thickness Profile During Take-Off and Roll

1. Fluid thickness recorded by C/FIMS sensors installed in each aircraft wing showed Type II fluid thinning during the acceleration run, followed by a thicker layer of fluid passing over the sensor surface, and final thinning during rotation. Frequency of sensor sampling was six seconds, limiting ability to identify any rippling of fluid on the wing surface. There was no evident loss of fluid during the taxi phase, indicating that any environmental impact would be limited to the runway area.

5.6 Wing Temperature Profiles During De-Icing

A particularly significant observation was the time delay before temperature returned to below zero and consequently to pre-de-icing temperature suggesting that a significant contribution of Type I fluid to anti-icing protection derives from the heat input to the wings.

1. Temperature profiles as measured by both the left and right wing C/FIMS sensors exhibited similar features throughout all three phases of the take-off and roll procedure. There was a slight but consistent temperature increase during the taxiing phase, and a sharper temperature rise during the acceleration and rotation phases.
2. The series of tests conducted at Dorval Airport with hand-held probes showed that these probes do deliver reasonable and consistent data. This was best illustrated from results of probe temperature measurements taken on the flat plate on which a C/FIMS sensor was mounted. Very similar temperature values and profile were produced from the two instruments. This concurs with findings reported elsewhere where thermistor probes were attached to the wing surface to log temperature on a continuous basis.
3. Aircraft wing surface temperature experienced a much greater increase than that of the flat plate, and time to cool back down to ambient took much longer than the flat plate, indicating a greater degree of heat transfer into the wing. Different locations on the wing showed significant variation in temperature gain and time to cool down, reflecting findings of the Hot Water Trials which measured time to cool as a function of ambient temperature and wind.

5. CONCLUSIONS

5.7 General Observations on Test Procedure

Conducting tests at more than one site, particularly when sites are geographically distant, requires particular attention to ensure that differences in procedures and interpretation of observations do not occur.

This can be controlled by installing common test procedures at all sites based on a single test procedures document, and by providing a common trainer for all sites. Monitoring initial tests at all sites by a single test authority would ensure consistency and conformance with the standard procedure.

This page intentionally left blank.

6. RECOMMENDATIONS FOR FUTURE TESTING

6. **RECOMMENDATIONS FOR FUTURE TESTING**

This section outlines the direction and scope for future testing.

1. For Type I fluid tests it was found that approximately 10 % or less of the entire wing surface had failed when the flat plates were considered failed. These results confirm those observed by United Airlines. No further testing is deemed necessary.

The question as to whether up to 10% of the wing surface area represents an acceptable level of contamination needs to be addressed and will be the subject of future NRC research.

2. As tests on Type II Ultra fluid were limited to three (and produced unexpected results associated with application procedures), further tests will be required to finalize the objective of comparing fluid performance on the aircraft to performance on flat plates. Future tests must ensure that test deicing vehicles and spray procedures are suited to spraying of Ultra fluid.

These tests should examine the standard test procedure of applying fluid onto flat plates by pouring as opposed to spraying, for influence on results. As well, any influence of applying Ultra fluid on top of Type I fluid, either in a clean or contaminated state, should be examined.

3. Further investigate the viewing of aircraft representative surfaces from the cabin, and the adequacy of the representative surface concept for live operations.

6. RECOMMENDATIONS FOR FUTURE TESTING

4. Investigate and test different lighting and paint schemes of the wing surface to identify the optimum solution to enhanced visibility of failures from inside the cabin.

5. Conduct further fluid shearing tests with C/FIMS mounted aircraft to study the effect of fluid thickness with Ultra Plus at all dilutions (Neat, 75/25, 50/50) with and without precipitation.

6. Develop a video training module on application of Type II fluids to be made available to industry users. Include a description of the unique characteristics of the fluid that require special application techniques, for the general education of hands-on de-icing operators as well as all those involved in de-icing throughout the industry.

APPENDIX A
APS TEST PROCEDURES

**EXPERIMENTAL PROGRAM
FOR SIMULTANEOUS AIRCRAFT VS PLATE TESTING
1994 - 1995**

APS Aviation Inc.

January 31, 1995
Version 1.4

**EXPERIMENTAL PROGRAM
FOR SIMULTANEOUS AIRCRAFT VS PLATE TESTING
1994 - 1995**

This document provides the detailed procedures and equipment required for the conduct of simultaneous aircraft vs plate testing for the 1994/95 winter season.

1. OBJECTIVE

To **correlate the flat plate** test data used to substantiate the SAE Holdover Time Tables with the **performance of fluids on service aircraft**, by concurrently testing de/anti-icing fluids on standard flat plates and service aircraft under conditions of natural freezing precipitation for Type I and Type II fluids during the 94/95 winter season.

Aircraft will be made available for testing outside regular service hours, between 23:00 hrs. and 06:00 hrs. Aircraft types to be used will be representative of those in use by major airlines in Canada. Test programs will be conducted at Toronto, Pearson International Airport, using aircraft provided by Canadian International; at Dorval Airport, using aircraft made available by Air Canada; and in St. John's, using aircraft to be negotiated by DCIP. Figure 0 shows a schematic of the test locations at three airports.

2. TEST REQUIREMENTS (PLAN)

Attachment Ia provides the list of tests to be conducted at Toronto and Dorval during natural snow conditions while Attachment Ib provides the list of test to be conducted at St. John's during natural freezing rain conditions.

3. EQUIPMENT

Test equipment required for the simultaneous aircraft vs flat plate tests is provided in Attachment II. Details and specifications for some of the equipment is provided in the experimental plan developed for Dorval's flat plate testing "Experimental Program for Dorval Natural Precipitation Testing 1994/95" (*FPTP*).

4. PERSONNEL

Up to nine personnel are required to conduct tests for each occasion. A description of the responsibilities and duties of each of the personnel is provided as guidelines in Attachment III. Depending upon the weather forecast at the site, the number of personnel will be reduced or increased, but it will not exceed ten. Figure 1 shows a schematic of the positioning of the test personnel. Ground support personnel from the airlines will be available to apply fluids, position the aircraft and facilitate the inspection of the critical aircraft surfaces.

5. PROCEDURE

The test procedure is included in Attachment IV.

6. DATA FORMS

The data forms are listed below:

- Figure 3 General Data Form
- Figure 4 Aircraft Data Form
- Table 1 from the *FPTP*

**FIGURE 0
SCHEMATIC OF TEST LOCATIONS**

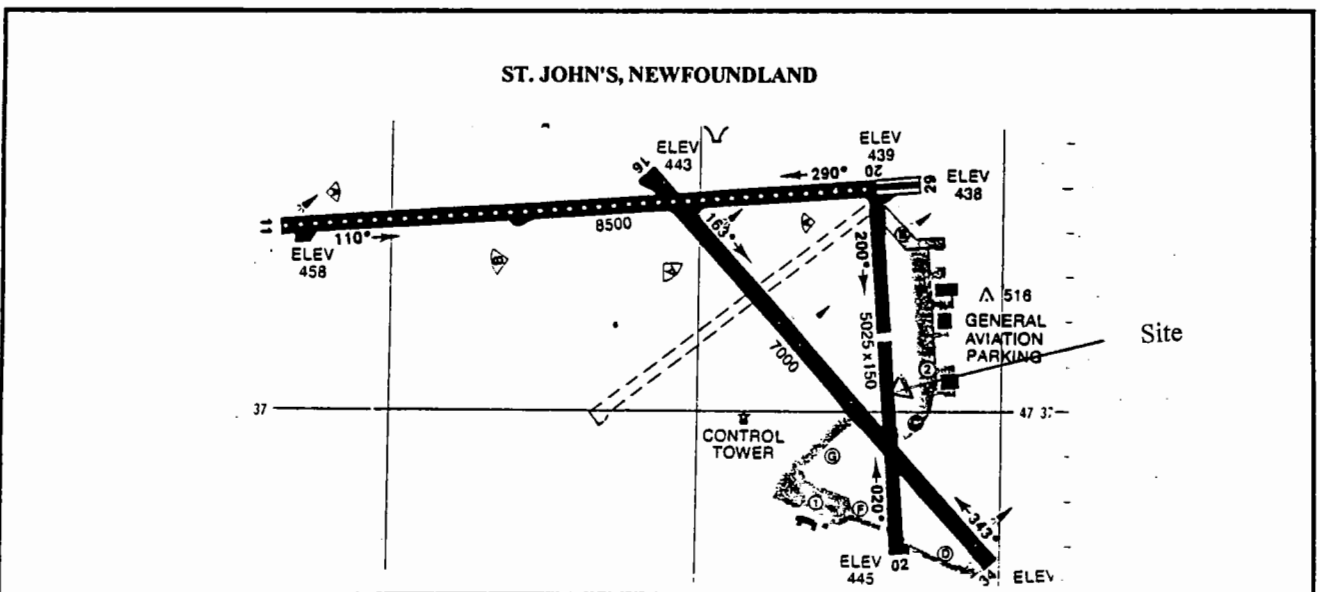
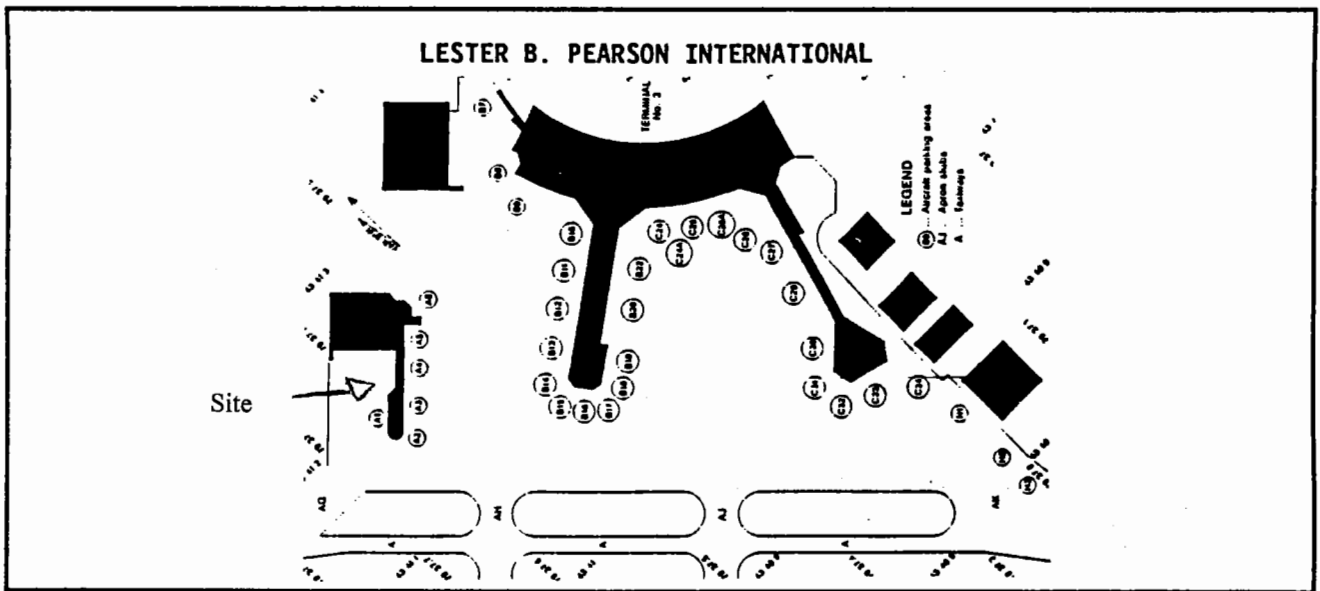
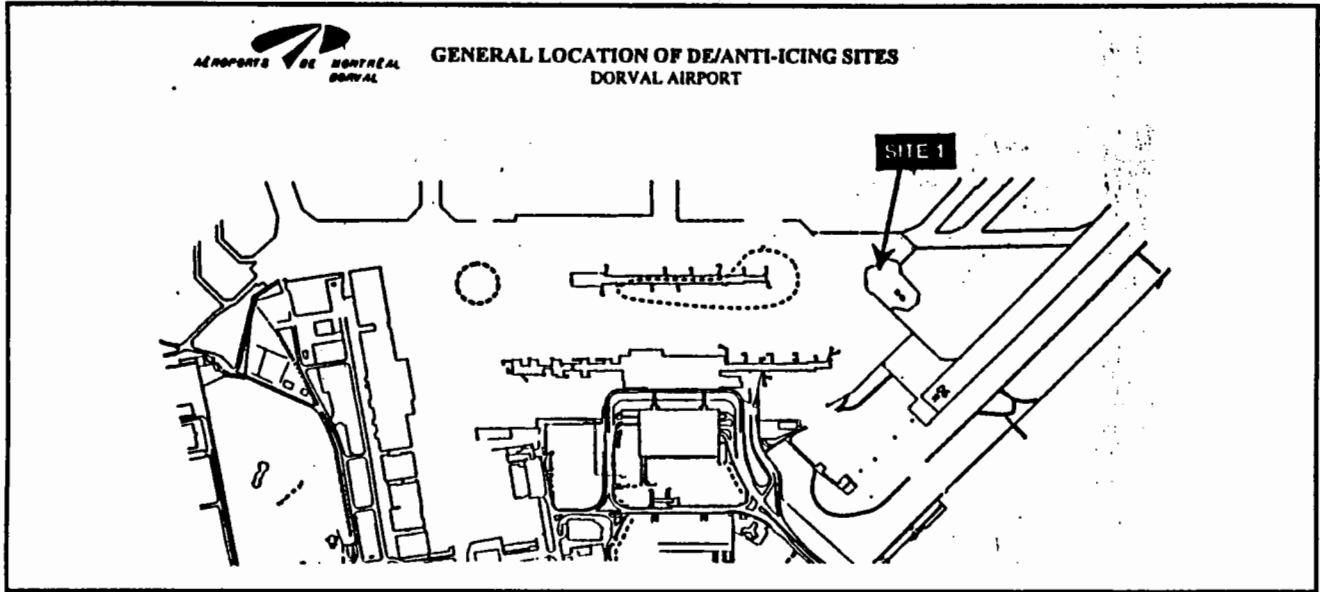

ATTACHMENT Ia
TEST PLAN FOR
SIMULTANEOUS AIRCRAFT vs PLATE TESTS AT YUL & YYZ
NATURAL SNOW CONDITIONS

RUN #	OCCASION #	NUMBER OF PLATES TESTED	PLATES						WING	
			XL54 FROM TRUCK/PAIL	XL54 FROM CONT PRIOR	DIL XL54 FROM CONT PRIOR	ULTRA FROM TRUCK/PAIL	ULTRA FROM CONT PRIOR	ULTRA FROM CONT AFTER	XL54 FROM TRUCK	ULTRA FROM TRUCK
1	1	6	2	2	2				1	
2	1	6	2	2	2				1	
3	1	6	2	2	2				1	
4	1	6	2	2	2				1	
5	1	6	2	2	2				1	
6	1	6				2	2	2		1
7	1	6				2	2	2		1
8	2	6	2	2	2				1	
9	2	6	2	2	2				1	
10	2	6	2	2	2				1	
11	2	6	2	2	2				1	
12	2	6				2	2	2		1
13	2	6				2	2	2		1
14	2	6				2	2	2		1
15	3	6	2	2	2				1	
16	3	6	2	2	2				1	
17	3	6	2	2	2				1	
18	3	6	2	2	2				1	
19	3	6	2	2	2				1	
20	3	6				2	2	2		1
21	3	6				2	2	2		1
22	4	6	2	2	2				1	
23	4	6	2	2	2				1	
24	4	6	2	2	2				1	
25	4	6	2	2	2				1	
26	4	6				2	2	2		1
27	4	6				2	2	2		1
28	4	6				2	2	2		1
29	5	6	2	2	2				1	
30	5	6	2	2	2				1	
31	5	6	2	2	2				1	
32	5	6	2	2	2				1	
33	5	6	2	2	2				1	
34	5	6				2	2	2		1
35	5	6				2	2	2		1
TOTAL		210	46	46	46	24	24	24	23	12

ATTACHMENT 1b
SIMULTANEOUS AIRCRAFT vs PLATE TESTS AT YYT
 NATURAL FREEZING RAIN CONDITIONS

RUN #	OCCASION #	NUMBER OF PLATES TESTED	PLATES						WING	
			XL54 FROM TRUCK/PAIL	XL54 FROM CONT PRIOR	DIL XL54 FROM CONT PRIOR	ULTRA FROM TRUCK/PAIL	ULTRA FROM CONT PRIOR	ULTRA FROM CONT AFTER	XL54 FROM TRUCK	ULTRA FROM TRUCK
1	1	6	2	2	2				1	
2	1	6	2	2	2				1	
3	1	6	2	2	2				1	
4	1	6	2	2	2				1	
5	1	6	2	2	2				1	
6	1	6	2	2	2				1	
7	2	6	2	2	2				1	
8	2	6	2	2	2				1	
9	2	6	2	2	2				1	
10	2	6	2	2	2				1	
11	2	6	2	2	2				1	
12	2	6	2	2	2				1	
13	3	6	2	2	2				1	
14	3	6	2	2	2				1	
15	3	6	2	2	2				1	
16	3	6	2	2	2				1	
17	3	6	2	2	2				1	
18	3	6	2	2	2				1	
19	4	6	2	2	2				1	
20	4	6	2	2	2				1	
21	4	6	2	2	2				1	
22	4	6	2	2	2				1	
23	4	6	2	2	2				1	
24	4	6	2	2	2				1	
25	5	6	2	2	2				1	
26	5	6	2	2	2				1	
27	5	6	2	2	2				1	
28	5	6	2	2	2				1	
29	5	6	2	2	2				1	
30	5	6	2	2	2				1	
TOTAL		180	60	60	60	0	0	0	30	0

ATTACHMENT II
SIMULTANEOUS AIRCRAFT vs PLATE TESTS
 TEST EQUIPMENT CHECKLIST

TASK	Montreal		Toronto		St. John's	
	Resp.	Status	Resp.	Status	Resp.	Status
Logistics (on E/W) (1)						
Call Escort Service						
Rent Van						
Call Personnel						
Advise Airlines (Personnel, A/C Orientation, Equip)						
Monitor Forecast						
Get Motorhome/Trailer						
Rent Generator						
Arrange for Communication						
Test Equipment						
Stands X 2						
C/FIMS Equipment						
Meteorological equipment (wind vane/anemometer)						
Tape Recorder with Mic.(voice)						
Weigh Scale						
Video Cameras X 3						
Thickness Gauge - optional						
Reg. Plates (wing nuts) X 12						
Data Forms for plates, wings and general						
Aircraft Wing Forms						
Isopropyl alcohol						
XL 54 Fluid for plates						
Ultra Fluid for plates						
Plate Pan X 4						
Compass						
Tape measure						
Clipboards X 4						
Space pens X 4						
Paper Towels						
Rubber squeegees						
Plastic Refills for Fluids and funnels						
Electrical Extension Cords						
Lighting						
Tools						
Water for dilution						
Stop watches						
Pylons or suction cup						
RVSI Equipment						
Storage bins for small equipment						
Cellular Telephone						
Temperature Probe x 2						
Thermometer (glass)						
Pail of Ice (to calibrate temp. probe)						
Q Beams						
Pails for Fluid from Truck						
Protective clothing						
Refractometer						
Tie wraps						
Tags (Labels) for Fluid designation on stand						
Scrapers						
Whistle						
First Aid Kit						
OTHER TEST EQUIPMENT (1)						
XL 54 Fluids for wings (UCAR)						
Ultra Fluids for wings (UCAR)						
Spray vehicle for XL54 x1 (A/L)						
Spray vehicle for Ultra x1 (A/L)						
Test Aircraft (heated, wing lights) (A/L)						
Visual Inspection Equip. - lift/scaffold or step ladder (A/L)*						
Storage Facilities (A/L)						
Fluid Collection Facilities (A/L)						
Electrical Power (A/L)						
Airline Personnel						

(1) To be provided by others

* If two testers (1 video and 1 observer) can get onto the cab of each cherry picker, then lifts or scaffold would not be required.

The cab of the cherry picker, where the observers and videographers are located, needs to be mobile in order to capture the close-in details of the failure progression.

ATTACHMENT III
Simultaneous Aircraft vs Plate Tests
Responsibilities/Duties of Test Personnel

Refer to Figure 1 for position of equipment and personnel relative to the aircraft. Also refer to the test procedure (Attachment IV) for more detailed requirements for the testers.

- Video 1 (V1)
- Video a/c test site
 - Concentrate on test stands A & B - plate failures
 - Must be mobile
 - Picture to be steady and well lit
 - Knowledge of test procedures and conditions
 - Located on ground
- Video 2 (V2)
- Good knowledge of test procedures
 - Must accurately call end conditions
 - To video wing after fluid application to concentrate on fluid contamination and failure
 - Need high quality photo steady and well lit
 - To be located in "cherry picker" side A, then side B after failure of side A wing
 - Will relay notes and observations to tester T2/T4 taking notes
- Tester 1 (T1)
- Located in a/c cabin
 - To observe and note contamination and failure of fluid through a/c windows
 - Able to video observations through windows
 - Concentrate on wing critical areas to be determined by test staff
 - Knowledge of video camera and test procedures and conditions
 - Pilot or co-pilot experience
- Tester 2 (T2)
- Located on ground (ladder) or in cherry picker
 - To aid V2 and T4 and T3
 - Take notes dictated by V2 and/or T4
 - Make observations of wing A and/or B
 - Knowledgeable in procedures and conditions
 - Mobile between V2 and T4

ATTACHMENT III - RESPONSIBILITIES/DUTIES

- Tester 3 (T3)
- Apply fluids to Stand A
 - Located by Test Stand A
 - Make observations and call conditions on test stand A - take notes
 - Knowledge of procedures for test stands
 - To aid T5 on stand B, if needed
- Tester 4 (T4)
- Located in cherry picker B or on scaffold (ladder)
 - To observe application of fluid to wing B
 - Take notes
 - Knowledgeable in test procedures and conditions
 - Call conditions e.g. failures
 - Communicate with T2
- Tester 5 (T5)
- located on ground by test stand B
 - Apply fluid to test stand B
 - Observe and note conditions
 - Call failures
 - Knowledgeable of test procedures and conditions
- Tester 6 (T6)
- Team Leader
 - Knowledge of test procedures and conditions
 - Responsible for area and people
 - To aid any personnel on side A or B
 - Coordinate actions of APS team and Air Canada personnel
 - Responsible for weather condition observations, forecast and recording
 - Ensure that the end conditions on the plates and on the aircraft are called in the same manner.
 - Ensure that there are no objects on the ground which may cause FOD at end of session.
- Tester 7 (T7)
- Familiar with test procedures.
 - Mobile.
 - To gather wing skin temperature data during fluid testing.
 - Responsible for accurate collection and recording of data.
 - Will report to T6.
 - Take care to avoid excessive disturbance of fluid on wing.

FIGURE 1
POSITION OF EQUIPMENT AND PERSONNEL

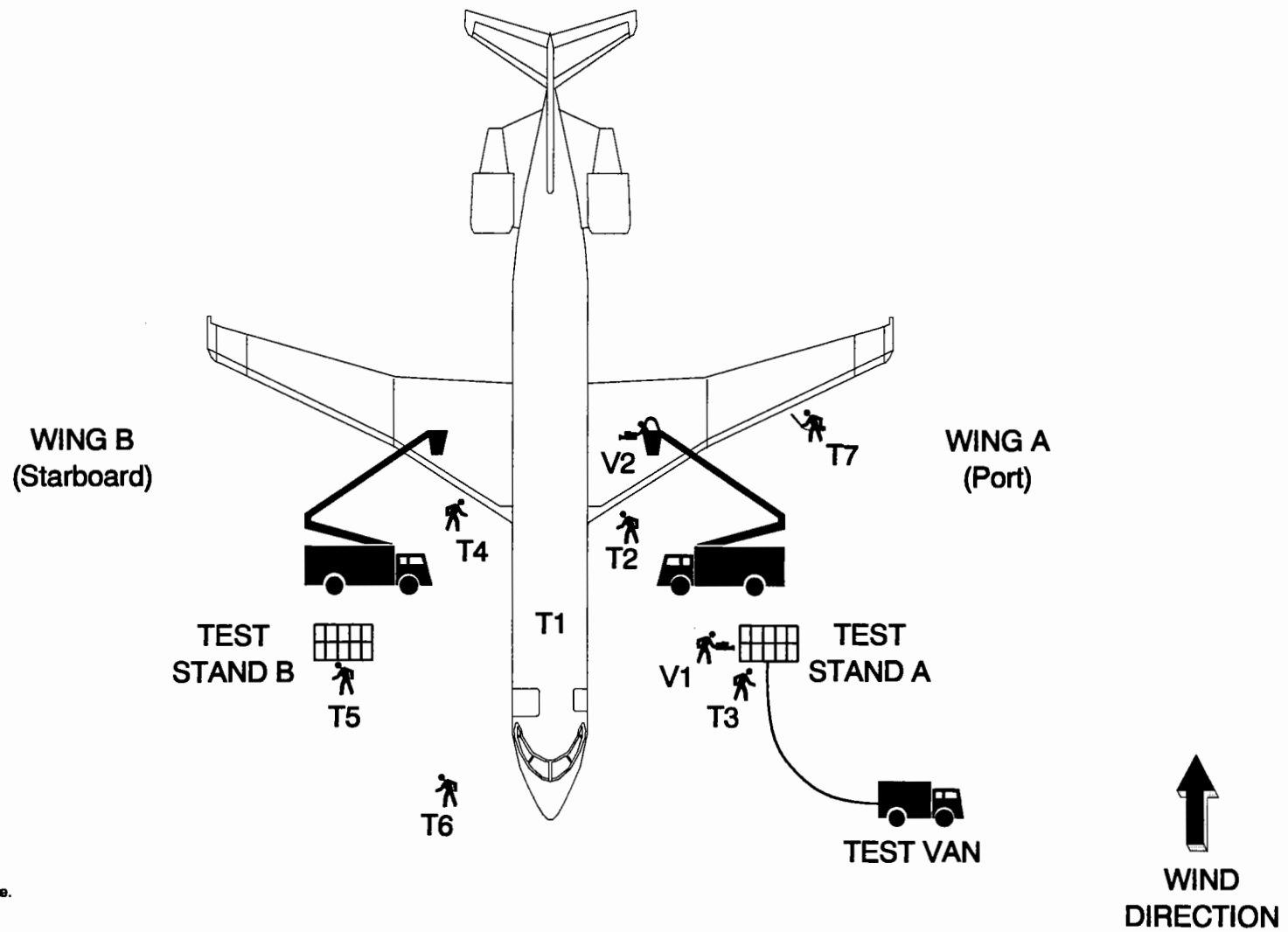

Note: These positions are approximate.
The actual positions will be
dependent upon the site.

ATTACHMENT IV
TEST PROCEDURE

1. **Training**

Training for this experiment will consist of a dry-run in which team members are assembled and duties are assigned to each member. This will allow the team to conduct an experiment in which team members will coordinate their activities to prepare for a systematic and comprehensive execution of a given experimental run and try to determine the logistics of an actual experiment. This procedure will inevitably be streamlined during field testing. All team members should be familiar with salient aspects of flat-plate testing. They should possess the ability to identify fluid failures, and call end conditions.

2. **Pre-Test Set-Up**

Figure 1 should be consulted in reference to the responsibilities.

1. Arrange favourable aircraft orientation (**leading edge into the wind**) and place pylons below wings to delineate sections (T6).
2. Set up test stands as per *flat plate test procedure (FPTP)* orient standard wind (T3/T5).
3. Set up power cords and generator (optional) (T3/T5).
4. Ensure aircraft APU or GPU are functioning; Turn on aircraft wing lights (optional) (T6/T1).
5. Ensure weather instrumentation is functional (T6).
6. Position flat plate test stand into the wind as per the *FPTP*. Note that this orientation may be different than that of the aircraft (T3/T5).
7. Position pre-filled test fluid containers, squeegees, and scrapers accordingly. (Type I fluids are stored inside at 20°C; Type II fluids are applied at ambient temperature) (T3/T5).
8. Check cameras and recording devices for proper function (V1/V2).
9. Ensure proper illumination of test areas (T3/T5/V1/V2).
10. Establish communication between team members and coordinator (T6).
11. Camera and test personnel ensure ability to identify laser light signature (T2/T3/V1/V2).

12. Synchronize all timepieces including video cameras to the instrument computer (T6).
13. Ensure airline personnel are aware and knowledgeable of test procedures (T6).
14. Data forms to be used are: general data form (Figure 3) by the test site leader (T6); standard plate data form from the *FPTP* by T3 or T5; and the aircraft data form by T1 and T2 or T4.

3. Initialization and Execution of Fluid Test

1. Ensure all aircraft de/anti-icing systems are off (T1).
2. Measure and record fuel load in wing to be tested (T1/T6).
3. Measure wing skin temperature at predetermined locations before fluid application (see Figure 3a) (T7).
4. Record all necessary data from fluid delivery vehicle (cherry picker). (Temperature, nozzle-type, quantity of fluid, dilution of fluid, etc.) (T6).
5. Record all general measurements and general information in the three data forms (T6). Attach clips with fluid name and type to stand (T3/T5).
6. Ensure all fluids are diluted to the appropriate concentrations (T3/T5).
7. **Type I Fluid Application** (T3/T5) - the following subsection of the procedure refers to Figure 2a
 - 7.1 Spray fluid from cherry picker into pail.
 - 7.2 Apply fluid onto test plates U and X from pail. This signals **RELATIVE time = 0. (Start the stop watch and record true time for the beginning of the test)**. A whistle is suggested to designate this event.
 - 7.3 Intentionnaly left blank.
 - 7.4 Cherry Picker vehicle proceeds to apply heated fluid to wing surface.
 - 7.5 Gasoline container application of de-icing fluid to plates V and Y (synchronized to step 7.4). (**Proceed directly to 7.6.**)
 - 7.6 Repeat step 7.5 onto plates W and Z with *diluted* de-icing agent.
8. **Type II Fluid Application** (T3/T5) - the following subsection refers to Figure 2b
 - 8.1 Procedures 7.1 to 7.4 are repeated
 - 8.2 Apply Ultra Type II onto plates U and X from the pail after sprayed into pail from cherry picker. (**Start the stop watch and record true time for the beginning of the test**). A whistle is suggested to designate this event.
 - 8.3 Apply Type II fluid onto the wing.
 - 8.4 Type II fluid is applied manually to plates V and Y as wing application commences.
 - 8.5 Type II fluid is applied manually to plates W and Z as wing application is completed.

9. Put two plate pans on test stand and note time and initial weights (refer to *FPTP*) (T3/T5).
10. Continue Holdover Time Testing until the end conditions are called for all six flat plates. (See Section 6. below).
11. Final wing skin temperature measurements are taken to conclude the test (T7).
12. Final plate pan measurements are taken (T3/T5).

4. **Holdover Time (end condition) Testing**

Holdover time testing will consist of: A) Video recording of all procedures and fluid failures; and B) Visual monitoring and manual recording of failure data.

A. **Video Recording** (V1, V2 and T1)

Camera recordings are to be systematic so that subsequent viewing of documented tests allow for the visual identification of failing sections of the wing surface with respect to the aircraft itself.

1. Record the complete fluid application from a distance.
2. Record the conditions of the flat plate set-up and the wing at time = 0.
3. (i) For Type I fluids, record conditions of wing and flat plates every 2 minutes.
(ii) For Type II fluids, record conditions of wing and test plates every 5 minutes.
4. Once the first failure on the wing or on the one inch line is called, monitor (record) continuously until the end of the test.
5. Record the "important events" as described in the form (Figure 4)
6. Record condition of the wing and representative surface continuously from the aircraft cabin.

B. **Visual Recording**

1. For the plates, refer to *FPTP* for determination of the end condition (T3/T5).
2. For the wing, three (3) ways to record visual observations have been devised (T2/T4).
 - (i) Manual recording of failure contours on preprinted data form (Figure 4). This is to be performed by person making the observations, and/or
 - (ii) Observer may talk to a voice recorder, and/or
 - (iii) Observer may talk directly to the video camera microphone.

ATTACHMENT IV - TEST PROCEDURE

In any case, the methods would utilize the Wing Section Data Form (Figure 4), and these are complementary to the video recording.

3. From the cockpit and the cabin, pilot must observe and note the progression of fluid failure on the wing using the data form provided for the pilot (Figure 4). Special care must be given to observation of the representative surface (T1).
4. When the first flat plate failure is reported at the six-inch line ($\frac{1}{3}$ of crosshairs), the visual data recorder (T2/T4) must acquire contours every 2 to 5 minutes, thereafter. Time increment is dependent upon weather. Process is continued until all six flat plates have failed according to the end condition defined in the *FPTP* (T2/T4).
5. If wing fails before first flat plate fails, continue data collection for wing via contour drawing and/or voice communication until all flat plates fail (T2/T4).
6. Team coordinator (T6) must confirm initial end condition calls on flat plate tests. Once the first flat plate fails at the six inch line ($\frac{1}{3}$ of crosshairs), the coordinator is notified and makes inspection of the wing contour drawing to confirm the accuracy of the wing data and instructs video camera operator to make a record of the area. The area should be located using a laser pointer. If the wing start to fail first, the coordinator must confirm this and simultaneously note areas of failure on the flat plates using the laser pointer.
7. Measure as many wing skin temperatures as is possible (see Figure 3a for recommended frequency). Care should be taken not to disturb the fluid on the wing. A bucket of ice should be available to ensure that the instrument is properly calibrated and the temperature should also be verified against the plate temperature provided by the C/FIMS (T7).

5. End condition

Refer to the *FPTP* for this definition.

6. End of test

Team coordinator (T6) must confirm the end of test. This occurs when all six plates have reached the end condition (under heavy snow conditions, continue testing until nine crosshairs have failed) and when a substantial part of the aircraft wings leading/trailing edge has reached the end condition. Most or all of the "important events" in the aircraft wing data from (Figure 4) must be completed by T1 and T2/T4. Ensure all data collection is completed including final skin temperatures (T7) and plate pan measurements (T3/T5).

FIGURE 2a
TYPE I FLUID APPLICATION

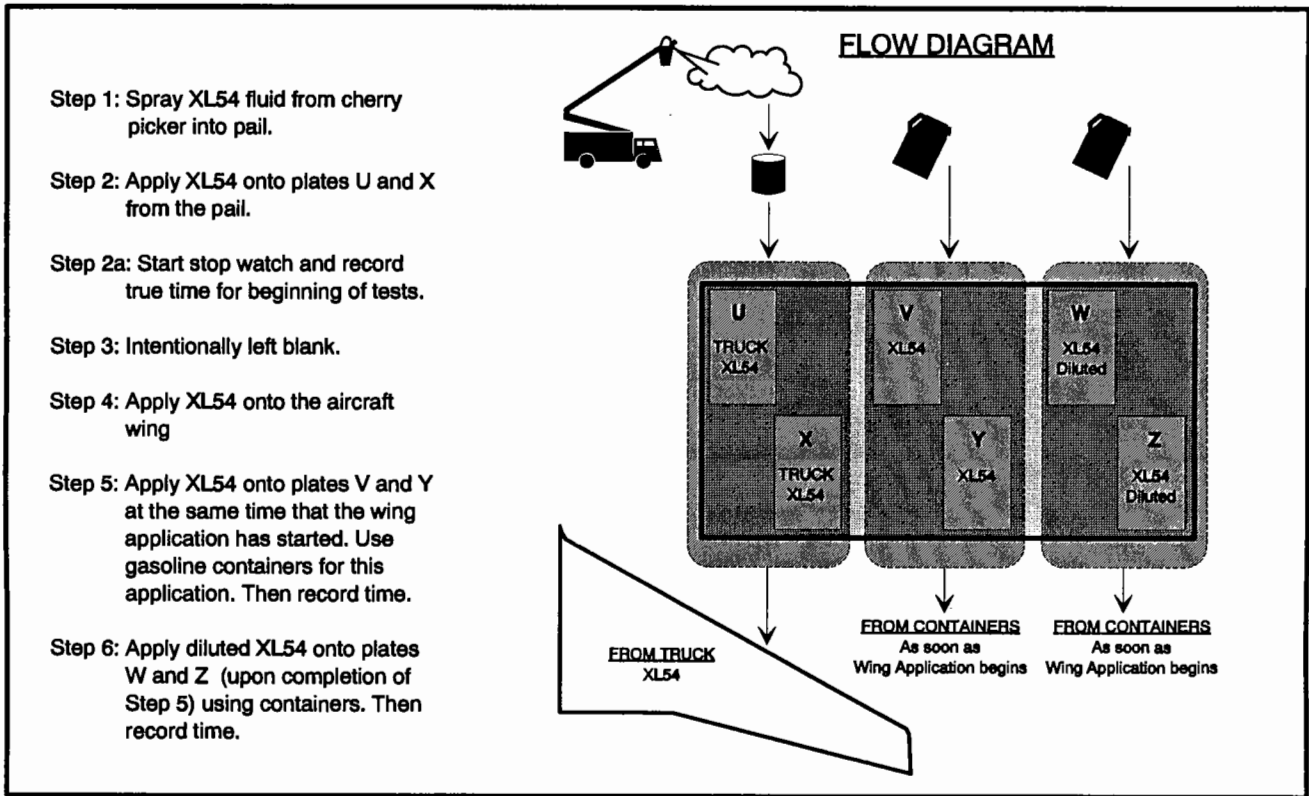
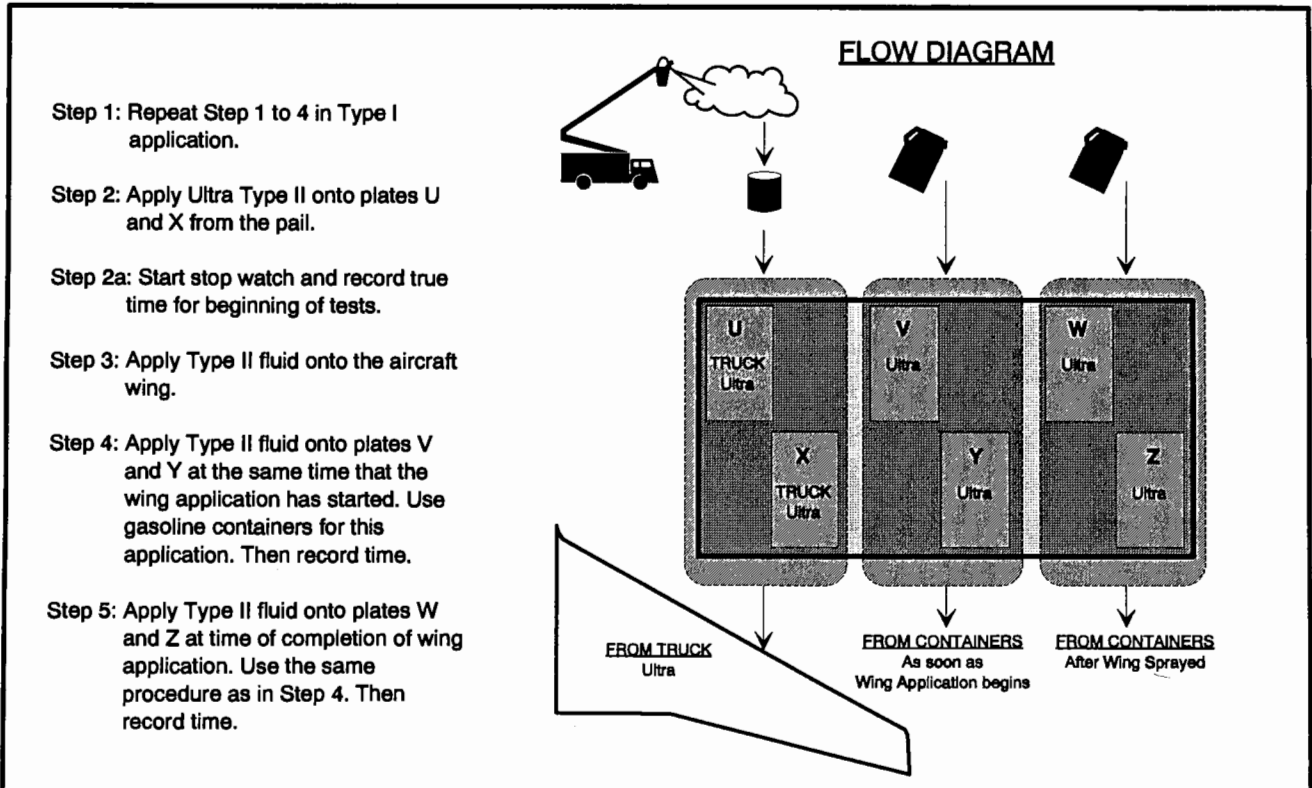

FIGURE 2b
TYPE II FLUID APPLICATION



BM2880DRAWFLD_APPL.DRW

TABLE 5.2

PERCENTAGE OF GLYCOL MIXTURE WITH WATER (%) AS A FUNCTION OF OAT USED FOR DILUTED TYPE I TESTS TO ACHIEVE A 10°C BUFFER

Outside Air Test Temperature (°C)	Fluid Freeze Point (°C)	B-250* (Dilution)	B-251* (Dilution)	B252* (Dilution)	B-253*	
					(Dilution)	(Brix)
0 °C	-10 °C	28%	28%	31%	23%	14
-2 °C	-12 °C	31%	31%	35%	26%	16
-4 °C	-14 °C	35%	34%	39%	29%	18
-6 °C	-16 °C	37%	37%	42%	31%	19.7
-8 °C	-18 °C	40%	40%	45%	34%	21.2
-10 °C	-20 °C	42%	42%	48%	36%	22.5
-14 °C	-24 °C			50%**		24.8
-15 °C	-25 °C	47%	48%	53%	41%	25.5
-20 °C	-30 °C	52%	52%	58%	46%	27.9
-25 °C	-35 °C	56%	57%	63%	50%	30
-30 °C	-40 °C	60%	TBD	67%	54%	32
-33 °C	-43 °C		TBD		57%**	33
-35 °C	-45 °C	63%**	63%**			33.7

* Based on a 10°C buffer. † Based on a 10°C buffer. If verifying the glycol concentration/freeze point with a refractometer, note that the freeze point will be 10°C lower.

** Standard Type I mixtures

A-15

**FIGURE 3
GENERAL FORM**

AIRPORT: YUL YYZ YYT
 EXACT LOCATION OF TEST: _____
 DATE: _____
 RUN #: _____
 LOCATION OF PILOT IN CABIN: _____

AIRCRAFT TYPE: A320 DC-9 B-737 RJ BAe 146
 AIRLINE: _____
 FIN #: _____
 FUEL LOAD: _____ LB / KG

1st FLUID APPLICATION

Actual Start Time: _____ am / pm Actual End Time: _____ am / pm
 Start of Fluid Gauge: _____ L / gal End of Fluid Gauge: _____ L / gal
 Type of Fluid: _____ Truck #: _____
 Fluid Temperature: _____ Fluid Nozzle Type: _____

2nd FLUID APPLICATION

Actual Start Time: _____ am / pm Actual End Time: _____ am / pm
 Start of Fluid Gauge: _____ L / gal End of Fluid Gauge: _____ L / gal
 Type of Fluid: _____ Truck #: _____
 Fluid Temperature: _____ Fluid Nozzle Type: _____

Time When Stop Watch is Started: _____ am/pm
 End of Test Time: _____ am/pm

TEMPERATURE MEASUREMENTS

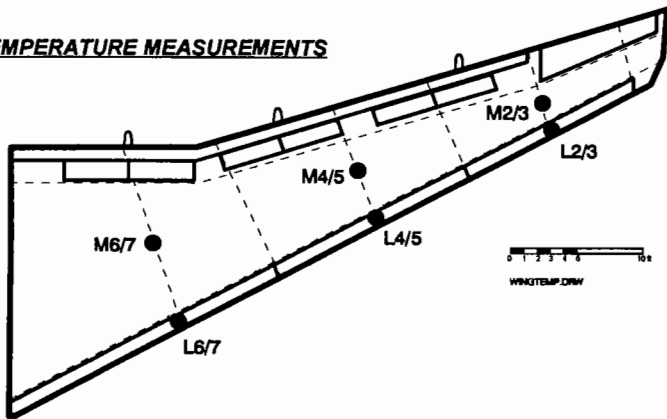

COMMENTS: _____

ENTER FLUID TYPE:						
TIME (min)	TEMPERATURE AT LOCATION (°C)					
	L6/7	M6/7	L4/5	M4/5	L2/3	M2/3
Before ¹ ()						
* ()						
3						
6						
10						
15						
20						
25						
30						
45						
60						
90						
End ()						

(1) Actual Time Before Fluid Application
 *Time After Fluid Application.

MEASUREMENTS BY: _____

HAND WRITTEN BY: _____

REMEMBER TO SYNCHRONIZE TIME

DE/ANTI-ICING FORM FOR AIRCRAFT WING

VERSION 2.3

Winter 94/95

LOCATION:	DATE:	RUN NUMBER:	WING #:	RVSI AVAILABLE: Y / N
Time After Fluid Applied to Plates U and X:	am / pm			C/FIMS SENSOR AVAILABLE: Y / N

TIME OF INITIAL FLUID APPLICATION: _____ (min)
(Last step only)

TIME AFTER FLUID APPLICATION: _____ (min)
(Last step only)

DIRECTION OF AIRCRAFT: _____

FAILURES CALLED BY: _____

DESCRIBE SENSORS/LOCATION: _____

HANDWRITTEN BY: _____

COMMENTS: _____

ASSISTED BY: _____

IMPORTANT EVENTS (min)				
	L.Edge	Mid	T.Edge	Rep. Surface
1st Failure:	_____	_____	_____	_____
10% :	_____	_____	_____	_____
25% :	_____	_____	_____	_____
50% :	_____	_____	_____	_____
75% :	_____	_____	_____	_____
100% :	_____	_____	_____	_____

DRAW FAILURE CONTOURS ACCORDING TO THE PROCEDURE
(Indicate Representative Surface on Drawing)

File: Aform2-3.drw

DC-9 Series 30

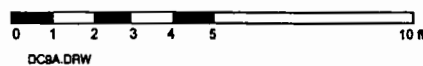
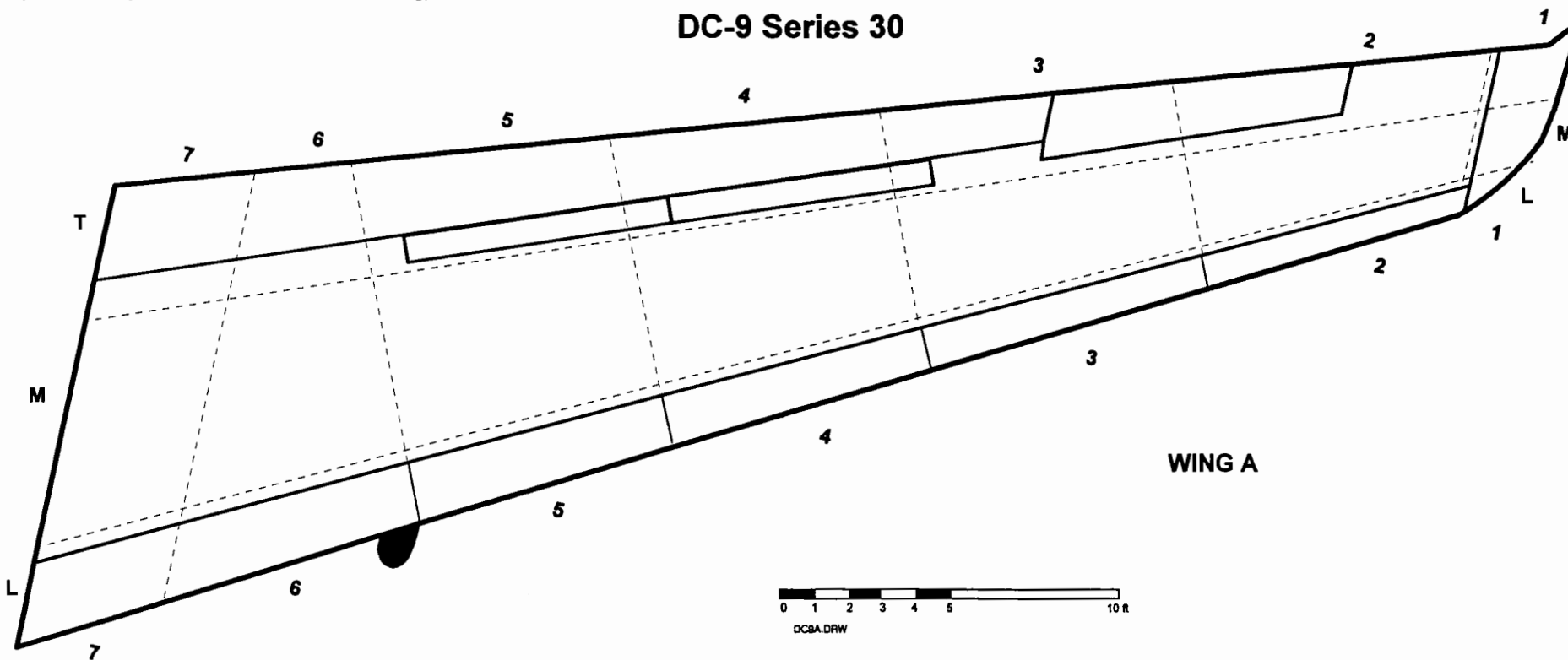

DC9A.DRW

Note: To Compare to Flat Plate testing, subtract "Time of Initial Fluid Application".

FIGURE 4

DE/ANTI-ICING FORM FOR AIRCRAFT WING

VERSION 2.3

Winter 94/95

REMEMBER TO SYNCHRONIZE TIME

LOCATION: _____	DATE: _____	RUN NUMBER: _____	WING #: _____	RVSI AVAILABLE: Y / N
Time After Fluid Applied to Plates U and X: _____	am / pm			C/FIMS SENSOR AVAILABLE: Y / N

TIME OF INITIAL FLUID APPLICATION: _____ (min)
(Last step only)

TIME AFTER FLUID APPLICATION: _____ (min)
(Last step only)

DIRECTION OF AIRCRAFT: _____

FAILURES CALLED BY: _____

DESCRIBE SENSORS/LOCATION: _____

HANDWRITTEN BY: _____

COMMENTS: _____

ASSISTED BY: _____

IMPORTANT EVENTS (min)				
	L.Edge	Mid	T.Edge	Rep. Surface
1st Failure:	_____	_____	_____	_____
10% :	_____	_____	_____	_____
25% :	_____	_____	_____	_____
50% :	_____	_____	_____	_____
75% :	_____	_____	_____	_____
100% :	_____	_____	_____	_____

DRAW FAILURE CONTOURS ACCORDING TO THE PROCEDURE
(Indicate Representative Surface on Drawing)

DC-9 Series 30

File: Aform2-3.drw

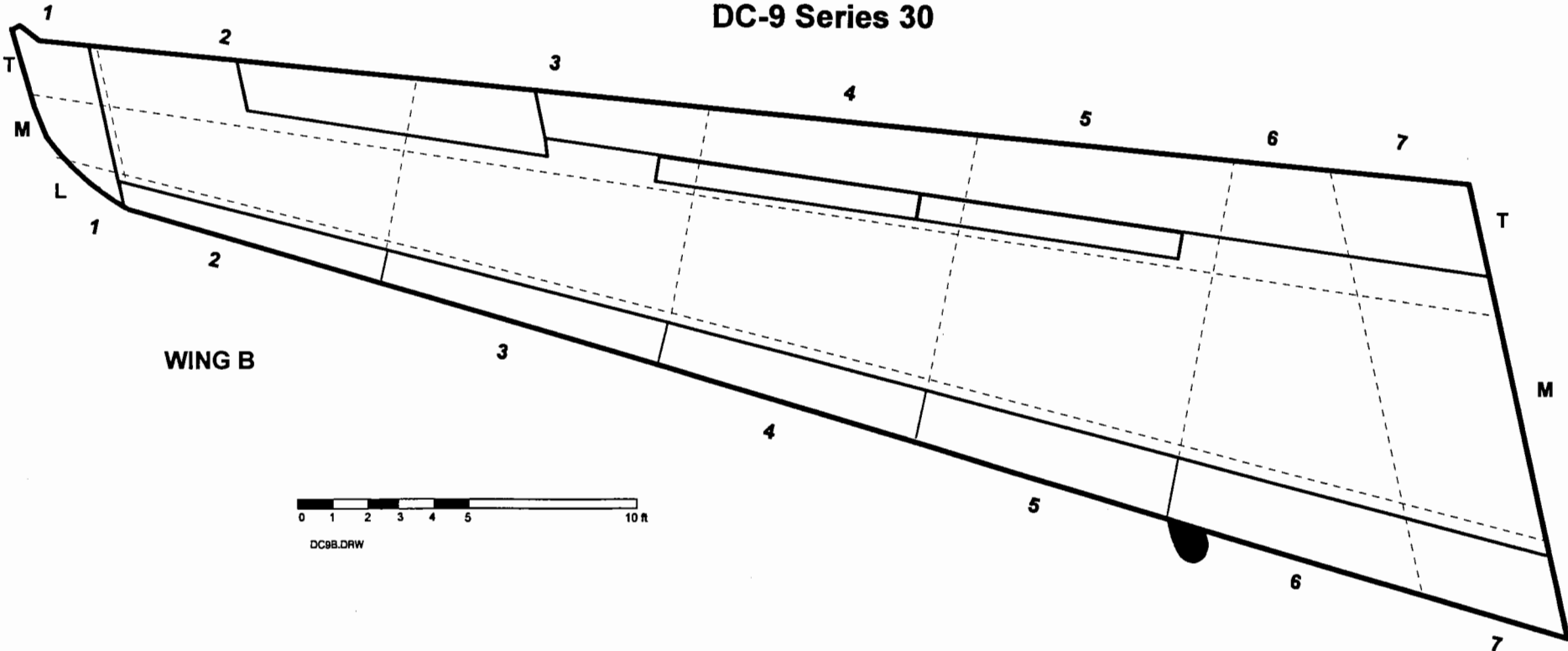

FIGURE 4

Note: To Compare to Flat Plate testing, subtract "Time of Initial Fluid Application".

File: V2-3_DC9.XLS Printed: 4/12/95

FIGURE 4

DE/ANTI-ICING FORM FOR AIRCRAFT WING

REMEMBER TO SYNCHRONIZE TIME

VERSION 2.2

Winter 94/95

LOCATION: _____	DATE: _____	RUN NUMBER: _____	WING #: _____	RVSI AVAILABLE: Y / N
Time After Fluid Applied to Plates U and X: _____ am / pm				C/FIMS SENSOR AVAILABLE: Y / N

TIME OF INITIAL FLUID APPLICATION: _____ (min)
(Last step only)

TIME AFTER FLUID APPLICATION: _____ (min)
(Last step only)

DIRECTION OF AIRCRAFT: _____

FAILURES CALLED BY: _____

DESCRIBE SENSORS/LOCATION: _____

HANDWRITTEN BY: _____

COMMENTS: _____

ASSISTED BY: _____

IMPORTANT EVENTS

TIME (min)	LOCATION
1st Failure: _____	_____
10% of LE/TE: _____	_____
25% of LE/TE: _____	_____
50% of LE/TE: _____	_____
75% of LE/TE: _____	_____
100% of LE/TE: _____	_____
1st Failure on Representative Surface: _____	_____
10% of Representative Surface: _____	_____
50% of Representative Surface: _____	_____
100% of Representative Surface: _____	_____

DRAW FAILURE CONTOURS ACCORDING TO THE PROCEDURE
(Indicate Representative Surface on Drawing)

A320

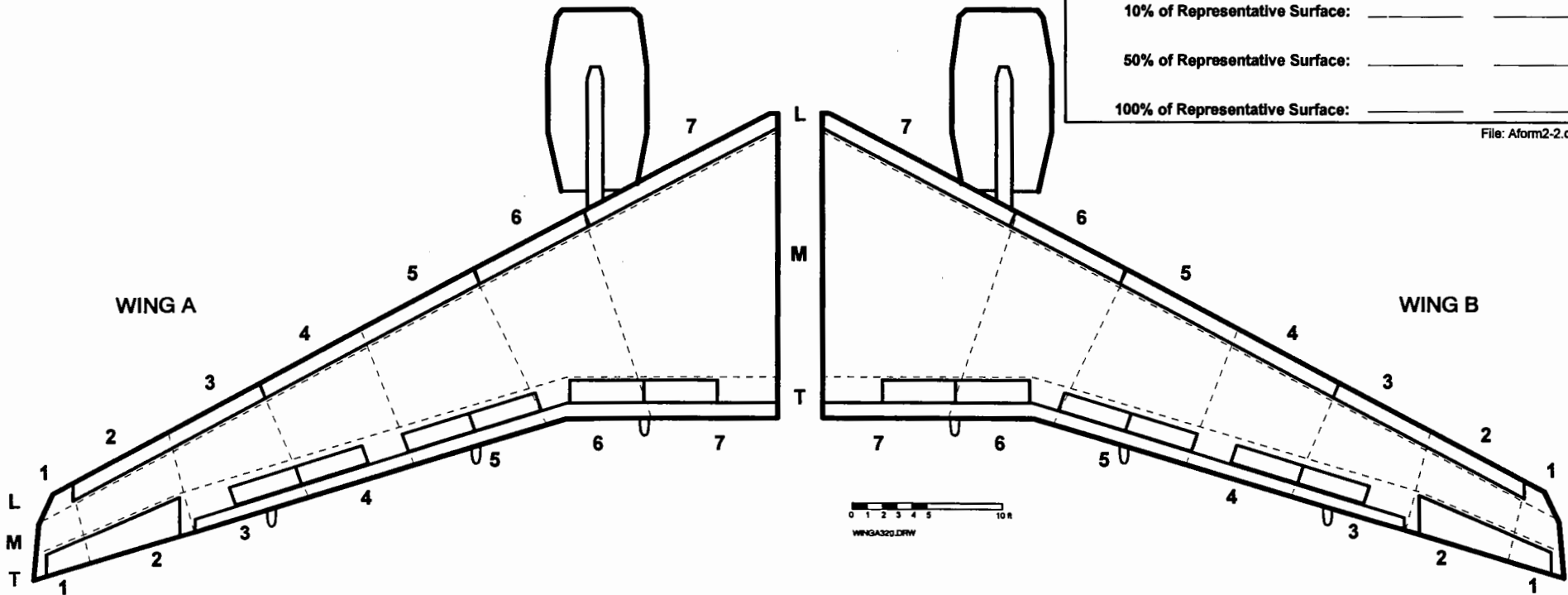

File: Aform2-2.drw

Note: To Compare to Flat Plate testing, subtract "Time of Initial Fluid Application".

File: FORMA320.XLS Printed: 1/30/95

61-19

FIGURE 4

DE/ANTI-ICING FORM FOR AIRCRAFT WING

REMEMBER TO SYNCHRONIZE TIME

VERSION 2.3

Winter 94/95

LOCATION: Time After Fluid Applied to Plates U and X:	DATE: am / pm	RUN NUMBER:	WING # :	RVSI AVAILABLE: Y / N C/FIMS SENSOR AVAILABLE: Y / N
---	-------------------------	--------------------	-----------------	---

TIME OF INITIAL FLUID APPLICATION: _____ (min) (Last step only)	TIME AFTER FLUID APPLICATION: _____ (min) (Last step only)	FAILURES CALLED BY: _____
DIRECTION OF AIRCRAFT: _____	COMMENTS: _____	HANDWRITTEN BY: _____
DESCRIBE SENSORS/LOCATION: _____	_____	ASSISTED BY: _____

DRAW FAILURE CONTOURS ACCORDING TO THE PROCEDURE
(Indicate Representative Surface on Drawing)

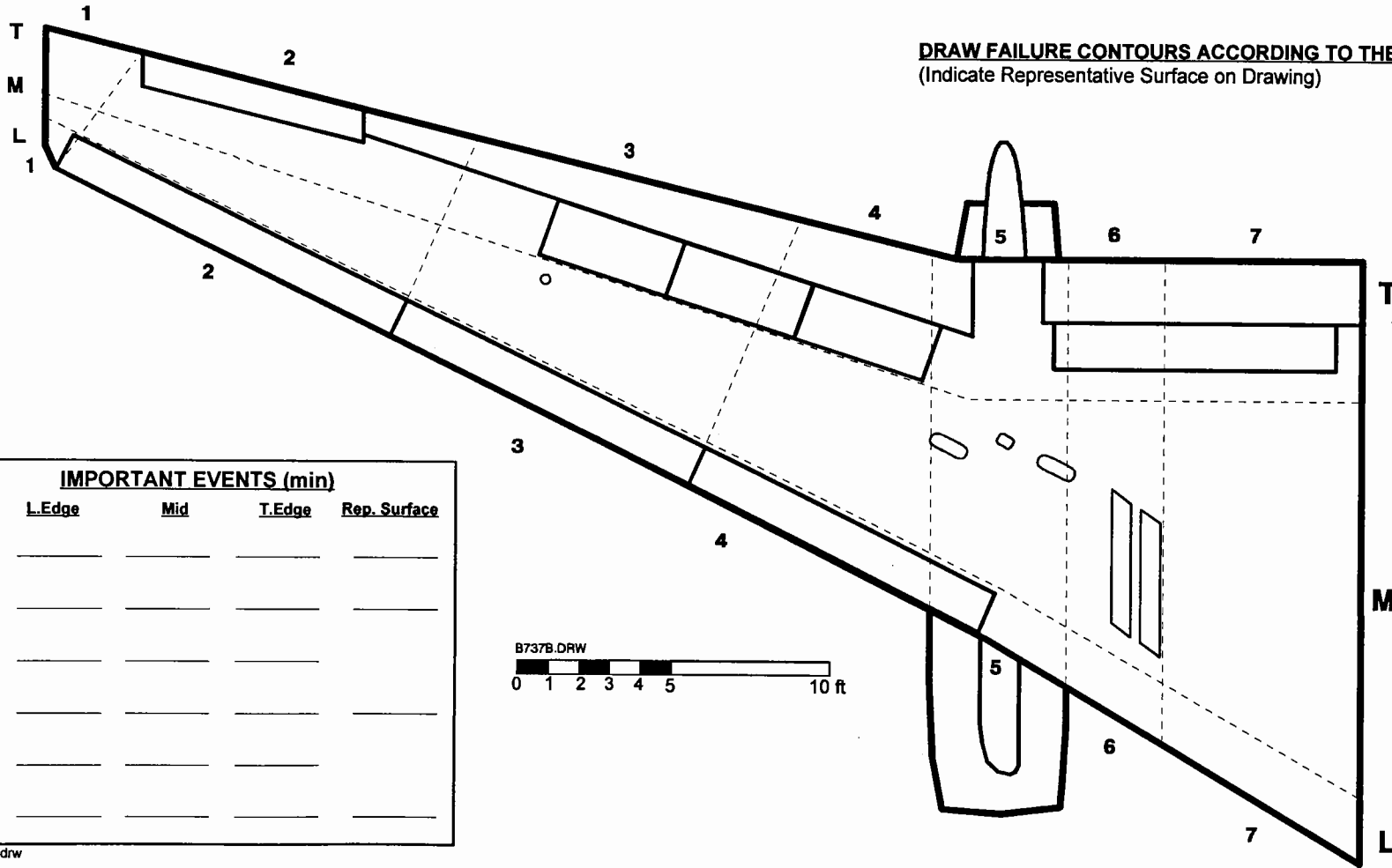

IMPORTANT EVENTS (min)

	<u>L.Edge</u>	<u>Mid</u>	<u>T.Edge</u>	<u>Rep. Surface</u>
1st Failure:	_____	_____	_____	_____
10% :	_____	_____	_____	_____
25% :	_____	_____	_____	_____
50% :	_____	_____	_____	_____
75% :	_____	_____	_____	_____
100% :	_____	_____	_____	_____

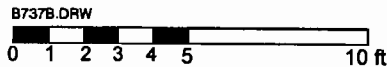

File: Afrm2_3B.drw

Note: To Compare to Flat Plate testing, subtract "Time of Initial Fluid Application".

FIGURE 4

DE/ANTI-ICING FORM FOR AIRCRAFT WING

REMEMBER TO SYNCHRONIZE TIME

VERSION 2.3

Winter 94/95

LOCATION:	DATE:	RUN NUMBER:	WING #:	RVSI AVAILABLE: Y / N
Time After Fluid Applied to Plates U and X:	am / pm			C/FIMS SENSOR AVAILABLE: Y / N

TIME OF INITIAL FLUID APPLICATION: _____ (min) (Last step only)	TIME AFTER FLUID APPLICATION: _____ (min) (Last step only)	FAILURES CALLED BY: _____
DIRECTION OF AIRCRAFT: _____	COMMENTS: _____	HANDWRITTEN BY: _____
DESCRIBE SENSORS/LOCATION: _____		ASSISTED BY: _____

DRAW FAILURE CONTOURS ACCORDING TO THE PROCEDURE
(Indicate Representative Surface on Drawing)

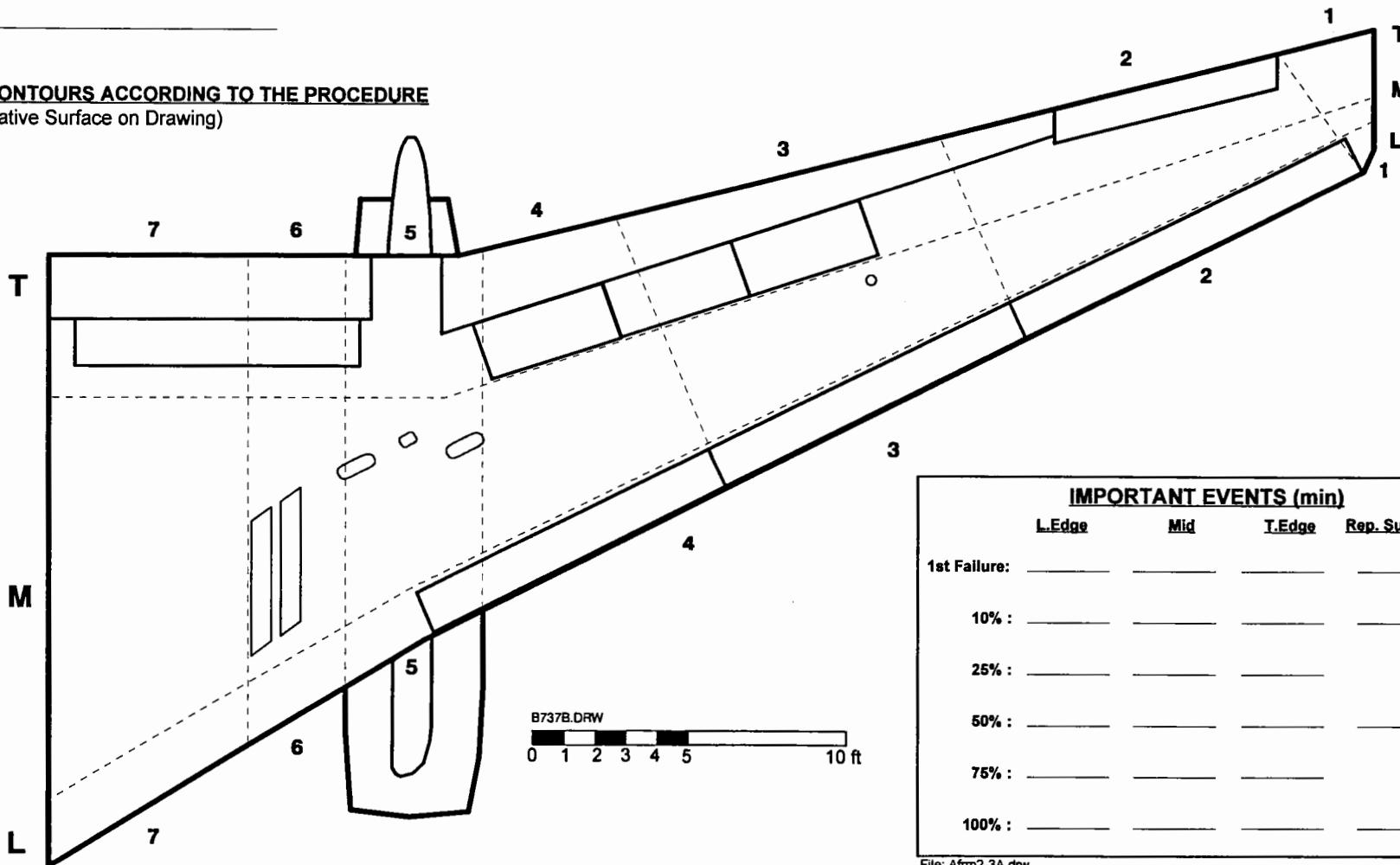

IMPORTANT EVENTS (min)				
	L.Edge	Mid	T.Edge	Rep. Surface
1st Failure:	_____	_____	_____	_____
10% :	_____	_____	_____	_____
25% :	_____	_____	_____	_____
50% :	_____	_____	_____	_____
75% :	_____	_____	_____	_____
100% :	_____	_____	_____	_____

File: Afrm2-3A.drw

Note: To Compare to Flat Plate testing, subtract "Time of Initial Fluid Application".

File: V2-3_737.XLS Printed: 4/12/95

A-21

FIGURE 4

DE/ANTI-ICING FORM FOR AIRCRAFT WING

REMEMBER TO SYNCHRONIZE TIME

VERSION 2.2

Winter 94/95

LOCATION: _____	DATE: _____	RUN NUMBER: _____	WING #: _____	RVSI AVAILABLE: Y / N
Time After Fluid Applied to Plates U and X: _____	am / pm			C/FIMS SENSOR AVAILABLE: Y / N

TIME OF INITIAL FLUID APPLICATION: _____ (min)
(Last step only)

TIME AFTER FLUID APPLICATION: _____ (min)
(Last step only)

DIRECTION OF AIRCRAFT: _____

FAILURES CALLED BY: _____

DESCRIBE SENSORS/LOCATION: _____

HANDWRITTEN BY: _____

COMMENTS: _____

ASSISTED BY: _____

IMPORTANT EVENTS

TIME (min)	LOCATION
1st Failure: _____	_____
10% of LE/TE: _____	_____
25% of LE/TE: _____	_____
50% of LE/TE: _____	_____
75% of LE/TE: _____	_____
100% of LE/TE: _____	_____
1st Failure on Representative Surface: _____	_____
10% of Representative Surface: _____	_____
50% of Representative Surface: _____	_____
100% of Representative Surface: _____	_____

File: Aform2-2.drw

DRAW FAILURE CONTOURS ACCORDING TO THE PROCEDURE

(Indicate Representative Surface on Drawing)

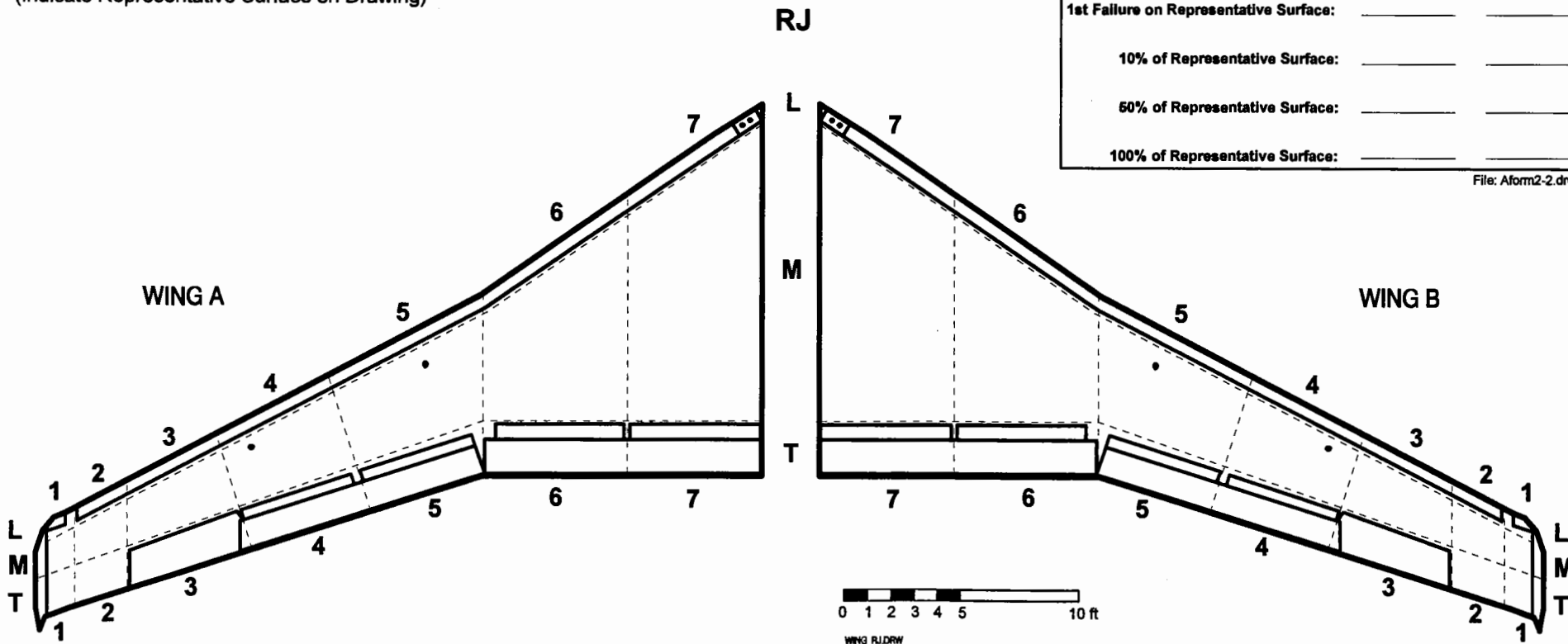

Note: To Compare to Flat Plate testing, subtract "Time of Initial Fluid Application".

File: FORM_RJ.XLS Printed: 1/30/95

A-22

**EXPERIMENTAL PROGRAM
FOR DORVAL NATURAL PRECIPITATION FLAT PLATE TESTING
1994 - 1995**

This document provides the detailed procedures and equipment required for the conduct of natural precipitation flat plate tests at Dorval for the 1994/95 winter season.

1. OBJECTIVE

To complete the substantiation of the existing SAE Holdover Time Tables and proposed table extensions by conduct of tests on standard flat plates as follows:

- Type I and Type II fluids under conditions of natural snow at the lowest temperature ranges.
- Type I fluids at dilutions for which a buffer of approximately 10°C from the fluid freeze point is maintained.
- At least two samples of a new family of "long-life" fluids will be tested to establish the holdover times over the full range of HOT Table conditions for this potential new fluids category.

2. TEST REQUIREMENTS (PLAN)

Attachment I provides the list (not in any order) of tests to be conducted at the Dorval test site located adjacent to AES. These tests shall be conducted during natural precipitation conditions.

3. EQUIPMENT

Test equipment required for the flat plate tests was determined in the last four years in association with the SAE working group. This equipment is listed in Attachment II.

FLAT PLATE TESTING

4. PERSONNEL

One test site supervisor and at least two testers per stand are required to conduct a test.

5. PROCEDURE

The modified test procedure is also included in Attachment II. This procedure was developed more than four years ago and was modified over the years to incorporate discussions at the SAE working group meetings.

6. DATA FORM

A data form is included with Attachment II.

**ATTACHMENT I
NATURAL PRECIPITATION TEST PLAN**

RUN #	TEMP DEG C	NUMBER OF PLATES TESTED	TYPE I* (De-Icing)						TYPE II (Anti-Icing)											
			HOECHST		ARCO PLUS		UCAR		OCT			OCT-NEW			KIL ABC-3/ARCO ABC-3			UCAR-ULTRA		
			50/50	DIL.	63/37	DIL.	XL54	DIL.	NEAT	75/25	50/50	NEAT	75/25	50/50	NEAT	75/25	50/50	NEAT	75/25	50/50
1	>0	6				2		2	2											
2	>0	6				2		2	2											
3	>0	6				2		2	2											
4	>0	6	2	2																
5	>0	6					2						2							
6	>0	6												2	2					2
7	>0	6												2	2					2
8	>0	6												2	2					2
9	>0	6																		
10	>0	6								2	2					2	2			
11	>0	6														2				
12	>0	6								2						2				2
13	>0	6														2				2
14	>0	6														2				2
15	>0	6								2										2
16	0 TO -7	6								2										2
17	0 TO -7	6													2	2				2
18	0 TO -7	6									2									2
19	0 TO -7	6																		2
20	0 TO -7	6					2		2	2										
21	0 TO -7	6						2		2										
22	0 TO -7	6					2		2											
23	0 TO -7	6	2	2																
24	0 TO -7	6					2													
25	0 TO -7	6								2										2
26	0 TO -7	6								2										2
27	0 TO -7	6														2				2
28	0 TO -7	6														2				2
29	0 TO -7	6									2	2								2
30	-7 TO -14	6					2		2	2										
31	-7 TO -14	6					2			2										
32	-7 TO -14	6					2		2											
33	-7 TO -14	6	2	2																
34	-7 TO -14	6					2													
35	-7 TO -14	6																		
36	-7 TO -14	6									2					2				2
37	-7 TO -14	6								2										2
38	-7 TO -14	6								2										2
39	-7 TO -14	6														2				2
40	-7 TO -14	6														2				2
41	-7 TO -14	6								2						2				2
42	-14 TO -25	6					2		2	2										
43	-14 TO -25	6					2			2										
44	-14 TO -25	6					2		2											
45	-14 TO -25	6	2	2																
46	-14 TO -25	6								2						2				
47	-14 TO -25	6								2						2				
48	-14 TO -25	6														2				2
49	-14 TO -25	6								2						2				2
50	-14 TO -25	6								2						2				2
51	<-25	6					2		2	2										
52	<-25	6					2			2										
53	<-25	6					2		2											
54	<-25	6	2	2																
55	<-25	6								2						2				
56	<-25	6								2						2				
57	<-25	6														2				2
58	<-25	6								2						2				2
59	<-25	6								2						2				2
TOTAL		354	10	14	20	26	20	46	30	8	10	40	12	18	38	4	0	40	12	8

* The dilutions should be based upon Table 2. XL54 (57% - 43%) and ARCO PLUS (63% - 37%) are commonly used in Canada.
Note: Type I fluid should be applied at Indoor Temperatures, while Type II fluids should be at Outside Air Temperatures.

ATTACHMENT II - TEST EQUIPMENT AND PROCEDURE

**ATTACHMENT II
FLAT PLATE FIELD TEST EQUIPMENT AND PROCEDURE
1994 - 1995**

This field test procedure has been developed by the Holdover Time Working Group of the SAE Committee on Aircraft Ground De/Anti-icing as part of an overall testing program that includes laboratory tests, field tests and full-scale aircraft tests, which is aimed at substantiating the holdover time table entries for freezing point depressant (FPD) fluids known as de/anti-icing fluids.

1. SCOPE

This procedure describes the equipment and generalized steps to follow in order to standardize the method to be used to establish the time period for which freezing point depressant (FPD) fluids provide protection to test panels during inclement weather such as freezing rain or snow.

2. EQUIPMENT

2.1 Rain/Snow Gauge

The following equipment or equivalent are recommended:

2.1.1 Tipping Bucket

2.1.1.1 Electrically Heated Gauge - Weathertronics Model 6021-B

collector orifice	200 mm diameter
sensitivity	1 tip/0.1 mm accuracy 0.5% @ 13 mm/hr
output	0.1 sec switch closure
voltage	115 v (model -D 230 v)
switch	A reed mercury wetted

2.1.1.2 Electromechanical Event Counter Option

Event counter (112 V DC # 115 V AC) Weathertronics Model 6422

ATTACHMENT II - TEST EQUIPMENT AND PROCEDURE

2.1.1.3 Digital Display Option

- (A) Event Accumulator - Weathertronics Model 1600
range 0-1000 counts
linearity 0.05%
- (B) Power Supply & Enclosure - Weathertronics Model 1020
- (C) LCD Digital Display - Weathertronics Model 1991

2.1.1.4 Ombrometer

Thies Model 5.4031.11.000, resolution 0.005 mm, maximum rate 2 mm/min (24 V DC). To be used with associated wind protection element.

2.1.1.5 PC Interface Option

- (A) Event Accumulator - Weathertronics Model 1600
- (B) Power Supply & Enclosure - Weathertronics Model 1025
- (C) PC Interface module - Weathertronics Model 1799

2.1.1.6 Fisher and Porter with Nipher Shield

This model, used at many Canadian airports, has a resolution of 0.1mm.

2.1.2 Manual Gauge

A manual standard rain and snow gauge can be used provided that the diameter of the gauge be as close as possible to 208 mm. This may not be possible in Europe therefore the diameter of the gauge must be reported with all tests results.

2.1.3 Cake Pan or Plate Pan

A large low cakepan (6"x6"x2" minimum) may be used to collect and weigh snow. A plate pan (the same area as a flat plate and 4 cm deep) may be preferable since it lies like the flat plates at a 10° incline. A schematic of the plate pan is provided as Figure 0.

Note: When this method is used the bottom and sides of the pan MUST BE WETTED (before each pre-test weighing) with de/anti-icing

ATTACHMENT II - TEST EQUIPMENT AND PROCEDURE

fluid to prevent blowing snow from escaping the pan.

2.2 Temperature Gauge

T or K type thermocouple thermometer capable of measuring outside air and panel temperatures to an accuracy of 0.5 degrees C (1 degree F) over the range +10 to -30 C (+50 to -20 F).

2.3 Test Stand

A typical test stand is illustrated in Figure 1; it may be altered to suit the location and facilities, but the angle for the panels, their arrangement and markings must all conform to Figures 1 and 2.

There shall be no flanges or obstructions close to the edges of the panels that could interfere with the airflow over the panels.

2.4 Test Panels

2.4.1 Material and Dimensions

Alclad Aluminum 2024-T6 or 5052-H32 polished standard roll mill finish 30x50x0.32 cm, for a working area of 25x40 cm. Thicker aluminum stock may be needed when an instrument is mounted on the plate.

2.4.2 Markings

Each panel shall be marked as shown in Figure 2 with lines at 2.5 and 15 cm from the panel top edge, with fifteen cross-hair points and with vertical lines 2.5 cm from each side; this marks off a working area of 25 x 45 cm on each panel. All marks shall be made using a 1/8" thick black marker or silk screen process, which does not come off with application of the test fluids or any of the cleaning agents. Remarking of the plates will be required as the markings fade because of the cleaning actions.

ATTACHMENT II - TEST EQUIPMENT AND PROCEDURE

2.4.3 Attachment

For attachment to the test stand, at least four holes shall be made, spaced along the two sides of each panel; the holes shall be within 2 cm from the panel edge.

2.5 Fluid Application

The fluid should be poured onto the plates from a manageable container, until the entire test section surface is saturated.

2.6 Film Thickness Gauge

Film thickness at the six inch line can be measured (this is optional). Painter's wet paint film thickness gauge. 1-08 mil gauge or equivalent is available from Paul N. Gardner Company Inc. Pompano Beach Florida.

2.7 Video recording

Where feasible a video recorder should be mounted to record salient events during testing. Care must be taken that the camera and any lighting do not interfere with the airflow or ambient temperatures.

2.8 Anemometer

Wind Minder Anemometer Model 2615 or equivalent. Available from Qualimetrics Inc. Princeton New Jersey.

2.9 Wind Vane

Model 2020 Qualimetrics or equivalent

ATTACHMENT II - TEST EQUIPMENT AND PROCEDURE

2.10 Relative Humidity Meter

Cole Parmer RH/Temperature Indicator P/N N-032321-00 with remote probe P/N N-03321030. Temperature limits -30 to 60°C RH range 20 to 100% accuracy $\pm 7\%$ (20-30%); = -5% (30-100%); or equivalent. Available from Cole Parmer Instrument Company Chicago Illinois.

2.11 Signal Conditioning Modules

Qualimetrics:

Enclosure/Power Supply Model 1020 (115 V AC)
Ombrometer Module Model 1600
Anemometer Module Model 1202
Temperature Module Model 1419-A
Relative Humidity Module Model 1500
Wind Vane Module

2.12 Computer Interface

Qualimetrics Model 1799-A, RS-232, 1 to 10 channels, 10 sec. to 1 hr. sampling rate.

2.13 Additional Equipment

- Squeegee
- Extension power cords
- Stopwatch
- Flood lights (2 x 500 watts)
- Pressurized space pens and water repellent paper
- PC to record meteorological data

3. DE/ANTI-ICING FLUIDS

3.1 Test Fluids

Only fluids that have been certified will be included in tests. Fluid suppliers shall submit to the test coordinating organization proof of certification for the fluids

ATTACHMENT II - TEST EQUIPMENT AND PROCEDURE

they provide.

3.2 Certification

Type II fluids shall be sheared by each manufacturer to that viscosity which would have been obtained by subjecting their fluids to the shear Stability Test found in the AEA Material specification revision C (October 1, 1988) paragraph 4.2.8.2.2.

Each manufacturer shall provide samples and a certificate of compliance showing the viscosity of their test sample of fluid before and after the Shear Stable Test. Test verifications of each fluid may be made at the University of Quebec at Chicoutimi (UQAC).

3.3 Dye

Fluids will be supplied for certification and for testing in the form to be used on aircraft.

3.4 Dilution of Type I Fluids

Type I fluids must be diluted as a function of outside air temperature according to Table 2. These concentrations were determined based upon information provided by the fluid manufacturers for which a buffer of 10°C from the fluid freeze point is maintained. When preparing the mixtures, verify with a refractometer that the percentage concentrations are accurate. Union Carbide products are based on Ethylene Glycol, while the Octagon and Arco products are composed of Propylene Glycol.

4. PROCEDURE

4.1 Setup

4.1.1 Panel Test Stand

If there is any wind, orient the test fixture such that the aluminum holdover test panels top surfaces are facing into the wind direction at the

ATTACHMENT II - TEST EQUIPMENT AND PROCEDURE

beginning of the test such that the wind is blowing up the panels

i.e. ----> /
 wind panel

If the wind shifts during the test do not move the fixture; simply note it on the data sheet.

4.1.2 Rain Gauge

Place the Rain Gauge as close as possible to the test fixture. Ensure that the interior level is used to indicate that the bucket is level. Ensure that the gauge is not shadowed by an object which would interfere with the collection for the snow or the freezing rain. If there is drifting snow it may be necessary to raise the snow gauge above the drift level but no higher than the test panel. The snow gauge measurements should be started as early as feasible and continue throughout the duration of all tests to provide a continuous record of precipitation.

4.1.3 Manual Cake Pan or Plate Pan Method

Add ¼ inch de/anti-icing fluid to the bottom of the pan as well as wetting the inner sides of the pan. Weigh the wetted pan prior to testing to the nearest gram. Weigh again after test completion to determine the true water content reading of the snow.

Use of more than one cake or plate pan is recommended to provide multiple readings through the course of the test period; mounting the pans on the test stand at the same orientation of the plates is recommended.

When using plate pans to measure precipitation rate, ensure that two plate pans are used. Care must be taken to ensure that snow or ice does not fall into the pans when transporting them into the trailer.

4.2 Test Panel Preparation

4.2.1 Before the start of each day's testing, ensure the panels are clean.

ATTACHMENT II - TEST EQUIPMENT AND PROCEDURE

4.2.2 Place the panels on the fixture and attach to the frame screws with flat bolts (wing nuts will make attaching and removal easier in poor weather)

4.2.3 Allow the panels to cool to outside air temperature.

4.3 Fluid Preparation and Application

4.3.1 Fluid Temperature

Except for Type I fluids, all fluids should be kept outside (cold-soaked to ambient temperature conditions) before tests start.

4.3.2 Cleaning Panels

Before applying test fluid to a panel, squeegee the surface to remove any precipitation or moisture.

4.3.3 Order of Application

Apply the fluid to the panels, commencing at the upper edge of the test panel and working downwards to the lower edge. Ensure complete coverage by applying the fluid in a flooding manner. Start with the top left panel U, then cover panel X in the second row with the same fluid, load the second test fluid on panel V followed by panel Y, etc. (see Figure 0).

4.4 Holdover Time Testing

4.4.1 Set the timer on as the first fluid application (plate u and x) is completed. Note the time when fluid application is completed on the remaining panels.

4.4.2 Commence recording the test with a video recorder until the test reaches the END CONDITION (see Section 5).

4.4.3 Record the elapsed time (holdover time) required for the precipitation to achieve the test END CONDITION.

ATTACHMENT II - TEST EQUIPMENT AND PROCEDURE

4.4.4 In heavy precipitation, continue the test until the precipitation reaches the bottom of the panel. Record the time for this event.

5. END CONDITIONS

The plate failure time is that time required for the end conditions to be achieved.

This occurs when the accumulating precipitation fails to be absorbed at any five of the crosshair marks on the panels.

A crosshair is considered failed if:

- There is a visible accumulation of snow (not slush, but white snow) on the fluid at the crosshair when viewed from the front (i.e. perpendicular to the plate). You are looking for an indication that the fluid can no longer accommodate or absorb the precipitation at this point.

OR

- This condition is only applicable during freezing rain/drizzle ice pellets, freezing fog or during a mixture of snow and freezing rain/drizzle and ice pellets. When precipitation or frosting produces a "loss of gloss" (i.e. a dulling of the surface reflectivity) or a change in colour (dye) to grey or greyish appearance at any five crosshairs, or ice (or crusty snow) has formed on the crosshair (look for ice crystals).

As these determinations are subjective in nature, the following is very important:

- Whenever possible, have the same individual make the determination that a crosshair has failed.
- When making such a determination, ensure consistency in the criteria used to call the end of a test.
- Under light snow conditions, snow may sometimes build up on the fluid and then be absorbed later as the fluid accommodates (absorbs) for it. If this occurs, record the first time snow builds up and note (in the comments sections) that there was an "un-failure" at a specific crosshair.

ATTACHMENT II - TEST EQUIPMENT AND PROCEDURE

Under conditions of moderate to heavy snow or hail, coverage may be very uneven; this measure should indicate failure over about one-third of the panel.

6. END OF TEST

Record the type and extent of contamination on the control plate. For example note if the plate is covered in a light fluffy snow, or light ice, or any other distinguishing features of the contamination. Record the type of snow according to the classification in Figure 3.

Once the test has ended, wipe the plates and cleanse with isopropyl alcohol and/or pure glycol. Restart the testing procedure and continue as long as the weather conditions warrant.

7. REPORTING & OBSERVATIONS

Calculate and record test data, observations and comments in the format of Table 1. Each test must be conducted in duplicate. Detailed definitions and descriptions of meteorological phenomena are available in the Manual of Surface Weather Observation (MANOBS).

**FIGURE 0
SCHEMATICS OF PLATE PAN AND TEST STAND**

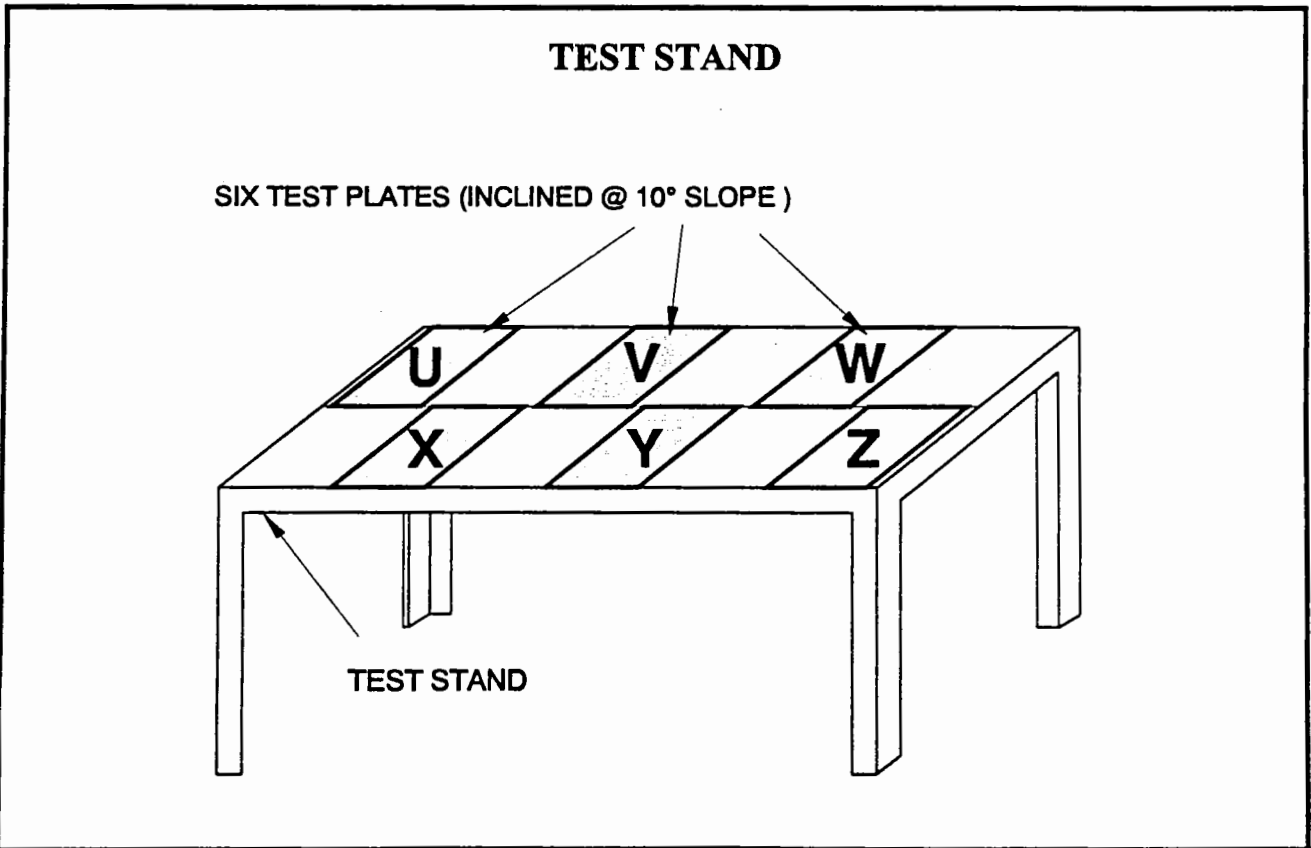
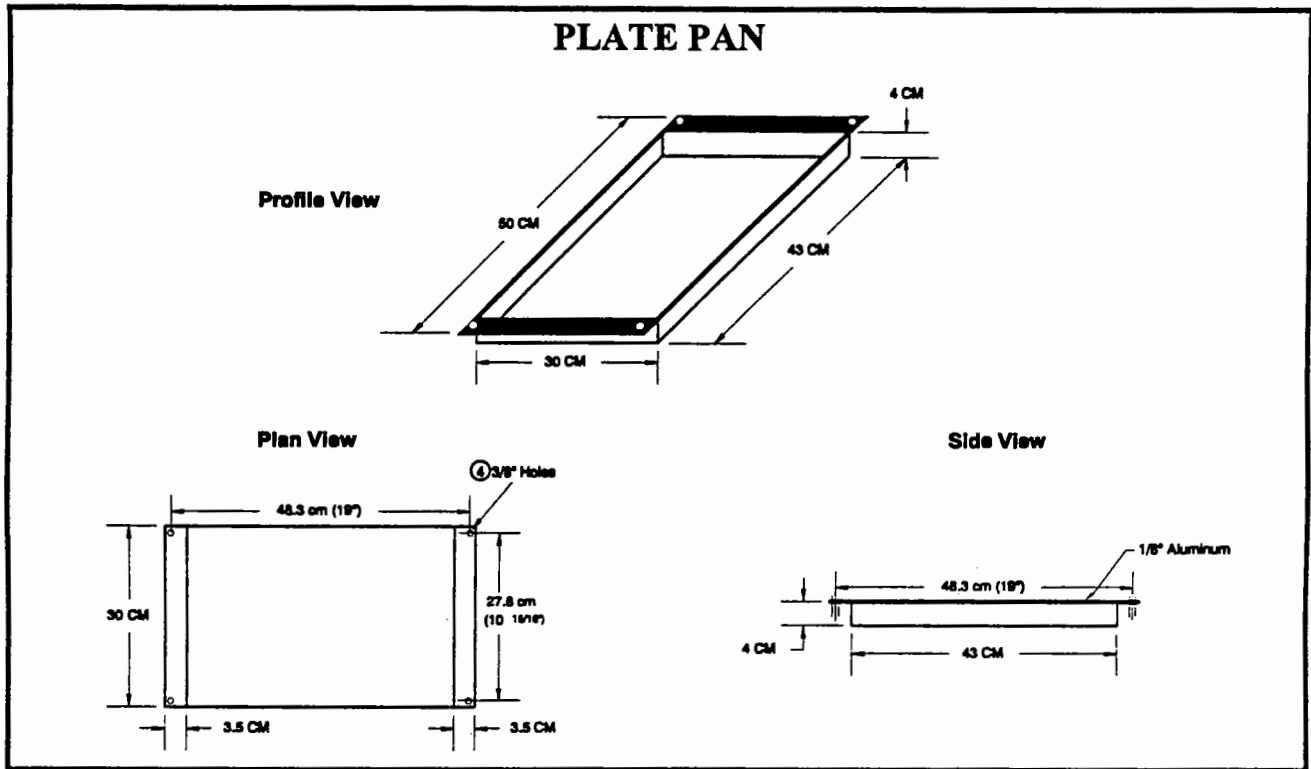

b2886ofenvgpanstand.dwg

FIGURE 1 TEST STAND

DRILL 25/64 HOLE THRU. &
TACK WELD 2/8-16 UNC.X 3/4 BOLT
TO BE USED WITH WING NUT

1 1/4 ANGLE IRON TYP.

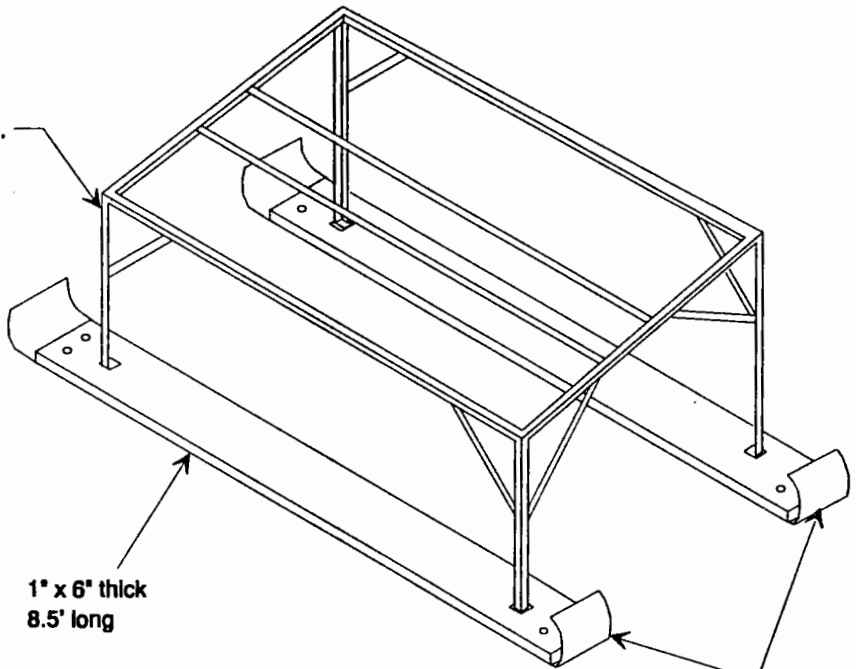

1" x 6" thick
8.5' long

Metal ski at both ends bolted
onto a 1" x 6" piece of wood.

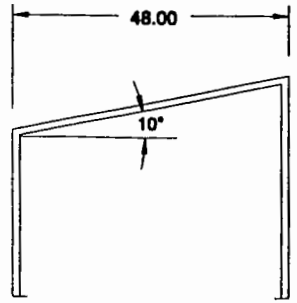
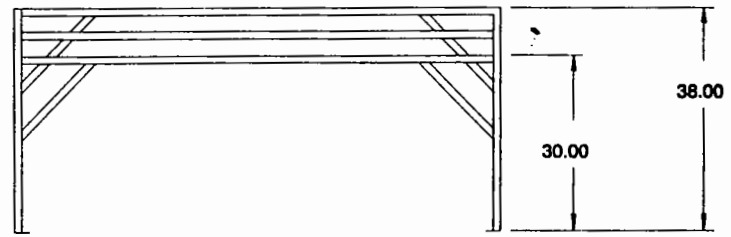
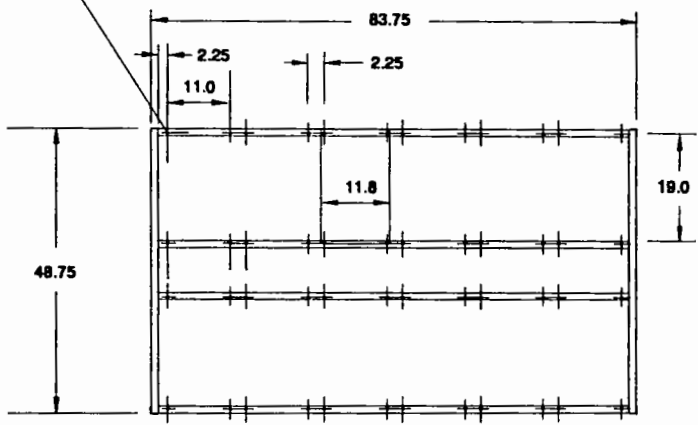

ALL DIMENSIONS IN
INCHES EXCEPT WHERE
OTHERWISE SPECIFIED

A-37

**FIGURE 2
FLAT PLATE MARKINGS**

TYPICAL PLATE

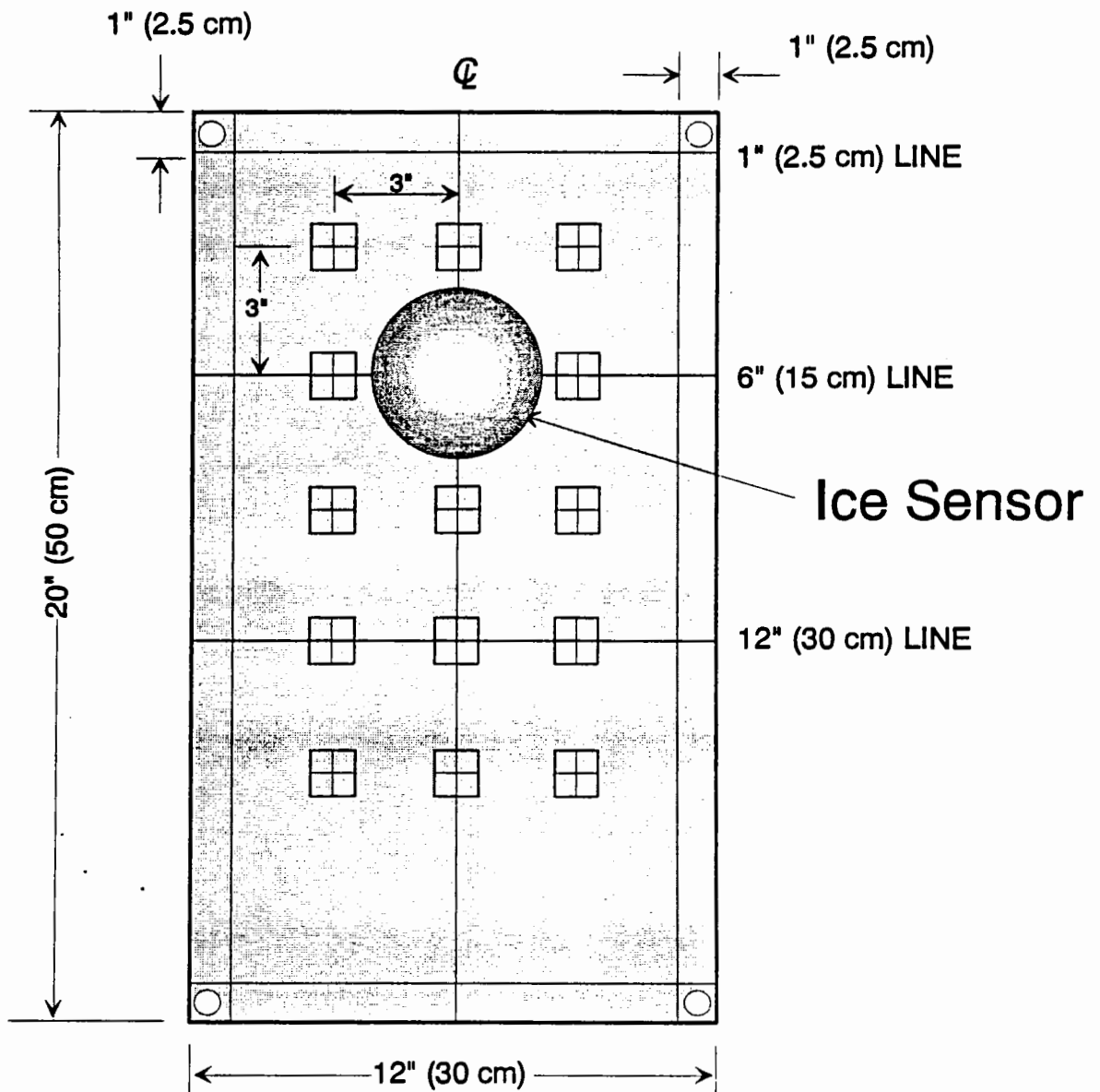

TABLE 1

DE/ANTI-ICING DATA FORM

VERSION 2.2

Winter 94/95

REMEMBER TO SYNCHRONIZE TIME

LOCATION: _____ DATE: _____ RUN NUMBER: _____ STAND #: _____ CIRCLE SENSOR PLATE: u v w x y z
 Time After Fluid Applied to Plates U and X: _____ am / pm SENSOR NAME: _____

RVSI Series #: _____ Frame #: _____

COLLECTION PAN: PAN # _____ PAN # _____
 Before After Before After

Weight of Pan (g) _____

Collection Time (min) _____

DIRECTION OF STAND: _____

CONTROL PLATE COMMENTS: _____

PRECIP: ZR ZL S SW IP IC BS SP ++ + - ..

SNOW/RAIN CATEGORIES (use velvet & classification): _____

OTHER COMMENTS (Fluid Batch, etc): _____

FAILURES CALLED BY: _____

HAND WRITTEN BY: _____

ASSISTED BY: _____

*TIME (After Fluid Application) TO FAILURE FOR INDIVIDUAL CROSSHAIRS (MINUTES)

Time of Fluid Application: _____ mins (V & Y) _____ mins (W & Z)

	Plate U			Plate V			Plate W		
FLUID NAME									
B1 B2 B3									
C1 C2 C3									
D1 D2 D3									
E1 E2 E3									
F1 F2 F3									
TIME TO FIRST PLATE FAILURE WITHIN WORK AREA									
TIME OF SLUSH FORMATION ON SENSOR HEAD	1st	1/2	Full	1st	1/2	Full	1st	1/2	Full

	Plate X			Plate Y			Plate Z		
FLUID NAME									
B1 B2 B3									
C1 C2 C3									
D1 D2 D3									
E1 E2 E3									
F1 F2 F3									
TIME TO FIRST PLATE FAILURE WITHIN WORK AREA									
TIME OF SLUSH FORMATION ON SENSOR HEAD	1st	1/2	Full	1st	1/2	Full	1st	1/2	Full

* To Compare to previous years of testing, subtract "Time of Fluid Application".

TABLE 2





































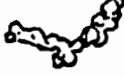

PERCENTAGE OF GLYCOL MIXTURE WITH WATER (%) AS A FUNCTION OF OAT USED FOR DILUTED TYPE I TESTS TO ACHIEVE A 10°C BUFFER

Outside Air Test Temperature (°C)	Fluid Freeze Point (°C)	B-250* (Dilution)	B-251* (Dilution)	B252* (Dilution)	B-253*	
					(Dilution)	(Brx)
0 °C	-10 °C	28%	28%	31%	23%	14
-2 °C	-12 °C	31%	31%	35%	26%	16
-4 °C	-14 °C	35%	34%	39%	29%	18
-6 °C	-16 °C	37%	37%	42%	31%	19.7
-8 °C	-18 °C	40%	40%	45%	34%	21.2
-10 °C	-20 °C	42%	42%	48%	36%	22.5
-14 °C	-24 °C			50%**		24.8
-15 °C	-25 °C	47%	48%	53%	41%	25.5
-20 °C	-30 °C	52%	52%	58%	46%	27.9
-25 °C	-35 °C	56%	57%	63%	50%	30
-30 °C	-40 °C	60%	TBD	67%	54%	32
-33 °C	-43 °C		TBD		57%**	33
-35 °C	-45 °C	63%**	63%**			33.7

* Based on a 10°C buffer. † Based on a 10°C buffer. If verifying the glycol concentration/freeze point with a refractometer, note that the freeze point will be 10°C lower.

** Standard Type I mixtures

INTERNATIONAL CLASSIFICATION FOR SOLID PRECIPITATION

Graphic Symbol	Examples			Symbol	Type of Particle
				F1	Plate
				F2	Stellar crystal
				F3	Column
				F4	Needle
				F5	Spatial dendrite
				F6	Capped column
				F7	Irregular crystal
				F8	Graupel
				F9	Ice pellet
				F0	Hail

4. A pictorial summary of the International Snow Classification for solid precipitation. This classification applies to falling snow.

Source: International Commission on Snow and Ice, 1951

APPENDIX B
INSTRUMAR TEST PROCEDURES

INSTRUMAR Limited
Ground Static Test Plan and Procedure
Manual

DOC. NO.: TPL/0514/001

Rev -

DATE: 28 November, 1995

WRITTEN BY: _____

APPROVED BY: _____

This document contains information which is proprietary to INSTRUMAR Limited and is to be used by the recipient solely for the purpose for which it was supplied.

INSTRUMAR Limited
P. O. Box 13246, Stn. A
St. John's, Newfoundland
Telephone: (709) 726-8460
Fax: (709) 726-8613

REVISIONS			
REV	PAGE(S)	DESCRIPTION	DATE
DRAFT		Initial Release	February 17, 1995
-		Release	November 28, 1995

Contents

1	Summary	1
2	Introduction	2
2.1	Responsibility Overview	2
2.2	Wing Grid Structure	2
2.3	Definition of Fluid Failure	4
3	Responsibility Details	5
3.1	Observer	5
3.1.1	Test Equipment	8
3.2	Recorder	9
3.2.1	Test Equipment	10
3.3	Cockpit Recorder	10
3.3.1	Test Equipment	11
3.4	Floating Coordinator	11
3.4.1	Neutral Zone setup	12
3.4.2	Test Equipment	12
3.5	Temperature Measurement Person	13
3.5.1	Test Equipment	14
3.6	Flat Plate Observer	14
3.6.1	Test Equipment	16
3.7	Video Camera Operator	17
3.7.1	Voice Information	17
3.7.2	Flat Plate Photo Sequence	17
3.7.3	Aircraft Wing Photo Sequence	18
3.7.4	Test Equipment	20
4	Test Procedure	21
4.1	Pre-Test Procedures at INSTRUMAR	21
4.2	Airport Sequence of Activities	22
4.3	Post-Test Procedures at INSTRUMAR	25
5	Flat Plate Procedures	26
5.1	Plate Identification	26
5.2	Fluid Application Procedures	26
5.3	Cross Hair Markings	27
5.4	Failure Identification	27
5.5	Cleaning Procedures	29
5.6	Flat Plate FPD Fluid Preparation	29
5.7	Plate Pan Procedures	30

6	Experiment Concerns	31
6.1	External Clothing Arrangements	31
6.2	Safety	31
6.3	General	32
A	Static Test Forms	33
A.1	Floating Coordinator - ASTP_FCF	33
A.2	Floating Coordinator - ASTP_FCO	34
A.3	Observer (Left) - ASTP_OBW (A320)	35
A.4	Observer (Right) - ASTP_OBW (A320)	36
A.5	Observer (Left) - ASTP_OBW (DC-9)	37
A.6	Observer (Right) - ASTP_OBW (DC-9)	38
A.7	Observer (Left) - ASTP_OBW (B-737)	39
A.8	Observer (Right) - ASTP_OBW (B-737)	40
A.9	Observer (Left) - ASTP_OBW (RJ)	41
A.10	Observer (Right) - ASTP_OBW (RJ)	42
A.11	Observer (Left) - ASTP_OBW (BAe-146)	43
A.12	Observer (Right) - ASTP_OBW (BAe-146)	44
A.13	Flat Plate Observer - ASTP_FPO	45
A.14	Flat Plate Observer - ASTP_FPI	46
A.15	Recorder - ASTP_REC	47
A.16	Cockpit Recorder - ASTP_CPR	48
B	XL54 - De/Anti-Icing Fluid Information	49

List of Figures

1	Position Locations on Aircraft and Tarmac.	4
2	Wing Structure Grid.	5
3	Location of Flat Plates on Test Stand Mount Frame.	26
4	Flat Plate Illustration.	28

List of Tables

1	Identification and Aircraft Location of Team Members.	3
2	Precipitation Identification Nomenclature.	15
3	Glycol Concentration Based on 10°C Buffer.	29

1 Summary

This report contains the test plan and procedures required to implement a ground static test experiment. INSTRUMAR Limited was contracted by Aviation Planning Services to conduct five static tests at St. John's International Airport, Newfoundland, Canada, during the 1994/1995 winter season. INSTRUMAR Limited modified their static test procedures to meet the requirements of Aviation Planning Services. The Aircraft Static Test Program initiative involved the simultaneous de-icing of both aircraft wings and two sets of flat plate stands.

The purpose of the Aircraft Static Test Program initiative is to correlate the performance of aircraft Freezing Point Depressant fluids applied on 10° inclined flat plates to the performance of those fluids applied to an aircraft. The aim is to validate flat plate testing as a reliable source of information.

2 Introduction

Each ground static test in INSTRUMAR's^{TM1} Aircraft Static Test Program (ASTP) initiative will fundamentally consist of the following three tasks:

1. simultaneous aircraft/flat plate de-icing events;
2. monitoring the integrity of the de-icing fluid; and
3. identifying and recording fluid failure.

Prior to commencing the first static test, a pre-test run will be conducted. This exercise ensures that all program logistics have been considered and the test progresses smoothly. It will also provide a means where by each person will understand their duties and responsibilities to the fullest.

2.1 Responsibility Overview

Table 1 lists the personnel included in the ASTP initiative, their assigned location and their function. The location of each position relative to the aircraft is illustrated in Figure 1. Each person will be identified as either an *Observer* (O), a *Flat Plate Observer* (FPO), a *Recorder* (R), a *Floating Coordinator* (FC), a *Video Camera Operator* (VCO) or a *Temperature Measurement* (TM) person. In total there will be 11 personnel on site: 4 Observers, 2 Flat Plate Observers, 2 Recorders, 2 Video Camera Operators and 1 Temperature Measurement person. The Floating Coordinator responsibility will be given to the persons identified with the symbol "*".

The people involved in the ASTP initiative are divided into two teams. This division is based on which side of the aircraft personnel will be located: *Left Team* and *Right Team*. Once the fluid is applied, each team will be responsible for observing, reporting and recording the various fluid failure states the aircraft wings and flat plates undergo before fluid failure. The Temperature Measurement person independently performs their duties.

2.2 Wing Grid Structure

During each static test, Observers assigned to the wing sections are required to identify various states of fluid failure, two of which are 1) the first observed failure of freezing point depressant (FPD) fluid and 2) the first square foot of failed FPD fluid. To facilitate this, each wing section was divided into three subsections:

1. Leading Edge (L);

¹INSTRUMAR is a registered trademark of INSTRUMAR Limited

Location	Aircraft Position	Personnel
LEFT TEAM		
1	Left Outer Wing [O]	Chris Nolan
2	Left Inner Wing [O]	Keith Manuel*
3	Left Flat Plate Stand [FPO]	Darryl Pike*
4	Left Cabin [R]	John Hall
RIGHT TEAM		
5	Right Outer Wing [O]	Stuart Inkpen
6	Right Inner Wing [O]	Dana Linfield
7	Right Flat Plate Stand [FPO]	Heather Spearns
8	Right Cabin [R]	Warren Barbour
OTHER POSITIONS		
9	Temperature Measurement [TM]	Glen White
10	Video Camera Operator [VCO1]	Chris Marshall
11	Video Camera Operator [VCO2]	Alfred Marshall
BACKUP POSITIONS		
12	Cockpit Recorder [CR]	Nick Maltsev
13	Cabin [R]	Robert Vivian
14	Observer [O] or VCO	Dyn'se Burton
15	Observer [O]	Chris Dawson
16	Flat Plate Observer [FPO] or TM	Gerard Galway

Table 1: Identification and Aircraft Location of Team Members.

2. Middle (M); and
3. Trailing Edge (T).

This is further clarified by considering the illustration in Figure 2. The trailing edge is defined as the area between the inner edge of the aileron and flap hinges and the trailing edge of the wing. This is easily identified visually on the actual wing surface. The leading edge is also easily identified by a highly visible seam in the aluminum skin. It is where the curvature of the upper wing surface begins to taper off and round out towards the under wing surface. The remaining wing section is referred to as the Middle. The aircraft wing structure is also marked 1 through 7 to produce a grid structure. This grid structure allows personnel to identify the sections for which they are responsible and to make the assigned observation calls. This aircraft wing grid structure was defined and provided to INSTRUMAR by Aviation Planning Services (APS). There are five possible aircraft wing profiles, however, the fundamental grid structure remains the same. The five aircraft frames are: A320, DC-9, B-737,

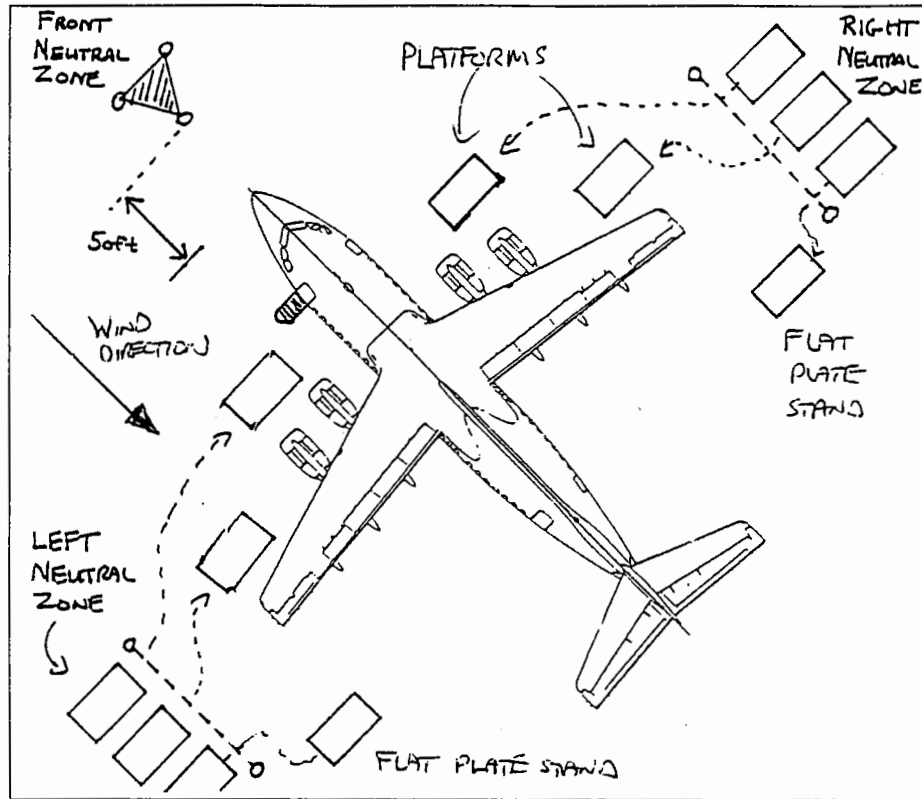

Figure 1: Position Locations on Aircraft and Tarmac.

RJ and BAe-146.

2.3 Definition of Fluid Failure

During falling snow precipitation conditions, the following definition is used to identify fluid failure: When there is a visible accumulation of snow (not slush but white snow) on the fluid surface. This occurs when the de-icing fluid can no longer accommodate or absorb anymore precipitation.

During freezing rain conditions, the following definition is used to identify fluid failure: When precipitation or frosting produces a "loss of gloss" (i.e. a dulling of the surface reflectivity) effect on the surface of interest. This definition is used not only under freezing rain precipitation conditions but also under freezing drizzle, ice pellets and freezing fog or during a mixture of snow and freezing rain/drizzle and ice pellets.

These definitions originated from APS's flat plate test plan and procedures manual and have been modified to account for both aircraft surface and flat

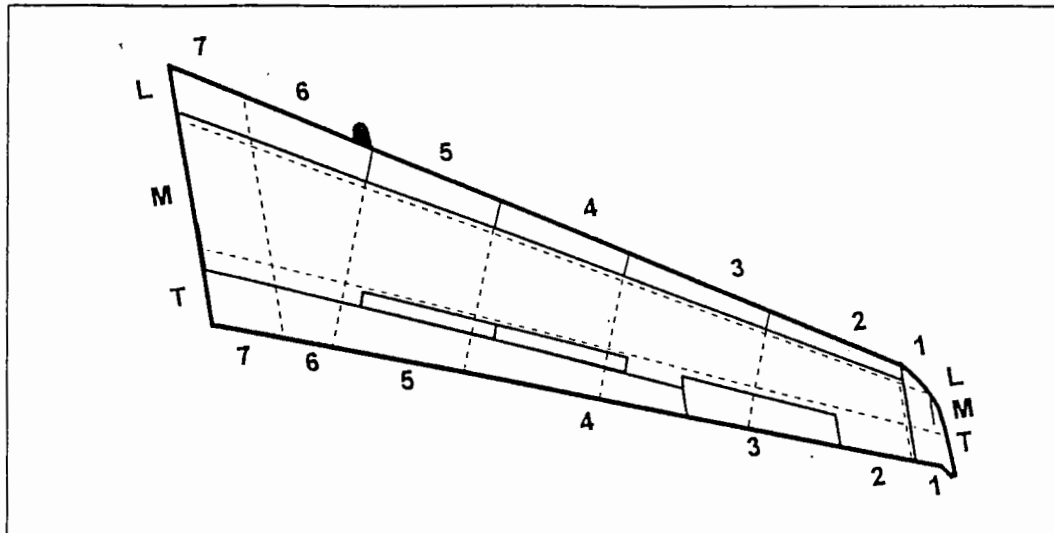

Figure 2: Wing Structure Grid.

plate surface fluid failure identification.

3 Responsibility Details

3.1 Observer

An Observer (O) is responsible for monitoring the FPD fluid after application on the aircraft wing. Monitoring the fluid will be facilitated with the use of a platform. Depending on the aircraft being monitored the platform may be a mobile raised platform or a cherry picker. There are two Observers per wing section: an inner Observer and an outer Observer. The outer Observer is responsible for monitoring wing grid sections 1, 2, 3 and 4. The inner Observer is responsible for monitoring wing grid sections 5, 6 and 7.

During the fluid application, the Observers will remain in the designated *Front Neutral Zone* (see Figure 1). When the fluid application begins on the right wing section, the right outer wing observer will call the right cabin Recorder and identify the right wing *Fluid Application Start Time*. Upon completion of the fluid application, the right outer wing observer will call the right cabin Recorder and identify the right wing *Fluid Application End Time*. After the fluid application on the right wing section has been completed the right inner and right outer wing Observers should proceed to their identified *Right Neutral Zone* and initiate the platform setup arrangements. When the right inner and right outer wing Observers are positioned and fluid integrity moni-

toring begins the Observers are responsible for individually contacting the right Recorder and indicating that fluid monitoring has commenced. When the fluid application begins on the left wing section, the left outer wing observer will call the left cabin Recorder and identify the left wing *Fluid Application Start Time*. Upon completion of the fluid application the left outer wing observer will call the left cabin Recorder and identify the left wing *Fluid Application End Time*. After the fluid application on the left wing section has been completed the left inner and left outer wing Observers will proceed to their identified *Left Neutral Zone* and initiate the platform setup arrangements. When the left inner and left outer wing Observers are positioned and fluid integrity monitoring begins the Observers are responsible for individually contacting the left Recorder and indicating that fluid monitoring has commenced.

The Observer positions require one form, ASTP_OBW, for each wing. The overall form is generic, however, the wing profiles correspond to the left and right wing sections. Since there are five aircraft structures which will be possibly available, there are five separate forms:

1. the A320 wing structure form;
2. the DC-9 wing structure form;
3. the B-737 wing structure form;
4. the RJ wing structure form; and
5. the BAe-146 wing structure form.

Irrespective of the wing structure being used the Observer will transmit to the cabin Recorder the following changes as they occur:

1. *Observation Start Time Stamp*: This time stamp represents the time at which the Observer first begins observing their designated test site.
2. *First Failure*: This event is communicated upon the onset of first observed fluid failure on each of the L, M or T, sections of the surface being observed. This is where the fluid starts to "seed". In total, three time stamps are required per Observer: one for the leading edge, one for the middle and one for the trailing edge.
3. *10% 25%, 50%, 75% and 100% Time Stamp*: These events are communicated when there appears to be approximately 10% 25%, 50%, 75% and 100% of failed fluid on the leading edge, middle and trailing edge of the wing section assigned. There is one observation time stamp required for each of the sections: L, M and T. Hence, eighteen time stamps in total are required per Observer.

4. *First Failure, 10% Rep., 50% Rep. and 100% Rep.:* These events are communicated when first failure is observed on the representative surface and when there appears to be 10%, 50% and 100% of failed fluid on the aircraft wing's representative surface. These observations are only required from the inner observer and also when there is a designated representative surface. For example, the BAe-146 does not have a representative surface.
5. *C/FIMS^{TM2} Time Stamp:* Two times are recorded, the first when the Observer identifies fluid failure on the sensor head and the second when the sensor head is completely covered. This information is only required by the outer left wing and outer right wing Observers and only when an aircraft with a C/FIMS is being used.

The Observer's form is photocopied onto a transparency. This water proofs the form and in turn protects it from prevailing weather conditions and allows pertinent information to be recorded. Marking on the transparency is facilitated with a *China Marker*. The following information is recorded on the form itself:

1. First fluid failure "seed" locations. In total, three failure location sites are required: one for the leading edge, one for the middle and one for the trailing edge.
2. The first failed square foot "patch" location. In total, three first failed square foot patch failure location sites are required: one for the leading edge, one for the middle and one for the trailing edge. This represents the 10% fluid failure event.
3. The first fluid failure "seed" locations and first failed square foot "patch" location are required for the representative surface.
4. The progression of fluid failure.

The inner and outer Observer will both provide this information. Once inside the hanger the markings should be transferred on to the original form.

The *China Markers* are extremely durable and have been tested in a cold chamber at -10°C under simulated freezing rain. Caution will be used, however, when handling the form because rubbing the markings excessively will remove the markings. Other information noted by the Observer can be added to the form at their discretion.

²Contaminant/Fluid Integrity Monitoring System (C/FIMS) is a registered trademark of AlliedSignals Limited.

Communication between the four Observers and the cabin Recorders will be via VHF radios. Observer's will use their wing section location, *Left Outer*, *Left Inner*, *Right Outer* or *Right Inner*, as caller IDs. Each time the recorder is contacted the caller ID will precede any communication. This will serve as a reference ID to the recorder. For example, if the left outer wing Observer was calling in the 50% failure time stamp for the leading wing section the person would state, "Left Recorder..... Left Outer.... 50%..... Leading Edge". All transmissions will be repeated by the respective left and right Recorder for message verification.

For reference, information transmitted to the Recorder during each test is included on the Observer Form. If the Observer finds it is difficult to keep track of what information has been transmitted to the Recorder, they may place a check mark or dot in the space provided.

The *Comment* section is provided for the Observer to document any additional observations or concerns which occur during the static test. Comments may include precipitation transitions, for example, freezing rain to snow, and the progression of fluid failure.

The Observers will continue to monitor the aircraft until instructed by their team Recorder. A portion of the failed fluid may be squeegeed from the aircraft surface to investigate whether or not the fluid has failed to the point where the freezing precipitation has adhered to the surface. Once the test has been classified as terminated it is the responsibility of the Observer to ensure that their platforms are positioned back to their respective *Neutral Zone*. The platform's wheel locks should be disengaged and the platform manually returned. If cherry pickers are used then the booms should be returned to their rest position and the drivers instructed to back away from the aircraft.

With the platforms and/or cherry pickers behind the *Neutral Zones* all Observers will proceed toward the designated rendezvous point. Once there, all information on the transparency will be transferred to the original form. Also, *Date*, *Test ID* and *Inner/Outer* information should be recorded. This will complete the form on site. The transparency is then cleaned in preparation for the next test.

3.1.1 Test Equipment

The Observer will be supplied with the following equipment:

1. a Radio;
2. a flash light;
3. a scraper/squeegee;
4. a writing board and *China Marker*;

5. Observer data sheet: Form ASTP_OBW (left or right). Both transparency and paper versions will be provided; and
6. Tissue, for cleaning prescription glasses(if applicable) and transparency.

3.2 Recorder

A Recorder (R) is responsible for logging the information pertaining to form ASTP_REC. Clock synchronization will occur before the static test begins. There are five main sections on the form:

1. *Identification Details*: This section is mostly completed before the application of fluid on the aircraft. Also contained in this section are three time stamps:
 - (a) *Fluid Application Start Time*,
 - (b) *Fluid Application End Time*, and
 - (c) *Termination of Test*.

Items, *a* and *b* are to be transmitted by the respective left and right outer wing Observers while located in the *Front Neutral Zone*. Termination of the test will be transmitted to the Recorder by the Floating Coordinator. If all wing sections have failed then the Recorder(s) will call the static test terminated.

2. *Outer Wing and Inner Wing*: The Observer for each position is determined and recorded before each test. The *Observer Start Time* entry is a time stamp that corresponds to when the Observer begins to monitor his or her section. Each Observer will contact the Recorder when this occurs.
3. *Important Events*: To be logged during the actual test. These time stamp entries have been described in detail under Observer responsibilities.
4. *C/FIMS*: This section is only considered when the aircraft being monitored has a C/FIMS unit installed. This information will be transmitted by the respective outer wing Observers. When the *100 percent* stamp is being recorded the Recorder will communicate to the Cockpit Recorder that the sensor is 100 percent covered. This is required for both the left and right wing mount time stamps.
5. *Comments*: This section is provided for recording additional observations or concerns.

A detailed description of the *Important Events*, the meaning of L, M, T, the representative surface and the C/FIMS items are described in both the Introduction and also in the section pertaining to the Observer. The above information is transmitted via two way radios from the Left Wing team and the Right Wing team to the left and right cabin Recorder. Each team will be transmitting on a different frequency.

If a transmission is unsuccessful the Recorder must contact the relevant Observer for retransmission. Using the Observer's full location name will facilitate proper identification, hence, a typical retransmission should follow this format, "Left Outer - Negative". It is also required to confirm a successful data log. This is accomplished by repeating the transmitted information back to the Observer.

If the C/FIMS installed aircraft is being used, the Recorder will indicate to the Cockpit Recorder to record the *PC Start time Stamp*.

3.2.1 Test Equipment

The Recorder will be equipped with the following:

1. a Radio;
2. Recorder data sheet: form ASTP_REC;
3. two regular pens; and
4. a clock/counter or stop watch.

The Recorders remains in the aircraft, or other designated site, at all times. Once the Floating Coordinator has terminated the static test and the Observers have been notified the Recorder(s) should proceed to the rendezvous site.

3.3 Cockpit Recorder

The Cockpit Recorder (CR) is responsible for logging the information pertaining to form ASTP_CPR. Only when the C/FIMS installed aircraft is being used will the Cockpit Recorder be required. The form has four main sections:

1. *Identification Details*: This section can be filled in prior to leaving the hanger.
2. *Pre-Fluid Application*: Before the de-icing fluid is applied to the aircraft, this section should be filled out.

3. *Post-Fluid Application*: The de-icing fluid will be applied on the left and right wing sections independently. This will allow approximately one minute between applications to fill in each of the two sections. As the cabin Recorder communicates to the Cockpit Recorder that the fluid application on each section is complete, the appropriate information should be recorded.
4. *100% Precipitation Coverage*: When the cabin recorders indicate to the Cockpit Recorder that the sensor is 100% covered in snow and/or freezing rain the *C/FIMS Installation* section should be filled in.
5. *Comments*: This section is provided to address any concerns which may occur during the static test. It is also provided to comment on whether or not the sensor is changes their readings. For example, alternating between *fluid* and *Other*. Also required is the *PC Start Time Stamp*.

While the Floating Coordinator(s) are setting up the *Neutral Zones* the Cockpit Recorder is responsible for connecting the laptop computer to the C/FIMS equipment located in the cockpit. When the Recorders and Floating Coordinator synchronize their digital clocks/counters the Cockpit Recorder should note the PC time in the *Comments* section.

3.3.1 Test Equipment

The Cockpit Recorder will be supplied with the following equipment:

1. Cockpit Recorder data sheet: form ASTP_CPR;
2. Two regular pens; and
3. laptop computer and interface unit.

The Cockpit Recorder will return to the hanger when instructed by the cabin Recorder or the Floating Coordinator.

3.4 Floating Coordinator

The Floating Coordinator(s) (FC) directs the static test program. This person ensures the operation is professional and adheres to the applicable safety and technical standards set forth. The Floating Coordinator will walk between all sites prior to the first application of the FPD fluid on the right wing section to ensure that the tarmac, aircraft and personnel are ready. All concerns which impede the static test progress should be brought to the attention of the Floating Coordinator immediately.

The Floating Coordinator is responsible for one form: ASTP_FCF. It contains three main sections:

1. *Identification Details*: This section can be almost filled in prior to the fluid application. The *fuel load* in each of the wing sections can be obtained from the cockpit display unit. Also required is the fuel temperature (*Tmp*). This location on the form is contained adjacent to the fuel load entry. The *Plane/Fin ID* number is the number of the plane which is located on the tail section of the aircraft.
2. *Fluid Application Details*: The Floating Coordinator will instruct the driver in the fluid application vehicle to record the amount of fluid applied to each of the wing sections. All the information in the *Fluid Application Details* section will be obtained from the driver in the fluid application vehicle prior to and after each test.
3. *Comments* : This section is provided to record any concerns which may occur during the static test. The aircraft and flat plate stand orientations are also recorded in this section.

Anything which impedes the progress of obtaining this information should be noted in the *Comments* section. When an experiment is either terminated or finished the Floating Coordinator will contact the cabin Recorder who will in turn contact all the Observers.

3.4.1 Neutral Zone setup

The Floating Coordinator is responsible for setting up the *Front*, *Left* and *Right Neutral Zones* (refer to Figure 1):

1. *Front Neutral Zone*: This zone is situated approximately 50 feet in front of the aircraft. Bright orange pylons define the triangular region. Each pylon will be at least 15 feet apart.
2. *Left Neutral Zone*: This zone is situated approximately 50 feet from the left wing tip in the direction away from the aircraft. Two bright orange pylons define the region. The pylons will be separated by at least 30 feet, 10 feet of space for each platform.
3. *Right Neutral Zone*: This zone is situated approximately 50 feet from the right wing tip in the direction away from the aircraft. Two bright orange pylons define the region. The pylons will be separated by at least 30 feet, 10 feet of space for each platform.

3.4.2 Test Equipment

The Floating Coordinator will be supplied with the following equipment:

1. a radio (Must designate Channel 1 or Channel 2 as prime);
2. data log form ASTP_FCF
3. compass;
4. four *China Markers* (One for use by the Floating Coordinator and three(3) spares);
5. a flash Light; and
6. a digital watch.

3.5 Temperature Measurement Person

The Temperature Measurement (TM) person is responsible for measuring the left and right wing surface temperature at specific sites. The form required by this task is ASTP_FCO and it consists of two main sections:

1. *Identification Details*: This section will be completed before the start of the test.
2. *Temperature Measurement Details* (left wing and right wing): Using the Temperature Probe, the aircraft surface temperature will be measured and recorded for the indicated sites. This will be done prior to the application of fluid(Before) and after the fluid has failed(After). After the de-icing on the right wing of the aircraft the TM person will continuously measure and record as often as possible the wing temperature at the designated locations until the static test is terminated. All temperature readings are in °C. To help couple the temperature probe to the surface of the aircraft the tip of the probe should be dipped in undiluted XL54 fluid.

Before each test the Temperature Measurement person is responsible for measuring and recording the following information:

1. Flat Plate Orientation:
 - (a) Right:
 - (b) Left:
2. Aircraft Orientation:
3. Aircraft Type: DC-9, A320, BAe-146, RJ or B-737.
4. Ambient Temperature:

5. Wind Direction:

If the wind direction with respect to the flat plates is not within $\pm 10^\circ$ notify the floating coordinator.

3.5.1 Test Equipment

The Temperature Measurement person will be supplied with the following equipment:

1. a voice recorder;
2. a temperature probe unit;
3. data log form ASTP_FCO;
4. a flash Light; and
5. a digital watch.

3.6 Flat Plate Observer

Flat plate Observers (FPO) are responsible for conducting all tasks associated within the flat plate test procedures. They are also responsible for logging the information pertaining to forms ASTP_FPO and ASTP_FPI. The first form is intended for outdoor use. It is photocopied onto a transparency. This water proofs and in turn protects the form from prevailing weather conditions and allows pertinent information to be recorded. Marking on the transparency is facilitated with a *China Marker*. The following information will be recorded on a voice recorder using form ASTP_FPO as a guide:

1. *Test Start Time*: This time stamp corresponds to the beginning of the fluid application on the aircraft wings. When the fluid application commences on the right side of the aircraft the right flat plate Observer will start his or her stop watch and record on the mini-recorder the stop watch time. When the fluid application commences on the left side of the aircraft the left flat plate Observer will start his or her stop watch and record on the mini-recorder the stop watch time.
2. *Fluid Application Time*: This is a time stamp which is recorded after the last flat plate has received fluid (flat plate Z). Each flat plate Observer will record this independently.
3. *Test End Time*: This is a time stamp which corresponds to the static test termination.

4. *Fluid Name*: The name of the fluid being applied to the flat plate. There is one for each of the flat plates.
5. *Failure Time*: The time corresponding to the failure of the flat plate. Each flat plate is marked with fifteen cross hair locations. When the de-icing fluid covering five of the cross hairs has failed the flat plate is considered failed. There is one failure time stamp required for each of the six flat plates.

Immediately after the *Test Start Time* is recorded the appropriate fluids are poured on to the flat plates in the specified order: U,X,V,Y,W and Z. Following this the precipitation plate pan covers are removed. Immediately after the *Test End Time* is recorded the precipitation plate pan covers are placed on the precipitation plate pans.

The second form, ASTP_FPO, is for use indoors and was obtained from Aviation Planning Services. The information on the form ASTP_FPO and the information recorded on the mini-cassette recorder are transferred to form ASTP_FPI inside the hanger after each test. All other information is written on the form during this time. Between each test all markings on the transparency will be removed.

The nomenclature used to identify precipitation conditions is contained in Table 2.

Precipitation Conditions	Code
rain	R
freezing rain	ZR
freezing drizzle	ZL
snow	S
wet snow	SW
ice pellets	IP
ice crystals	IC
blowing snow	BS
snow pellets	SP
++	heavy
+	moderate
-	light
--	very light

Table 2: Precipitation Identification Nomenclature.

There are two flat plate stands, one on the left side (A) of the aircraft and one on the right side (B) of the aircraft. The location of the stands are

illustrated in Figure 1. Assigned to each flat plate stand is one flat plate Observer.

The flat plate Observers will remain, unless otherwise under extraneous circumstances, on the sides or the back of the flat plate stand. These locations are important because it reduces interference the Observer may place on the interaction between the flat plate and the environment. For example, wind interference and precipitation interference.

Since the aircraft is positioned into the wind, the flat plate stand is located in front of the wing. This reduces the effects of wind turbulence on the flat plate test results.

There are three variations of XL54 FPD fluids required for the ASTP initiative. They are manually applied to each of the flat plates. There will be a container for each type of fluid being used. These containers are filled prior to aircraft de-icing. Also, the flat plates are cleaned before each test. Detailed information on the flat plate procedures are contained in Section 5.0.

3.6.1 Test Equipment

The Flat Plate Observer will be supplied with the following equipment:

1. a refractometer;
2. a three FPD fluid containers;
3. a thermocouple to measure FPD fluid temperature;
4. a flat Plate Observer form: Form ASTP_FPO and ASTP_FPI;
5. a clip board/*China Markers* jig;
6. a flash Light;
7. a role of paper towels;
8. a squeegee;
9. a digital scale;
10. one flat plate stand and six flat plates;
11. two precipitation plate pans and covers; and
12. a stop watch/counter.

3.7 Video Camera Operator

The Video Camera Operator (VCO) is responsible for visually recording fluid failure on both the flat plate setups and the aircraft wings. Since there are two VCOs and the duration of each test will typically be six to fifteen minutes, one VCO will be assigned to record the C/FIMS flat plate stand setup and one VCO will be assigned to a wing section.

The VCO will synchronize the video recorder's internal clock with the *Time Base* of the cabin Recorder. This is accomplished by setting the two time bases before the beginning of the first test on a particular evening.

3.7.1 Voice Information

There is no form which the VCO is required to fill out, however, prior to the start of each test the following information will be recorded on the audio portion of the video. This information is referred to as voice information.

1. test location: St. John's International Airport;
2. aircraft carrier: Air Canada or Air Atlantic;
3. aircraft type: A320, DC-9, B-737, RJ or BAe-146;
4. test ID;
5. date;
6. assigned position:
 - (a) flat plate (left/right);
 - (b) inner wing (left/right); or
 - (c) outer wing (left/right).
7. type of fluid used; and
8. VCO operator name.

3.7.2 Flat Plate Photo Sequence

The following list contains the items which will be recorded by the VCO assigned to the flat plate test station:

1. Voice information;
2. Before fluid application:
 - (a) an overall view of the tarmac;

- (b) a wide shot of both flat plate stands;
 - (c) zoom in on the C/FIMS flat plate installation;
 - (d) the aircraft;
 - (e) placement of the stands in relation to the aircraft; and
 - (f) precipitation conditions.
3. Record the six flat plates being cleaned with squeegee.
 4. Fluid being transferred from fluid application truck to fluid application containers. Ensure that the measuring the temperature of the fluid in the containers is recorded;
 5. Fluid being poured on the the six flat plates. Attempt to get wing fluid application in background. VCO will get full view of flat plate stand in picture;
 6. After fluid application VCO will zoom in on the flat plates in the following order: U, V, W, X, Y and Z. The order is from left to right, top to bottom;
 7. The flat plate Observer should instruct the VCO to zoom in on cross hairs as they fail. Zoom out and wait until the VCO identifies another failure. Repeat this procedure until all flat plates have failed.
 8. Record the precipitation plate pans being covered and being weighed.
 9. Verbally state that the test has terminated.
 10. This terminates the VCO requirements.

3.7.3 Aircraft Wing Photo Sequence

The following list contains the items which will be recorded by the VCO during the aircraft wing test:

1. Voice information;
2. Before fluid application:
 - (a) an overall view of the tarmac;
 - (b) The equipment being set-up;
 - (c) precipitation conditions;
3. Fluid being applied to aircraft wing section (from a distance get the whole wing in the picture);

4. Record the Observers mounting their observation platforms;
5. Begin recording outer wing section or inner wing section. This will be assigned prior to the test;
6. Proceed to assigned wing section;
7. After fluid application VCO will zoom in on the assigned wing section and pan the length of the wing. This should take approximately 30 seconds;
8. Refocus on assigned section and record the most visible signs of impending fluid failure.
9. The Observer should instruct the VCO to record the failure points as they occur. The failure calls will be verbally recorded on the audio portion of the video.
10. Continue monitoring wing section until the test is terminated.
11. Record the wing temperature measurements as they occur.
12. After termination record the tarmac once more.
13. Verbally state that the test has terminated.
14. This terminates the VCO requirements

Throughout every static test recording there are a few items which should be kept in mind. These items are centered around making the viewing of the video easier:

1. Auto focus: If the camera goes out of focus point the camera on the tarmac in front of the object being recorded. Once the auto focus has regained clarity refocus on the object in question.
2. Pause: During the course of recording it may be necessary to change a battery, get up on a stand or walk some distance. For any discontinuities in the recording process the following items are required:
 - (a) before pausing, if possible, indicate why the pause is happening;
 - (b) after resuming indicate the test ID and why the pause happened.;
3. Comments: When possible make comments on the subject(s) and surroundings being recorded. For example, precipitation type, air temperature and what the Observers are doing.
4. Over Exposure: Sometimes the light being reflected off the flat plates over exposes the recording. Find a position which avoids this situation.

3.7.4 Test Equipment

The Video Camera Operator will be equipped with the following:

1. a mono-pod;
2. a video camera; and
3. a video camera light.

4 Test Procedure

4.1 Pre-Test Procedures at INSTRUMAR

Prior to going to the airport the following items must be done:

1. Contact Environment Canada Weather Office, Atmospheric Environment Service (AES), and continually monitor weather conditions at St. John's Airport.
2. Call Airport and initiate site visiting arrangements.
 - (a) Carrier:
 - i. Air Canada.
 - ii. Air Atlantic.
 - (b) Fluid Application Services:
 - i. Hudson General.
 - ii. Air Canada.
 - (c) Confirm aircraft type and its location.
 - (d) Transport Canada for ramp passes.
3. Identify and inform INSTRUMAR personnel of time and location of airport rendezvous point.
4. Use AES temperature information to mix Type I FDP XL54 fluid to give an approximate 10°C buffer.
5. Check radio transmission functions and batteries.
6. Keep a Box dedicated for stationary, data log sheets and first aid kit.
7. 20 regular writing pens.
8. Check *China Markers* for lead point sharpness.
9. Check Flashlights/Batteries.
10. Ensure flat plate FPD fluid containers are available and clean.
11. Ensure XL54 FPD fluid funnels are available and clean.
12. Ensure Thermocouple unit is functional.
13. Check to ensure new batteries are available for backup.
14. Arrange donuts/coffee requirements.

15. Clean orange pylons for *Neutral Zones*.
16. Check Temperature Probe unit(s).
17. Check Clock/Counter unit.
18. Check Floating Coordinator's, Recorder's and Flat Plate Observer's digital watch.
19. Check laptop computer/Batteries (required for C/FIMS installed aircraft).

4.2 Airport Sequence of Activities

Be prepared with warm clothes, rubber sole boots and gloves. Being comfortable will help ensure that discomfort doesn't impede the accuracy of the test results.

1. Pre-Test procedures
 - (a) meet at pre-arranged airport location.
 - (b) Distribution of facility, hanger passes.
 - (c) Distribute individual test equipment. Each person should re-check all equipment.
 - (d) Briefing:
 - i. Rehash responsibilities.
 - ii. Identify where Video Camera Operators will be positioned.
 - iii. Personnel locations.
 - iv. Designate prime communication channel: One or Two.
 - v. Time Synchronization Procedure.
 - vi. Aircraft safety.
 - vii. Personnel safety.
 - (e) Identify and introduce airport personnel to INSTRUMAR personnel.
 - (f) Synchronize cabin clock(by Recorder personnel) to Floating Coordinator digital watch and the laptop computer (if applicable) and the video recorders.
 - (g) Assemble stationary platforms, check wheel locks and bolts.
 - (h) Assemble flat plate stands and check the flat plate bolts for tightness.

- (i) Assemble flat plate stand lighting.
 - (j) Aircraft will be positioned towards wind.
 - (k) Ensure all aircraft de-icing and/or anti-icing systems are off.
 - (l) Proceed to aircraft. Personnel are responsible for bringing out and placement of their equipment.
 - (m) Simulate bringing the platforms to and from the *Left and Right Neutral Zones* and their position by the aircraft. Ensure that the four base wheel locks on the platforms are functional. If the platform is a cherry picker simulate bringing the truck to and from the aircraft location.
2. Initialization Procedures
- (a) Set-up *Neutral Zone* areas (TM person and one other person).
 - (b) Measure and record fuel loads and fuel temperatures in both wings (FC).
 - (c) Measure designated wing skin temperature sited using the temperature probe unit and a platform (FC and one other person). Remember the Floating Coordinator's wrist watch output is the test time base.
 - (d) Ensure that the driver in the fluid application vehicle receives the fluid application form ASTP_FAF and understands the applicable procedures (FC).
 - (e) Set-up C/FIMS data logger in cockpit (required for C/FIMS installed aircraft)
3. Position support platforms or cherry pickers away from the aircraft in the designated *Left and Right Neutral Zones* during the fluid application procedures. This will provide ample room for the fluid application vehicle to maneuver.
4. All Observers during each fluid application will proceed to front of aircraft where the *Front Neutral Zone* has been identified. The Recorder will proceed to the assigned position in the aircraft or some other position in the hanger.
5. Both flat plate Observers will obtain fluid from the fluid application vehicle, return to their flat plate stand positions and measure the temperature of the fluid. At this point in time the three variations of Type I XL54 FPD fluid will be positioned and ready to be poured.

6. The Floating Coordinator will initiate the fluid application from the *Front Neutral Zone* by a hand wave signal directed towards the fluid application personnel.
7. Application of FPD fluid of aircraft. When the FPD fluid first reaches the right aircraft wing surface, the right flat plate Observer will begin flooding each of the six flat plates with the appropriate fluid. When the FPD fluid first reaches the left aircraft wing surface, the left flat plate Observer will begin flooding each of the six flat plates with the appropriate fluid.
8. The outer left and right wing Observers will contact the respective cabin Recorders after each their wing sections have been de-iced.
9. After fluid application on the right wing section is complete the right outer and inner Observers will move to the *Right Neutral Zones* and begin positioning their platforms. After fluid application on the left wing section is complete the left outer and inner Observers will move to the *Left Neutral Zones* and begin positioning their platforms.
10. At this point in time, all necessary equipment will be positioned.
11. Upon reaching their identified location each Observer is responsible for calling the cabin Recorder and indicating that they have initiated their observations.
12. Fluid failure observation commences (Fill in forms).
13. After the left and right wing sections have been identified as failed personnel will wait on their platforms until instructed by the cabin Recorder(s).
14. Once the static test is terminated:
 - (a) Observers will reposition their platforms behind the *Neutral Zones*.
 - (b) Flat plate Observers:
 - i. Cover precipitation plate pans. Before placing the covers on the precipitation plate pans the excess snow and/or ice should be removed as best as possible. Once covered, bring both of them inside hanger, or other designated site, and clean the access snow/ice/water from the outside of the pans. Both pans will be individually weighed and the data recorded. Before weighing the pans remove the covers.

- ii. Bring the premixed XL54 three fluid containers in the hanger or other designated site. This maintains the de-icing fluid at approximately 20°C. The two containers which contain the de-icing fluid obtained from the de-icing truck should be emptied.
 - iii. Bring in thermocouple unit.
- (c) Obtain fluid application information from the de-icing truck operator. This is the responsibility of the floating Coordinator.
15. All personnel on tarmac proceed to hanger or another designated site.
 16. Any transmissions which were incomplete by the Observers to their respective Recorder will be addressed here. Transfer all information from transparencies onto the appropriate paper form. Prepare transparencies for next test. Return completed forms to the Floating Coordinator/team leader.
 17. Aircraft stabilization and Coffee break (approximately 20 minutes).
 18. Prepare for next test.
 19. Continue until all tests are complete.
 20. Return Facility/Hanger passes.
 21. Store platforms and flat plate stands.

4.3 Post-Test Procedures at INSTRUMAR

The day following each static test the following items will be addressed:

1. Check all returned test equipment;
2. Place radios in re-charger;
3. Clean precipitation plate pans (4) and the flat plates (12);
4. Address any concerns personnel have;
5. Review logged data for comments and check recorded information for clarity; and
6. File data forms.

5 Flat Plate Procedures

The procedures implemented during this portion of the ASTP initiative originate from Aviation Planning Services flat plate testing procedures, *Experimental Program for Dorsal Natural Precipitation Testing 1994/95*. Only the sections pertaining to freezing rain and snow are considered.

5.1 Plate Identification

Figure 3 illustrates the mounting locations of the six flat plates. They have been marked and will be identified as indicated. Each of the 12 flat plates and the two test stands are also marked according to their left or right position.

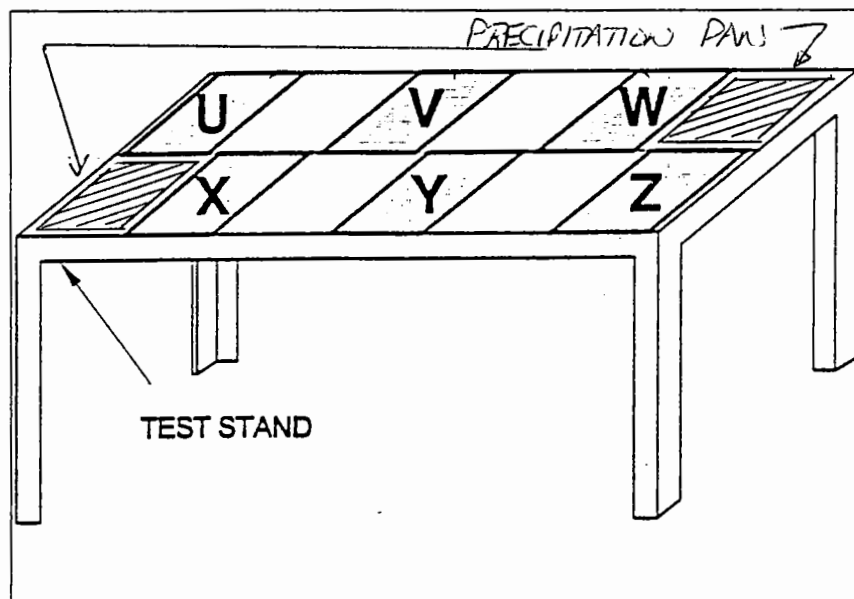

Figure 3: Location of Flat Plates on Test Stand Mount Frame.

A detailed illustration of a flat plate is given in Figure 4. Note the mount holes and the cross hair points. Each cross-hair point is identified using the following nomenclature: B1, B2, B3 : C1, C2, C3: D1, D2, D3 : E1, E2, E3 and F1, F2, F3. B1 is the upper left cross-hair point and F3 is the lower right hand cross-hair point.

5.2 Fluid Application Procedures

The FPD de-icing fluid is applied to each panel individually, commencing at the raised edge and working downward to the lower edge. Applying the fluid in

a flooding manner ensures that the plate is completely covered and all adhered precipitation is removed. The plates are de-iced in the following sequence:

1. Flat Plate U: de-iced with XL54 fluid obtained from de-icing truck;
2. Flat Plate X: de-iced with XL54 fluid obtained from de-icing truck;
3. Flat Plate V: de-iced with standard XL54 fluid (approximately 20.0°C). The fluid is poured on the plates from a hand-held container;
4. Flat Plate Y: de-iced with standard XL54 fluid (approximately 20.0°C). The fluid is poured on the plates from a hand-held container;
5. Flat Plate W: de-iced with XL54 fluid (approximately 20.0°C) mixed to a 10° buffer ³ and poured on the plates from a hand-held container; and
6. Flat Plate Z: de-iced with XL54 fluid (approximately 20.0°C) mixed to a 10° buffer and poured on the plates from a hand-held container.

5.3 Cross Hair Markings

Each flat plate test panel is marked with fifteen cross-hair points. Refer to Figure 4. These cross-hairs are used to help identify fluid failure. It may be necessary during the static tests to remark the cross-hairs.

5.4 Failure Identification

There are distinct definitions for test end conditions based upon precipitation type. Test end condition is defined as the time required for the FPD fluid to fail after the fluid has been appropriately applied to the flat plate. On each flat plate, the fifteen cross hairs represent the plate's surface. These fifteen sites are observed during the process of fluid failure are used to identify test end conditions. During falling snow precipitation conditions a test end condition is reached when: *The fluid can no longer absorb the precipitation on five of the fifteen cross hairs.*

During the conditions of freezing rain/drizzle/snow combinations a test end condition is reached when: *five(5) of the cross-hairs have been effected. When precipitation or frosting produces a loss of gloss (i.e a dulling of the surface reflectivity) or a change in colour (dye) to grey or greyish appearance at any five cross-hairs, or ice (or crusty snow) has formed on the cross-hair (look for ice crystals).*

³A 10° buffer de-icing fluid is that mixture which has a freeze point 10° below ambient. The de-icing fluid is diluted with water prior to each test evening and adjusted on-site before each test to account for temperature shifts.

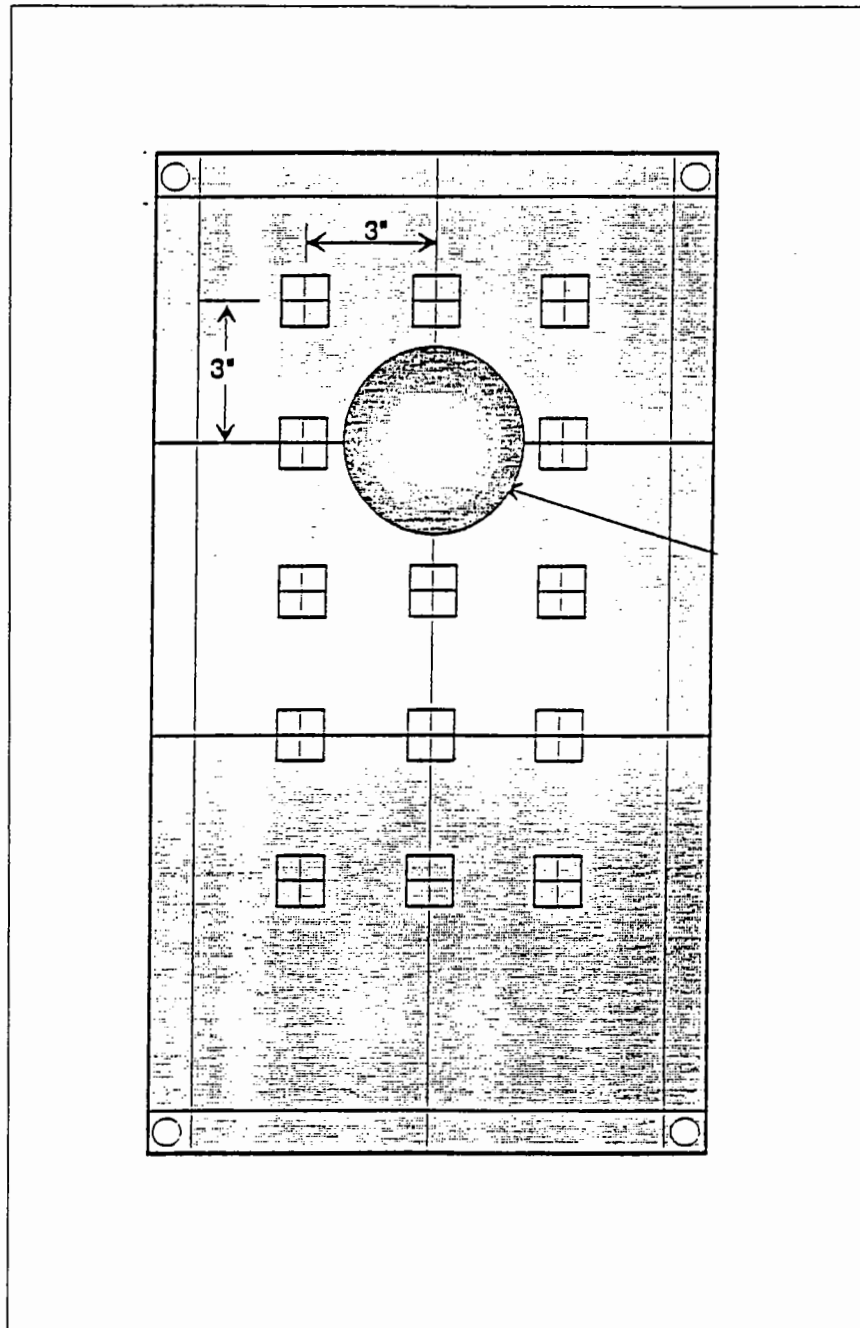

Figure 4: Flat Plate Illustration.

Observing the failure of the cross hairs is a subjective matter. Because of this, the following is very important:

1. Whenever possible, have the same individual make the call on cross hair failure.
2. Be consistent in the call of a failed cross hair.

5.5 Cleaning Procedures

Before the aircraft wing is de-iced, each flat plates must be cleaned. The prevailing precipitation will accumulate on the flat plates before and in between tests making it difficult for the standard XL54 and 10° buffer XL54 fluid to remove the precipitation layer. Excess fluid and precipitation will be pushed off with a squeegee. Even though precipitation conditions will prevail the flat plates will be as clean as possible under the circumstances.

5.6 Flat Plate FPD Fluid Preparation

The FPD fluid applied to flat plate sections W and Z must be mixed with water to provide a 10°C buffer zone. The percentage of XL54 mixed with water is dependent on the ambient temperature of the air. Table 3 describes the percent dilution of 100% concentrate XL54 to give the desired 10°C buffer.

Air Temperature (°C)	XL54	Refractometer Output (°F)
0.0	23%	14.0
-2.0	26%	10.4
-4.0	29%	6.8
-6.0	31%	3.2
-8.0	34%	-0.4
-10.0	36%	-4.0
-15.0	41%	-13.0
-20.0	46%	-22.0
-25.0	50%	-31.0
-30.0	54%	-40.0
-33.0	57% (*)	-45.4

Table 3: Glycol Concentration Based on 10°C Buffer.

The 57% diluted XL54 entry represents the standard concentration of this brand of Type I FPD fluid used to de-ice aircrafts. The Refractometer Output

column represents the scale reading which will be observed from the refractometer. Since the refractometer output is in °F and the ambient temperature is typically measured in °C, the conversion is provided. Note that the refractometer column incorporated the buffer.

5.7 Plate Pan Procedures

The precipitation plate pans are mounted on the flat plate stands (FPS). There are two required per FPS. Refer to Figure 3 for the precipitation plate pans mount locations. Before the precipitation plates pans are mounted they must pre-wetted. This involves pouring enough de-icing fluid into the precipitation plate pan to cover the bottom. Each pan is then weighed.

After all the flat plates on a particular FPS are flooded with FPD fluid the flat plate covers are removed and mounted on the FPS. Upon termination of the test both flat plate covers are placed back on their respective precipitation plate pans.

The precipitation plate pans must be removed from the FPS and the accumulated precipitation weighed. All contaminants on the outside of the precipitation plate pans must be removed. Excess water must be wiped off. At this point in time there should be no moisture on the outside of the precipitation plate pans. The precipitation plate pans can now be weighed.

Before returning the precipitation plate pans to the test site, the pans must be thoroughly dried, re-wetted and weighed.

6 Experiment Concerns

6.1 External Clothing Arrangements

It has been decided that all INSTRUMAR personnel will provide their own clothing. Because of the procedures implemented during the spraying of the aircraft and during the observation of the failing fluid, the possibility of contact with the fluid has been minimized. Contact with the XL54 fluid will be limited to ones outer boots. They should be at minimum rubber sole/ankle high foot wear. The only identified potential high risk area is the hand area. Hands should at all times be protected with the use of gloves. Therefore, each person who is exposed to the XL54 should take their own precautionary measures to ensure that they do not touch their hair, glasses, face, or other parts of their body with their gloves which may otherwise lead to external or internal exposure. An old pair of track pants worn outside of your pants or leggings would probably be the best solution to preventing XL54 from pant contact.

6.2 Safety

Safety has been discussed throughout this document. The issues are summarized from the following three headings:

1. Personnel Safety : Each person involved in the program should be aware of their responsibilities and are expected to conduct themselves in a professional manner. Walking toward the aircraft, moving the platforms, mounting the platforms and any other event occurring around the experiment site should be approached with safety in mind. Do not walk fast nor run on the tarmac. Always support yourself using the platform rails. These are a few cited examples. The important thing is to exercise safety
2. Aircraft Safety. Any equipment placed on the tarmac and especially close to the aircraft should be done such as to obviate potential problems. Except for the squeegee, equipment should never touch the aircraft or be placed in a position in which this could potentially occur.
3. Equipment Safety. Most of the equipment being used during the static tests have either been rented or they are on loan. INSTRUMAR is responsible for the return of these items in working condition. Please use the equipment as assigned.

6.3 General

1. Transportation: Each person is responsible for getting to St John's airport. Depending on the aircraft being tested the most appropriate parking lot will be identified. Any parking fees incurred during the test will be reimbursed. Keep your parking receipts. Please ensure that you park in a valid parking zone because it will be extremely difficult for airport personnel to get in touch with you once the testing commences.
2. During fluid applications all personnel not directly involved must be approximately 50 feet in front of the aircraft. This site on the tarmac is referred to as the *Front Neutral Zone*: see Figure 1. Because the aircraft will be facing the wind this location will prevent over spray from reaching the *Front Neutral Zone*. Once the aircraft fluid application is complete all personnel should proceed to their designated locations.
3. Health and Safety: FPD fluids are glycols and should not be directly handled. All personnel should familiarize themselves with Appendix B. The most important reminder is not to get the XL54 on your gloves. Once on your gloves the XL54 will inevitable find its way into your hair, on your clothes and most likely in your eyes.
4. The observation platforms and all support systems which may become slippery as a result of the fluid application should be positioned away from the aircraft during the application and repositioned after the application. They should be placed in the *Left Neutral Zone* or *Right Neutral Zone* depending on whether the equipment is on the left or right hand side of the plane.
5. What happens if there are two or more simultaneous calls to the Recorder? Typically the events will occur at around the same time. The Observer will continue to call the Recorder.
6. Fogging/misty glasses: This condition should be addressed if the precipitation on your glasses prevents you from observing required information. More importantly, this should be done to ensure personal safety.
7. Fluid Failure Identification: All possibly means of providing the Observers and Floating Coordinators with as much information and experience necessary to identify fluid failure is being dealt with. This will attempt to standardize the fluid failure calls.

A Static Test Forms

A.1 Floating Coordinator - ASTP_FCF

Form ASTP_FCF.APS

FLOATING COORDINATOR

APS Static Tests

IDENTIFICATION DETAILS			
Airport:	YUL YYZ YYT	Aircraft Type :	A320 DC-9 B-737 RJ BAe-146
Location of Test:	_____	Airline:	_____
Date:	_____	Plane/Fin ID #:	_____
Test ID:	_____	Fuel Load:	_____ lb / kg : Tmp: _____
Measurements By:	_____	Assisted By:	_____

FLUID APPLICATION DETAILS			
Type of Fluid:	_____	Fluid Temperature:	_____
Fluid Nozzle Type:	_____	Company:	_____

IDENTIFICATION DETAILS	
Driver:	_____
Fluid Application Person:	_____

RIGHT FLAT PLATE FLUID APPLICATION

Start of Fluid Gauge:	_____
End of Fluid Gauge:	_____

LEFT FLAT PLATE FLUID APPLICATION

Start of Fluid Gauge:	_____
End of Fluid Gauge:	_____

RIGHT WING FLUID APPLICATION

Start of Fluid Gauge:	_____
End of Fluid Gauge:	_____

LEFT WING FLUID APPLICATION

Start of Fluid Gauge:	_____
End of Fluid Gauge:	_____

COMMENTS:

NOTE: Fluid Application Driver must fill out the Fluid Application Details Section.

INSTRUMAR Limited

A.2 Floating Coordinator - ASTP_FCO

Form ASTP_FCO.APS

FLOATING COORDINATOR

APS Static Tests

IDENTIFICATION DETAILS	
Measurements By: _____	Assisted By: _____
Date: _____	Test ID: _____

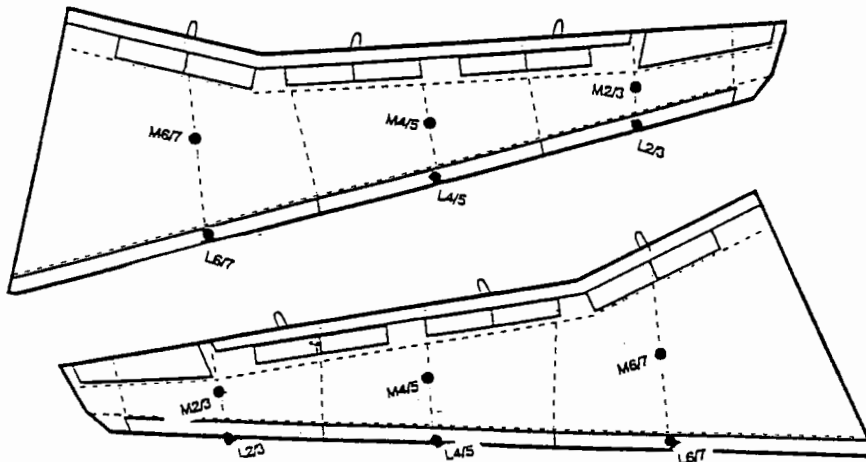

ENTER FLUID TYPE:						
TIME (min)	TEMPERATURE AT LOCATION (°C)					
	L6/7	M6/7	L4/5	M4/5	L2/3	M2/3
Before						
End						

ENTER FLUID TYPE:						
TIME (min)	TEMPERATURE AT LOCATION (°C)					
	L6/7	M6/7	L4/5	M4/5	L2/3	M2/3
Before						
End						

A.3 Observer (Left) - ASTP_OBW (A320)

Form ASTP_OBW.APS

OBSERVER

APS Static Test

WING SECTION

A320

IMPORTANT EVENTS EVENT/ID	TIME STAMP			Rep. Surface
	L	M	T	
First Failure				
10%				
25%				
50%				
75%				
100%				

COMMENTS:

Observer:

Assisted By:

Date:

Test ID:

Inner / Outer

INSTRUMAR Limited

NOTE: Call Recorder Upon Commencing Observation.

A.4 Observer (Right) - ASTP_OBW (A320)

APS Static Test

OBSERVER

Form ASTP_OBW.APS

WING SECTION		A320				Inner / Outer																																						
<p style="text-align: center;">T M L</p>	<table border="1" style="width: 100%; border-collapse: collapse;"> <thead> <tr> <th rowspan="2">IMPORTANT EVENTS EVENT/ID</th> <th colspan="3">TIME STAMP</th> <th rowspan="2">Rep. Surface</th> </tr> <tr> <th>L</th> <th>M</th> <th>T</th> </tr> </thead> <tbody> <tr> <td>First Failure</td> <td></td> <td></td> <td></td> <td></td> </tr> <tr> <td>10%</td> <td></td> <td></td> <td></td> <td></td> </tr> <tr> <td>25%</td> <td></td> <td></td> <td></td> <td></td> </tr> <tr> <td>50%</td> <td></td> <td></td> <td></td> <td></td> </tr> <tr> <td>75%</td> <td></td> <td></td> <td></td> <td></td> </tr> <tr> <td>100%</td> <td></td> <td></td> <td></td> <td></td> </tr> </tbody> </table>	IMPORTANT EVENTS EVENT/ID	TIME STAMP			Rep. Surface	L	M	T	First Failure					10%					25%					50%					75%					100%					<p>COMMENTS:</p>	<p>Observer:</p>	<p>Assisted By:</p>	<p>Date:</p>	<p>Test ID:</p>
IMPORTANT EVENTS EVENT/ID	TIME STAMP			Rep. Surface																																								
	L	M	T																																									
First Failure																																												
10%																																												
25%																																												
50%																																												
75%																																												
100%																																												

INSTRUMAR Limited

NOTE: Call Recorder Upon Commencing Observation.

A.5 Observer (Left) - ASTP_OBW (DC-9)

Form ASTP_OBW.APS **OBSERVER** APS Static Test

DC-9 Series 30

WING SECTION

IMPORTANT EVENTS EVENT/ID	TIME STAMP			Rep. Surface
	L	M	T	
First Failure				
10%				
25%				
50%				
75%				
100%				

COMMENTS:

Observer: _____ Assisted By: _____ Date: _____ Test ID: _____ Inner / Outer

INSTRUMAR Limited

NOTE: Call Recorder Upon Commencing Observation.

A.6 Observer (Right) - ASTP_OBW (DC-9)

Form ASTP_OBW.APS

OBSERVER

APS Static Test

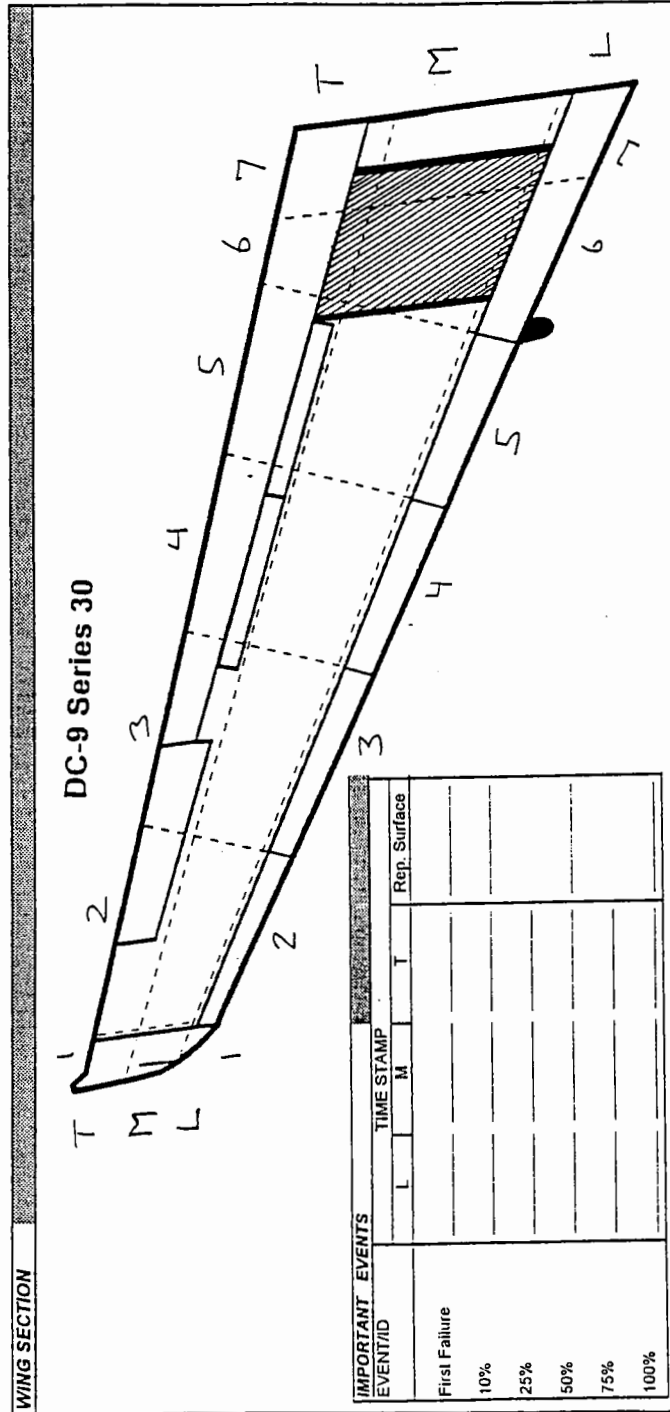

COMMENTS:

Observer: _____ Assisted By: _____ Date: _____ Test ID: _____ Inner / Outer _____

INSTRUMAR Limited

NOTE: Call Recorder Upon Commencing Observation.

A.7 Observer (Left) - ASTP_OBW (B-737)

APS Static Test

OBSERVER

Form ASTP_OBW.APS

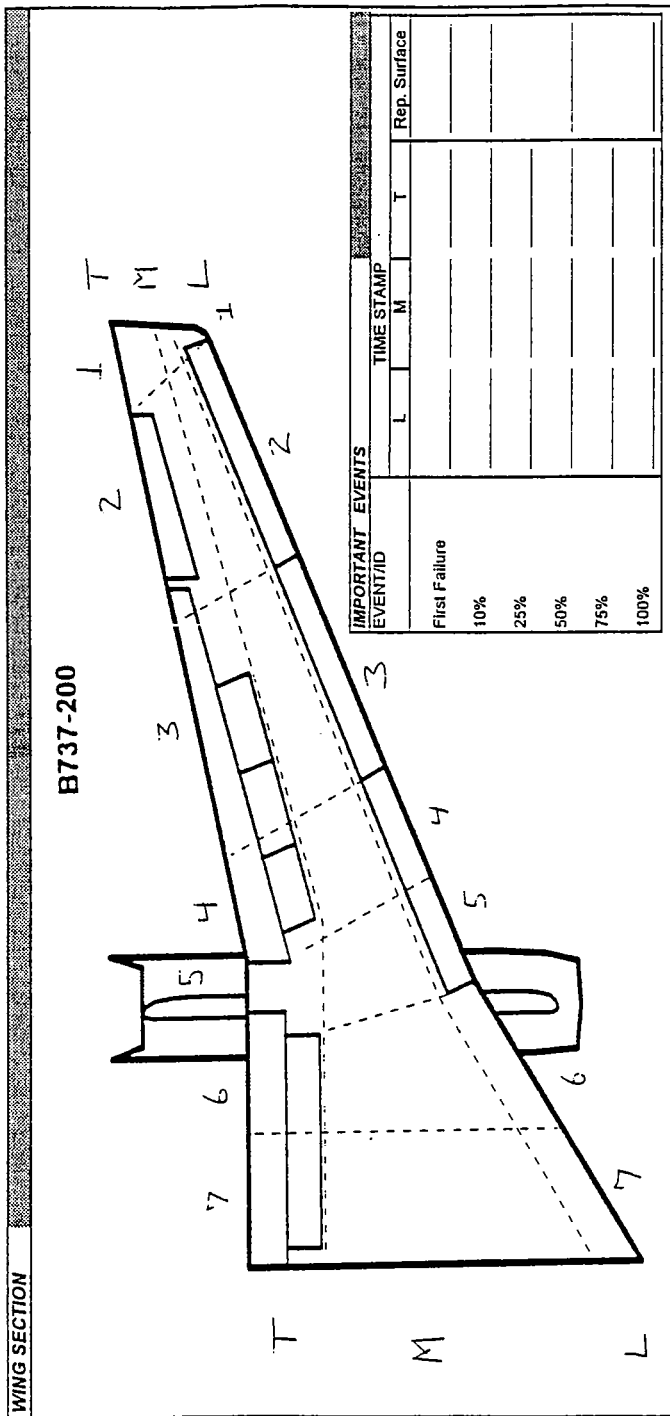

COMMENTS:

Observer: _____ Assisted By: _____ Date: _____ Test ID: _____ Inner / Outer _____

INSTRUMAR Limited

NOTE: Call Recorder Upon Commencing Observation.

A.8 Observer (Right) - ASTP_OBW (B-737)

APS Static Test

OBSERVER

Form ASTP_OBW.APS

WING SECTION	B737-200			Observer:	Assisted By:	Date:	Test ID:	Inner / Outer																																						
	<table border="1" style="width: 100%; border-collapse: collapse;"> <thead> <tr> <th rowspan="2">IMPORTANT_EVENTS EVENT/ID</th> <th colspan="3">TIME STAMP</th> <th rowspan="2">Rep. Surface</th> </tr> <tr> <th>L</th> <th>M</th> <th>T</th> </tr> </thead> <tbody> <tr> <td>First Failure</td> <td></td> <td></td> <td></td> <td></td> </tr> <tr> <td>10%</td> <td></td> <td></td> <td></td> <td></td> </tr> <tr> <td>25%</td> <td></td> <td></td> <td></td> <td></td> </tr> <tr> <td>50%</td> <td></td> <td></td> <td></td> <td></td> </tr> <tr> <td>75%</td> <td></td> <td></td> <td></td> <td></td> </tr> <tr> <td>100%</td> <td></td> <td></td> <td></td> <td></td> </tr> </tbody> </table>			IMPORTANT_EVENTS EVENT/ID	TIME STAMP			Rep. Surface	L	M	T	First Failure					10%					25%					50%					75%					100%									
IMPORTANT_EVENTS EVENT/ID	TIME STAMP				Rep. Surface																																									
	L	M	T																																											
First Failure																																														
10%																																														
25%																																														
50%																																														
75%																																														
100%																																														
<p>COMMENTS:</p>																																														

INSTRUMAR Limited

NOTE: Call Recorder Upon Commencing Observation.

A.9 Observer (Left) - ASTP_OBW (RJ)

APS Static Test

OBSERVER

Form ASTP_OBW/APS

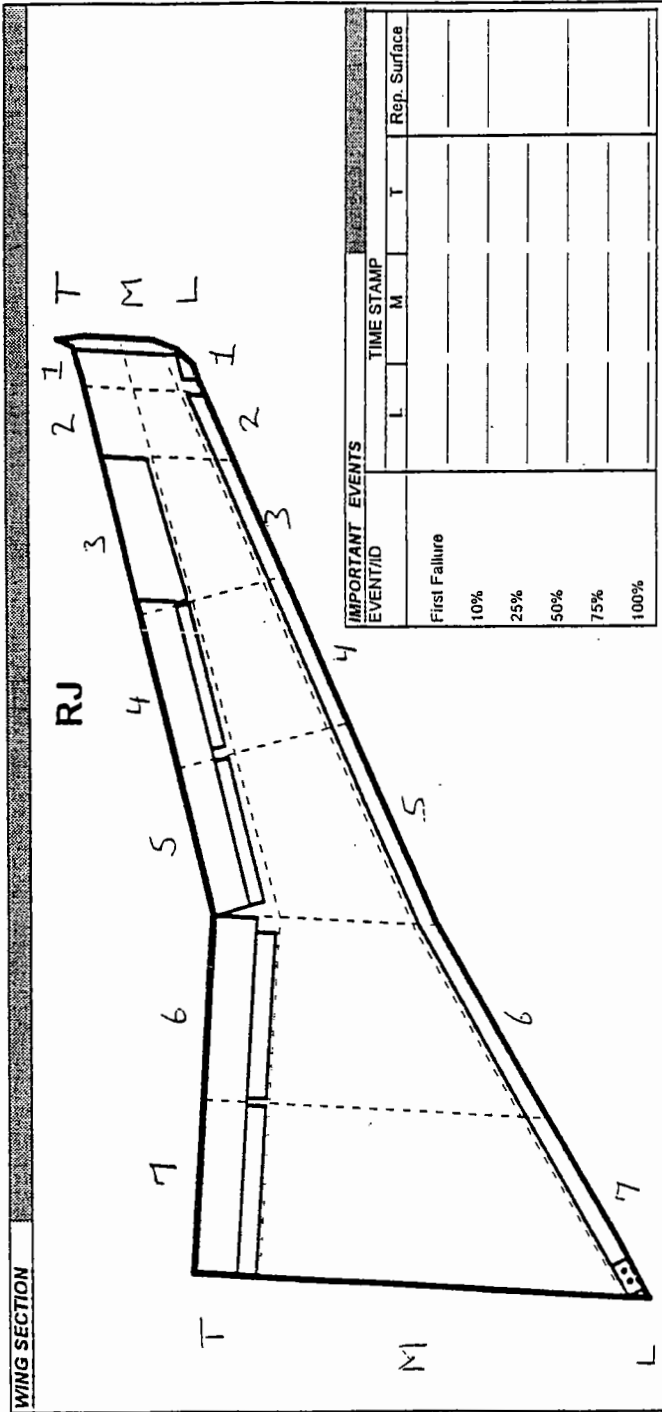

COMMENTS:

Observer: _____

Assisted By: _____

Date: _____

Test ID: _____

Inner / Outer

INSTRUMAR Limited

NOTE: Call Recorder Upon Commencing Observation.

A.10 Observer (Right) - ASTP_OBW (RJ)

Form ASTP_OBW.APS	OBSERVER	APS Static Test																																						
WING SECTION																																								
IMPORTANT EVENTS	<table border="1" style="width: 100%; border-collapse: collapse;"> <thead> <tr> <th rowspan="2">EVENT/ID</th> <th colspan="3">TIME STAMP</th> <th rowspan="2">Rep. Surface</th> </tr> <tr> <th>L</th> <th>M</th> <th>T</th> </tr> </thead> <tbody> <tr> <td>First Failure</td> <td></td> <td></td> <td></td> <td></td> </tr> <tr> <td>10%</td> <td></td> <td></td> <td></td> <td></td> </tr> <tr> <td>25%</td> <td></td> <td></td> <td></td> <td></td> </tr> <tr> <td>50%</td> <td></td> <td></td> <td></td> <td></td> </tr> <tr> <td>75%</td> <td></td> <td></td> <td></td> <td></td> </tr> <tr> <td>100%</td> <td></td> <td></td> <td></td> <td></td> </tr> </tbody> </table>		EVENT/ID	TIME STAMP			Rep. Surface	L	M	T	First Failure					10%					25%					50%					75%					100%				
EVENT/ID	TIME STAMP			Rep. Surface																																				
	L	M	T																																					
First Failure																																								
10%																																								
25%																																								
50%																																								
75%																																								
100%																																								
COMMENTS:	<div style="border: 1px solid black; height: 40px; width: 100%;"></div>																																							
Observer:	Assisted By:	Date:																																						
	Test ID:	Inner / Outer																																						

INSTRUMAR Limited

NOTE: Call Recorder Upon Commencing Observation.

A.11 Observer (Left) - ASTP_OBW (BAe-146)

Form ASTP_OBW.APS APS Static Test

OBSERVER

WING SECTION	IMPORTANT EVENTS			Rep. Surface
	EVENT/ID	L	M	
First Failure				
10%				
25%				
50%				
75%				
100%				

COMMENTS:

Observer: _____ Assisted By: _____ Date: _____ Test ID: _____ Inner / Outer _____

INSTRUMAR Limited

NOTE: Call Recorder Upon Commencing Observation.

A.12 Observer (Right) - ASTP_OBW (BAe-146)

APS Static Test

OBSERVER

Form ASTP_OBW.APS

WING SECTION		TIME STAMP			Rep. Surface
IMPORTANT EVENTS	EVENT/ID	L	M	T	
First Failure					
10%					
25%					
50%					
75%					
100%					

COMMENTS:

Observer:	Assisted By:	Date:	Test ID:	Inner / Outer
-----------	--------------	-------	----------	---------------

NOTE: Call Recorder Upon Commencing Observation.

INSTRUMAR Limited

A.13 Flat Plate Observer - ASTP_FPO

Form ASTP_FPO.APS

FLAT PLATE OBSERVER

APS Static Test

	U	V	W																																																
Fluid App. End Time:	Fluid Temp(U and X):	Fluid Name: <table border="1" style="width: 100%; border-collapse: collapse;"> <tr><td style="width: 25%;"></td><td style="width: 25%;"></td><td style="width: 25%;"></td><td style="width: 25%;"></td></tr> <tr><td>B1</td><td>B2</td><td>B3</td><td></td></tr> <tr><td>C1</td><td>C2</td><td>C3</td><td></td></tr> <tr><td>D1</td><td>D2</td><td>D3</td><td></td></tr> <tr><td>E1</td><td>E2</td><td>E3</td><td></td></tr> <tr><td>F1</td><td>F2</td><td>F3</td><td></td></tr> </table>					B1	B2	B3		C1	C2	C3		D1	D2	D3		E1	E2	E3		F1	F2	F3		Fluid Name: <table border="1" style="width: 100%; border-collapse: collapse;"> <tr><td style="width: 25%;"></td><td style="width: 25%;"></td><td style="width: 25%;"></td><td style="width: 25%;"></td></tr> <tr><td>B1</td><td>B2</td><td>B3</td><td></td></tr> <tr><td>C1</td><td>C2</td><td>C3</td><td></td></tr> <tr><td>D1</td><td>D2</td><td>D3</td><td></td></tr> <tr><td>E1</td><td>E2</td><td>E3</td><td></td></tr> <tr><td>F1</td><td>F2</td><td>F3</td><td></td></tr> </table>					B1	B2	B3		C1	C2	C3		D1	D2	D3		E1	E2	E3		F1	F2	F3	
B1	B2	B3																																																	
C1	C2	C3																																																	
D1	D2	D3																																																	
E1	E2	E3																																																	
F1	F2	F3																																																	
B1	B2	B3																																																	
C1	C2	C3																																																	
D1	D2	D3																																																	
E1	E2	E3																																																	
F1	F2	F3																																																	
Test Start Time:	Test End Time:	Fluid Name: <table border="1" style="width: 100%; border-collapse: collapse;"> <tr><td style="width: 25%;"></td><td style="width: 25%;"></td><td style="width: 25%;"></td><td style="width: 25%;"></td></tr> <tr><td>B1</td><td>B2</td><td>B3</td><td></td></tr> <tr><td>C1</td><td>C2</td><td>C3</td><td></td></tr> <tr><td>D1</td><td>D2</td><td>D3</td><td></td></tr> <tr><td>E1</td><td>E2</td><td>E3</td><td></td></tr> <tr><td>F1</td><td>F2</td><td>F3</td><td></td></tr> </table>					B1	B2	B3		C1	C2	C3		D1	D2	D3		E1	E2	E3		F1	F2	F3		Fluid Name: <table border="1" style="width: 100%; border-collapse: collapse;"> <tr><td style="width: 25%;"></td><td style="width: 25%;"></td><td style="width: 25%;"></td><td style="width: 25%;"></td></tr> <tr><td>B1</td><td>B2</td><td>B3</td><td></td></tr> <tr><td>C1</td><td>C2</td><td>C3</td><td></td></tr> <tr><td>D1</td><td>D2</td><td>D3</td><td></td></tr> <tr><td>E1</td><td>E2</td><td>E3</td><td></td></tr> <tr><td>F1</td><td>F2</td><td>F3</td><td></td></tr> </table>					B1	B2	B3		C1	C2	C3		D1	D2	D3		E1	E2	E3		F1	F2	F3	
B1	B2	B3																																																	
C1	C2	C3																																																	
D1	D2	D3																																																	
E1	E2	E3																																																	
F1	F2	F3																																																	
B1	B2	B3																																																	
C1	C2	C3																																																	
D1	D2	D3																																																	
E1	E2	E3																																																	
F1	F2	F3																																																	
		Failure Time:	Failure Time:																																																

INSTRUMAR Limited

NOTE: 1) Cover Precipitation Plate Pant(s) upon termination of test.
 2) Transfer information to Form ASTP_FPI.

A.14 Flat Plate Observer - ASTP_FPI

TABLE I
DE/ANTI-ICING DATA FORM

VERSION 2.2 Winter 94/95

REMEMBER TO SYNCHRONIZE TIME
LOCATION: _____

RUN NUMBER: _____ STAND #: _____ CIRCLE SENSOR PLATE: u v w x y z
Time After Fluid Applied to Plates U and X: _____ am / pm _____ SENSOR NAME: _____

RVSJ Series #: _____ Frame #: _____

COLLECTION PAN: PAN # _____ PAN # _____
Before After Before After

Weight of Pan (g) _____

Collection Time (min) _____

DIRECTION OF STAND: _____

CONTROL PLATE COMMENTS: _____

PRECIP: ZR ZL S SW IP IC BS SP ++ + - - -

SNOW/RAIN CATEGORIES (use velvet & classification): _____

OTHER COMMENTS (Fluid Batch, etc): _____

FAILURES CALLED BY: _____

HAND WRITTEN BY: _____

ASSISTED BY: _____

*TIME (After Fluid Application) TO FAILURE FOR INDIVIDUAL CROSSHAIRS (MINUTES)

Time of Fluid Application: _____ min (V & Y) _____ min (W & Z)

	Plate U	Plate V	Plate W
FLUID NAME			
B1 B2 B3			
C1 C2 C3			
D1 D2 D3			
E1 E2 E3			
F1 F2 F3			
TIME TO FIRST PLATE FAILURE WITHIN WORK AREA	1st <input type="text"/> Full <input type="text"/>	1st <input type="text"/> Full <input type="text"/>	1st <input type="text"/> Full <input type="text"/>
TIME OF SLUSH FORMATION ON SENSOR HEAD	1st <input type="text"/> Full <input type="text"/>	1st <input type="text"/> Full <input type="text"/>	1st <input type="text"/> Full <input type="text"/>

	Plate X	Plate Y	Plate Z
FLUID NAME			
B1 B2 B3			
C1 C2 C3			
D1 D2 D3			
E1 E2 E3			
F1 F2 F3			
TIME TO FIRST PLATE FAILURE WITHIN WORK AREA	1st <input type="text"/> Full <input type="text"/>	1st <input type="text"/> Full <input type="text"/>	1st <input type="text"/> Full <input type="text"/>
TIME OF SLUSH FORMATION ON SENSOR HEAD	1st <input type="text"/> Full <input type="text"/>	1st <input type="text"/> Full <input type="text"/>	1st <input type="text"/> Full <input type="text"/>

FORM 2-11-8 Printed 11/95

A.15 Recorder - ASTP_REC

RECORDER

APS Static Tests

Form ASTP_REC.APS

IDENTIFICATION DETAILS		Left Wing Section		Right Wing Section	
Recorder :					
Assisted By:					
Date:					
Test ID:					
Fluid Application Start Time:		Fluid Application End Time(**):		Termination of test:	

LEFT OUTER WING		LEFT INNER WING		RIGHT INNER WING		RIGHT OUTER WING	
Observer:		Observer:		Observer:		Observer:	
Obs. Start Time:		Obs. Start Time:		Obs. Start Time:		Obs. Start Time:	

IMPORTANT EVENTS		TIME STAMP		EVENT/ID		TIME STAMP			
EVENT/ID	L	T	Time	L	T	Time	L	T	Time
First Failure									
1 Sq. Foot				First Failure					
25%				1 Sq. Foot					
50%				25%					
75%				50%					
100%				75%					
				100%					
First Failure				First Failure					
10% Rep.				10% Rep.					
50% Rep.				50% Rep.					
100% Rep.				100% Rep.					

C/FIMS		L Wing		R Wing	
First Failure:					
100 percent:					

COMMENTS (*) Communicate this to Cockpit Recorder. (**) PC Start Time Stamp. Required only with C/FIMS.

INSTRUMAR Limited

NOTE: Establish and confirm communication link between all team members upon arrival in aircraft.

A.16 Cockpit Recorder - ASTP_CPR

Form ASTP_CPR.APS

COCKPIT RECORDER

APS Static Tests

IDENTIFICATION DETAILS				
Recorder:	_____	Assisted By: _____	Date _____	Test ID: _____

PRE-FLUID APPLICATION							
Location	Time Stamp	C/FIMS Sensor Output					Temp
		Snow	Ice	Clean	Fluid	Other	
Wing Left:	_____	_____	_____	_____	_____	_____	_____
	_____	_____	_____	_____	_____	_____	_____
Wing Right:	_____	_____	_____	_____	_____	_____	_____
	_____	_____	_____	_____	_____	_____	_____
Tail Left:	_____	_____	_____	_____	_____	_____	_____
	_____	_____	_____	_____	_____	_____	_____
Tail Right:	_____	_____	_____	_____	_____	_____	_____
	_____	_____	_____	_____	_____	_____	_____

POST-FLUID APPLICATION (*)							
Location	Time Stamp	C/FIMS Sensor Output					Temp
		Snow	Ice	Clean	Fluid	Other	
Wing Left:	_____	_____	_____	_____	_____	_____	_____
	_____	_____	_____	_____	_____	_____	_____
Wing Right:	_____	_____	_____	_____	_____	_____	_____
	_____	_____	_____	_____	_____	_____	_____
Tail Left:	_____	_____	_____	_____	_____	_____	_____
	_____	_____	_____	_____	_____	_____	_____
Tail Right:	_____	_____	_____	_____	_____	_____	_____
	_____	_____	_____	_____	_____	_____	_____

100 PERCENT COVERED (*)							
C/FIMS Installation	Time Stamp	C/FIMS Sensor Output					Temp
		Snow	Ice	Clean	Fluid	Other	
Wing Left:	_____	_____	_____	_____	_____	_____	_____
	_____	_____	_____	_____	_____	_____	_____
Wing Right:	_____	_____	_____	_____	_____	_____	_____
	_____	_____	_____	_____	_____	_____	_____
Tail Left:	_____	_____	_____	_____	_____	_____	_____
	_____	_____	_____	_____	_____	_____	_____
Tail Right:	_____	_____	_____	_____	_____	_____	_____
	_____	_____	_____	_____	_____	_____	_____

COMMENTS:	
1)	PC Start Time Stamp: _____ (Beginning of Fluid Application)
2)	(*) Record information when instructed by cabin Recorder.

INSTRUMAR Limited

APPENDIX C
DETAILED AIRCRAFT VS FLAT PLATE TEST RESULTS

DETAILED AIRCRAFT VS FLAT PLATE TEST RESULTS

This Appendix presents detailed results in bar chart format of all tests performed by both APS and Instrumar. Although the presentation is somewhat different, both APS and Instrumar charts indicate test conditions relative to each test and define specific bar chart legends.

The following comments regarding chart presentation, apply to Instrumar bar charts only:

1. VOID - this implies that the data point is required, however, due to circumstances beyond the observer's control, the observation was not obtained;
2. NIC - not in contract: this observation was not a requirement of the current procedure under which the test was conducted;
3. DNF - did not fail: this implies that the observation was required and made, but that failure did not occur;
4. N/A - not applicable: this only occurred during test T10 and T11 because the BAe-146 carrier, which was only used during this test evening, did not have a representative surface. Refer to Figures 46 to 49.

The above codes are contained in various tables throughout the report. Most of the bar charts follow the outline described above. However, in some instances, certain bar charts required further explanation:

Instrumar Tests:

1. Tests T10 - Figure 47: the right inner wing section entries consist of voids. During the particular test evening, the de-icing truck could not remove the ice from the BAe-146 inner wing section. The truck was heavily covered with ice and the boom hydraulics were not functioning properly.
2. Tests T10 and T11: tests T10 and T11 were conducted on a BAe-146 carrier. There is no representative surface on this aircraft type. Hence, the representative surface failure observations are omitted in Figure 46 through Figure 49. The omission is identified with a "N/A" (not applicable).
3. 10° buffer: the 10° buffer is omitted from tests T3 to T11. The 10° buffer is included in tests T1, T2, T12, T13, T14.
4. Middle Wing Section: failure calls on the middle wing section are omitted in tests T1 to T9. This omission is identified with "NIC". The failure calls are included in tests T10 to T14. This was a result of contractual changes.
5. Flat Plate Installed C/FIMS: during tests T10 to T14, a C/FIMS sensor was installed in one of the flat plates. The flat plate used was location V. This alteration was a result of contractual changes.

See also paragraph 2.4 for further notes on data presentation.

TEST L1
FULL-SCALE AIRCRAFT TEST @ YUL
DC-9, STARBOARD WING
FEB 24/95, RUN #1

Start Time = 12:06 am

Conditions:
 Ambient temp = 0°C
 Wind Speed = 2 kph
 Rate of Precipitation = 11 g/dm²/hr

Aircraft Data:
 1st Application= XL54 30/70 (Type I)
 2nd Application= XL54 (Type I)
 Fuel Load = 3,300 lb
 A/C Direction = 105°

Flat Plate Data:
 Fluid Type = XL54 (Type I)
 C/FIMS Location = Plate V
 Stand Direction = 82°

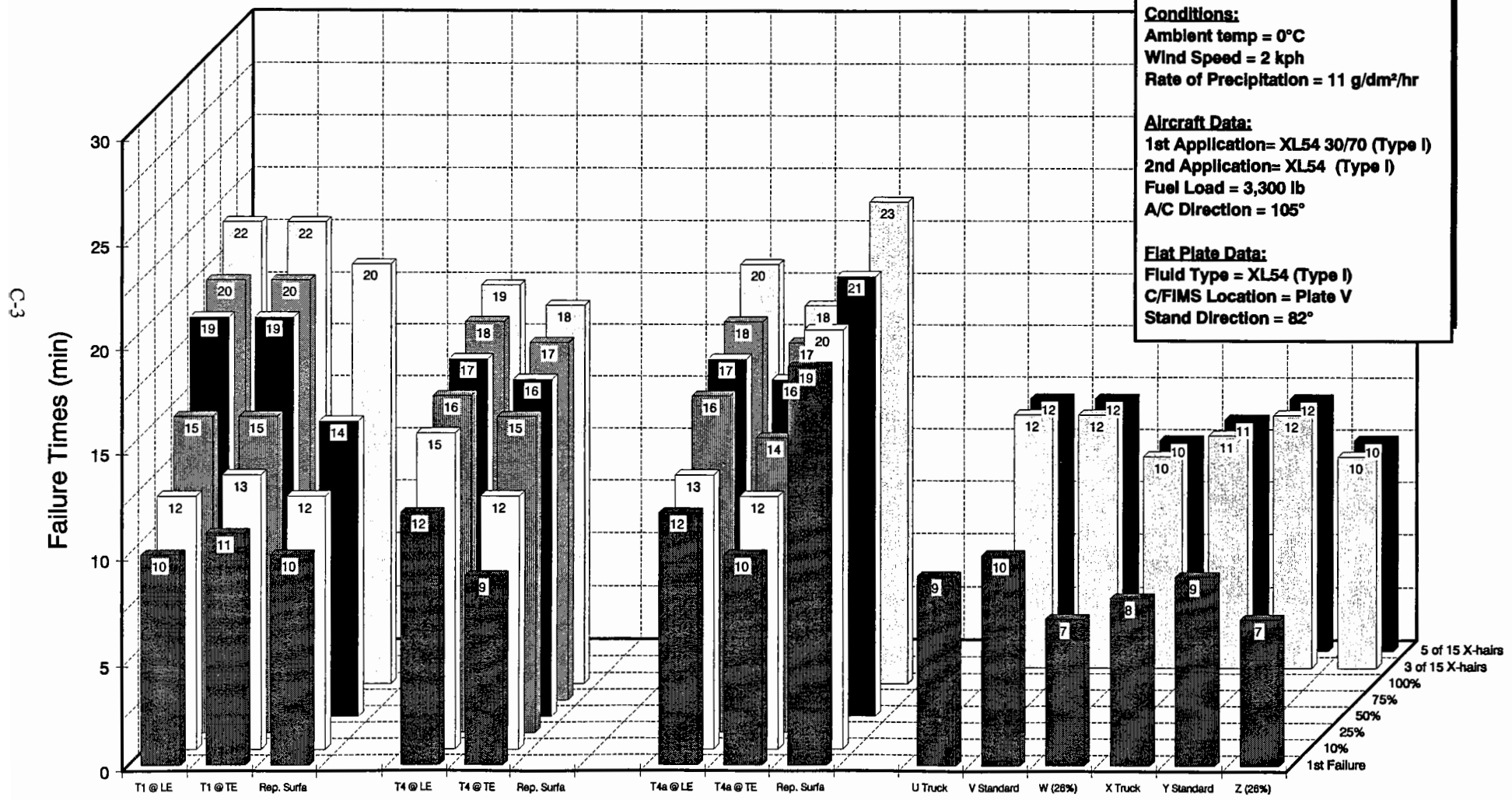

TEST L3

FULL-SCALE AIRCRAFT TEST @ YUL

DC-9, PORT WING

MAR 06/95, RUN #3

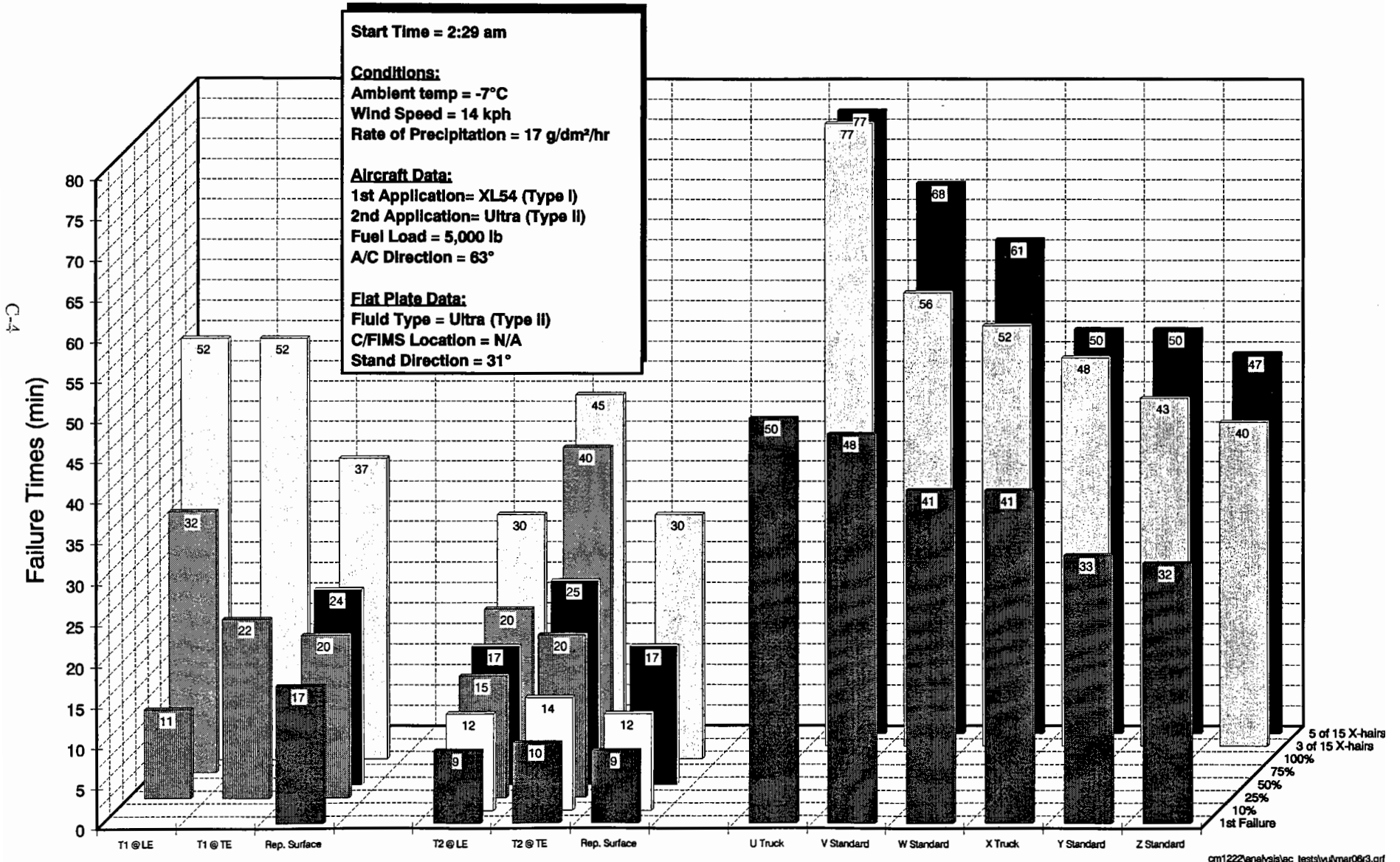

TEST L4
FULL-SCALE AIRCRAFT TEST @ YUL
DC-9, STARBOARD WING
MAR 06/95, RUN #4

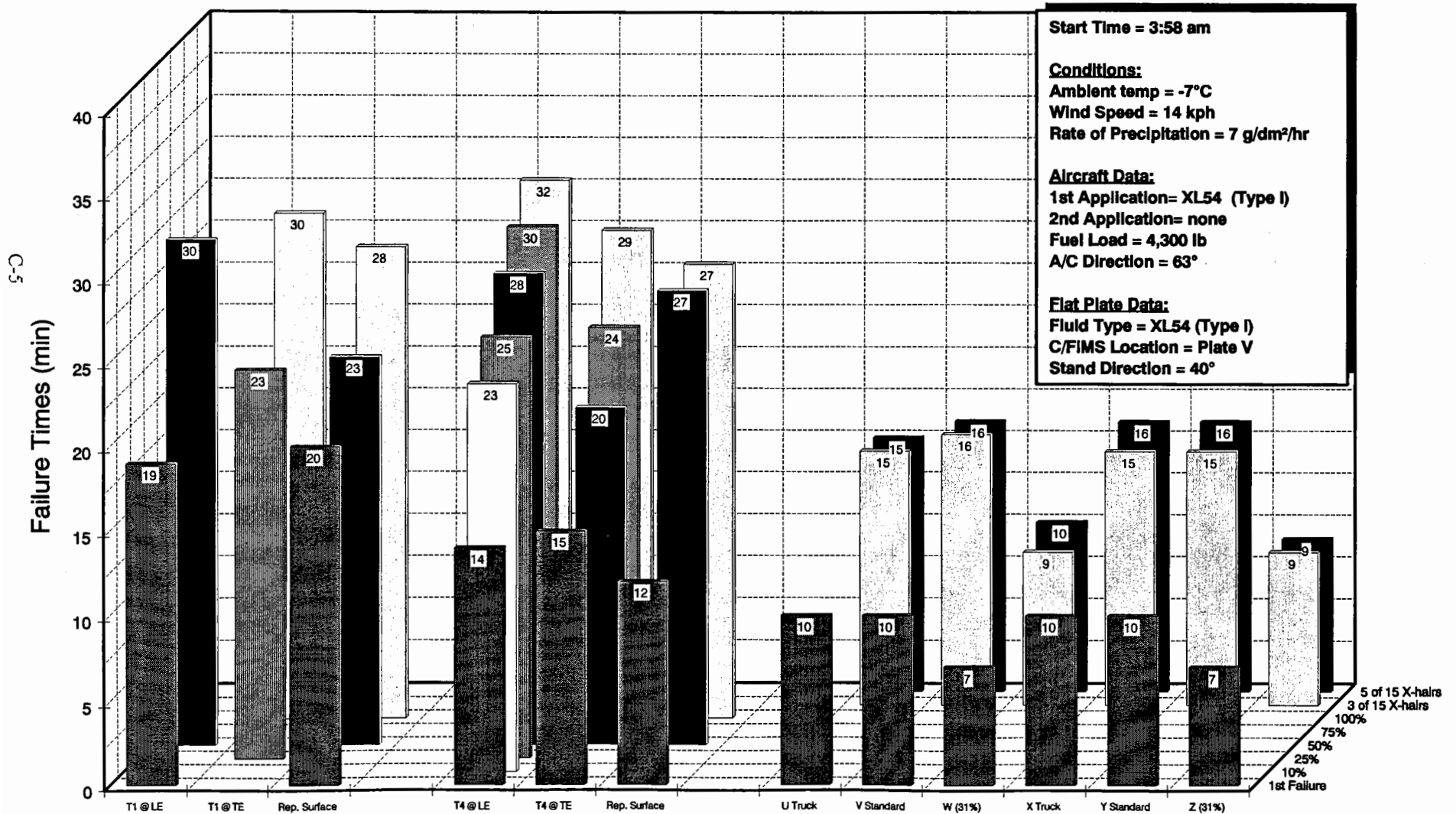

TEST L5

FULL-SCALE AIRCRAFT TEST @ YUL

DC-9, PORT WING

MAR 06/95, RUN #5

Start Time = 4:48 am

Conditions:
 Ambient temp = -7°C
 Wind Speed = 10 kph
 Rate of Precipitation = 6 g/dm²/hr

Aircraft Data:
 1st Application= XL54 (Type I)
 2nd Application= none
 Fuel Load = 4,300 lb
 A/C Direction = 63°

Flat Plate Data:
 Fluid Type = XL54 (Type I)
 C/FIMS Location = N/A
 Stand Direction = 31°

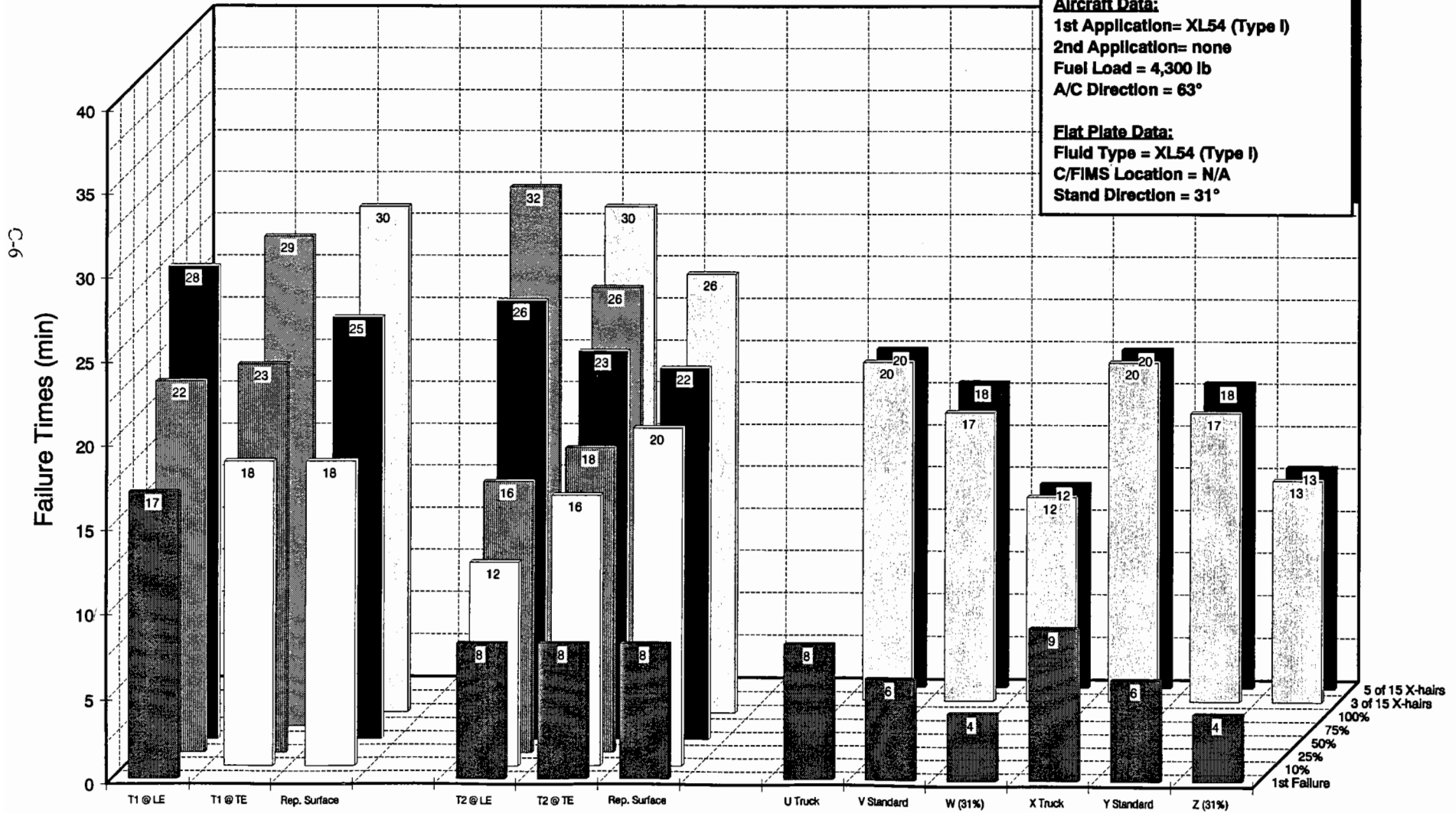

TEST L7

FULL-SCALE AIRCRAFT TEST @ YUL

DC-9, PORT WING

MAR 09/95, RUN #2

Start Time = 1:52 am

Conditions:
 Ambient temp = -7°C
 Wind Speed = 8 kph
 Rate of Precipitation = 9 g/dm²/hr

Aircraft Data:
 1st Application= XL54 (Type I)
 2nd Application= Ultra (Type II)
 Fuel Load = 5,300 lb
 A/C Direction = 17°

Flat Plate Data:
 Fluid Type = Ultra (Type II)
 C/FIMS Location = N/A
 Stand Direction = 21°

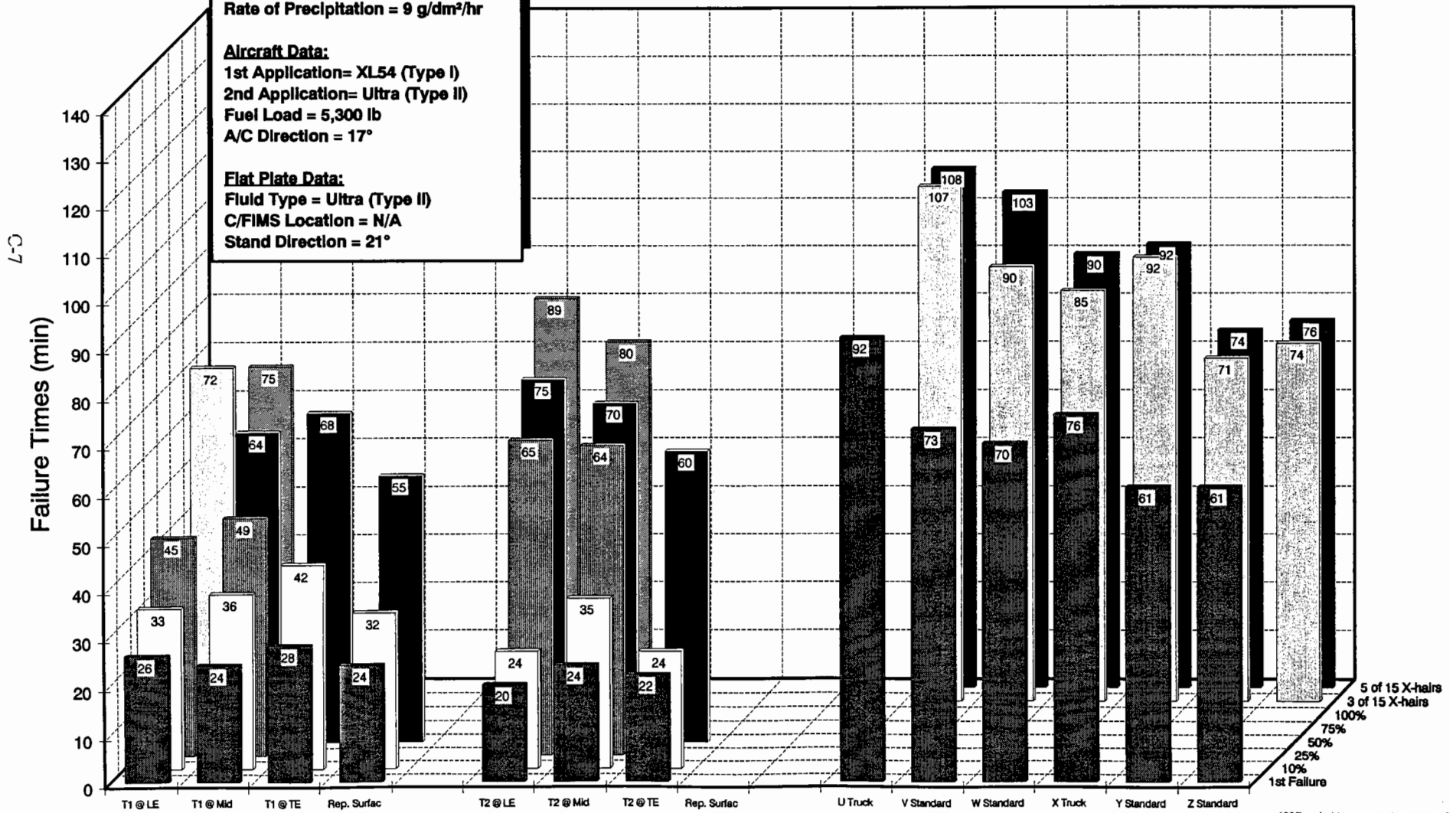

5 of 15 X-hairs
 3 of 15 X-hairs
 100%
 75%
 50%
 25%
 10%
 1st Failure

TEST L8

FULL-SCALE AIRCRAFT TEST @ YUL

DC-9, STARBOARD WING

MAR 09/95, RUN #3

Start Time = 2:35 am

Conditions:
 Ambient temp = -7°C
 Wind Speed = 12 kph
 Rate of Precipitation = 9 g/dm²/hr

Aircraft Data:
 1st Application= XL54 (Type I)
 2nd Application= none
 Fuel Load = 5,100 lb
 A/C Direction = 17°

Flat Plate Data:
 Fluid Type = XL54 (Type I)
 C/FIMS Location = V
 Stand Direction = 360°

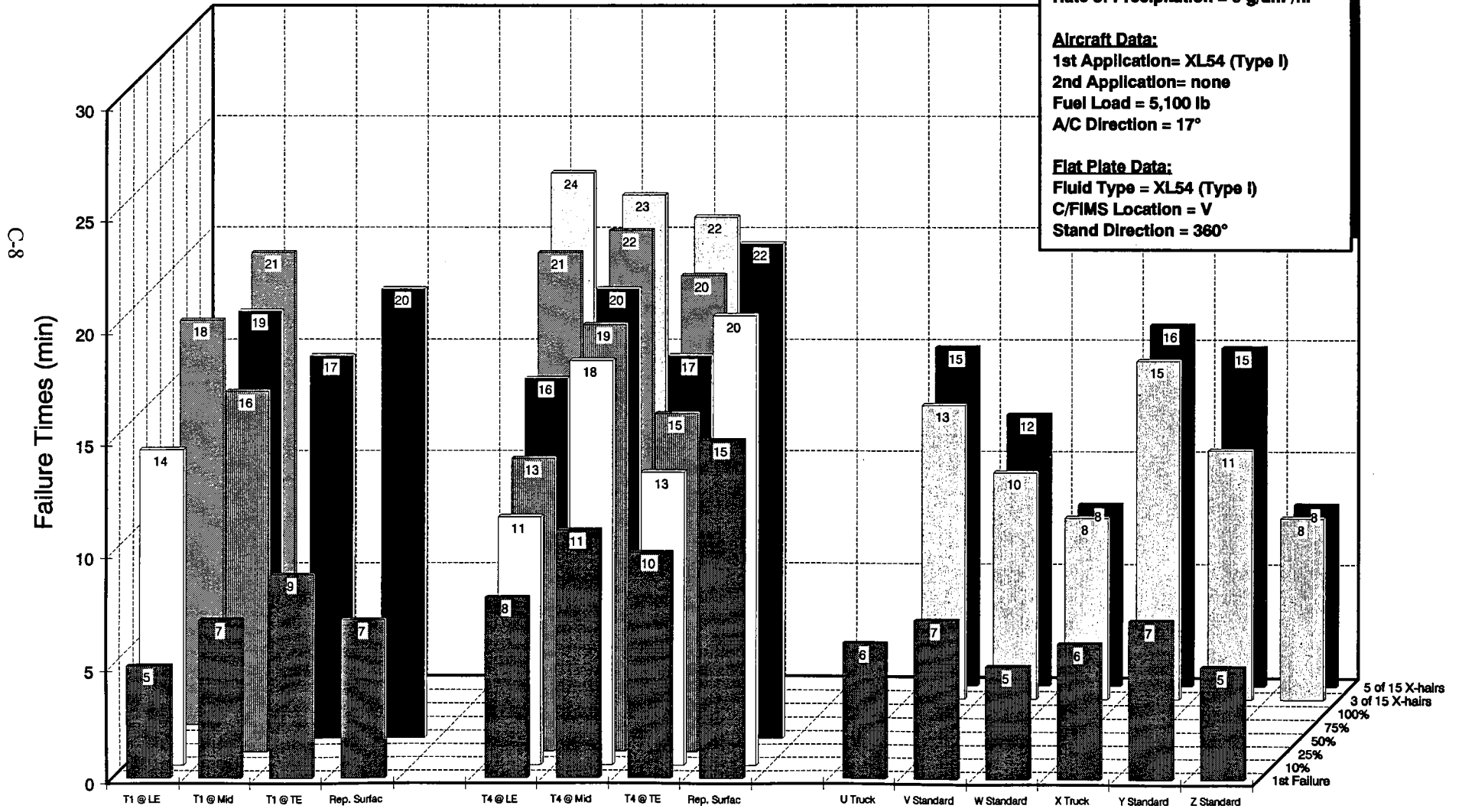

TEST L9
FULL-SCALE AIRCRAFT TEST @ YUL
DC-9, STARBOARD WING
MAR 09/95, RUN #4

Start Time = 3:43 am

Conditions:
 Ambient temp = -7°C
 Wind Speed = 9 kph
 Rate of Precipitation = 6 g/dm²/hr

Aircraft Data:
 1st Application= XL54 (Type I)
 2nd Application= none
 Fuel Load = 5,100 lb
 A/C Direction = 17°

Flat Plate Data:
 Fluid Type = XL54 (Type I)
 C/FIMS Location = V
 Stand Direction = 318°

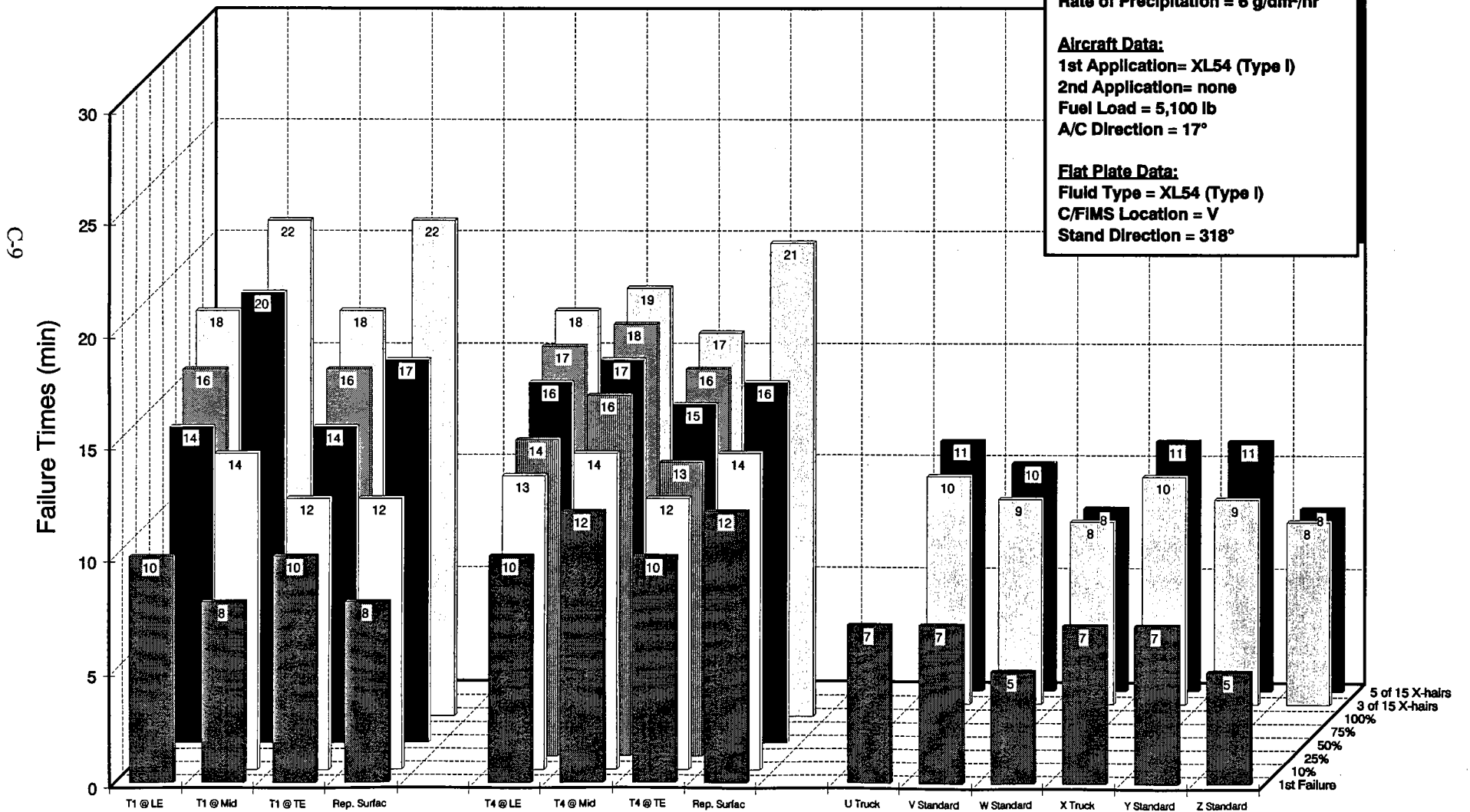

TEST Z1
FULL-SCALE AIRCRAFT TEST @ YYZ
B-737, STARBOARD WING
FEB 21/95, RUN #1

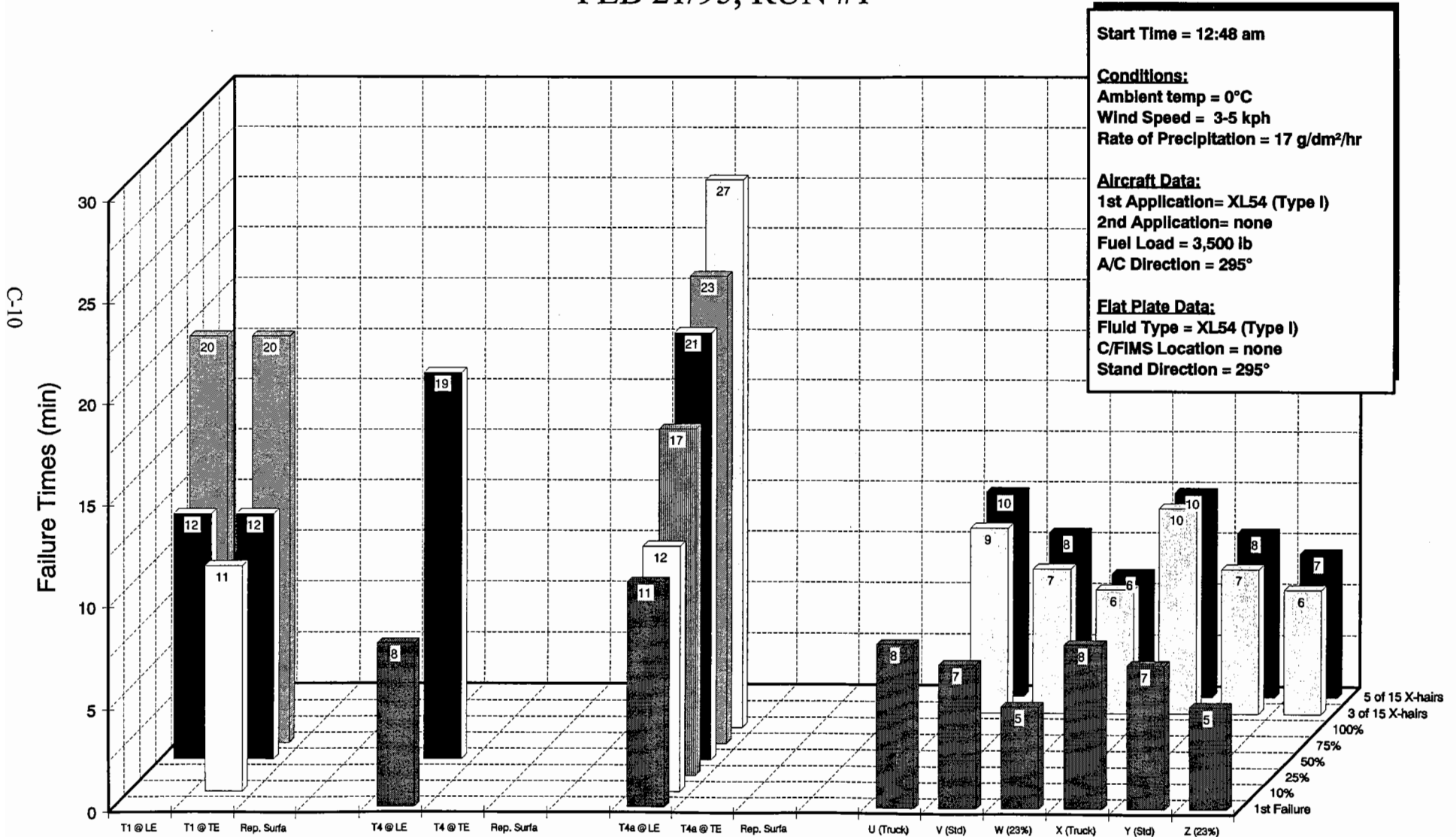

TEST Z2
FULL-SCALE AIRCRAFT TEST @ YYZ
B-737, STARBOARD WING
FEB 21/95, RUN #2

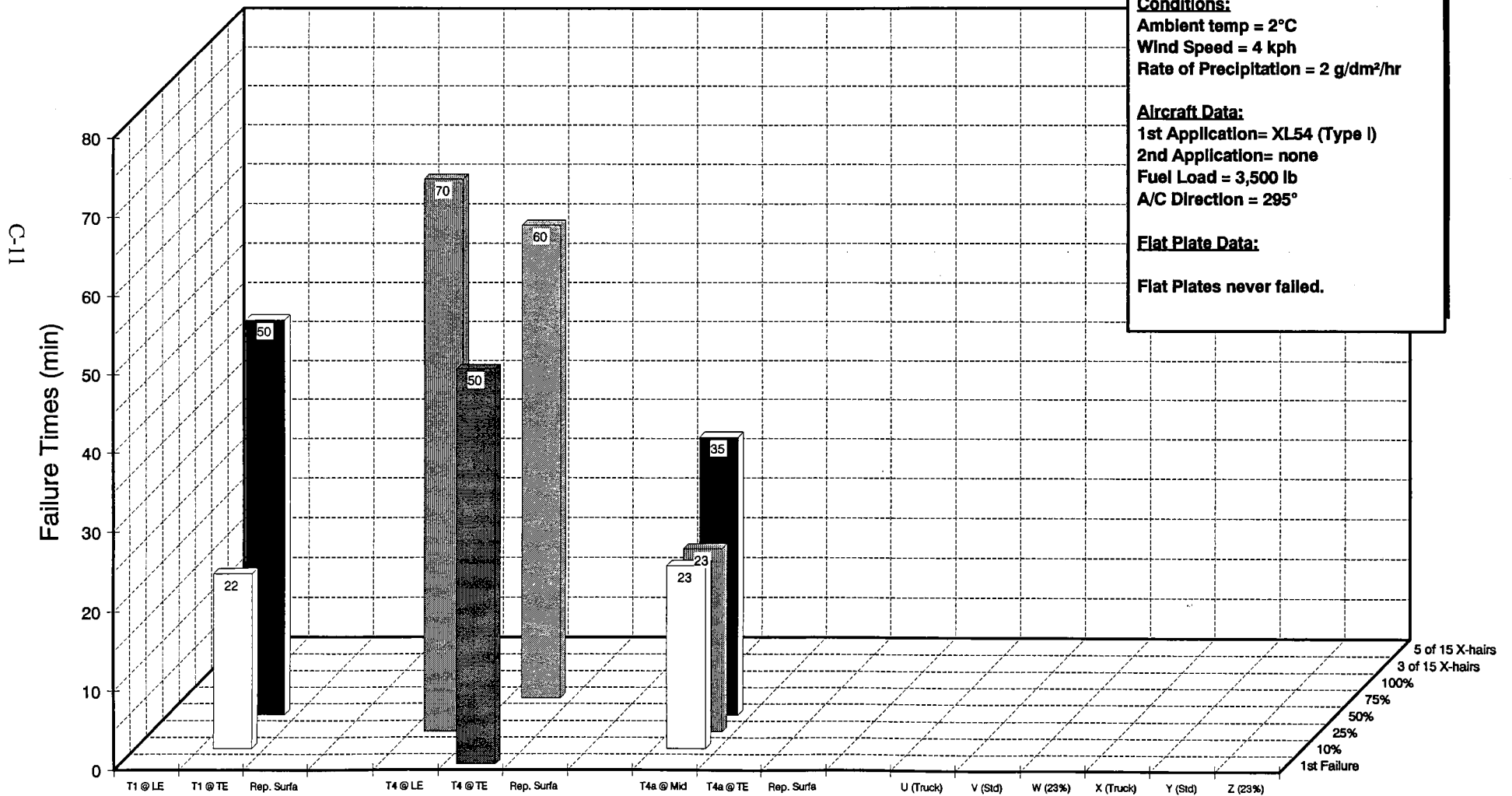

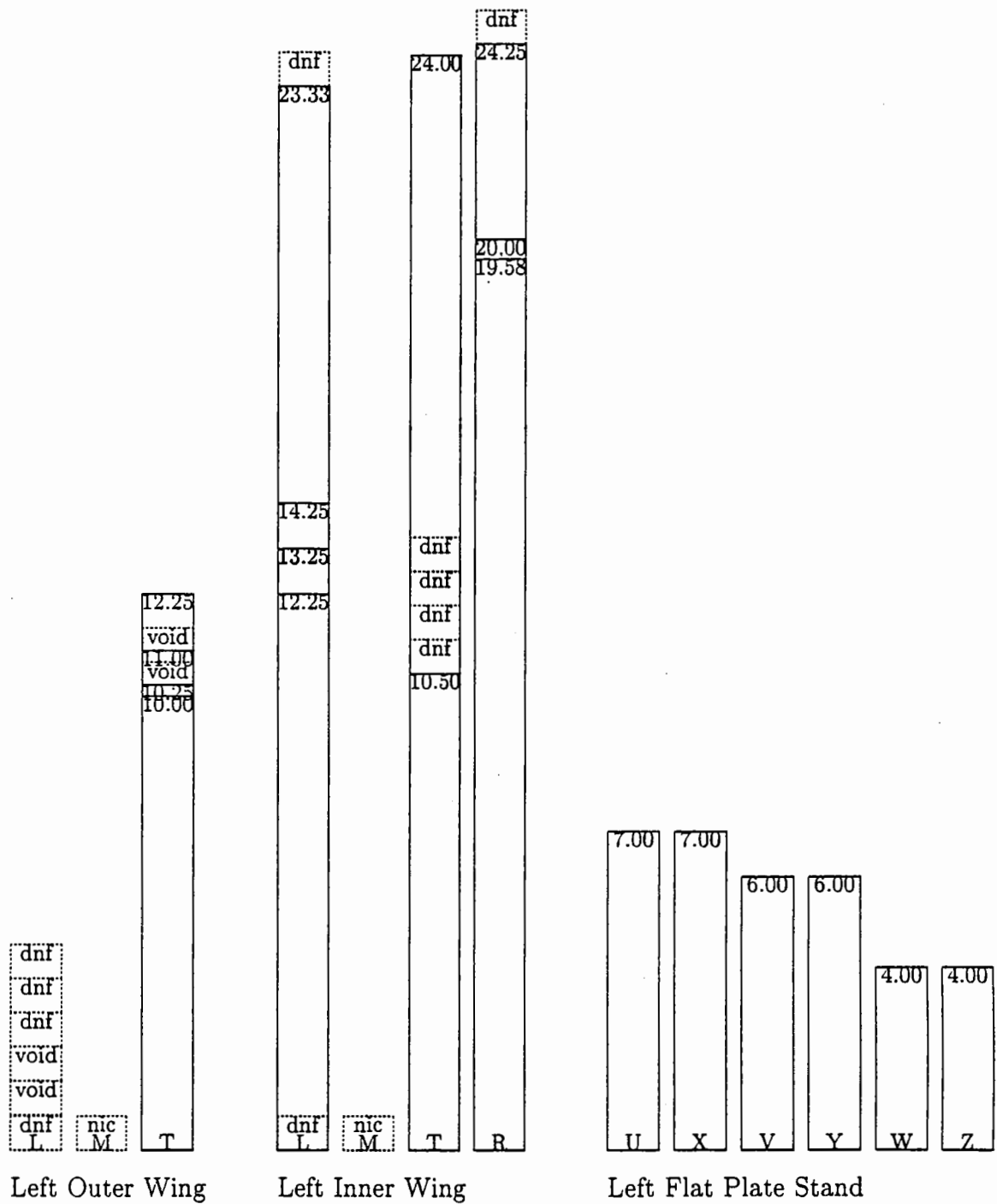

Figure 32: Test 1A Left - DC-9 Fluid Failure Observation Times: Amb. Tmp. -6.22°C, W. Spd. 31.48km/hr, W. Dir. 50° E of N, Precip. Rate 9.71 g/dm²/hr, Aircraft Orien. 350° E of N, F/P Orien. 50° E of N.

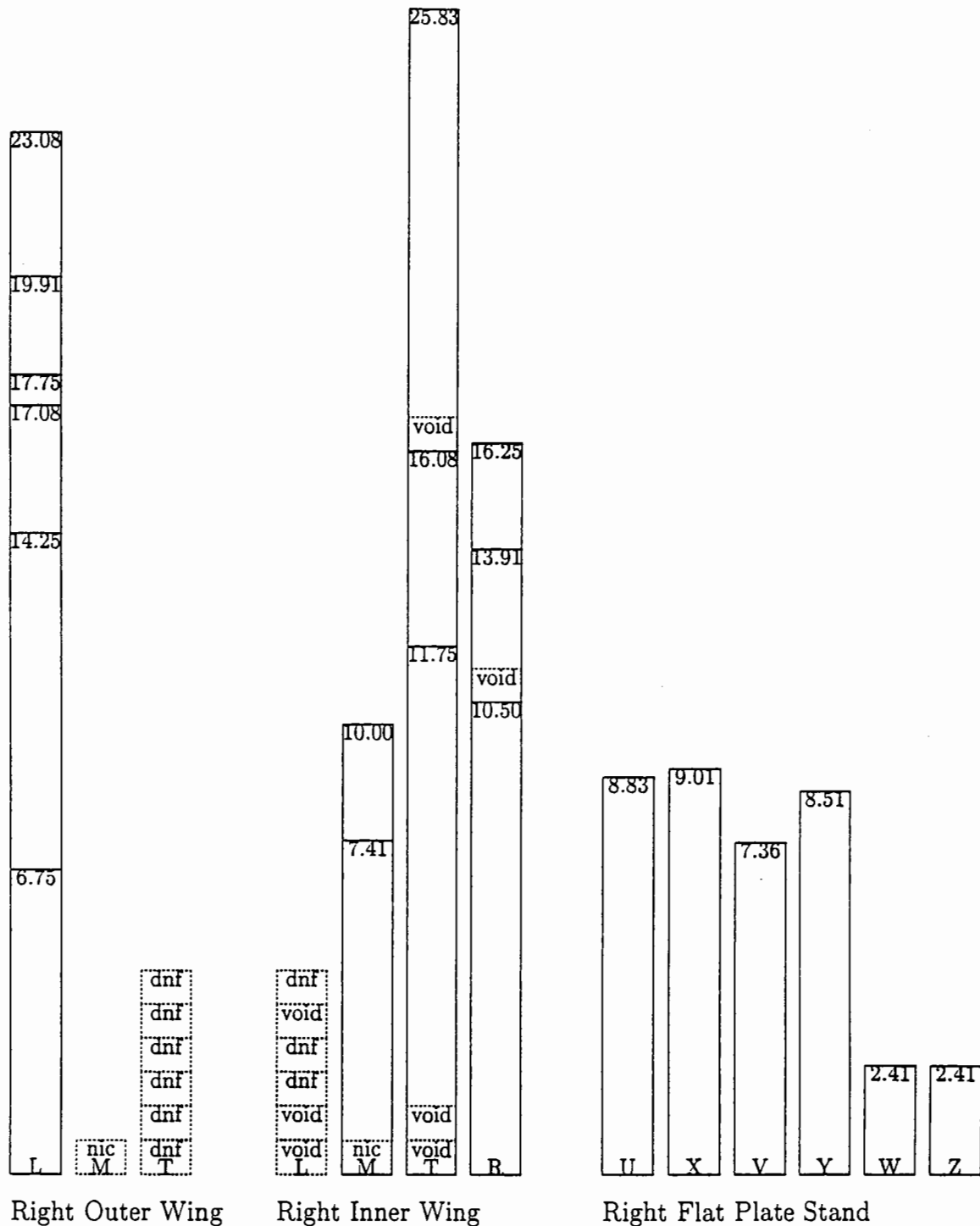

Figure 33: Test 1A Right - DC-9 Fluid Failure Observation Times: Amb. Tmp. -6.22°C, W. Spd. 31.48km/hr, W. Dir. 50° E of N, Precip. Rate 9.71 g/dm²/hr, Aircraft Orien. 350° E of N, F/P Orien. 50° E of N.

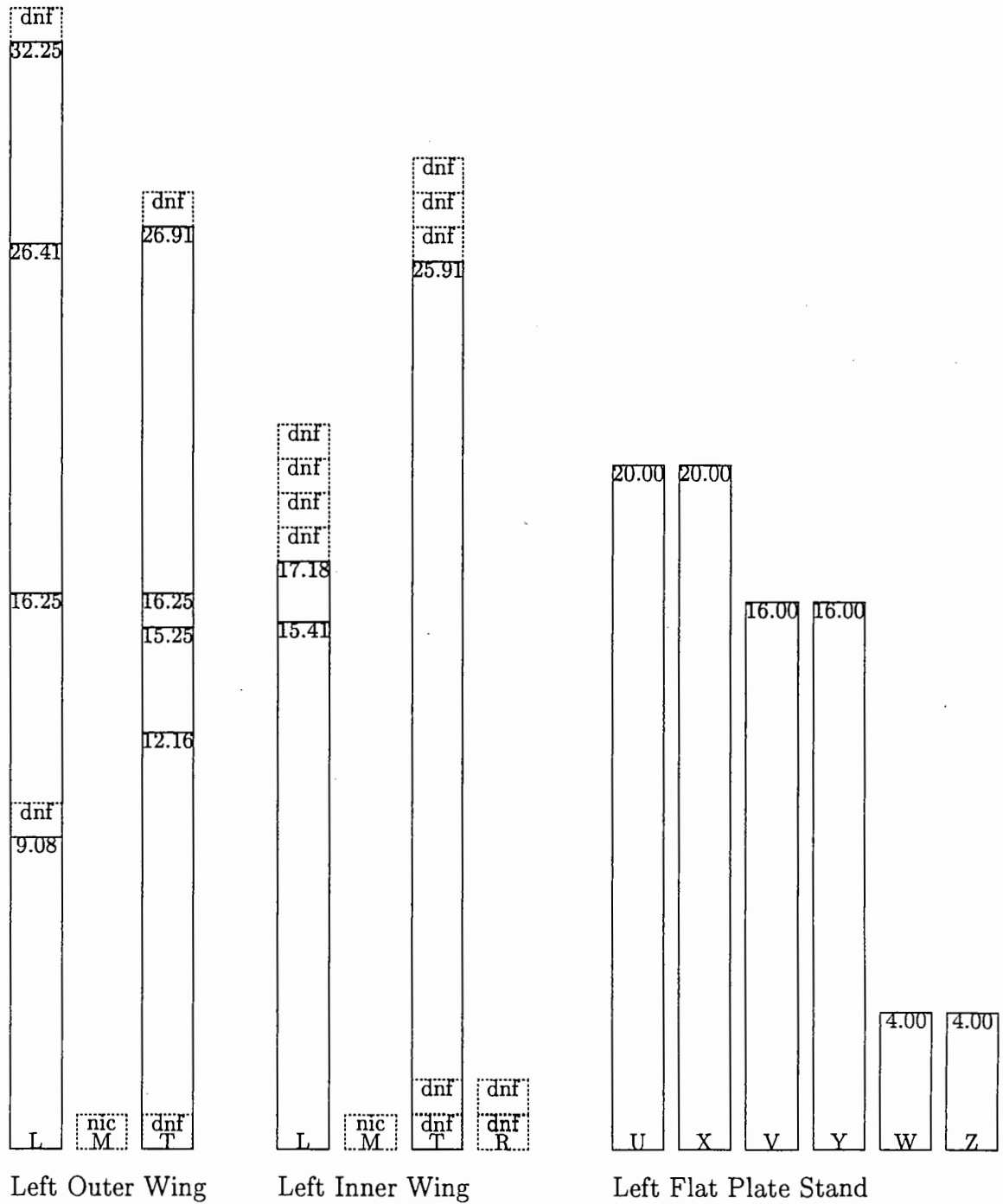

Figure 34: Test 1B Left - DC-9 Fluid Failure Observation Times: Amb. Tmp. -6.80°C, W. Spd. 24.10km/hr, W. Dir. 35° E of N, Precip. Rate 1.83 g/dm²/hr, Aircraft Orien. 350° E of N, F/P Orien. 50° E of N.

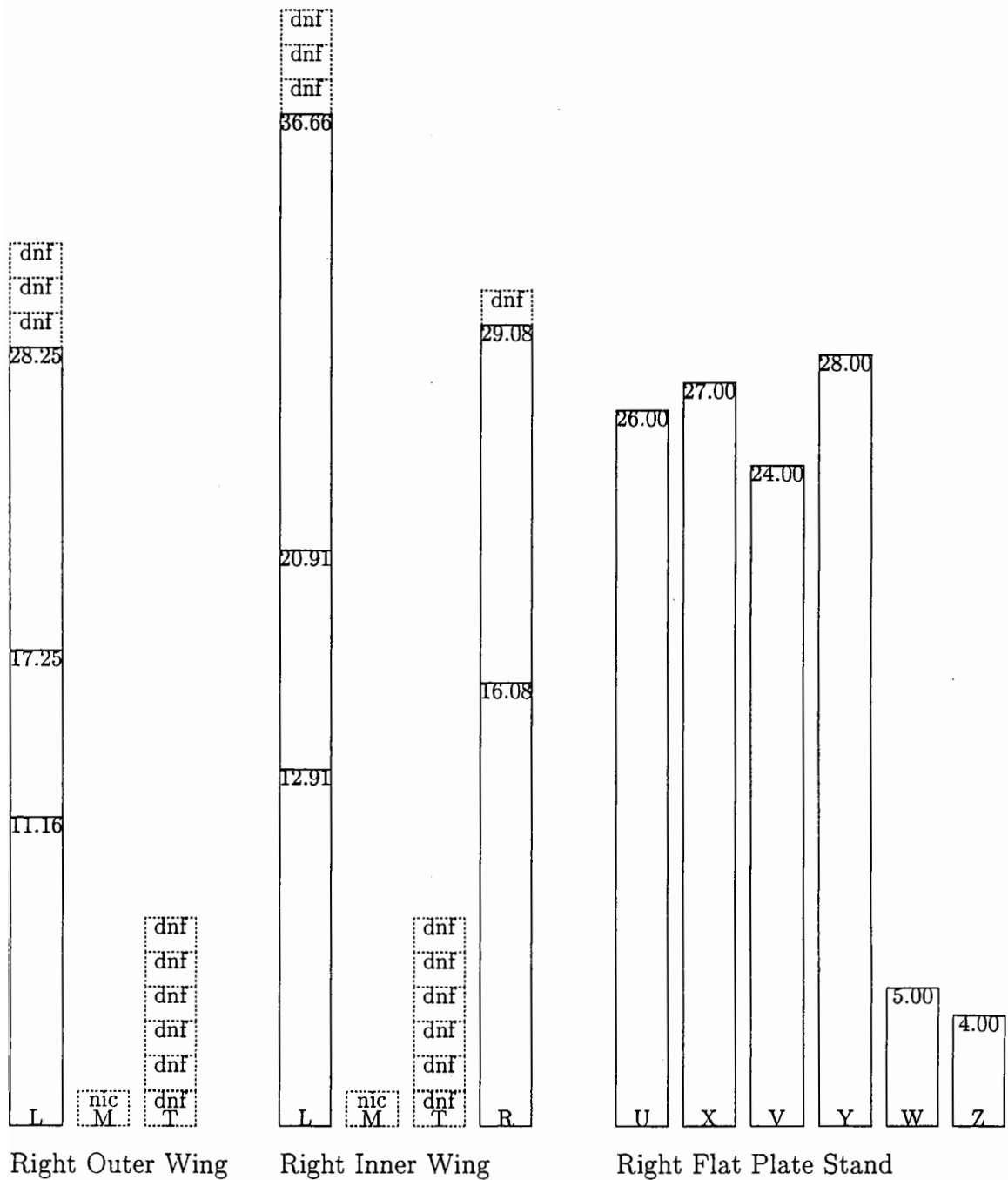

Figure 35: Test 1B Right - DC-9 Fluid Failure Observation Times: Amb. Tmp. -6.80°C, W. Spd. 24.10km/hr, W. Dir. 35° E of N, Precip. Rate 1.83 g/dm²/hr, Aircraft Orien. 350° E of N, F/P Orien. 50° E of N.

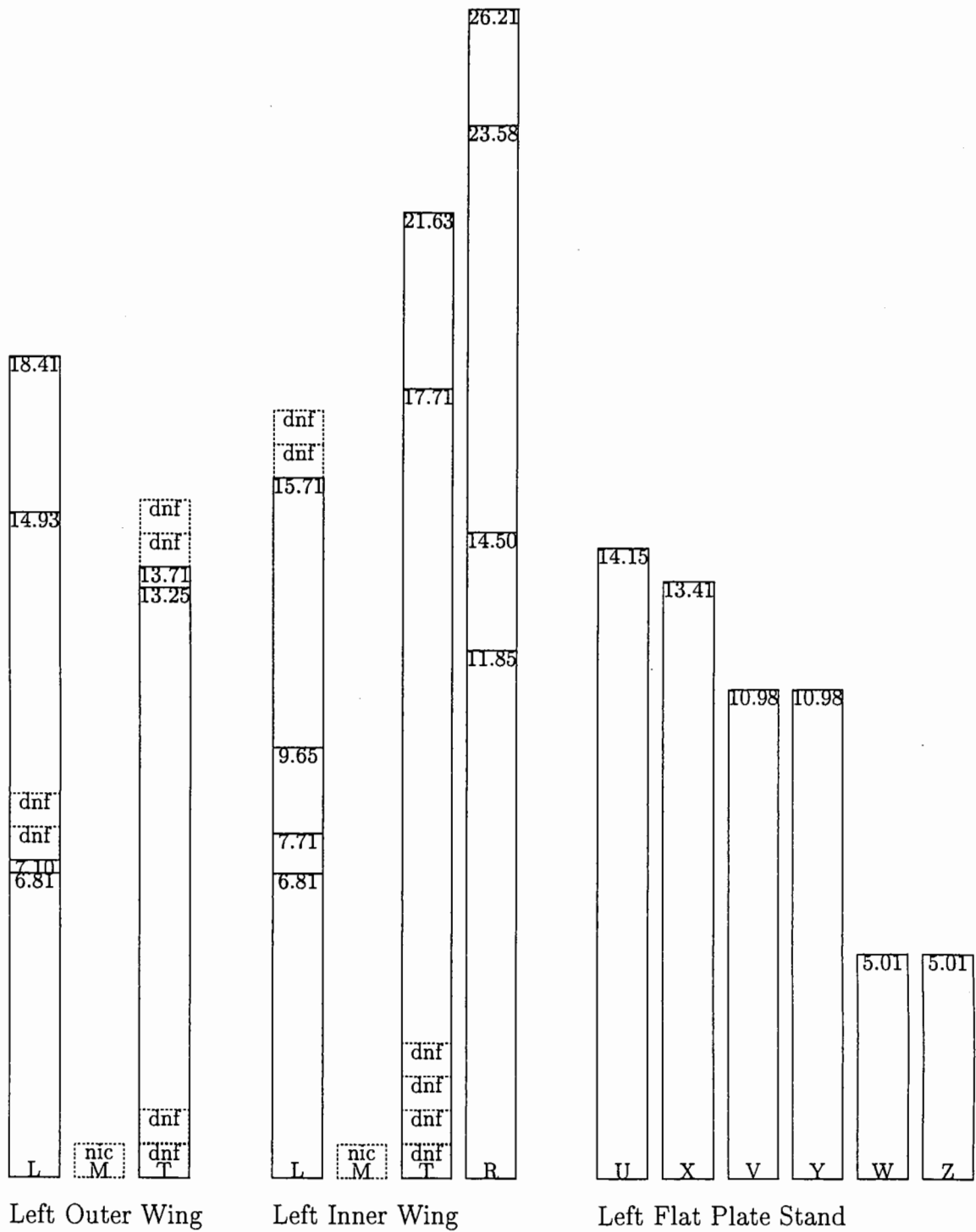

Figure 36: Test 2A Left - DC-9 Fluid Failure Observation Times: Amb. Tmp. -5.13°C , W. Spd. 27.78km/hr , W. Dir. 70° E of N, Precip. Rate $6.82\text{ g/dm}^2/\text{hr}$, Aircraft Orien. 80° E of N, F/P Orien. 80° E of N.

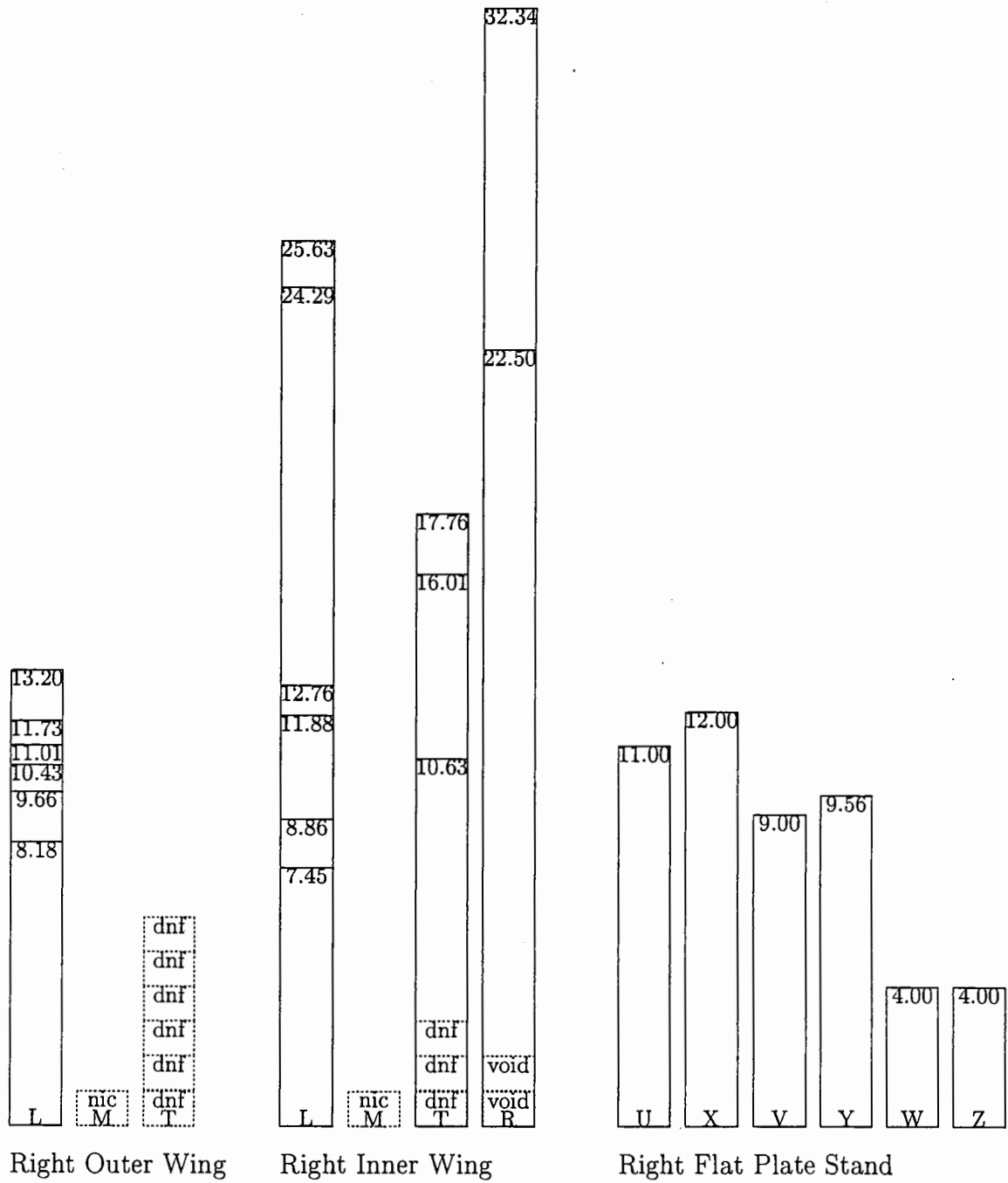

Figure 37: Test 2A Right - DC-9 Fluid Failure Observation Times: Amb. Tmp. -5.13°C , W. Spd. 27.78km/hr , W. Dir. 70° E of N, Precip. Rate $6.82\text{g/dm}^2/\text{hr}$, Aircraft Orien. 80° E of N, F/P Orien. 80° E of N.

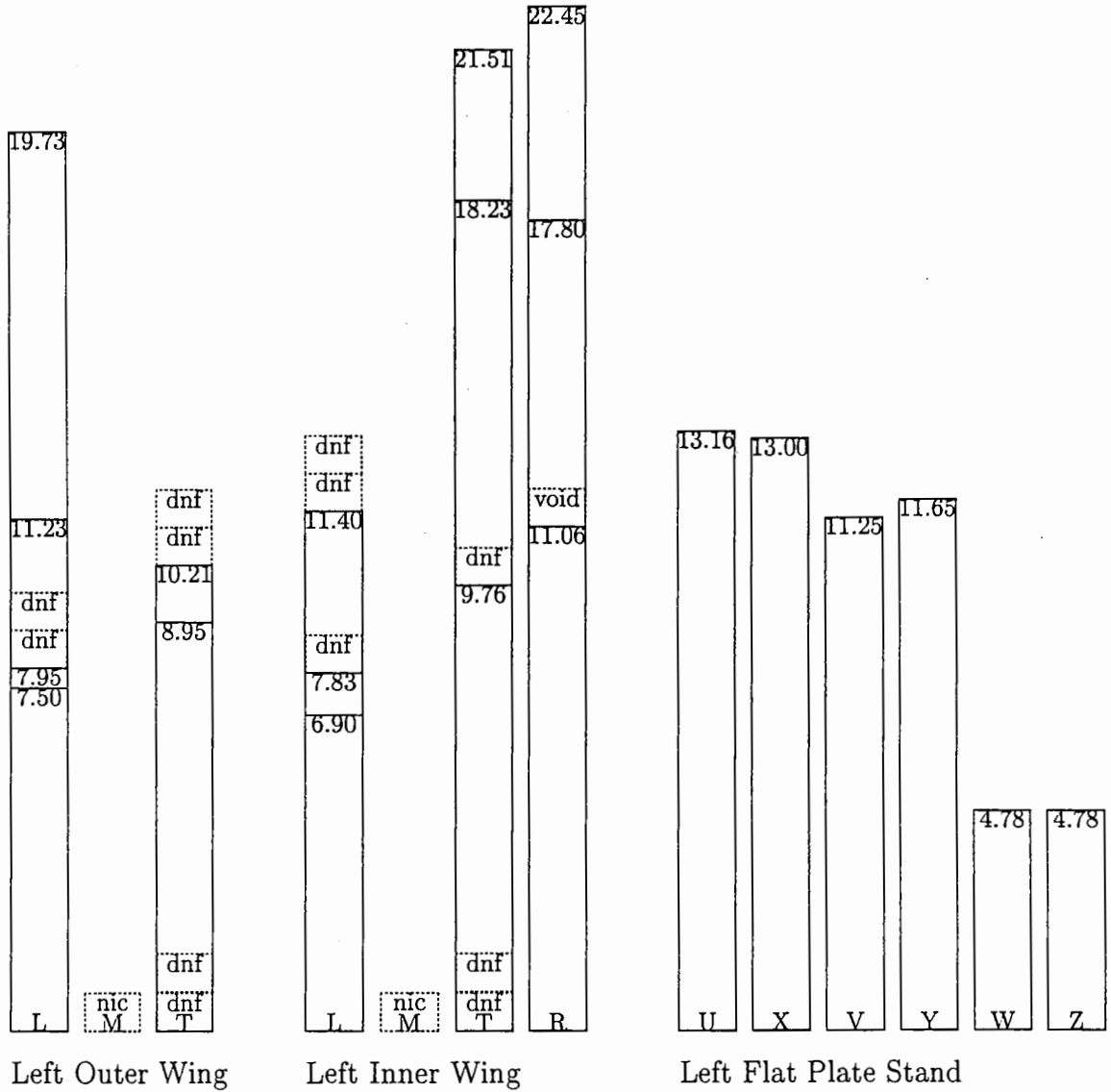

Figure 38: Test 2B Left - DC-9 Fluid Failure Observation Times: Amb. Tmp. -6.25°C, W. Spd. 25.9km/hr, W. Dir. 70° E of N, Precip. Rate 15.06 g/dm²/hr, Aircraft Orien. 80° E of N, F/P Orien. 80° E of N.

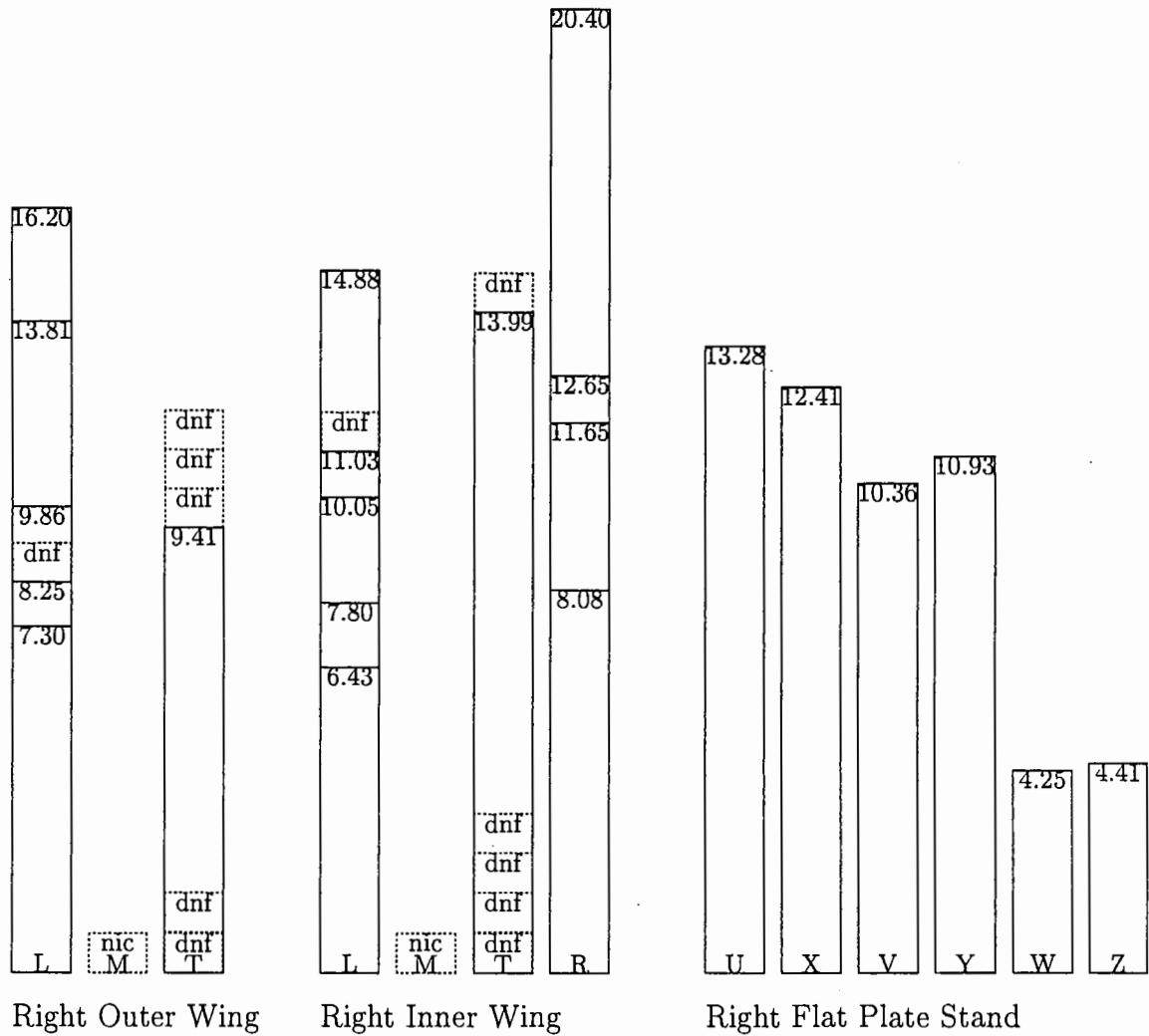

Figure 39: Test 2B Right - DC-9 Fluid Failure Observation Times: Amb. Tmp. -6.25°C , W. Spd. 25.9km/hr , W. Dir. 70° E of N, Precip. Rate $15.06\text{g/dm}^2/\text{hr}$, Aircraft Orien. 80° E of N, F/P Orien. 80° E of N.

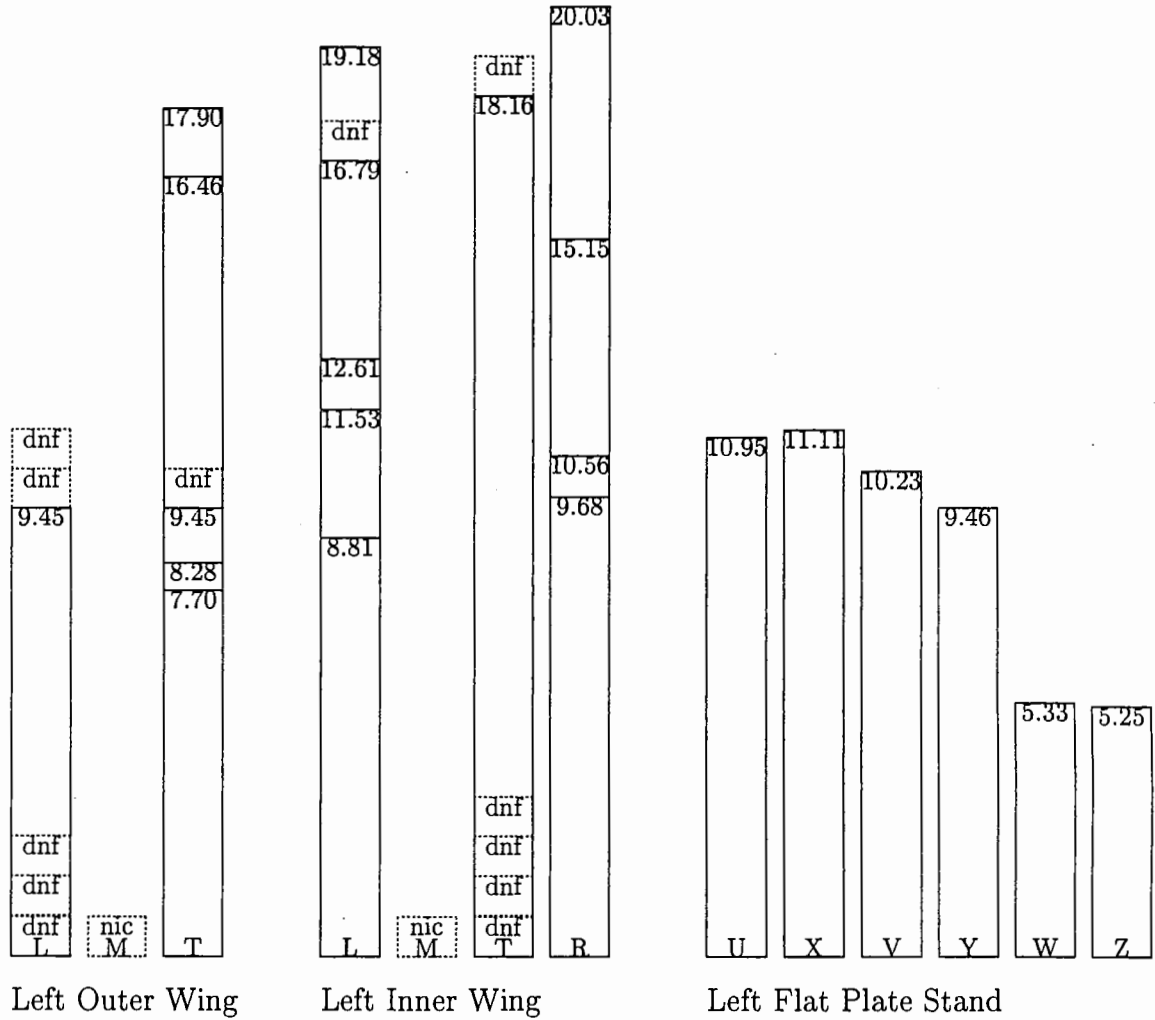

Figure 40: Test 2C Left - DC-9 Fluid Failure Observation Times: Amb. Tmp. -6.58°C, W. Spd. 24.07km/hr, W. Dir. 70° E of N, Precip. Rate 17.09 g/dm²/hr, Aircraft Orien. 80° E of N, F/P Orien. 80° E of N.

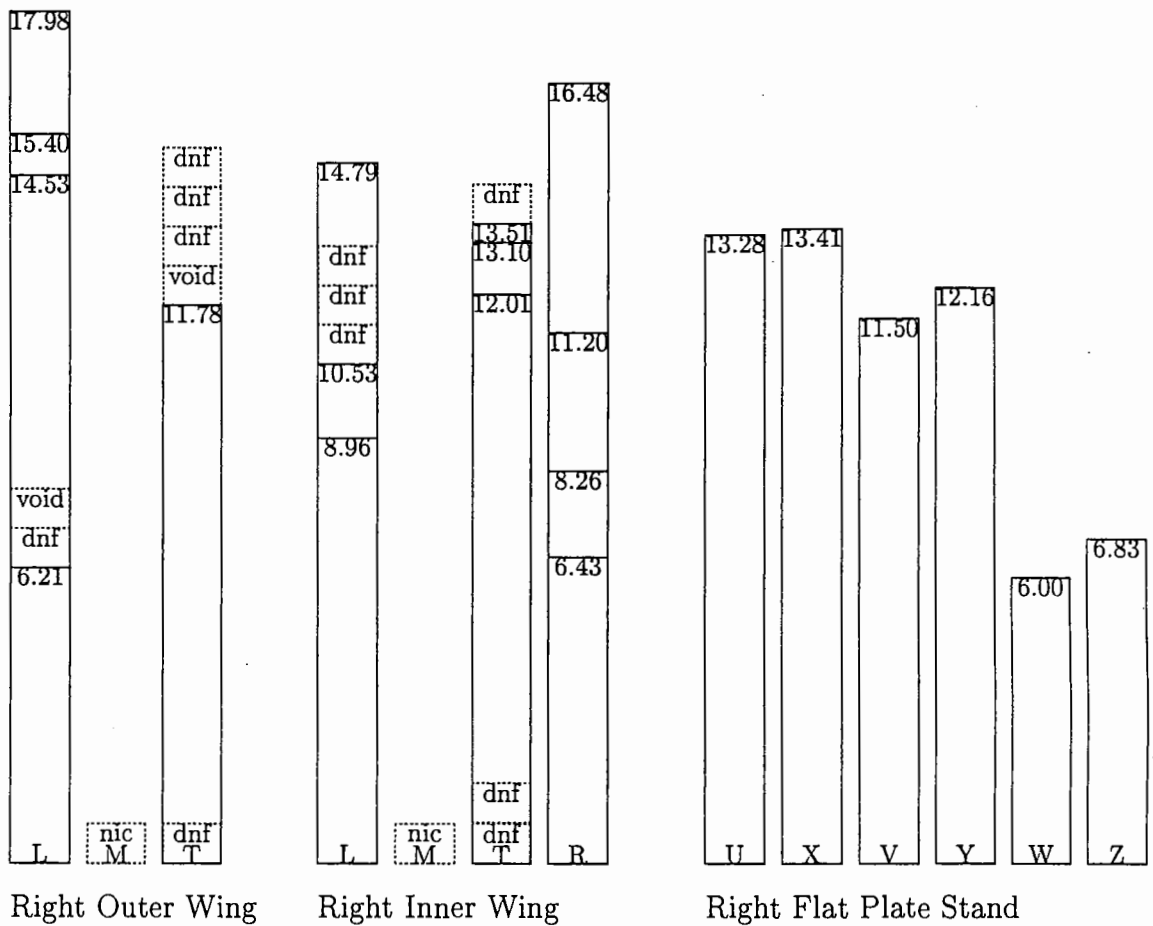

Figure 41: Test 2C Right - DC-9 Fluid Failure Observation Times: Amb. Tmp. -6.58°C, W. Spd. 24.07km/hr, W. Dir. 70° E of N, Precip. Rate 17.09 g/dm²/hr, Aircraft Orien. 80° E of N, F/P Orien. 80° E of N.

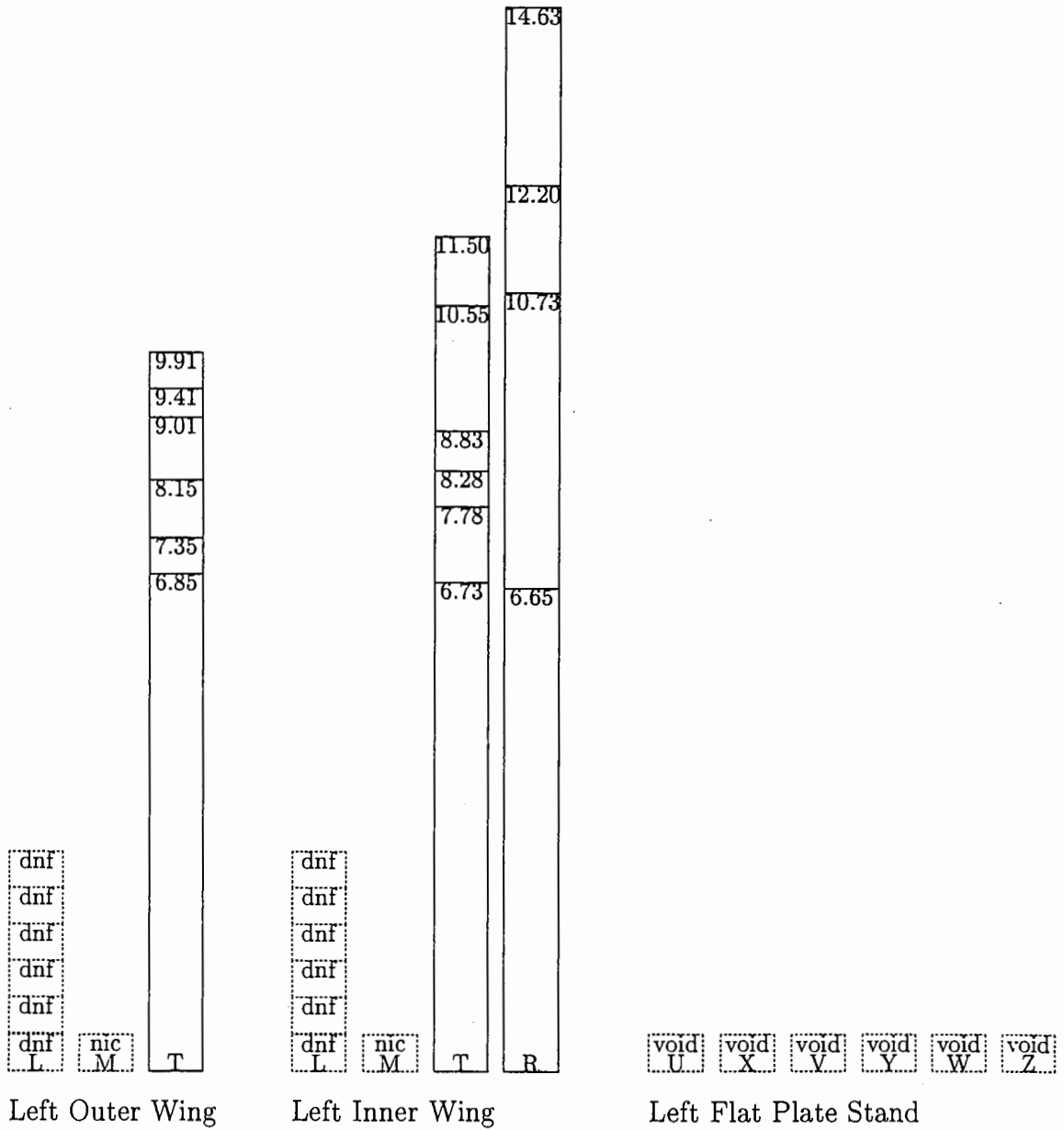

Figure 42: Test 3A Left - DC-9 Fluid Failure Observation Times: Amb. Tmp. -6.0°C, W. Spd. 9.26km/hr, W. Dir. 120° E of N, Precip. Rate 12.07 g/dm²/hr, Aircraft Orien. 110° E of N, F/P Orien. 115° E of N.

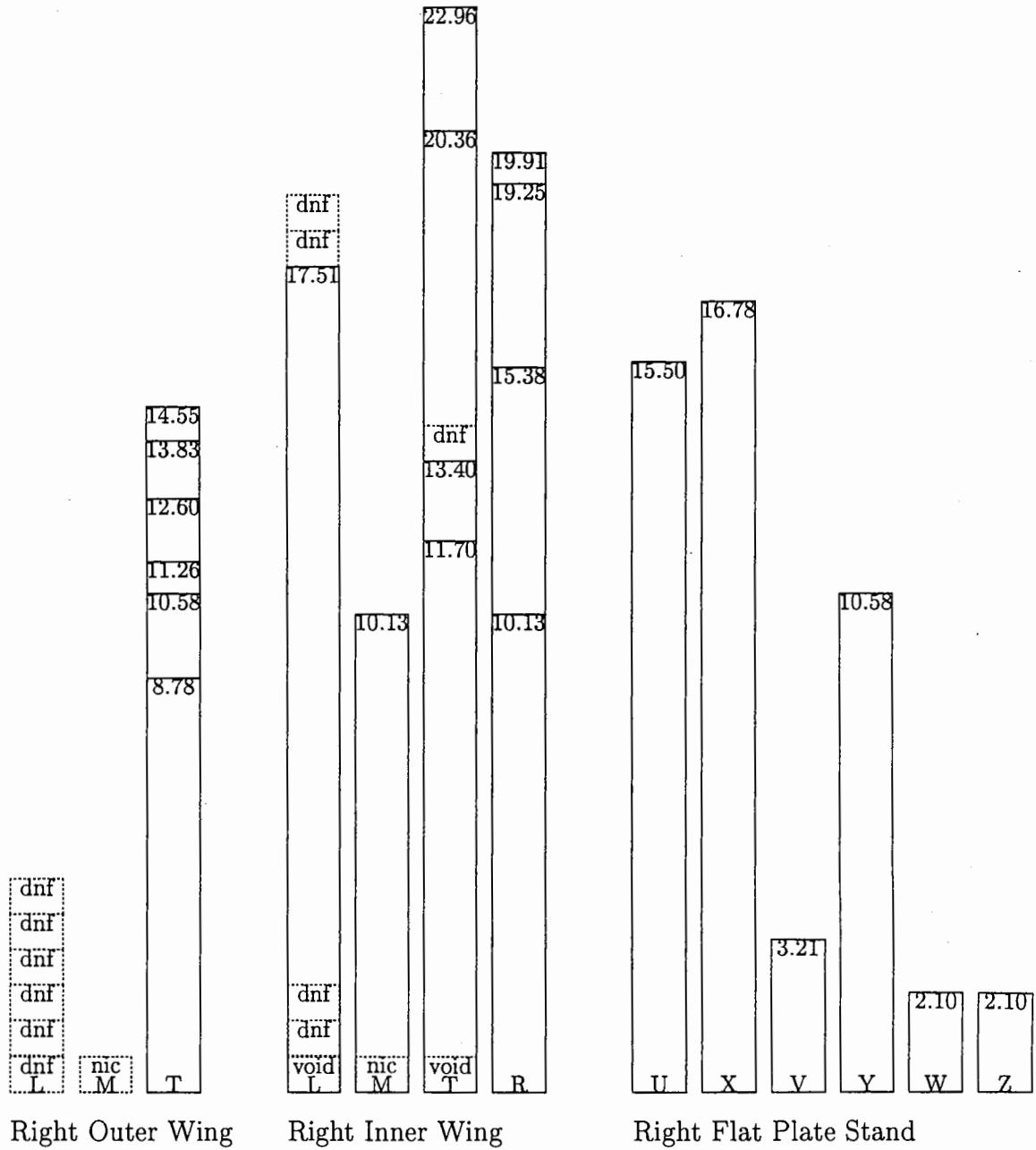

Figure 43: Test 3A Right - DC-9 Fluid Failure Observation Times: Amb. Tmp. -6.0°C , W. Spd. 9.26km/hr , W. Dir. 120° E of N, Precip. Rate $12.07\text{ g/dm}^2/\text{hr}$, Aircraft Orien. 110° E of N, F/P Orien. 115° E of N.

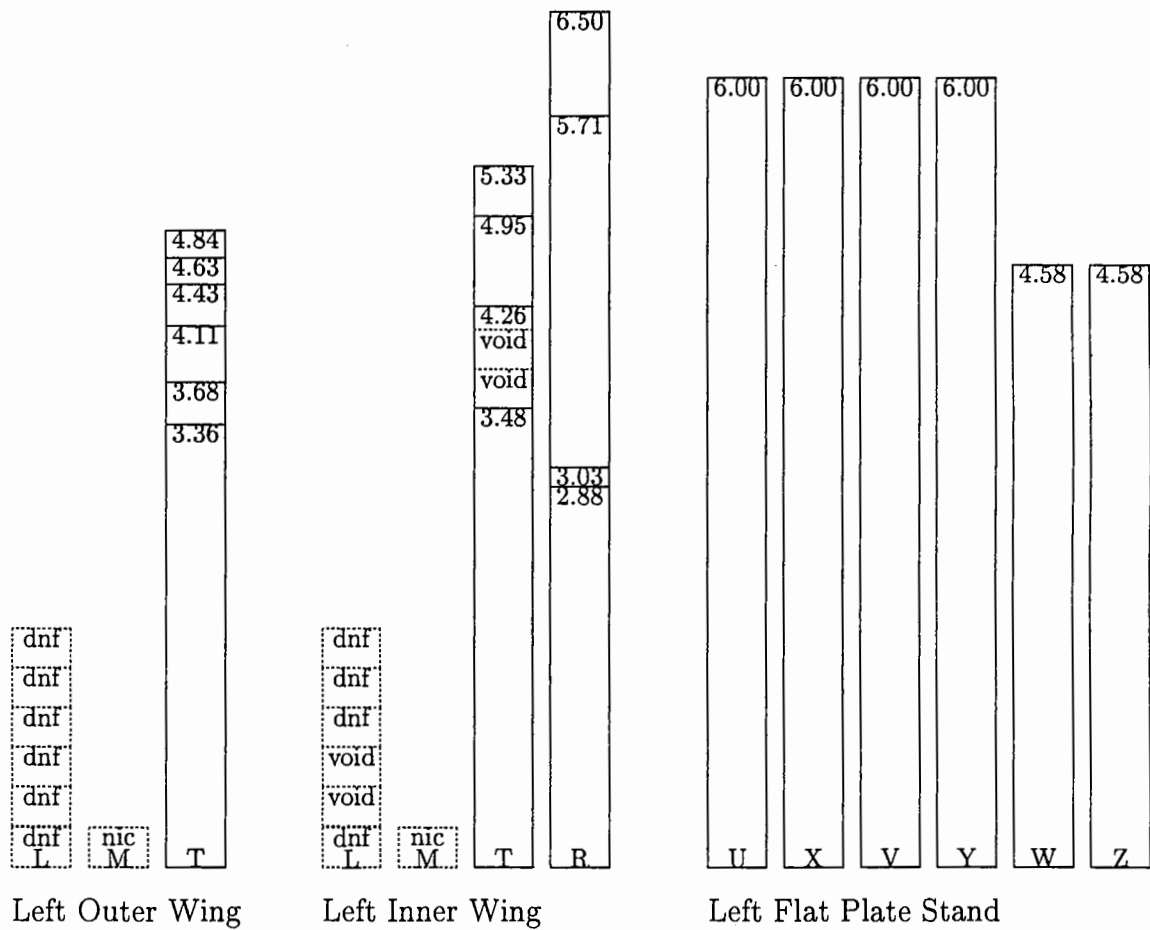

Figure 44: Test 3B Left - DC-9 Fluid Failure Observation Times: Amb. Tmp. -5.7°C , W. Spd. 5.18km/hr, W. Dir. 110° E of N, Precip. Rate $25.9 \text{ g/dm}^2/\text{hr}$, Aircraft Orien. 110° E of N, F/P Orien. 115° E of N.

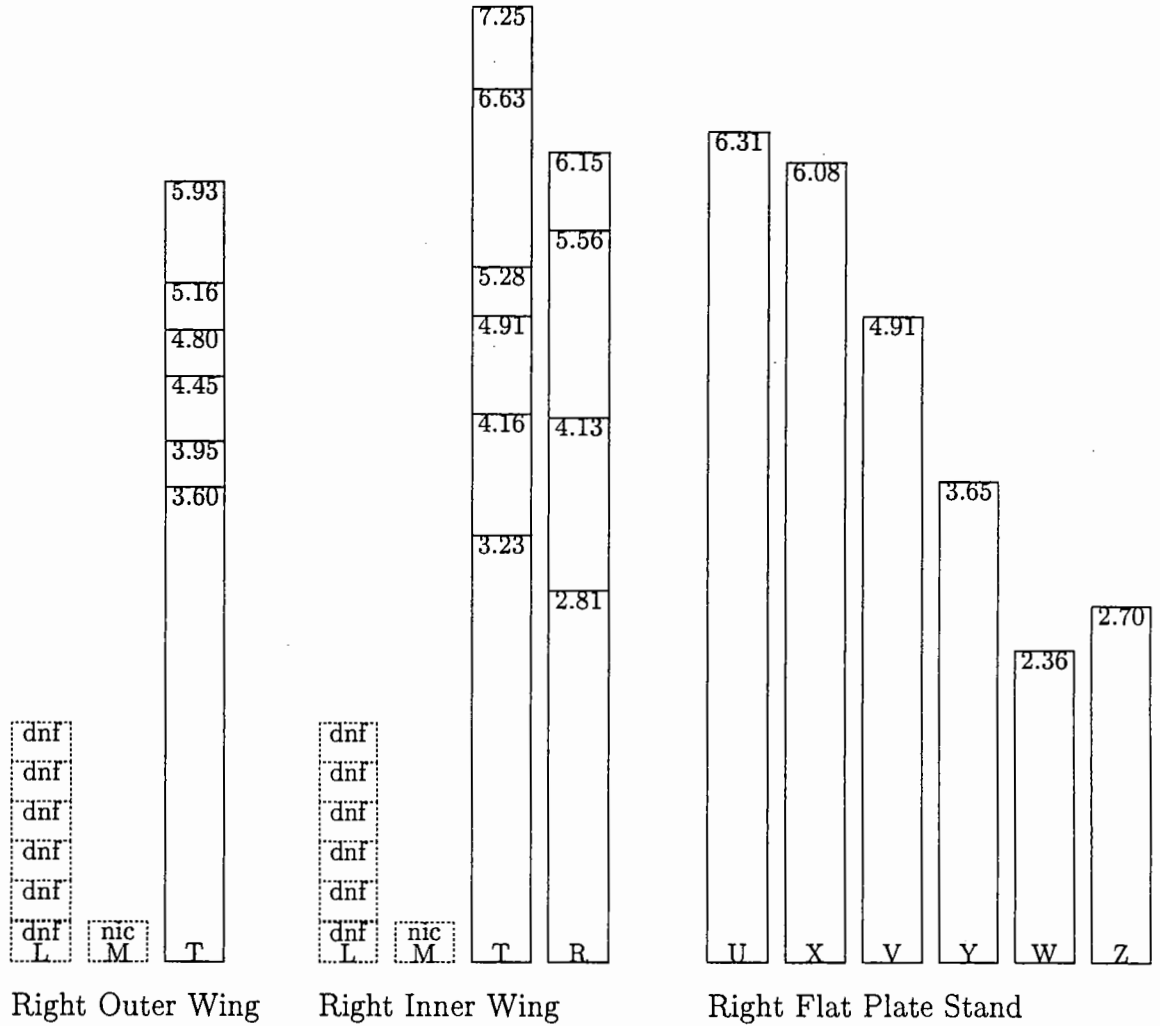

Figure 45: Test 3B Right - DC-9 Fluid Failure Observation Times: Amb. Tmp. -5.7°C , W. Spd. 5.18km/hr , W. Dir. 110° E of N, Precip. Rate $25.9\text{g/dm}^2/\text{hr}$, Aircraft Orient. 110° E of N, F/P Orient. 115° E of N.

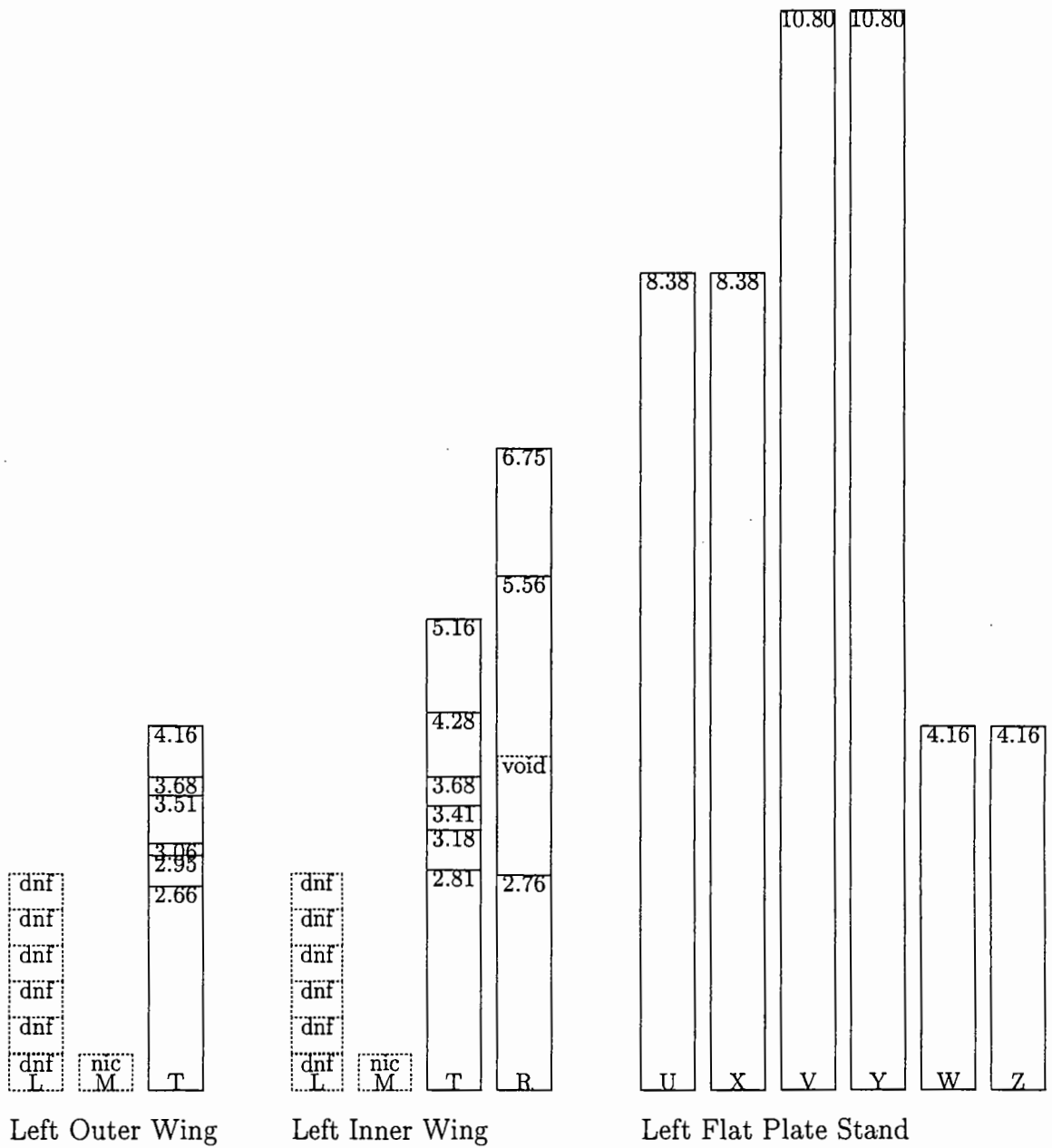

Figure 46: Test 3C Left - DC-9 Fluid Failure Observation Times: Amb. Tmp. -5.3°C, W. Spd. 5.18km/hr, W. Dir. 120° E of N, Precip. Rate 22.55 g/dm²/hr, Aircraft Orien. 110° E of N, F/P Orien. 115° E of N.

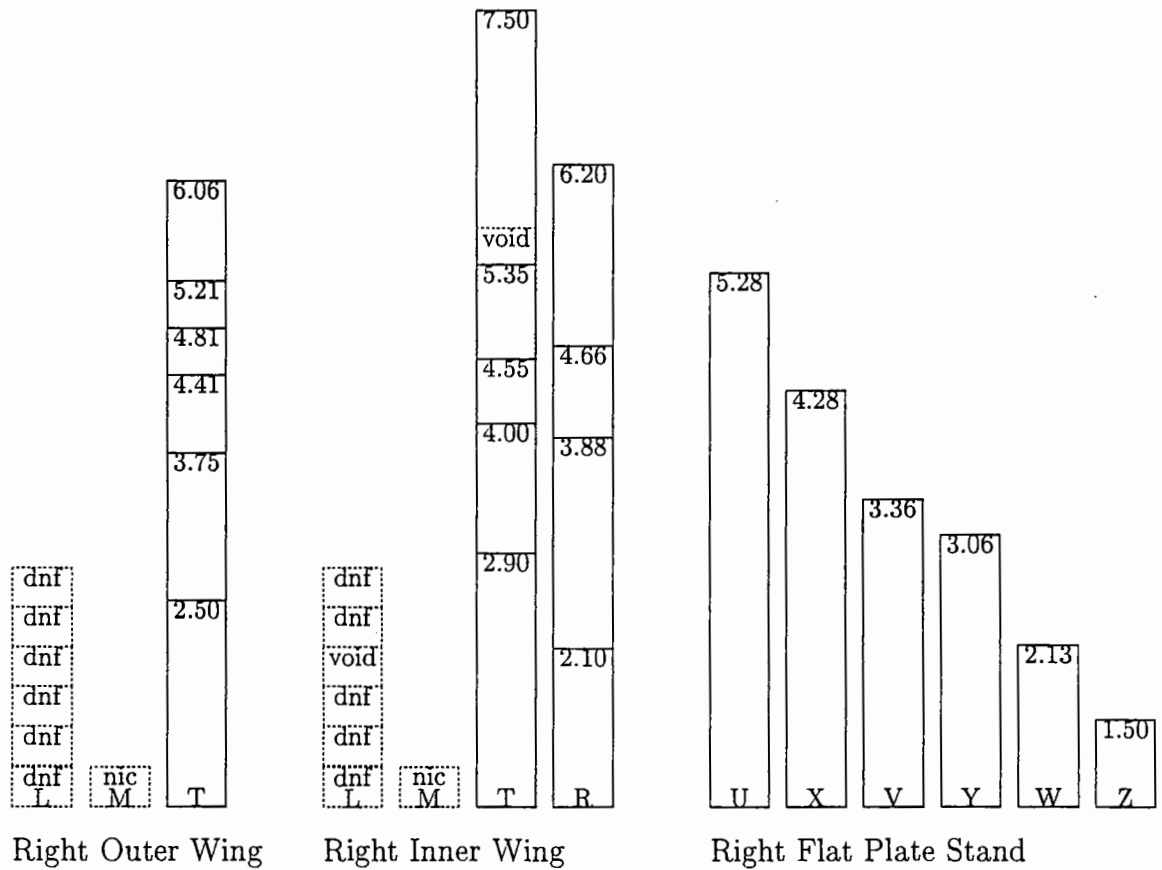

Figure 47: Test 3C Right - DC-9 Fluid Failure Observation Times: Amb. Tmp. -5.3°C , W. Spd. 5.18km/hr , W. Dir. 120° E of N, Precip. Rate $22.55\text{ g/dm}^2/\text{hr}$, Aircraft Orien. 110° E of N, F/P Orien. 115° E of N.

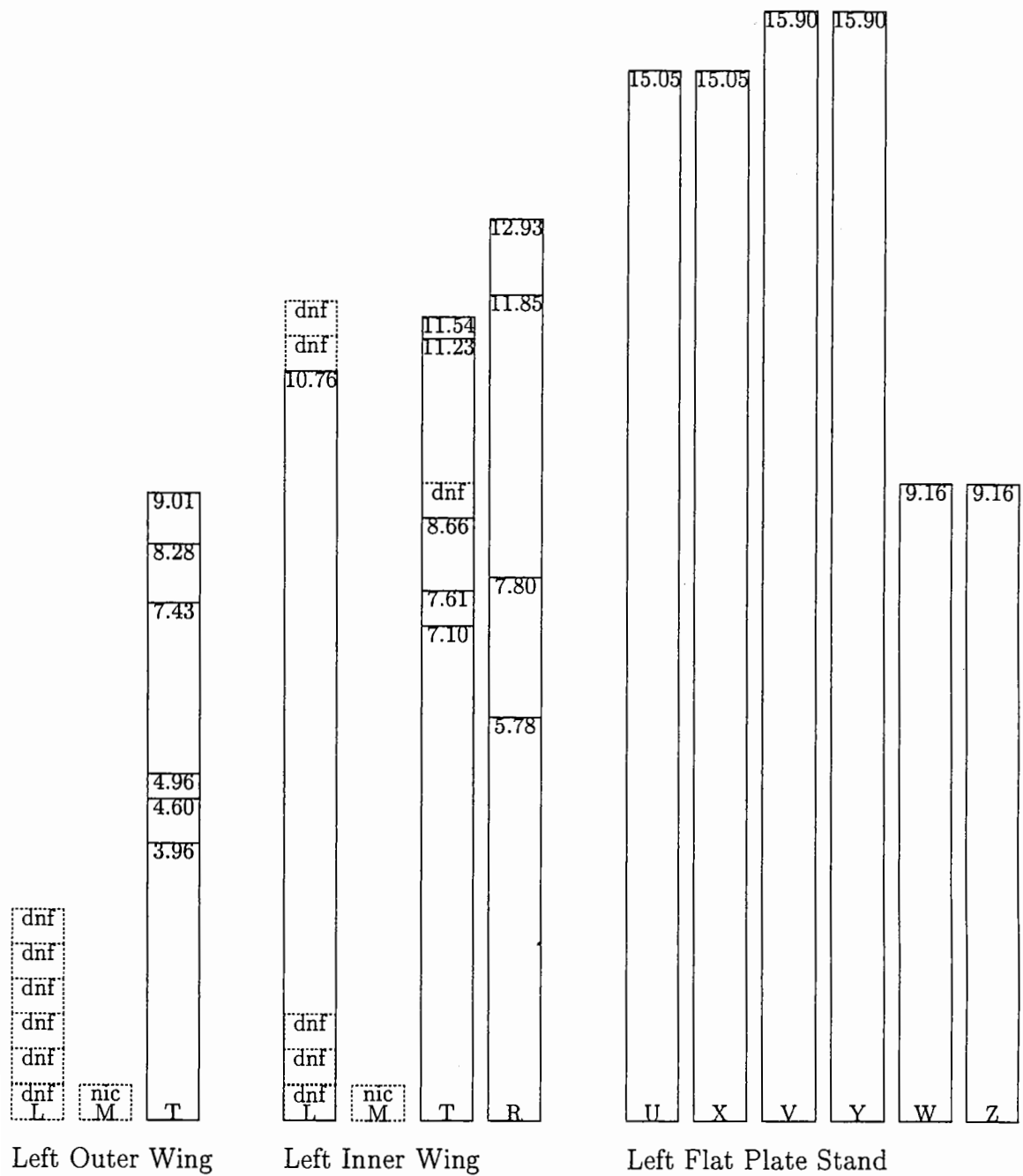

Figure 48: Test 3D Left - DC-9 Fluid Failure Observation Times: Amb. Tmp. -5.4°C , W. Spd. 5.86km/hr , W. Dir. 120° E of N, Precip. Rate $9.69\text{ g/dm}^2/\text{hr}$, Aircraft Orien. 110° E of N, F/P Orien. 115° E of N.

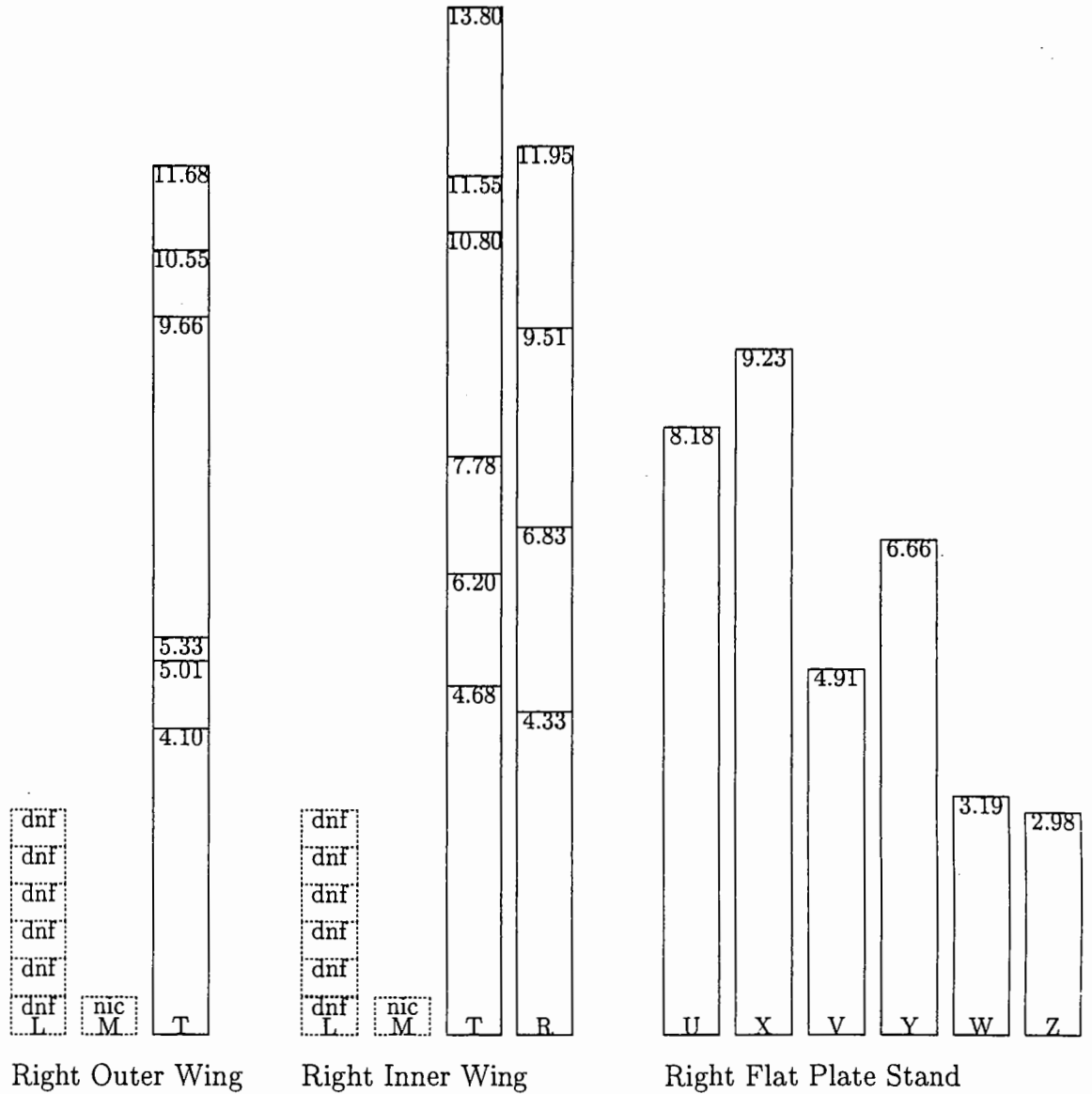

Figure 49: Test 3D Right - DC-9 Fluid Failure Observation Times: Amb. Tmp. -5.4°C , W. Spd. 5.86km/hr , W. Dir. 120° E of N, Precip. Rate $9.69\text{ g/dm}^2/\text{hr}$, Aircraft Orien. 110° E of N, F/P Orien. 115° E of N.

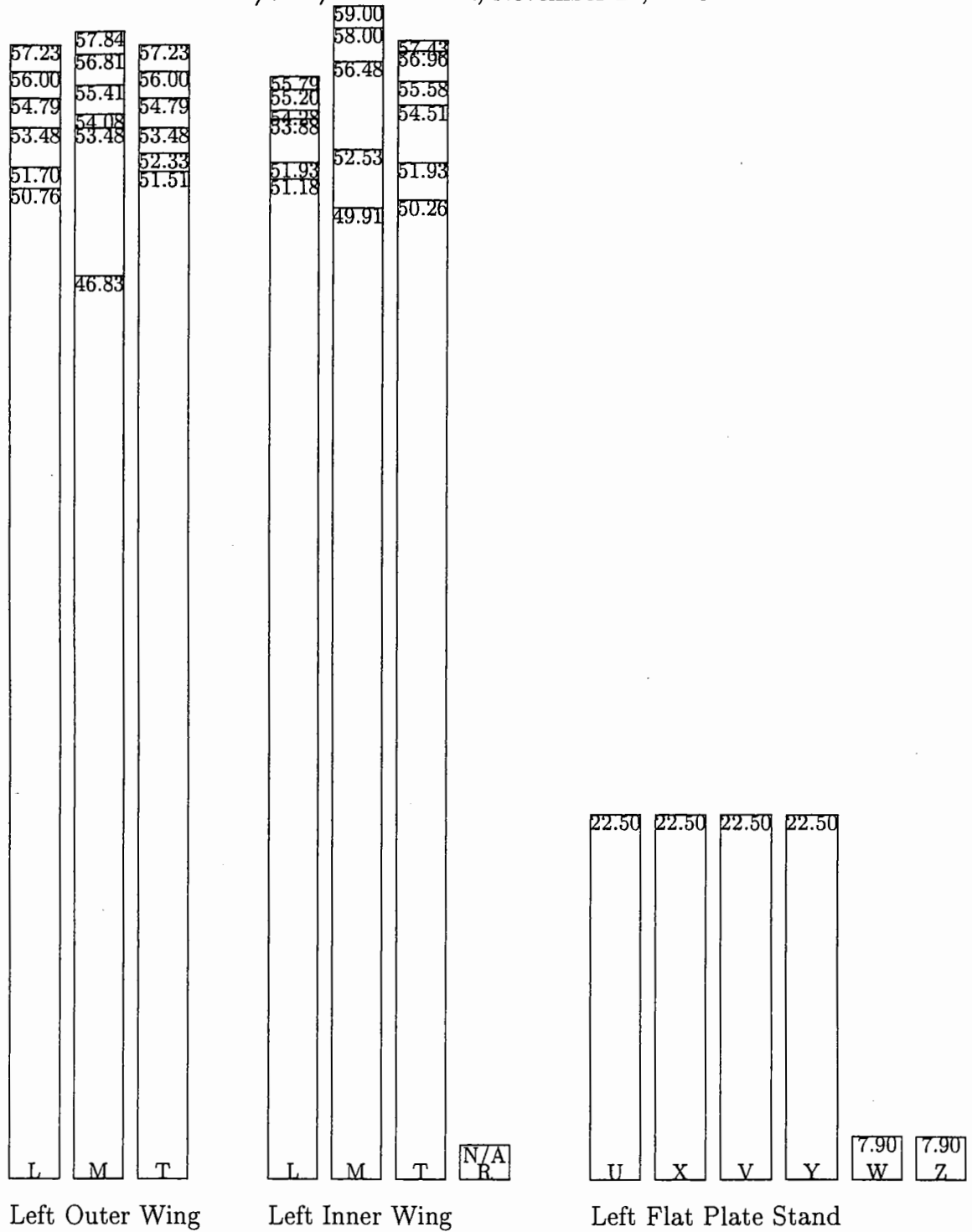

Figure 50: Test 4A - Left BAe-146 Fluid Failure Observation Times: Amb. Tmp. -1.5°C , W. Spd. 37.04km/hr, W. Dir. 35° E of N, Precip. Rate 15.77 g/dm²/hr, Aircraft Orien. 35° E of N, F/P Orien. 35° E of N.

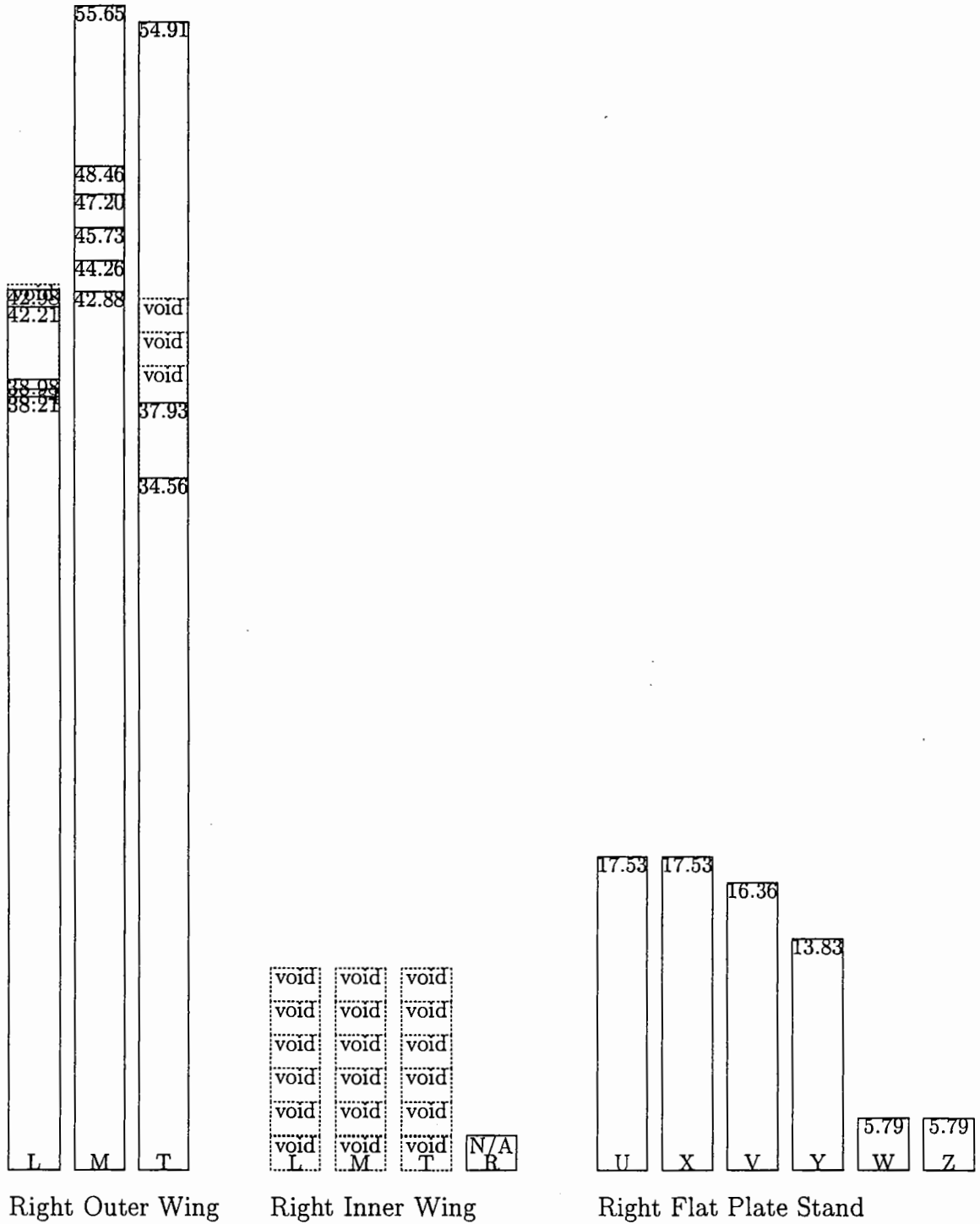

Figure 51: Test 4A Right - BAe-146 Fluid Failure Observation Times: Amb. Tmp. -1.5°C, W. Spd. 37.04km/hr, W. Dir. 35° E of N, Precip. Rate 15.77 g/dm²/hr, Aircraft Orient. 35° E of N, F/P Orient. 35° E of N.

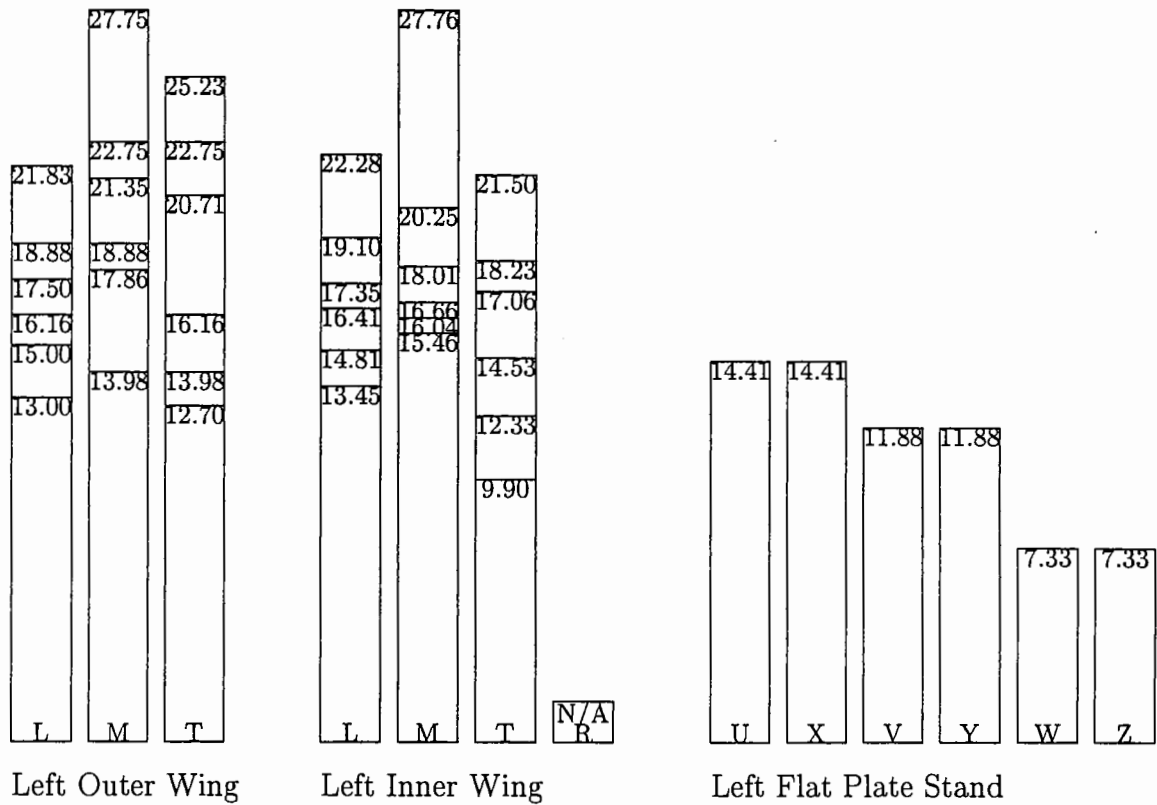

Figure 52: Test 4B Left - BAe-146 Fluid Failure Observation Times: Amb. Tmp. -1.9°C , W. Spd. 37.4km/hr, W. Dir. 35° E of N, Precip. Rate $21.58 \text{ g/dm}^2/\text{hr}$, Aircraft Orien. 35° E of N, F/P Orien. 35° E of N.

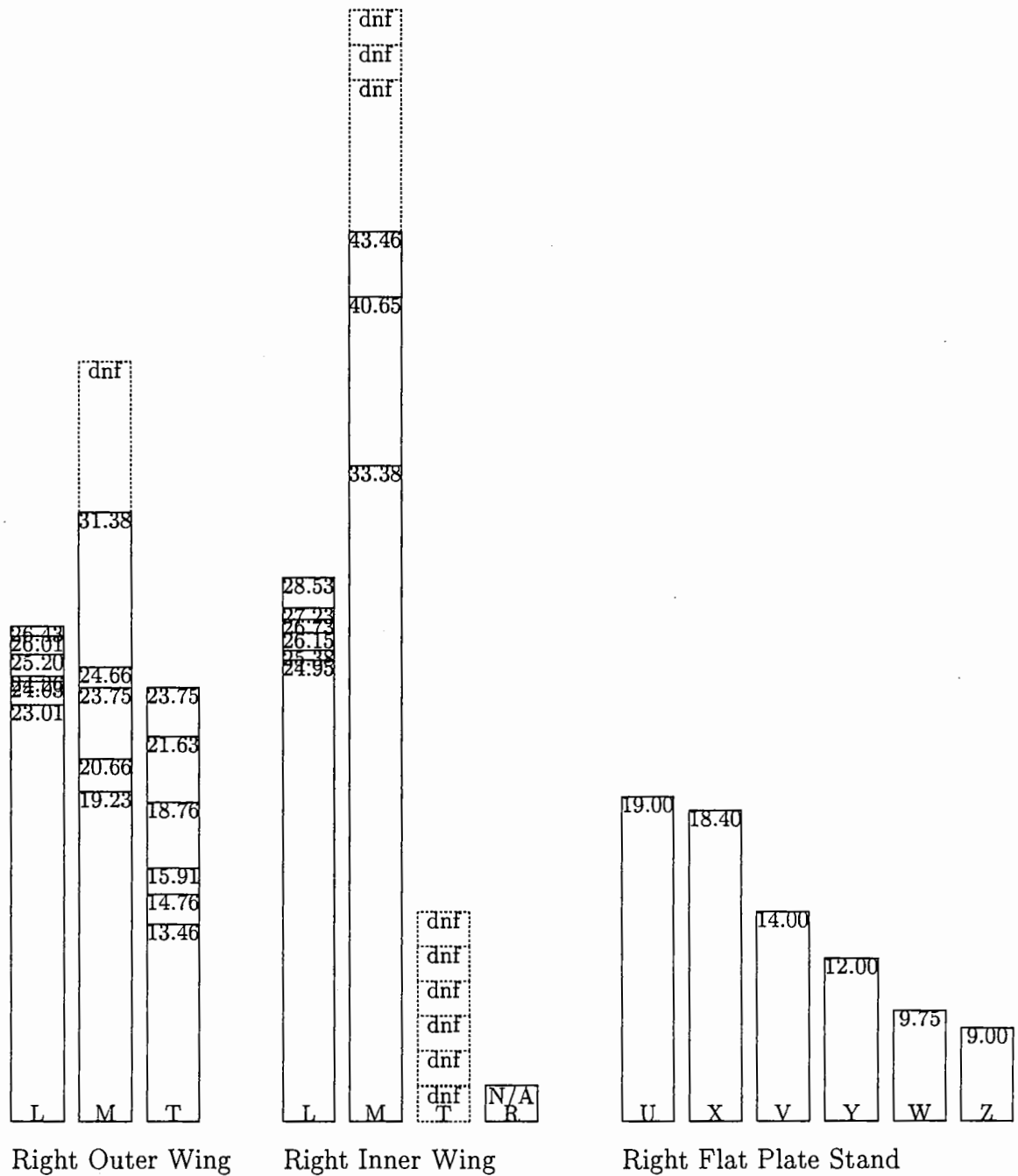

Figure 53: Test 4B Right - BAe-146 Fluid Failure Observation Times: Amb. Tmp. -1.9°C , W. Spd. 37.4km/hr, W. Dir. 35° E of N, Precip. Rate 21.58 g/dm²/hr, Aircraft Orien. 35° E of N, F/P Orien. 35° E of N.

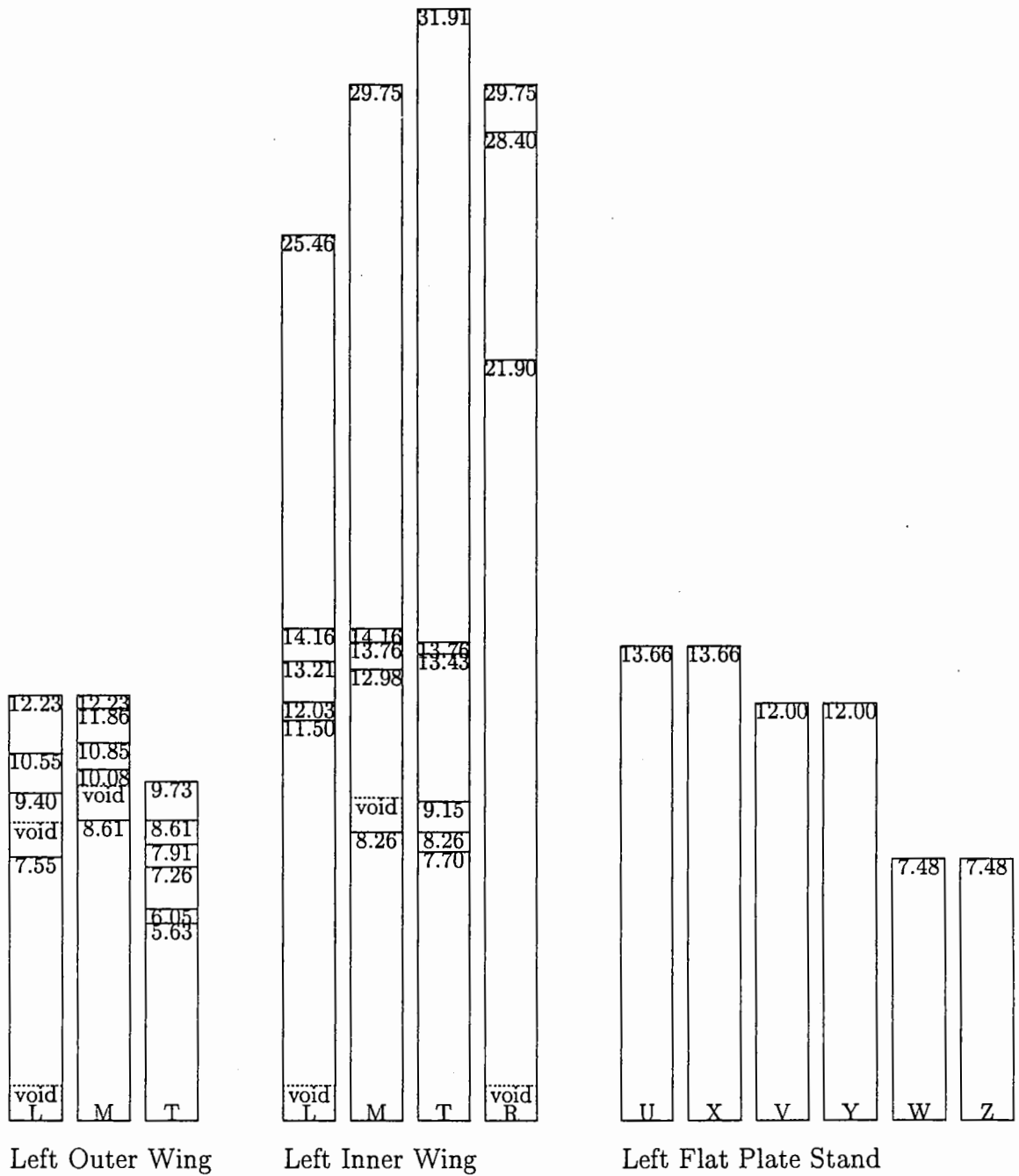

Figure 54: Test 5A Left - DC-9 Fluid Failure Observation Times: Amb. Tmp. -0.2°C , W. Spd. 35.2km/hr, W. Dir. 320° E of N, Precip. Rate 31.32 g/dm²/hr, Aircraft Orien. 190° E of N, F/P Orien. 310° E of N.

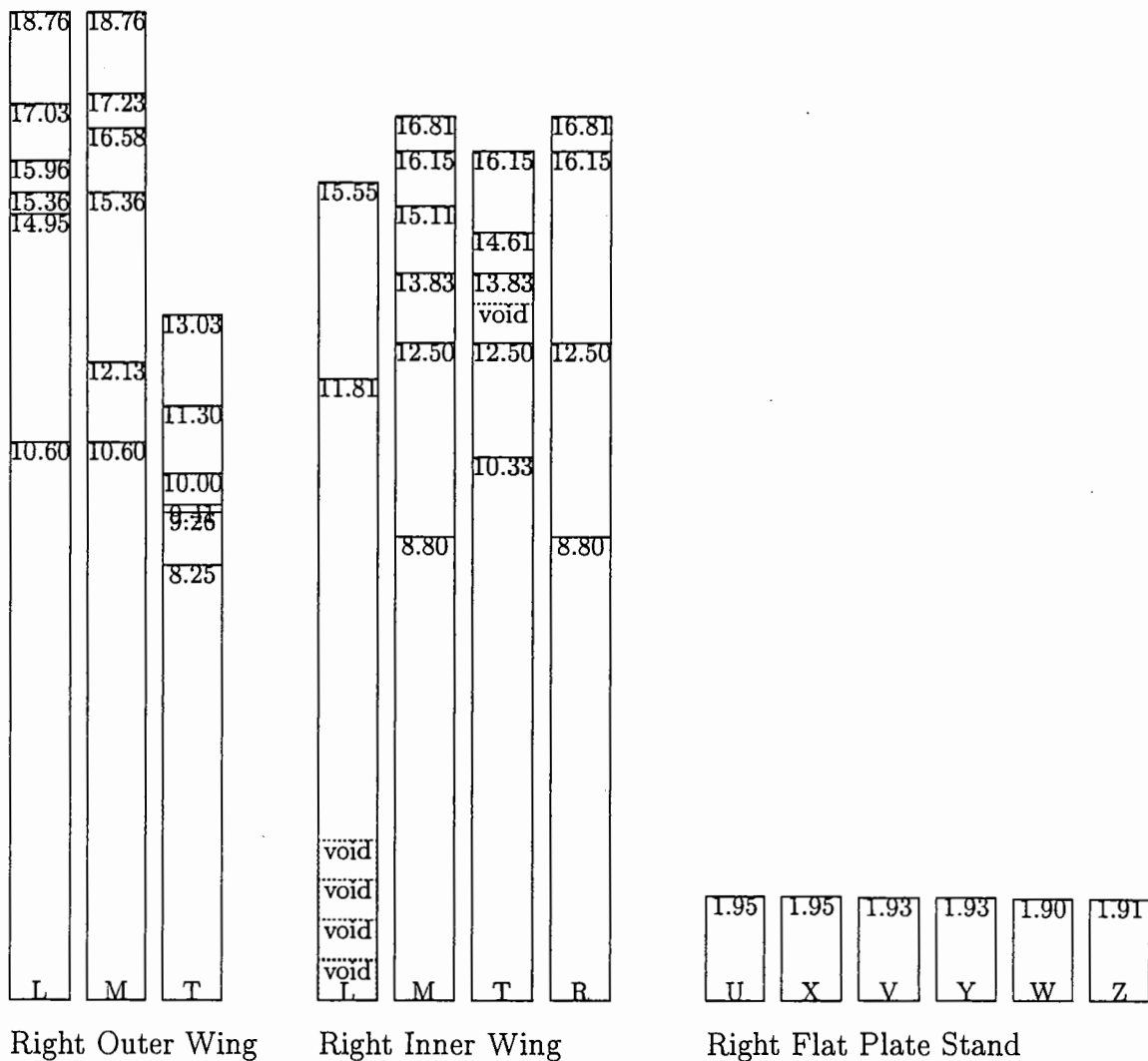

Figure 55: Test 5A Right - DC-9 Fluid Failure Observation Times: Amb. Tmp. -0.2°C , W. Spd. 35.2km/hr, W. Dir. 320° E of N, Precip. Rate $31.32 \text{ g/dm}^2/\text{hr}$, Aircraft Orien. 190° E of N, F/P Orien. 310° E of N.

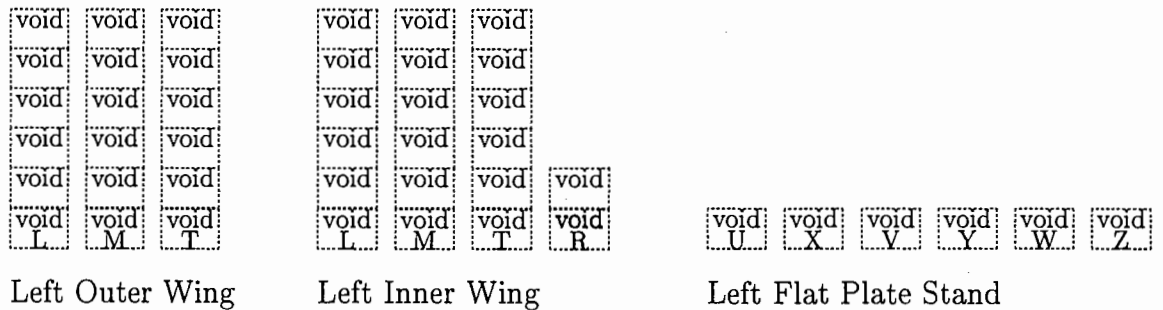

Figure 56: Test 5B Left - A320 Fluid Failure Observation Times: Amb. Tmp. 0.0°C, W. Spd. 37.04km/hr, W. Dir. 305° E of N, Precip. Rate N/A, Aircraft Orien. 190° E of N, F/P Orien. 300° E of N.

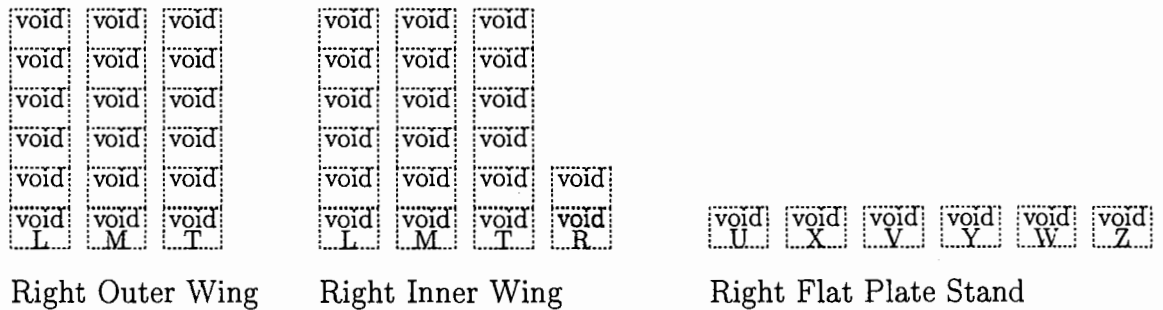

Figure 57: Test 5B Right - A320 Fluid Failure Observation Times: Amb. Tmp. 0.0°C, W. Spd. 37.04km/hr, W. Dir. 305° E of N, Precip. Rate N/A, Aircraft Orien. 190° E of N, F/P Orien. 300° E of N.

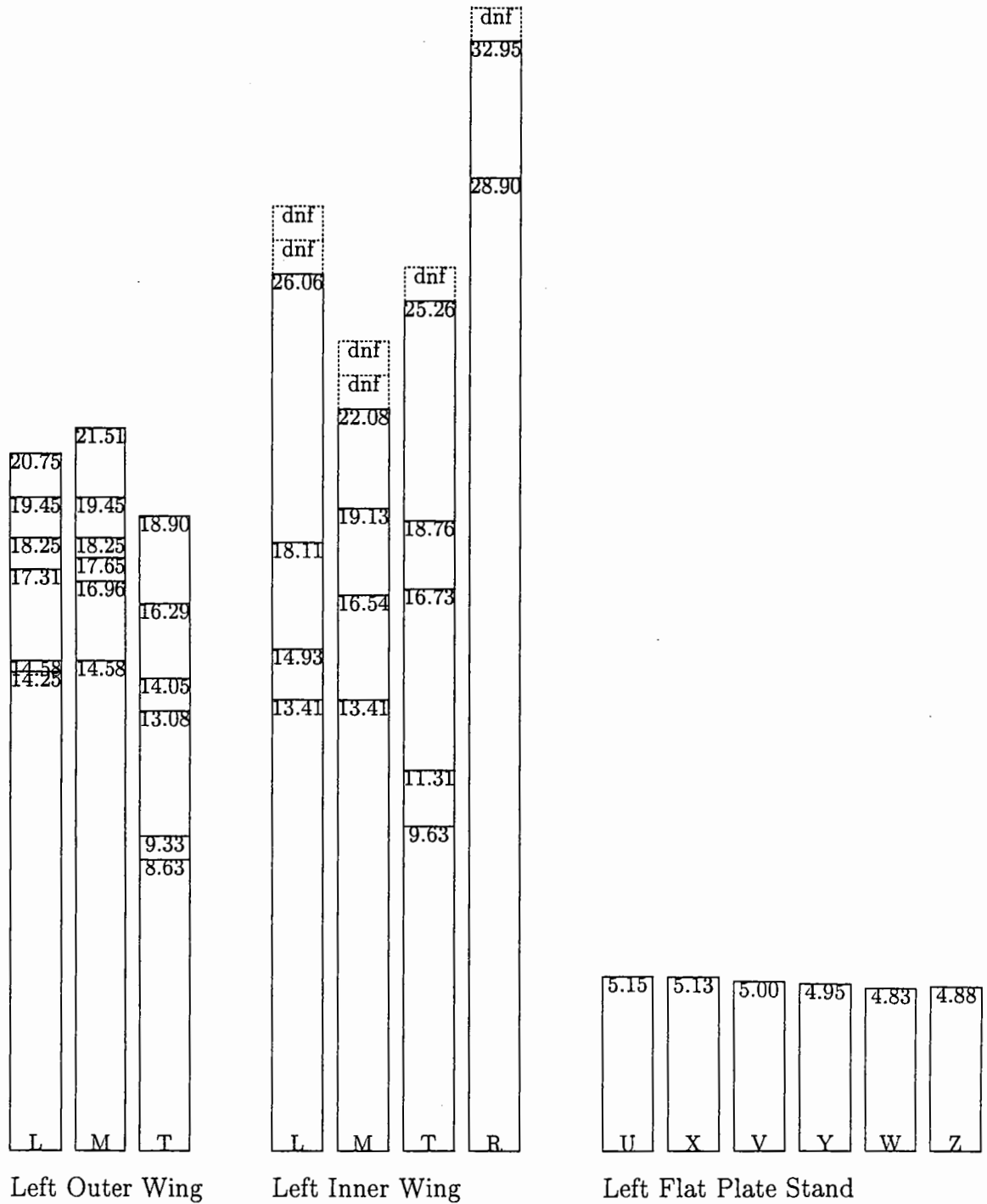

Figure 58: Test 5C Left - A320 Fluid Failure Observation Times: Amb. Tmp. 0.0°C, W. Spd. 38.9km/hr, W. Dir. 305° E of N, Precip. Rate 5.12 g/dm²/hr, Aircraft Orien. 190° E of N, F/P Orien. 300° E of N.

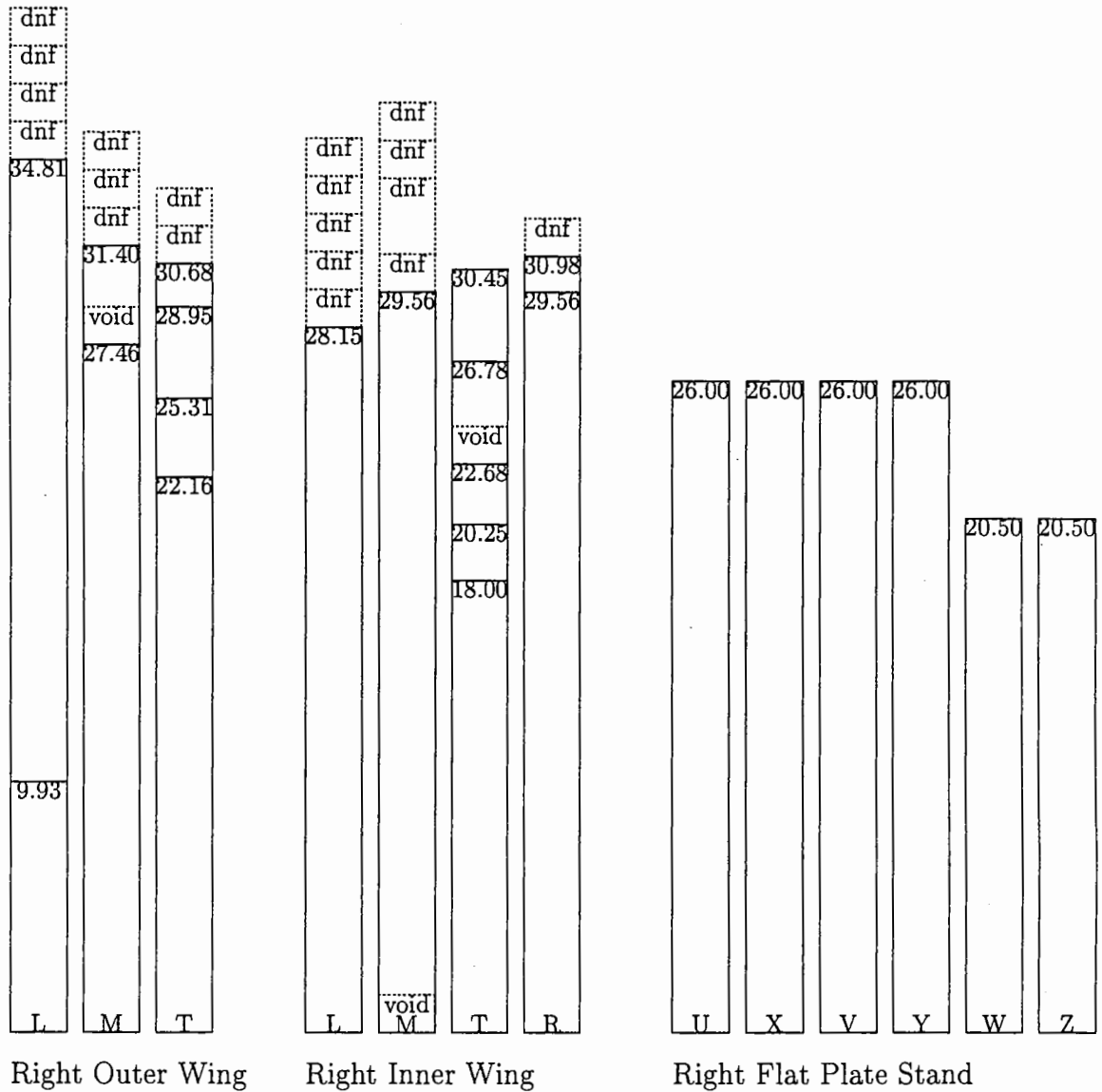

Figure 59: Test 5C Right - A320 Fluid Failure Observation Times: Amb. Tmp. 0.0°C, W. Spd. 38.9km/hr, W. Dir. 305° E of N, Precip. Rate 5.12 g/dm²/hr, Aircraft Orien. 190° E of N, F/P Orien. 300° E of N.

APPENDIX D
DETAILS OF THE AIRCRAFT WING TEMPERATURE
MEASUREMENTS DURING STATIC TESTS
AT ST. JOHN'S, NEWFOUNDLAND

Aircraft Wing Temperature Measurements

Appendix D details the aircraft wing temperature measurements obtained during the five static test evenings. The wing temperature data is recorded in table format and two tables are required per static test: one table for the right wing temperature measurements and one table for the left wing temperature measurements. Each temperature measurement contains three pieces of information:

1. Temperature: All temperature measurements are recorded in °C.
2. location: The location of the temperature measurement is based on the wing grid structure (refer to Figure 1). Figure 60 illustrates the aircraft wing site locations.
3. Time Stamp: The time stamp is recorded in the format hh:mm:ss.

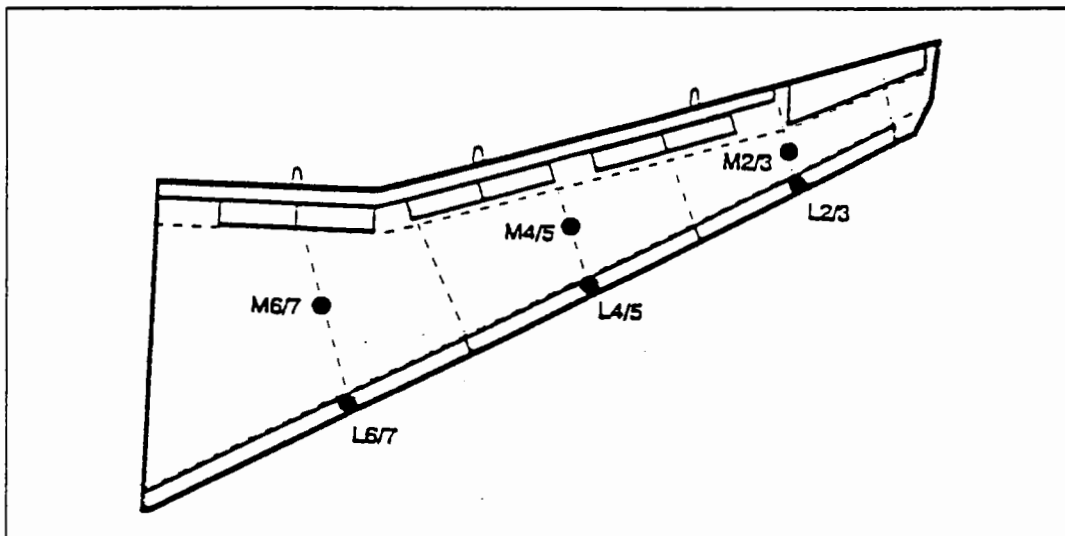

Figure 60: Aircraft Wing Temperature Measurement Locations.

The *before* entry in each table represents the temperature profile of the wing before de-icing. The *end* entry in each table represents the temperature profile of the aircraft wing after test termination.

Static tests 1 and 2 have wing temperature measurements before the de-icing and after test termination. Static tests 3, 4 and 5 contain aircraft wing measurements not only before the de-icing and after test termination but also inbetween. These inbetween measurements were obtained as often as possible.

Time (min)	Temperature[°C] at Location at Time[hh:mm:ss]					
	L2/3	M2/3	L4/5	M4/5	L6/7	M6/7
before	-6.0	-6.0	-6.0	-6.0	-5.0	-6.0
1:15:00	?	?	?	?	?	?
end	-7.2	-7.0	-7.0	-7.0	-7.1	-7.0
1:58:00	?	?	?	?	?	?

Table 26: Aircraft Right Wing Temperature Data: Static Test 1A.

Time (hh:mm:ss)	Temperature[°C] at Location at Time[hh:mm:ss]					
	L2/3	M2/3	L4/5	M4/5	L6/7	M6/7
before	-6.0	-6.0	-6.0	-6.0	-6.0	-6.0
1:18:00	?	?	?	?	?	?
end	-7.2	-7.1	-7.0	-7.0	-7.1	-6.9
2:00:00	?	?	?	?	?	?

Table 27: Aircraft Left Wing Temperature Data: Static Test 1A.

During the static tests, several problems existed which prevented a complete wing measurement. In these cases, a question mark(?) is inserted.

Time (hh:mm:ss)	Temperature[°C] at Location at Time[hh:mm:ss]					
	L2/3	M2/3	L4/5	M4/5	L6/7	M6/7
before	-7.2	-7.1	-7.0	-7.0	-7.1	-6.9
2:56:00	?	?	?	?	?	?
end	?	?	?	?	?	?
?	?	?	?	?	?	?

Table 28: Aircraft Right Wing Temperature Data: Static Test 1B.

Time (hh:mm:ss)	Temperature[°C] at Location at Time[hh:mm:ss]					
	L2/3	M2/3	L4/5	M4/5	L6/7	M6/7
before	-7.2	-7.0	-7.0	-7.0	-7.1	-7.0
2:52:00	?	?	?	?	?	?
end	?	?	?	?	?	?
?	?	?	?	?	?	?

Table 29: Aircraft Left Wing Temperature Data: Static Test 1B.

Time (hh:mm:ss)	Temperature[°C] at Location at Time[hh:mm:ss]					
	L2/3	M2/3	L4/5	M4/5	L6/7	M6/7
before	-4.4	-4.5	-4.3	-4.5	-4.6	-4.7
11:45:00	?	?	?	?	?	?
end	-5.9	-5.8	-5.7	-5.8	-5.6	-5.8
1:20:00	?	?	?	?	?	?

Table 30: Aircraft Right Wing Temperature Data: Static Test 2A.

Time (hh:mm:ss)	Temperature[°C] at Location at Time[hh:mm:ss]					
	L2/3	M2/3	L4/5	M4/5	L6/7	M6/7
before	-4.7	-4.7	-4.7	-4.6	-4.8	-4.9
11:40:00	?	?	?	?	?	?
end	-6.2	-6.2	-6.2	-6.2	-6.1	-6.2
1:25:00	?	?	?	?	?	?

Table 31: Aircraft Left Wing Temperature Data: Static Test 2A.

Time (hh:mm:ss)	Temperature[°C] at Location at Time[hh:mm:ss]					
	L2/3	M2/3	L4/5	M4/5	L6/7	M6/7
before	-6.4	-6.4	-6.0	-6.2	-6.3	-6.3
2:08:00	?	?	?	?	?	?
end	-6.4	-6.6	-6.4	-6.7	-6.6	-6.6
2:54:00	?	?	?	?	?	?

Table 32: Aircraft Right Wing Temperature Data: Static Test 2B.

Time (hh:mm:ss)	Temperature[°C] at Location at Time[hh:mm:ss]					
	L2/3	M2/3	L4/5	M4/5	L6/7	M6/7
before	-6.4	-6.6	-6.4	-6.6	-6.4	-6.4
2:14:00	?	?	?	?	?	?
end	-6.7	-6.8	-6.9	-6.9	-6.8	-6.9
2:59:00	?	?	?	?	?	?

Table 33: Aircraft Left Wing Temperature Data: Static Test 2B.

Time (hh:mm:ss)	Temperature[°C] at Location at Time[hh:mm:ss]					
	L2/3	M2/3	L4/5	M4/5	L6/7	M6/7
before	-6.4	-6.6	-6.4	-6.7	-6.6	-6.6
2:54:00	?	?	?	?	?	?
end	-5.9	-6.3	-5.7	-6.1	-6.1	-6.6
3:58:00	?	?	?	?	?	?

Table 34: Aircraft Right Wing Temperature Data: Static Test 2C.

Time (hh:mm:ss)	Temperature[°C] at Location at Time[hh:mm:ss]					
	L2/3	M2/3	L4/5	M4/5	L6/7	M6/7
before	-6.7	-6.5	-6.7	-6.9	-6.8	-6.9
2:59:00	?	?	?	?	?	?
end	-6.6	-7.0	-6.6	-7.1	-6.7	-6.7
4:03:00	?	?	?	?	?	?

Table 35: Aircraft Left Wing Temperature Data: Static Test 2C.

Time (hh:mm:ss)	Temperature[°C] at Location at Time[hh:mm:ss]					
	L2/3	M2/3	L4/5	M4/5	L6/7	M6/7
before	-5.0	-4.5	-4.6	-4.7	-5.9	-5.8
1:55:00	?	?	?	?	?	2:00:00
2:20:00	14.0	4.0	1.0	3.0	-1.0	-2.0
	?	?	?	2:23:00	?	2:24:00
2:32:24	-5.0	-5.1	-5.9	-4.5	-6.3	-4.9
	?	?	5.9	2:34:30	2:35:20	2:36:10
end 2:42:00	-6.3	-6.3	-6.3	-6.1	-6.1	-6.0
	?	2:43:00	?	2:44:56	2:45:29	?

Table 36: Aircraft Right Wing Temperature Data: Static Test 3A.

Time (hh:mm:ss)	Temperature[°C] at Location at Time[hh:mm:ss]					
	L2/3	M2/3	L4/5	M4/5	L6/7	M6/7
before	-5.7	-6.0	-5.8	-6.0	-5.8	-6.0
2:05:00	?	?	?	?	?	2:07:00
2:25:00	-3.5	0.0	-2.0	-2.4	-4.8	?
	2:26:00		2:28:00	2:29:30	?	?
end 2:37:00	-6.2	-7.0	-6.5	-6.6	-6.4	-6.4
	2:38:00	?	2:39:50	2:40:30	?	2:41:00

Table 37: Aircraft Left Wing Temperature Data: Static Test 3A.

Time (hh:mm:ss)	Temperature[°C] at Location at Time[hh:mm:ss]					
	L2/3	M2/3	L4/5	M4/5	L6/7	M6/7
before 3:00:00	?	-5.8	-5.9	-6.0	-6.0	-6.0
	?	3:01:10	?	3:02:25	?	3:03:39
?	-0.7	?	?	?	-2.0	-2.9
	?	?	?	?	3:15:01	3:15:44
end 3:21:00	-5.2	-5.8	?	-4.8	-5.7	-5.4
	3:21:55	3:22:42	?	3:24:07	3:24:41	3:25:14

Table 38: Aircraft Right Wing Temperature Data: Static Test 3B.

Time (hh:mm:ss)	Temperature[°C] at Location at Time[hh:mm:ss]					
	L2/3	M2/3	L4/5	M4/5	L6/7	M6/7
before 3:05:00	-6.2	-6.3	-6.2	-6.3	-6.2	-6.2
	3:06:00	?	3:07:15	3:07:50	?	3:08:48
	0.0	-1.3	-2.0	-0.5	-4.0	-4.9
3:17:00	3:17:10	3:17:30	3:18:11	3:18:54	3:19:30	3:20:37
end 3:26:45	-4.9	-6.2	-5.4	-5.5	-5.7	-4.2
	3:26:45	3:27:19	3:27:45	3:28:20	3:29:01	3:29:52

Table 39: Aircraft Left Wing Temperature Data: Static Test 3B.

Time (hh:mm:ss)	Temperature[°C] at Location at Time[hh:mm:ss]					
	L2/3	M2/3	L4/5	M4/5	L6/7	M6/7
before 3:36:54	-5.9	-5.8	-5.8	-5.7	-5.7	-5.0
	3:36:54	3:38:05	3:38:45	3:39:14	3:40:25	?
	?	?	5.6	?	?	?
?	?	?	3:46:23	?	?	?
end 3:56:00	-5.1	-4.2	-5.1	-4.5	-5.?	?
	3:56:27	3:56:55	3:57:37	3:58:05	3:58:41	3:59:09

Table 40: Aircraft Right Wing Temperature Data: Static Test 3C.

Time (hh:mm:ss)	Temperature[°C] at Location at Time[hh:mm:ss]					
	L2/3	M2/3	L4/5	M4/5	L6/7	M6/7
before 3:41:56	?	-5.9	-5.8	-5.?	-5.8	-5.6
	?	?	?	?	3:43:21	3:43:47
	1.7	-0.5	?	?	?	?
?	3:49:49	3:53:11	?	?	?	?
end 4:00:00	-4.8	-5.7	-5.2	-5.6	-5.2	-4.?
	4:00:21	4:00:45	4:01:19	4:01:47	4:02:22	4:02:50

Table 41: Aircraft Left Wing Temperature Data: Static Test 3C.

Time (hh:mm:ss)	Temperature[°C] at Location at Time[hh:mm:ss]					
	L2/3	M2/3	L4/5	M4/5	L6/7	M6/7
before	-5.6	-5.5	-5.4	-5.4	-5.4	-5.2
4:11:22	4:11:25	4:12:07	4:12:41	4:13:04	4:13:34	4:14:00
	0.0	-2.0	-1.3	-2.9	0.5	0.3
4:19:09	4:19:09	4:19:30	4:20:13	4:20:44	4:21:25	4:21:49
	-4.3	-2.5	-4.4	-4.5	-3.6	-2.7
4:26:53	4:26:53	4:27:26	4:28:05	4:28:35	4:29:22	4:29:54
end	-5.3	-5.5	-5.3	?	?	?
4:35:25	4:35:25	4:35:52	?	?	?	?

Table 42: Aircraft Right Wing Temperature Data: Static Test 3D.

Time (hh:mm:ss)	Temperature[°C] at Location at Time[hh:mm:ss]					
	L2/3	M2/3	L4/5	M4/5	L6/7	M6/7
before	-5.5	-5.8	-5.7	-5.7	-5.5	-5.4
4:15:20	4:15:25	4:15:53	4:16:29	4:16:50	4:17:27	4:17:52
	-5.4	-0.3	-4.9	-3.9	-1.5	-1.0
4:23:00	4:23:00	4:23:32	4:24:09	4:24:33	4:25:07	4:25:30
	-5.3	-4.1	-5.2	-5.8	-4.7	-3.5
?	?	4:31:56	4:32:38	4:33:05	4:33:44	4:34:13
end	?	?	?	?	?	?
?	?	?	?	?	?	?

Table 43: Aircraft Left Wing Temperature Data: Static Test 3D.

Time (hh:mm:ss)	Temperature[°C] at Location at Time[hh:mm:ss]					
	L2/3	M2/3	L4/5	M4/5	L6/7	M6/7
before	-2.1	-2.0	-1.8	-1.8	-1.8	-2.1
12:32:26	12:32:26	12:33:49	12:36:07	12:37:21	12:38:24	12:40:35
end	?	?	?	?	?	?
?	?	?	?	?	?	?

Table 44: Aircraft Right Wing Temperature Data: Static Test 4A.

Time (hh:mm:ss)	Temperature[°C] at Location at Time[hh:mm:ss]					
	L2/3	M2/3	L4/5	M4/5	L6/7	M6/7
before	-1.0	-1.7	-1.3	-1.7	-1.8	-1.7
12:46:11	12:46:11	12:47:57	12:50:14	12:51:32	12:53:35	12:54:45
end	?	?	?	?	?	?
?	?	?	?	?	?	?

Table 45: Aircraft Left Wing Temperature Data: Static Test 4A.

Time (hh:mm:ss)	Temperature[°C] at Location at Time[hh:mm:ss]					
	L2/3	M2/3	L4/5	M4/5	L6/7	M6/7
before	?	?	0.0	-0.1	-0.4	-0.6
1:25:00	?	?	?	?	?	?
1:48:00	0.7	9.4	3.0	?	-1.4	-2.1
	?	?	?	?	?	?
?	0.0	-0.3	?	?	?	?
	?	?	?	?	?	?
2:11:00	0.0	0.0	-0.8	-1.4	-1.4	-1.9
	?	?	?	?	?	?
end	?	?	?	?	?	?
?	?	?	?	?	?	?

Table 46: Aircraft Right Wing Temperature Data: Static Test 5A.

Time (hh:mm:ss)	Temperature[°C] at Location at Time[hh:mm:ss]					
	L2/3	M2/3	L4/5	M4/5	L6/7	M6/7
before 1:32:00	-0.3	-0.4	-0.5	-0.6	-0.4	-0.6
	?	?	?	?	?	?
1:54:00	1.7	0.8	-0.7	0.9	0.2	0.7
	?	?	?	?	?	?
2:05:00	-0.8	-1.5	-1.4	-1.7	-1.0	-1.0
	?	?	?	?	?	?
2:16:00	-1.2	-1.5	-1.2	-1.4	-1.0	-1.2
	?	?	?	?	?	?
end ?	?	?	?	?	?	?
	?	?	?	?	?	?

Table 47: Aircraft Left Wing Temperature Data: Static Test 5A.

Time (hh:mm:ss)	Temperature[°C] at Location at Time[hh:mm:ss]					
	L2/3	M2/3	L4/5	M4/5	L6/7	M6/7
before 2:30:00	?	-0.7	-0.7	-1.3	-0.7	?
	?	?	?	?	?	?
3:10:00	?	?	?	?	?	?
	?	?	?	?	?	?
3:19:00	?	?	?	?	?	?
	?	?	?	?	?	?
3:38:00	?	-0.3	-0.?	?	-0.1	-0.1
	?	?	?	?	?	?
4:30:00	?	-0.5	-0.5	?	-0.6	-0.6
	?	?	?	?	?	?
end ?	?	?	?	?	?	?
	?	?	?	?	?	?

Table 48: Aircraft Right Wing Temperature Data: Static Test 5B.

Time (hh:mm:ss)	Temperature[°C] at Location at Time[hh:mm:ss]					
	L2/3	M2/3	L4/5	M4/5	L6/7	M6/7
before 2:35:00	-0.7	?	-0.8	?	-0.8	-1.5
	?	?	?	?	?	?
3:17:00	1.5	?	1.9	?	1.4	?
	?	?	?	?	?	?
?	0.0	?	0.3	?	0.4	?
	?	?	?	?	?	?
3:44:00	-0.3	?	-0.3	?	0.2	?
	?	?	?	?	?	?
4:32:00	-0.6	?	-0.7	?	-0.3	-0.3
	?	?	?	?	?	?
end ?	?	?	?	?	?	?
	?	?	?	?	?	?

Table 49: Aircraft Left Wing Temperature Data: Static Test 5B.

Time (hh:mm:ss)	Temperature[°C] at Location at Time[hh:mm:ss]					
	L2/3	M2/3	L4/5	M4/5	L6/7	M6/7
before 4:30:00	?	-0.5	-0.5	?	-0.6	-0.6
	?	?	?	?	?	?
4:40:00	?	?	?	?	-0.1	-0.?
	?	?	?	?	?	?
4:52:00	?	?	?	?	-0.9	-1.2
	?	?	?	?	?	?
5:02:00	?	?	-0.3	?	-1.?	?
	?	?	?	?	?	?
5:20:00	?	?	?	?	-1.?	?
	?	?	?	?	?	?
end ?	?	?	?	?	?	?
	?	?	?	?	?	?

Table 50: Aircraft Right Wing Temperature Data: Static Test 5C.

Time (hh:mm:ss)	Temperature[°C] at Location at Time[hh:mm:ss]					
	L2/3	M2/3	L4/5	M4/5	L6/7	M6/7
before 4:32:00	-0.6	?	-0.7	?	-0.3	-0.3
	?	?	?	?	?	?
4:42:00	1.0	?	?	?	?	?
	?	?	?	?	?	?
4:55:00	-0.3	?	?	?	0.6	?
	?	?	?	?	?	?
5:09:00	-0.7	?	-0.7	?	0.0	?
	?	?	?	?	?	?
5:24:00	?	?	?	-0.7	?	?
	?	?	?	?	?	?
end ?	?	?	?	?	?	?
	?	?	?	?	?	?

Table 51: Aircraft Left Wing Temperature Data: Static Test 5C.

APPENDIX E
TERMS OF REFERENCE - WORK STATEMENT

WORK STATEMENT

**AIRCRAFT AND FLUID HOLDOVER TIME TESTS FOR WINTER 94/95
(Short Title: Winter Tests 94/95)****1 INTRODUCTION**

The recommendations of the Dryden Inquiry in March 1992 and the setting up of the Dryden Commission Implementation Project Office (DCIP), were followed almost immediately by the La Guardia crash of a F-28, also in March 1992. This accident also had clear implications that ice on take-off was involved. As a result the FAA introduced Holdover Time regulations and requested that the SAE Committee on Aircraft Ground Deicing spearhead work on establishing holdover guidelines. This led to the formation of the holdover time working group, co-chaired by DCIP and FAA/ARC. A major test program was initiated building on an existing program which had been initiated by the Transport Development Centre (TDC) for the 90/91 winter season.

Transport Canada (DCIP) agreed to coordinate the expanded test program, and provide several Instrumar Clean Wing Detection Systems (CWDS) sensor units to be used at selected sites as a measure to better define fluid failure criteria.

Times given in Holdover Time Tables were established by European Airlines based on assumptions of fluid properties, and anecdotal data. The extensive testing conducted by DCIP has been to determine the performance of fluids on standard flat plates in order to substantiate the times, or if warranted, to recommend changes. The original DCIP program has been largely completed, however as a result of the program findings DCIP has agreed with the SAE to extend the Table coverage to the low temperatures encountered in North American operations, to substantiate Table values for 'rain on a cold soaked wing', and to consider a new class of 'longer life' fluids. These latter fluids presently qualify as Type II, but preliminary data suggests that their very long times to failure, under certain circumstances, might warrant a new classification to permit the Airlines to benefit accordingly. Finally the flat plate data has not, to date, been correlated with fluid performance on service aircraft on a systematic basis.

Canadian Airlines International Ltd. (CAI), and Air Canada have offered to cooperate with DCIP in order to promote winter operational safety by making aircraft and limited ground support staff available to facilitate the correlation of flat plate data with performance of fluids on aircraft.

DCIP plans to take advantage of these offers to undertake the outstanding Holdover Time work, and with crew and equipment mobilized, to 'piggy-back' additional tests:

To evaluate the suitability of hot air for de-icing as an alternative to heated de-icing fluids at low (e.g. -30°C and below) ambient temperatures. The hot air temperature must not exceed 85°C ; time to de-ice, avoidance of re-freezing, and operational economics are factors to be considered. Similarly forced air will also be considered for removal of cold dry snow, and for 'warm' wet snow.

Use of hot water is presently permitted for de-icing down to -3°C . Past experience suggests that this could be extended to -7°C , or lower, though no quantitative data is available. The economic and environmental advantages are self-evident. Pertinent tests will therefore be conducted to address the effectiveness of hot (up to 85°C) water with consideration given not only to the de-icing operation proper, but also to the problem of ice formation on the ground.

Since instrumentation will be used to determine fluid failure on the aircraft the role and application of such instrumentation within the regulatory environment will be studied.

2 PROGRAM OBJECTIVE (MCR 16)

Take an active and participatory role to advance aircraft ground de-icing/anti-icing technology. Develop international standards, guidance material for remote and runway-end de-icing facilities, and more reliable methods of predicting de-icing/anti-icing hold-over times.

3 PROGRAM SUB-OBJECTIVES

Perform tests to record data which will subsequently be used to establish relationships between laboratory testing and real world experience in protecting aircraft surfaces. Develop reliable holdover time (HOT) guideline material based on test information for a wide range of winter weather operating conditions. Substantiate values in existing holdover time tables for type 1, type 2, and possibly type 3 fluids.

4 PROJECT OBJECTIVES

- 4.1 To complete the substantiation of the existing SAE HoldOver Time Tables and proposed Table extensions by conduct of tests on modified 'standard' flat plates, adapted to provide reference conditions for 'cold soaked' wings, for Type I and Type II fluids subjected to a controlled environment of rain.**
- 4.2 To complete the substantiation of the existing SAE holdover time Tables and proposed table extensions by conduct of tests on standard flat plates as follows:**
 - Type I and Type II fluids under conditions of natural snow, freezing drizzle and simulated freezing fog and freezing drizzle at the lowest temperature ranges for each condition of precipitation.**
 - Type I fluids at dilutions for which a buffer of 10° C from the fluid freeze point is maintained.**
 - At least two samples of a new family of 'long-life' fluids will be tested to establish the holdover times over the full range of HOT table conditions for this potential new fluids category.**
- 4.3 To correlate the flat plate test data used to substantiate the SAE HoldOver Time Tables with the performance of fluids on service aircraft, by concurrently testing de/anti-icing fluids on standard flat plates and service aircraft under conditions of natural freezing precipitation for Type I and Type II fluids during the 94/95 winter season.**
- 4.4 To evaluate the suitability of hot air de-icing at low ambient temperatures as an alternative to heated de-icing fluids, and to evaluate the suitability of heated or unheated forced air for removal of cold dry snow, and/or wet snow.**
- 4.5 To ascertain the environmental limits for the use of hot water as a de-icing fluid.**
- 4.6 To evaluate a remote sensor as an inspection device to detect contamination, under field conditions.**
- 4.7 To determine the pattern of fluid run-off from the wing during take-off.**

5. DETAILED STATEMENT OF WORK

The work shall be broken down into 7 distinct areas of activity consistent with the project objectives, together with activities for presentations and reporting at the completion of work. A detailed workplan, activity schedule, cash flow projection, project management control and documentation procedure shall be developed and delivered to the DCIP R&D Task Group project officer for approval within one week of effective start date.

5.1 "Cold soak" Test Program

5.1.1 Develop an experimental plan, prepare experiments, conduct tests, analyse results and prepare report for a program to substantiate the values given in the SAE HoldOver Time Tables for diluted and undiluted Type I and Type II fluids for "Rain on a Cold Soaked Wing".

5.1.2 Conduct tests at the Climatic Engineering Facility (CEF), of the National Research Council, Ottawa.

5.1.3 Supply all necessary equipment and fluids for conduct of the tests. This shall include a cooling system to maintain the test plate at constant temperature during the tests.

5.1.4 Schedule an array of tests, for review and approval by the DCIP project officer, covering a range of environmental temperatures from 0°C to +7°C, a range of plate temperatures from 0°C to -15°C, and a range of precipitation rates to be determined in consultation with personnel from AES and NRC. Coordinate the range of plate temperatures with data to be made available by DCIP from field measurements of wing temperatures on service aircraft.

5.1.5 Coordinate scheduling of tests with NRC. Give advance notice of all intended tests to DCIP project officer. Duration of tests shall be 5 working days, including set-up time. Complete tests no later than 31 March 1995.

5.2 Substantiation of HOT Tables

5.2.1 Develop experimental programs, for review and approval by the DCIP project officer, for testing of Type I fluids over the entire range of conditions covered by the HOT Tables. Test fluids at dilutions for which a buffer of 10° C from the fluid freeze point is maintained. These programs shall include outside testing under conditions of natural precipitation, and laboratory testing in the NRC CEF for tests involving freezing fog and freezing drizzle.

5.2.2 Develop test programs for each applicable condition of precipitation, as specified by the SAE HOT Tables, for review and approval by the DCIP project officer:

(a) For testing of undiluted Type II fluids under conditions of natural snow and freezing drizzle at the lowest temperature ranges (i.e. below -14°C).

(b) For testing of Type II fluids under conditions of simulated freezing fog and freezing drizzle at the lowest temperature ranges.

5.2.3 Develop a test program to test undiluted samples representative of the new 'long-life' fluids to establish holdover times over the full range of HOT table conditions for this potential new fluids category. Obtain samples from fluids producers. Conduct tests during periods of freezing precipitation concurrent with HOT Table substantiation tests of conventional fluids.

5.2.4 Establish a test site at Montreal, Dorval Airport for conduct of outside tests. Provide support services and appropriate facilities. Recruit and train local personnel. Repair and replace, as necessary, DCIP supplied equipment used for previous years' testing.

5.2.5 Conduct tests with simulated freezing fog and freezing drizzle in the NRC CEF facility, Ottawa. Provide materials and equipment necessary for tests, conduct tests, analyse results and report. Coordinate scheduling of tests with NRC. Give advance notice of all intended tests to DCIP R&D project officer. Duration of tests shall be 5 working days, including set-up time, and tests shall be completed no later than 31 March 1995.

5.2.6 Determine fluid failure by use of Instrumar C-FIMS instrument installed in at least one plate, by RVS1 remote sensor set up to view a 'stand' of six standard test plates, and by visual observation.

5.2.7 Conduct ancilliary tests during outside tests at Dorval to collect visibility data during periods of freezing precipitation, and correlate measurements with concurrent meteorological data: precipitation rate, precipitation type, temperature, wind velocity and direction; and background lighting condition as appropriate. An NRC 'WIVIS' Visibility meter shall be obtained from AES in Toronto, where it will be calibrated, during early January 1995.

5.2.8 Program results and plans for completion shall be subject to a 'mid-term' review to be called by DCIP.

5.2.9 Videotape tests. Collect, analyse and report test results.

5.3 Correlation of performance of fluids on flat plates with performance on aircraft

Note: Availability of aircraft will be negotiated by DCIP. In general aircraft will be made available for testing outside regular service hours i.e. available between 11:00 hrs. and 06:00 hrs. Aircraft types to be used will be representative of those in common use by airlines in Canada. Test programs will be conducted at Toronto, Pearson international Airport, using aircraft made available by Canadian International Airlines Ltd. (CAI); at Montreal, Dorval International Airport, using aircraft made available by Air Canada; and in St. John's International Airport, Newfoundland using aircraft to be negotiated.

5.3.1 Develop experimental programs, for review and approval by the DCIP project officer, for concurrent comparison testing of Type I and Type II fluids under conditions of natural freezing precipitation on flat plates and on aircraft. Present the approved programs to the airlines involved prior to start of field tests.

5.3.2 Recruit and train local personnel who will conduct test work. Organize and conduct a 'Kick-off' meeting at each test site with all parties involved in the provision of services and conduct of tests .

5.3.3 Provide all fluids, equipment, an RVSI remote sensor, and all other instrumentation necessary for conduct of tests and recording of data. Ancilliary equipment shall include lighting fixtures as necessary, observation platforms, vehicles, storage facilities, office facilities and personnel rest accomodation for self-contained operations. Secure necessary approvals and passes for personnel and vehicle access and operation on airport airside property. Limit the number of personnel on site to the minimum necessary for execution of test programs: not more than eight persons under normal conditions, not more than ten persons maximum. Co-ordinate with all agencies involved to ensure that these limits are respected.

5.3.4 Include one 'dry run' at each test location prior to start of field tests, under conditions without precipitation, to ensure correct execution of tasks, simulated collection of all data required, and smooth co-ordination of functions.

5.3.5 Schedule tests to determine the comparative performance of Type I and Type II fluids on standard flat plates and aircraft on the basis of forecast significant-duration night-time periods of freezing precipitation. Give advance notice to the airline of the desired test set-up including aircraft orientation to the forecast wind direction, sequence of fluid applications, and

any additional services requested. Fluids to be tested shall be from the range of fluids normally used by the airline. Application of different fluids may be requested for each wing in order to maximize test data. Application of fluids will be by airline personnel.

Record pattern of fluid failure. Record effect of aircraft orientation to wind as a variable over the series of tests conducted. The aircraft will in general not be re-oriented during conduct of a test.

5.3.6 Proposed test programs shall assume conduct of five (5) all night test sessions, subject to weather conditions. Additional tests may be requested subject to agreement by all parties involved. Perform tests following plans based on the following:

- A detailed statement of work for each of the participants.
- A specific plan of tests, for review by all parties, which shall include as a minimum:
 - schedule and sequence of activities
 - detailed list of responsibilities
 - complete equipment list
 - list of data, measurements, and observations to be recorded
 - detailed test procedures.
- Activities including:
 - Visual and Instrumented Data Logging.
 - Monitoring and recording environmental conditions, including:
 - air temperature
 - Wing surface temperature at selected locations
 - wind velocity and direction
 - precipitation type and rate
 - Record of Aircraft and Plate orientation to the wind.
 - Use of Instrumentation to determine condition of the fluid.
- Detailed and rigorous experimental procedures
- Acquisition of data from the tests to address:-
 - Identification of fluid failure criteria.
 - Location of first point of fluid failure on wing, and subsequent failure progression
 - Correlation of fluid failure time to environmental conditions.
 - Correlation of fluid failure times: flat plates and aircraft.
 - Behaviour of fluid on the 'representative' surface.

5.3.7 Anticipate availability at PIA, Toronto, of a Boeing 737 aircraft presently planned to be fitted with Allied Signal C-FIMS contamination sensors on the 'representative' surfaces. Incorporate data available from these sensors into the overall test results. Coordinate data collection activities with Allied Signal. Support visual observations, video records, and

C-FIMS records of fluids behaviour with output from the RVSI remote sensor.

5.3.8 Any equipment obtained from airlines for use during tests shall be returned to its original condition at the end of the test program.

5.3.9 Videotape records of all tests shall be made.

5.4 Forced Air as a de-icing and/or snow removal agent

Note: Hot air is not presently used for de-icing. Criteria for use will be availability of equipment/capital cost, time to de-ice, assurance that all frozen contamination is removed (re-freezing of melted precipitate does not occur), and overall cost effectiveness. Form of initial contamination may be a significant factor.

5.4.1 Conduct a preliminary overview to identify equipment potentially suitable for removal of frost at low (-33°C and lower) temperatures by hot air, and for removal of dry snow and/or wet snow by blown air. Review candidate technologies with personnel of DCIP and the participating Airlines.

5.4.2 Develop experimental programs, for review and approval by the DCIP project officer, for testing of the recommended technology(ies). A test location at Montreal Dorval Airport is anticipated. Recommend alternative test location(s) as appropriate. Arrange for availability of recommended equipment.

5.4.3 Establish test site(s) for conduct of tests. Review truck to be made available by CAIL as a potential mounting platform. Application of blown air will be by airline personnel. Provide support services and appropriate facilities. Recruit and train local personnel as necessary.

5.4.4 Schedule field tests on the basis of forecast weather conditions and plan and co-ordinate test activities in conjunction with airline personnel. Conduct tests under appropriate weather and contamination conditions:

- Aircraft with frost at -33°C or colder.
- Aircraft with accumulated cold dry snow at temperatures below 0°C
- Aircraft with accumulated wet snow at temperatures close to 0°C

5.4.5 Maintain a videotape record of tests. Collect analyse and report test results.

5.5 Hot Water as a de-icing agent

Note: Hot water has been in use as a de-icing agent for many years. Present restrictions limit its use to a minimum ambient air temperature of -3°C . Spent hot water run-off onto a cold-soaked de-icing pad surface will give rise to surface icing/hazards to operators. No anti-icing protection is afforded other than temperature rise of aircraft surfaces above 0°C . Substantiated limits to hot water use are not known. A test location at Montreal Dorval Airport is anticipated for work in conjunction with Air Canada.

5.5.1 Develop a test program to determine the minimum ambient (air and ground) temperature conditions under which hot water can be used for de-icing, for review and approval by the DCIP project officer and Air Canada.

5.5.2 Establish a test site at Montreal, Dorval Airport for conduct of tests. Application of blown air will be by airline personnel. Provide support services and appropriate facilities. Recruit and train local personnel as necessary.

5.5.3 Plan and co-ordinate field tests in conjunction with airline personnel on the basis of forecast weather conditions.

5.5.4 Maintain a video record of conduct of tests. Collect analyse and report test results.

5.6 The remote sensor as an inspection device to detect contamination, under field conditions.

Note: The ability of the RVSI sensor to detect and identify fluid failure on flat plates when exposed to freezing precipitation under field conditions was demonstrated during winter 1994/95. The technological application of the remote sensor, to be procured and installed in support of tests to ascertain the correlation of performance of fluids on flat plates with performance on aircraft, is still under development for application to aircraft inspection.

5.6.1 Develop an experimental program, for review and approval by the DCIP project officer, to verify in the NRC CEF cold chamber over a temperature range down to -30°C the performance and suitability of the sensor.

5.6.2 Develop an experimental program, for review and approval by the DCIP project officer, to verify the performance and suitability of the sensor for field use. Conditions to be examined shall include effect of background

lighting; desirable distance of sensor from the wing surface and effective field of view; identification of the zone of the wing under inspection; potential need for scanning; and effects of meteorological conditions and presence of de/anti-icing fluids.

5.6.3 Define equipment requirements and design modifications necessary for mounting the sensor for field use.

5.6.4 Maintain a record of sensor video output with reference data. Collect, analyse and report test results.

5.7 The pattern of fluid run-off from the wing during take-off.

5.7.1 Arrange for de-icing/anti-icing the Boeing 737 aircraft using undiluted fluids during a period of without precipitation in the event that the C-FIMS sensors are installed. Record meteorological conditions; and thickness history of the fluid on each sensor from time of application to take-off, and after take-off if relevant and possible.

5.8 Presentations of test program results

5.8.1 Prepare and present preliminary findings of test programs involving field tests with aircraft to representatives of Transport Canada and the Airlines involved at end of the test season, but no later than April 30 1995.

5.8.2 Prepare and present, in conjunction with Transport Canada personnel, winter test program results at SAE G-12 Committee meetings in Chicago, and London, England.

5.9 Reporting

Reporting shall be in accordance with section 10 "Reporting", below.

5.9.1 Substantiation of HoldOver Time Tables

A final report shall be prepared covering all winter testing sponsored by TDC and DCIP, including that from previous winters, conducted to substantiate the SAE HOT Tables.

5.9.2 Reporting of Other Testing

Separate final reports shall be issued for each area of activity consistent with the project objectives.