



# **Enabling Accessibility Fund**



## **Flat Rate Information 2023-2024**

**Enabling Accessibility Fund: Flat Rate Information – 2023-2024**

Large print, braille, MP3 (audio), e-text and DAISY formats are available on demand by [ordering online](#) or calling 1 800 0-Canada (1-800-622-6232). If you use a teletypewriter (TTY), call 1-800-926-9105.

© His Majesty the King in Right of Canada, 2023

For information regarding reproduction rights: [droitdauteur.copyright@HRSDC-RHDCC.gc.ca](mailto:droitdauteur.copyright@HRSDC-RHDCC.gc.ca).

**PDF**

Cat. No.: Em12-80/2023E-PDF

ISBN: 978-0-660-67698-2

Dimensions and standard requirements outlined in diagrams are based on the National Building Code (NBC) 2015 with precedent from the Canada Standards Association (CSA) standards. Contact your Local Authority Having Jurisdiction and local and municipal building codes for local standards. Exact standards and requirements as they relate to acceptable building code solutions vary between provinces, cities and municipalities. Diagrams are shown for reference only and should be applied only as a suggestion to the acceptable construction methods to meet the intent of the building code.

With the permission of Canadian Standards Association, (operating as “CSA Group”), 178 Rexdale Blvd., Toronto, ON, M9W 1R3, material is reproduced from CSA Group’s standard **CSA/ASC B651:23, *Accessible design for the built environment***. This material is not the complete and official position of CSA Group on the referenced subject, which is represented solely by the Standard in its entirety. While use of the material has been authorized, CSA Group is not responsible for the manner in which the data is presented, nor for any representations and interpretations. No further reproduction is permitted. For more information or to purchase standard(s) from CSA Group, please visit [store.csagroup.org](https://store.csagroup.org) or call 1-800-463-6727.



# Table of Contents

---

<b>List of figures</b> .....	<b>3</b>
<b>Flat rate description for construction projects</b> .....	<b>4</b>
<b>How do flat rate costs work</b> .....	<b>4</b>
<b>How will project location impact funding amounts</b> .....	<b>4</b>
<b>Project planning and contingency</b> .....	<b>5</b>
<b>Ramps</b> .....	<b>6</b>
Figure 1: Ramps .....	6
<b>Accessible doors</b> .....	<b>8</b>
Figure 2: Accessible doors .....	8
<b>Accessible washrooms</b> .....	<b>10</b>
Figure 3: Accessible single occupant washroom general floor plan .....	10
Figure 4: Washroom accessory heights .....	12
Figure 5: Multi-stall washroom with accessible stall general floor plan .....	13
Figure 6: Accessible stall general floor plan .....	15
Figure 7: Barrier-free shower general floor plan .....	16
<b>Accessible lifts</b> .....	<b>17</b>
Figure 8: How to choose between an accessible lift and an elevator to best suit your access needs .....	17
Figure 9: How to choose the accessible lift that best suits your accessibility needs .....	18
Figure 10: Inclined platform lift .....	19
Figure 11: Vertical platform lift (with enclosure option) .....	20
<b>Elevators</b> .....	<b>21</b>
Figure 12: How to choose the passenger elevator that best suits your accessibility needs .....	21
Figure 13: Limited use, limited application elevator .....	22
Figure 14: Hydraulic elevator .....	23
Figure 15: Traction elevator .....	25
<b>Pool lifts</b> .....	<b>27</b>
Figure 16: How to choose the pool lift that best suits your accessibility needs .....	27
Figure 17: Above-ground pool chair lift .....	28
Figure 18: Permanent in-ground pool lift .....	29
<b>Multi-sensory environments</b> .....	<b>30</b>
Figure 19: How to choose the multi-sensory space that best suits your accessibility needs .....	30
Figure 20: Multi-sensory room .....	31
Figure 21: Multi-sensory mobile station .....	34
<b>Accessible playgrounds</b> .....	<b>36</b>
Figure 22: How to choose the accessible playground that best suits your accessibility needs .....	37
Figure 23: Accessible playground - small .....	38
Figure 24: Accessible playground – medium .....	40
Figure 25: Accessible playground – large .....	41



<b>Accessible parking .....</b>	<b>42</b>
Figure 26: Accessible parking – single – below grade.....	43
Figure 27: Accessible parking – multiple – below grade.....	44
Figure 28: Accessible parking – below grade vs at grade.....	46
<b>Accessible drop-off areas .....</b>	<b>47</b>
Figure 29: Accessible drop-off area .....	48
<b>Accessible electric vehicle charging stations.....</b>	<b>50</b>
Figure 31: Accessible EV charging station – multiple – at grade.....	51
Figure 32: Accessible EV charging station – single – below grade.....	52
Figure 33: Accessible EV charging station – multiple – below grade.....	53



## List of figures

- **Figure 1:** Ramps
- **Figure 2:** Accessible doors
- **Figure 3:** Accessible single occupant washroom general floor plan
- **Figure 4:** Washroom accessory heights
- **Figure 5:** Multi-stall washroom with accessible stall general floor plan
- **Figure 6:** Accessible stall general floor plan
- **Figure 7:** Barrier-free shower general floor plan
- **Figure 8:** How to choose between an accessible lift and an elevator to suit your accessibility needs
- **Figure 9:** How to choose the accessible lift that best suits your accessibility needs
- **Figure 10:** Inclined platform lift
- **Figure 11:** Vertical platform lift (with enclosure)
- **Figure 12:** How to choose the passenger elevator that best suits your accessibility needs
- **Figure 13:** Limited application, limited use elevator
- **Figure 14:** Hydraulic elevator
- **Figure 15:** Traction elevator
- **Figure 16:** How to choose the pool lift that best suits your accessibility needs
- **Figure 17:** Above-ground pool chair lift
- **Figure 18:** Permanent in-ground pool lift
- **Figure 19:** How to choose the multi-sensory space that best suits your accessibility needs
- **Figure 20:** Multi-sensory environment room
- **Figure 21:** Multi-sensory mobile station
- **Figure 22:** How to choose the accessible playground that best suits your accessibility needs
- **Figure 23:** Accessible playground – small
- **Figure 24:** Accessible playground – medium
- **Figure 25:** Accessible playground – large
- **Figure 26:** Accessible Parking – single – below grade
- **Figure 27:** Accessible parking – multiple – below grade
- **Figure 28:** Accessible parking – below grade vs at grade
- **Figure 29:** Accessible drop-off area
- **Figure 30:** Accessible EV charging station – single – at grade
- **Figure 31:** Accessible EV charging station – multiple – at grade
- **Figure 32:** Accessible EV charging station – single – below grade
- **Figure 33:** Accessible EV charging station – multiple – below grade



## Flat rate description for construction projects

When applying to the Enabling Accessibility Fund, an interactive calculator guides you through a series of options. This will help you determine the amount of eligible funding for:

- ramps
- accessible doors
- accessible washrooms
- accessible lifts
- elevators
- pool lifts
- multi-sensory environments
- accessible playgrounds
- accessible parking
- accessible drop-off areas
- accessible electric vehicle charging station

## How do flat rate costs work

The flat rate costs take many factors into consideration, such as:

- the essential items and components needed to meet accessibility standards
- the fair market value for materials and labour
- the construction materials that are standard commercial grade
- project location
- necessary permits and professional fees

The flat rate costs also consider:

- accessibility and safety features or accessories you may wish to add to your project
- the scope of the construction activities.
  - For example, costs for upgrades to an existing washroom or for an addition to a building to accommodate a new accessible washroom.

## How will project location impact funding amounts

Flat rate adjusts costs based on the project location. This analysis includes how remote the project location is or how difficult it is to access.



## Project planning and contingency

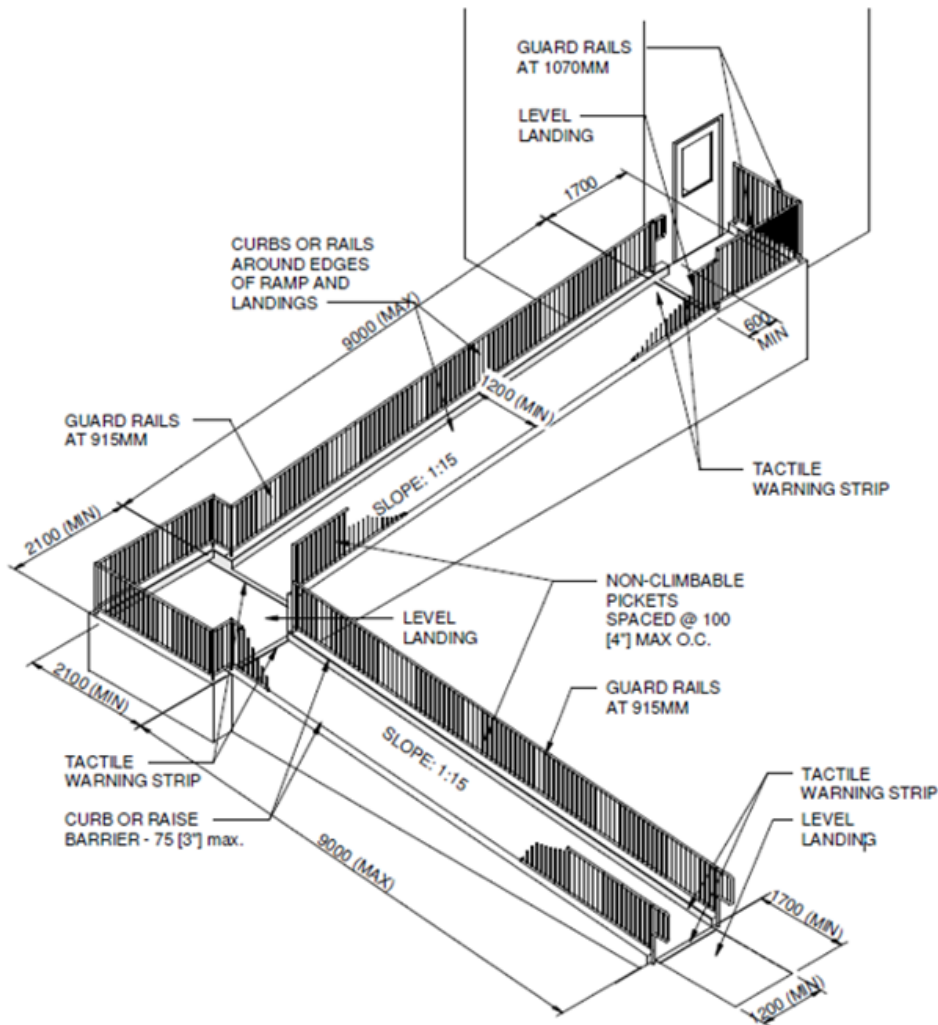
Flat rate will calculate eligible costs for each project. Yet, unexpected situations and costs are common with construction projects. We recommend that you consult certified professionals to scope your project. We also recommend that you have a contingency budget of approximately 20% of your total project costs to offset unexpected costs.

**Please note:** Supply chain issues and labour shortages have the potential to impact construction projects beyond normal industry standards. Additional due diligence confirming project timelines, scope and costs with certified professionals is recommended when planning your accessibility project.



# Ramps

Figure 1: Ramps



Source: Figure 34(a), CSA/ASC B651:23 Accessible design for the built environment. © 2023 Canadian Standards Association

A ramp is a slope or incline joining 2 different levels, at the entrance or between floors of a building. Ramps allow wheelchairs and other mobility aids to more easily access a building or navigate between areas of different heights. Along the ramp, there are safety features such as curbs, guard rails, handrails, pickets, and tactile warning strips.



These features help people go up and down the ramp safely. For example, tactile warning strips indicate the change in flooring at the entrance of the door and where the ramp curves:

- the grade of the ramp is no more than 1:15
- the width is a minimum of 3'9" (1200 mm) wide
- guard rails are 3' (915 mm) high
- pickets are no more than 4" (100 mm) apart

---

**Ramps include:**

- ramp and landings
- curbs, guard rails, handrails and pickets
- structural framing
- tactile warning/colour contrasting strips
- supportive foundation

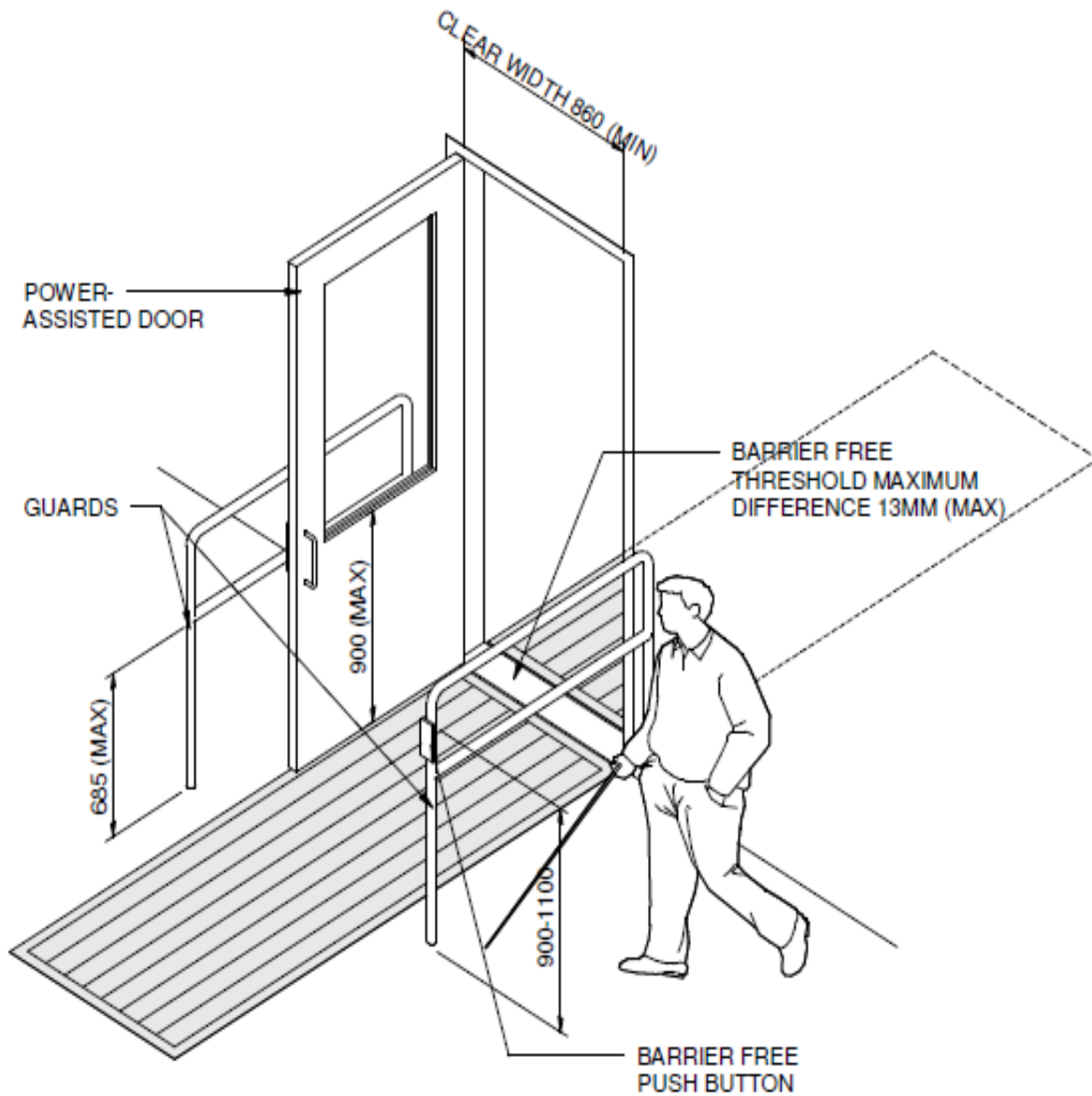
---

**Optional accessibility feature:**

- weather cover for exterior ramp

# Accessible doors

Figure 2: Accessible doors



Source: Figure 23, CSA/ASC B651:23 Accessible design for the built environment. © 2023 Canadian Standards Association



Accessible doors have windows low enough for persons in assistive devices, such as wheelchairs and scooters, to be seen from the other side. They have an automatic door operator with push button or sensor controls powered by electricity. The controls are located either on a guard rail or wall. Guards or guard rails are on either side of the door, and are an optional accessibility and safety feature for persons with visual or mobility impairments. Painting the door and door frame in contrasting colours helps with depth perception for those with visual impairments.

---

**Exterior doors include:**

- insulated door with insulated glass window
  - insulated steel frame
  - door hardware set
  - automatic door operator and controls
  - electrical power connection
  - colour contrasting painting and finishing
- 

**Interior doors include:**

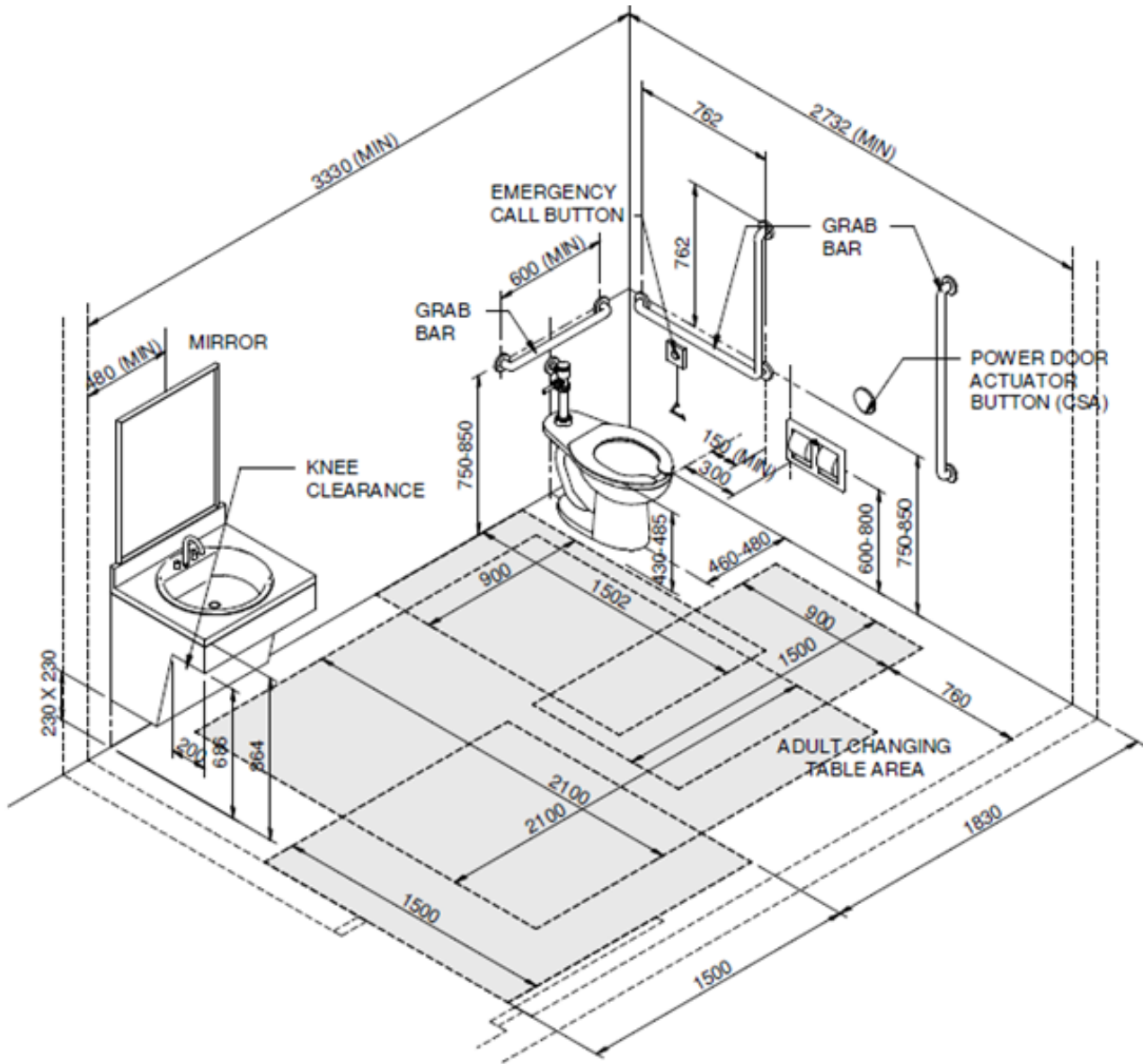
- non-insulated hollow metal door with non-insulated glass window
  - non-insulated pressed steel frame
  - door hardware set
  - automatic door operator and controls
  - electrical power connection
  - colour contrasting painting and finishing
- 

**Optional accessibility feature:**

- cane detectable guardrails

# Accessible washrooms

Figure 3: Accessible single occupant washroom general floor plan



Source: Figure 49(a), CSA/ASC B651:23 Accessible design for the built environment. © 2023 Canadian Standards Association



The size of an accessible washroom is approximately 9' by 10'11" (2732 mm by 3330 mm). The sink or vanity has space underneath for a person with an assistive device to fit their knees. Insulated pipes protect the knees from the hot water supply. Beside the sink, there is a clear area for a person to move from their assistive device onto the toilet, which has a backrest and is surrounded by grab bars for support. Walls painted in a different colour than the door frames, floor, adjacent wall, or plumbing fixtures helps with depth perception for those with visual impairments.

---

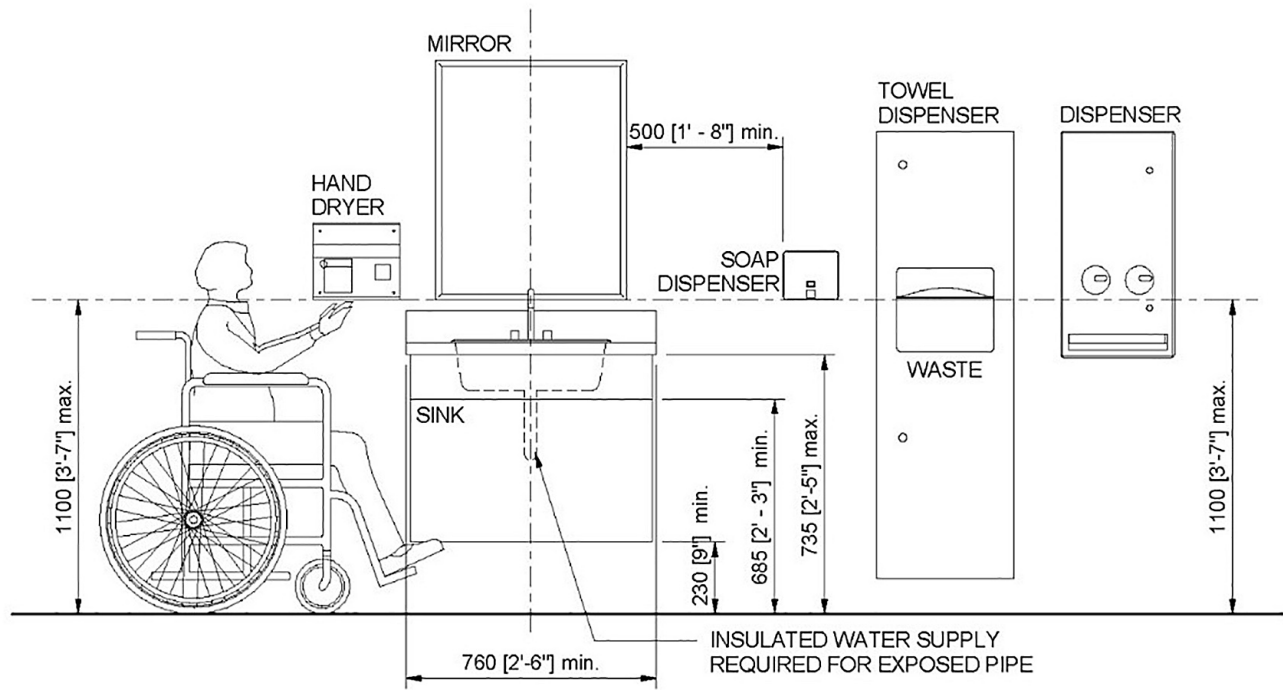
**Accessible washrooms include:**

- barrier-free toilet
  - barrier-free sink and vanity with knee protection
  - 2 grab bars
  - accessible angled mirror
  - non-slip flooring
  - washroom accessories
    - soap dispenser
    - toilet paper dispenser
    - paper towel dispenser or hand dryer
    - napkin disposal
  - colour contrasting painting
  - directional braille signage (a system where dots represent letters and words)
  - interior finishes such as minor repairs to floors, walls, and ceilings
- 

**Optional accessibility features:**

- accessible urinal
- emergency call button
- power assisted adult change table
- barrier-free shower

**Figure 4: Washroom accessory heights**



**Source:** Figure 44, CSA/ASC B651:23 Accessible design for the built environment. © 2023 Canadian Standards Association


All washroom accessories are approximately at eyesight level for wheelchair users. The sink's insulated water supply and drain pipes protect persons in wheelchairs from leg injuries.

**Accessories include:**

- a hand dryer
- a soap dispenser
- a towel dispenser
- waste bin
- a dispenser for various items (for example, feminine hygiene products)







A multi-stall washroom with an accessible stall has clear areas that separate the sinks and the stalls. This gives enough space for a person with an assistive device, such as a wheelchair, to move around.

---

**The barrier-free stall has:**

- a door that opens outward, which provides space for a person with an assistive device to enter the stall
  - a “D” type door pull on the inside and one on the outside
- 

**Accessible stalls include:**

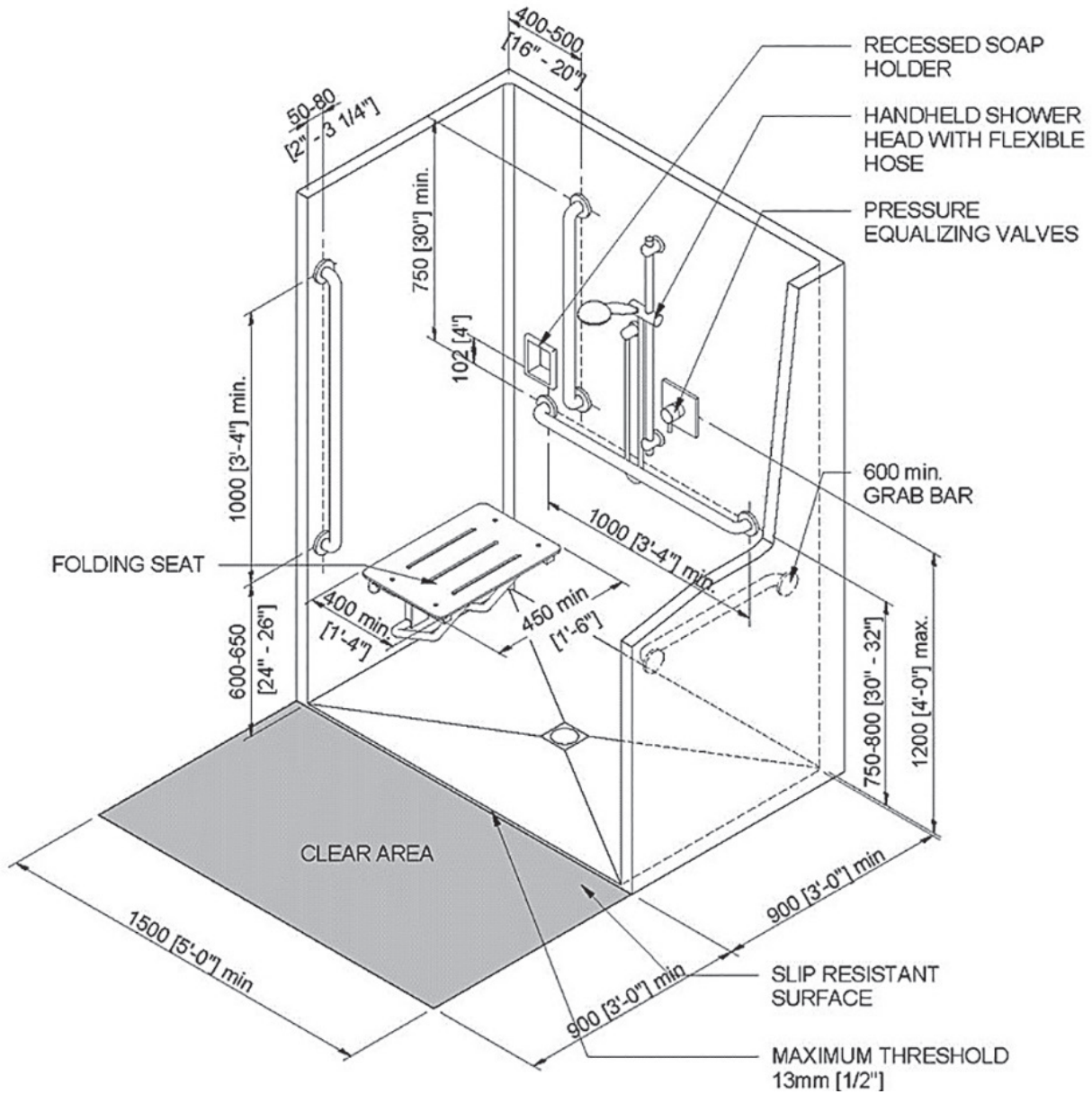
- barrier-free toilet
  - barrier-free sink and vanity with knee protection
  - 2 grab bars
  - accessible angled mirror
  - directional braille signage
  - colour contrasting painting to help with depth perception for those with visual impairments
  - washroom accessories
    - soap dispenser
    - toilet paper dispenser
    - paper towel dispenser or hand dryer
    - napkin disposal
  - metal washroom partitions and door
  - non-slip flooring
  - interior finishes such as minor repairs to floors, walls, and ceilings
- 

**Optional accessibility features:**

- accessible urinal
- emergency call button
- power assisted adult change table
- barrier-free shower



Figure 7: Barrier-free shower general floor plan



Source: Figure 51, CSA/ASC B651:23 Accessible design for the built environment. © 2023 Canadian Standards Association

**Accessible showers include:**

- shower kit
  - handheld shower head and accessible controls
- recessed soap holder
- folding seat
- 4 grab bars
- non-slip flooring

# Accessible lifts

Figure 8: How to choose between an accessible lift and an elevator to best suit your access needs

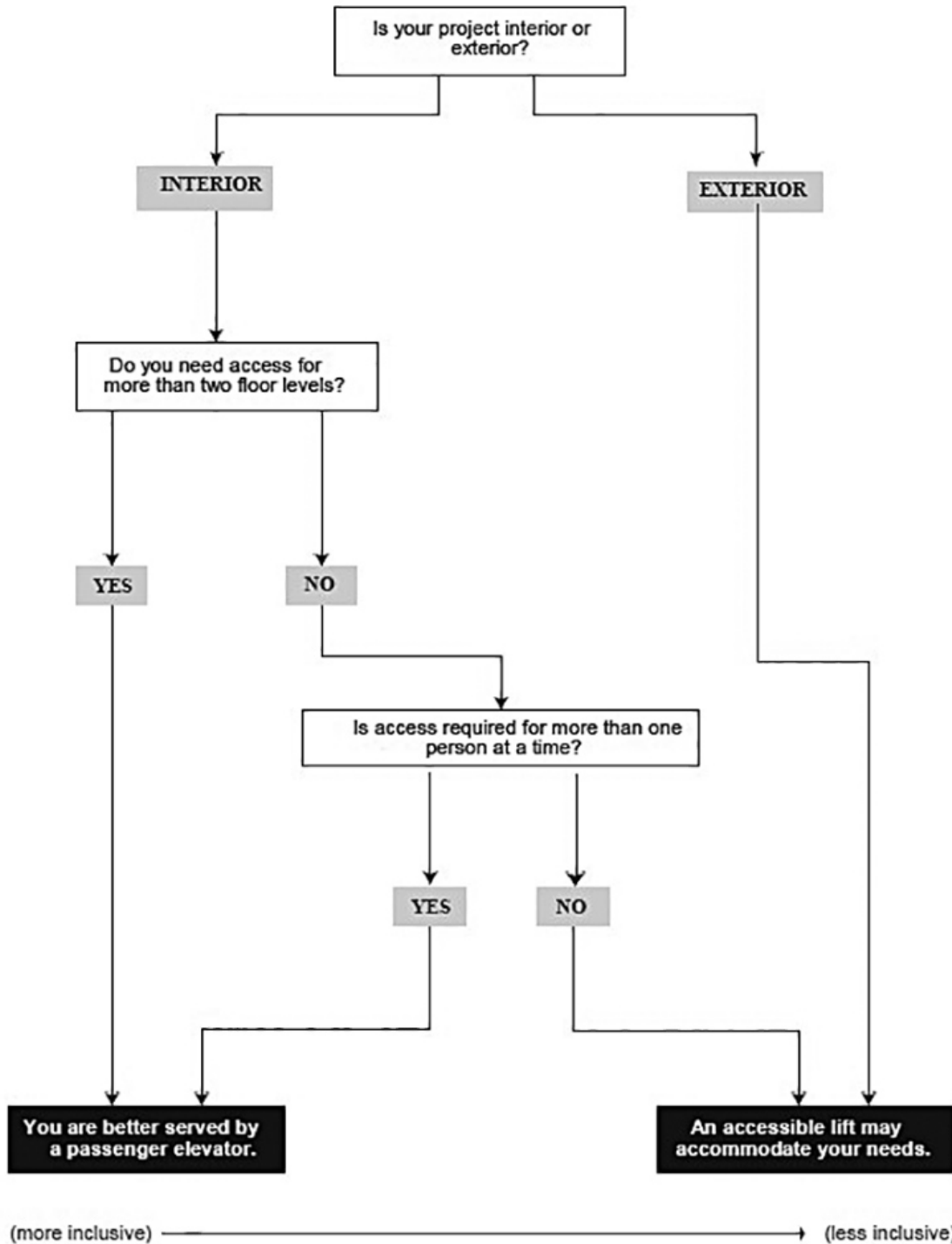
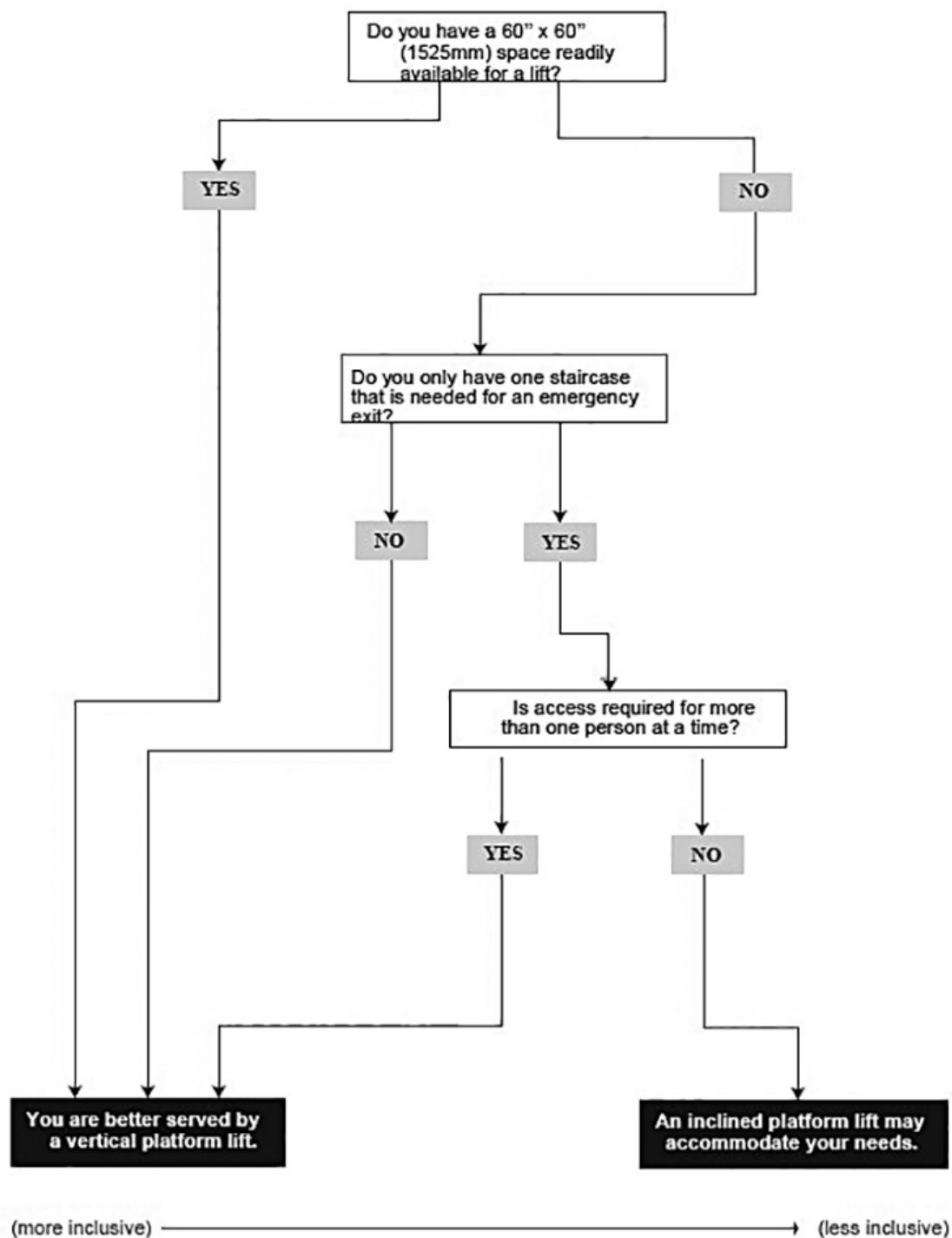


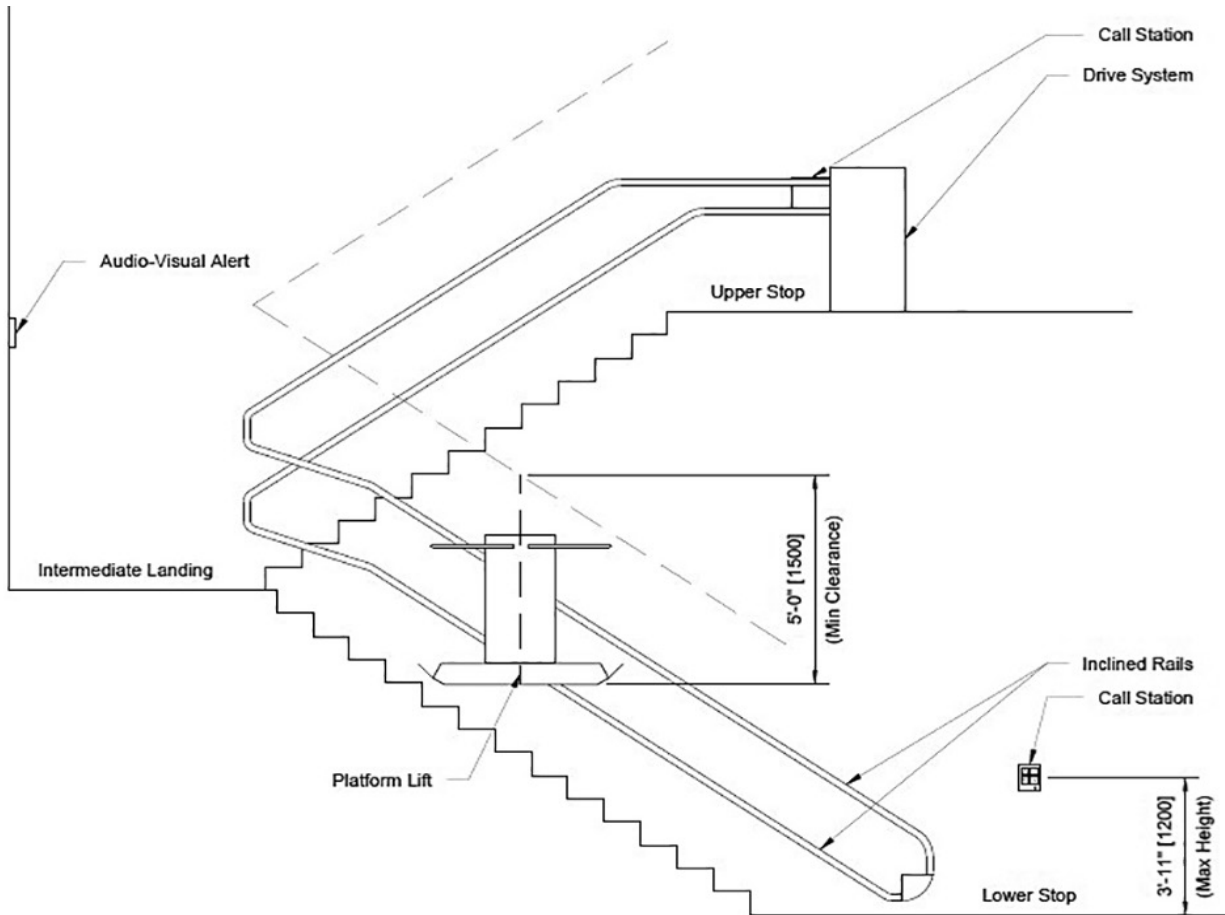


Figure 9: How to choose the accessible lift that best suits your accessibility needs





**Figure 10: Inclined platform lift**



Source: NBC 2015 / CSA/ASC B651:23 / CSA B355:19

A platform lift is attached by inclined rails to sets of stairs. At the bottom of the stairs is a call station button for assistance when needed. At the top of the landing is an audio visual alert to let people know the lift is in use. At the top of the second flight of stairs is another call button as well as the drive system machinery.

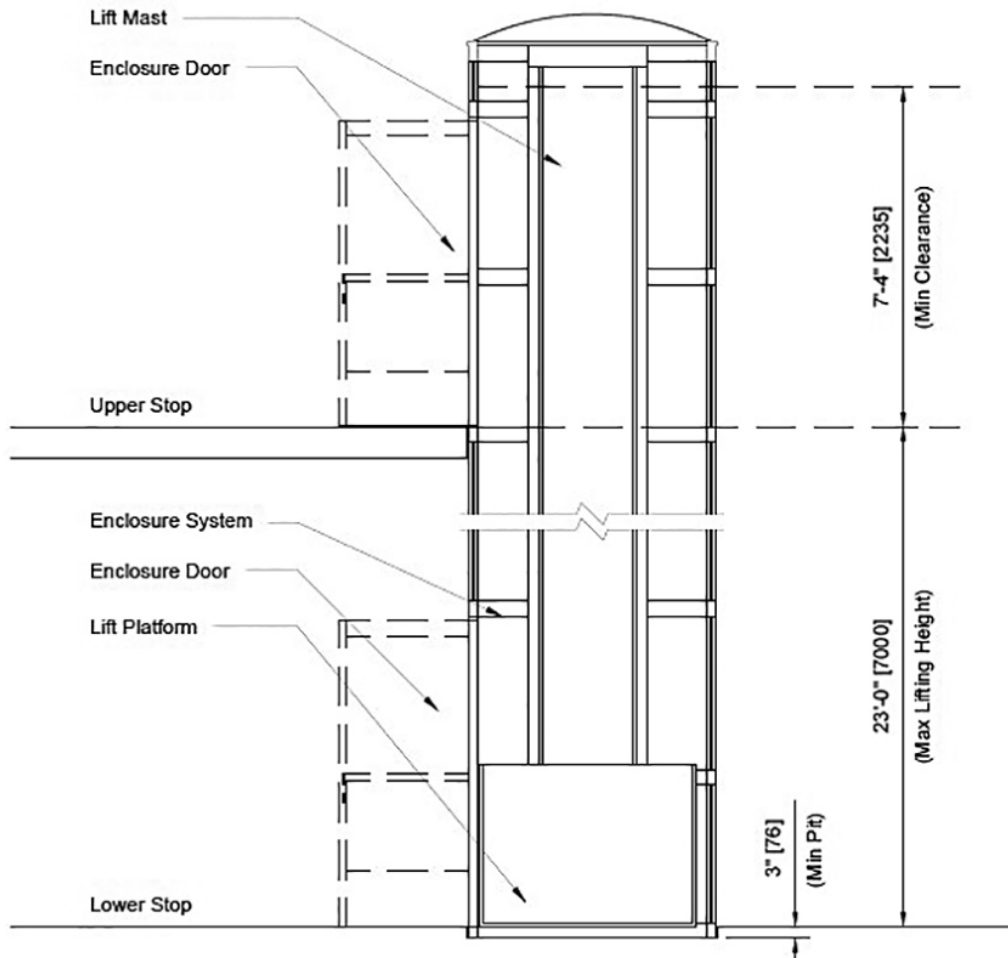
**Interior and exterior platform lifts include:**

- platform lift unit
- controls
- inclined rails
- electrical power connection

**Optional accessibility features:**

- fire alarm integration
- lighting
- fold-down seat with seatbelt
- directional braille signage

**Figure 11: Vertical platform lift (with enclosure option)**



Source: NBC 2015 / CSA/ASC B651:23 / CSA B355:19

**Vertical platform lifts include:**

- platform lift unit
- controls
- electrical power connection
- pit
- lift mast

**For lifts that are over 8' (2.5 m) or exposed to rain and snow, an enclosure will be automatically calculated in the flat rate cost.**

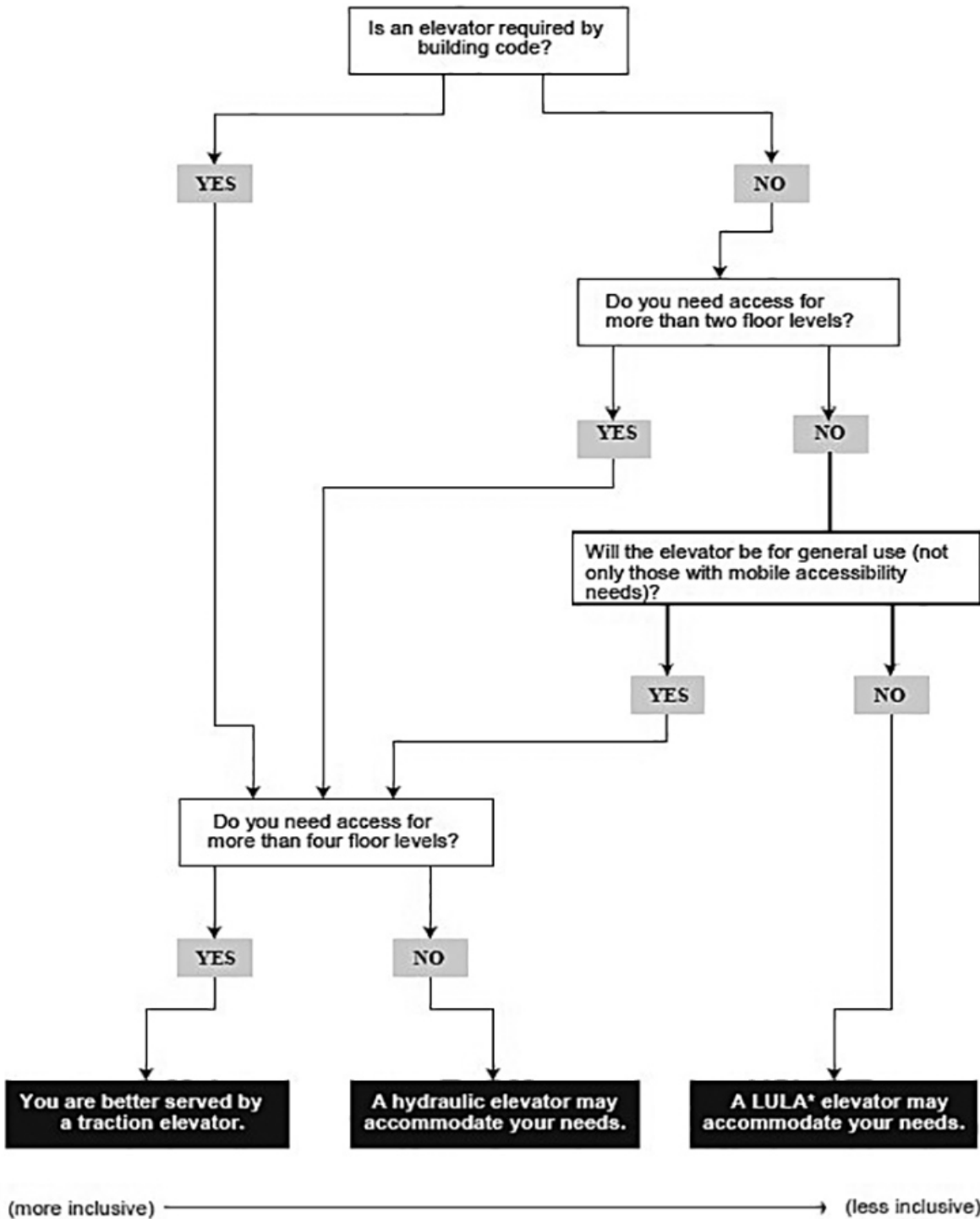
**Optional accessibility features:**

- fire alarm integration
- lighting
- directional braille signage

# Elevators

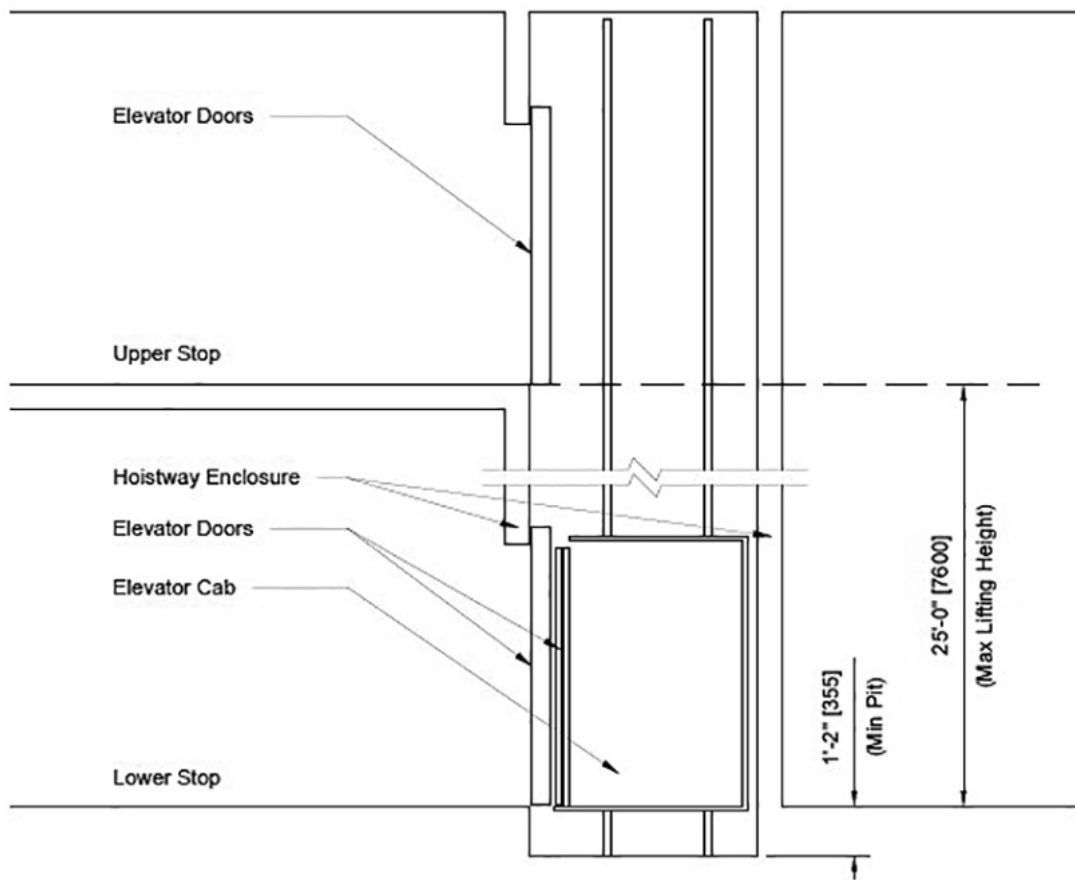
A panel of elevator controls should be located at eyesight level for better accessibility for persons with assistive devices, such as a wheelchair.

Figure 12: How to choose the passenger elevator that best suits your accessibility needs





**Figure 13: Limited use, limited application elevator**



Source: NBC 2015 / CSA/ASC B651:23 / CSA B44:16

LULA elevators provide direct vertical access between two or more levels. The elevator cab can accommodate a limited number of occupants. These elevators require smaller pits and machine rooms, and are suitable for confined spaces.

**Limited use, limited application elevators include:**

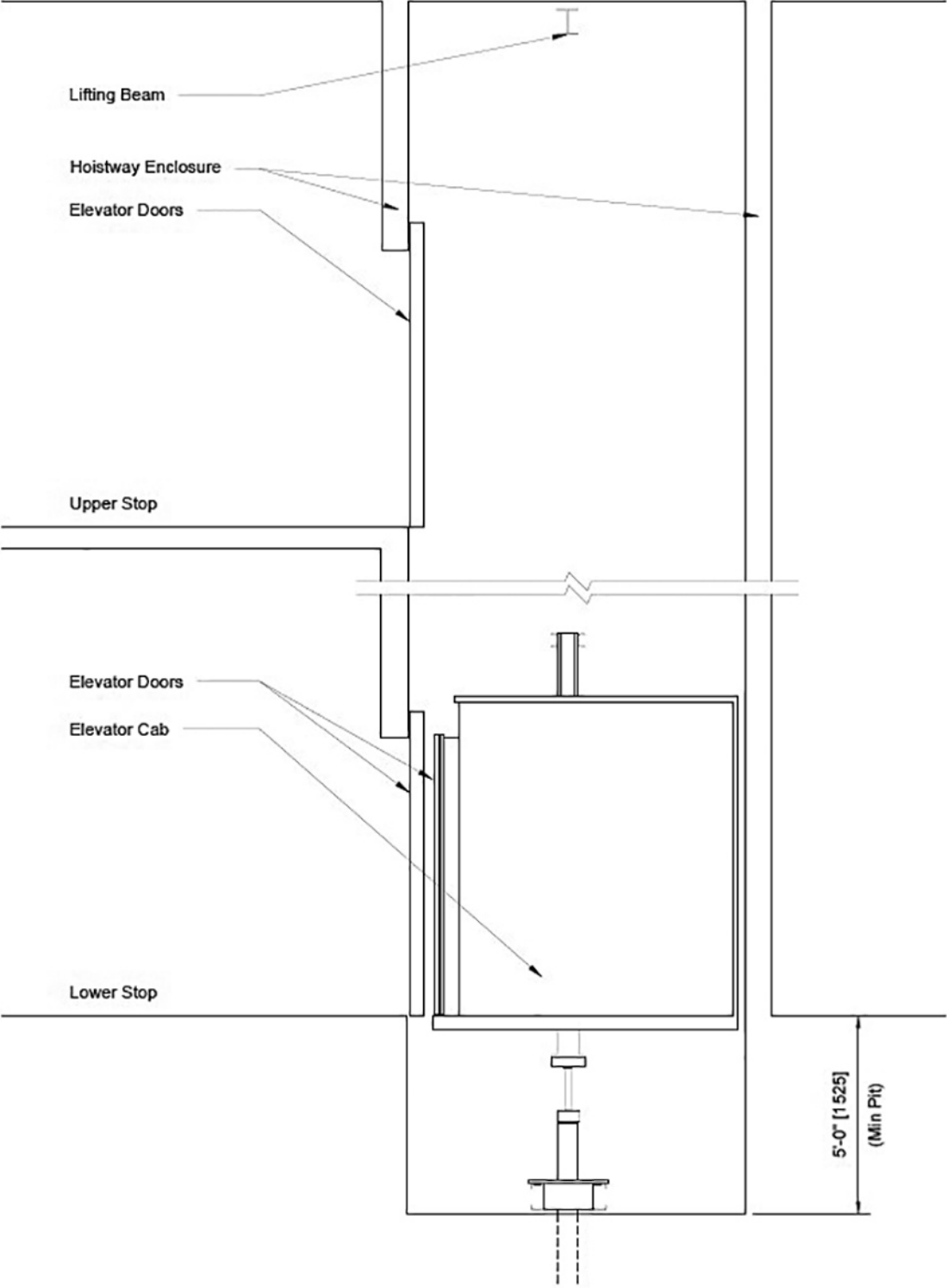
- doors
- controls
- hydraulic cylinder, motor and tank rails
- electrical power connection
- pit
- machine room
- hoist way (the enclosure of an elevator or shaft)
- elevator cab where the passengers ride

**Optional accessibility feature:**

- directional braille signage



Figure 14: Hydraulic elevator



Source: NBC 2015 / CSA/ASC B651:23 / CSA B44:16



Hydraulic elevators provide direct vertical access between two or more levels. The elevator cab can be sized to accommodate a range of occupants. These elevators are suitable for low to mid-rise applications (up to approximately five stops).

---

**Hydraulic elevators include:**

- doors
- controls
- hydraulic cylinder, motor and tank
- guide rails
- hoist way (the enclosure of an elevator or shaft)
- electrical service
- pit, fixed ladder, drain and sump
- machine room
- elevator cab with handrail and emergency telephone

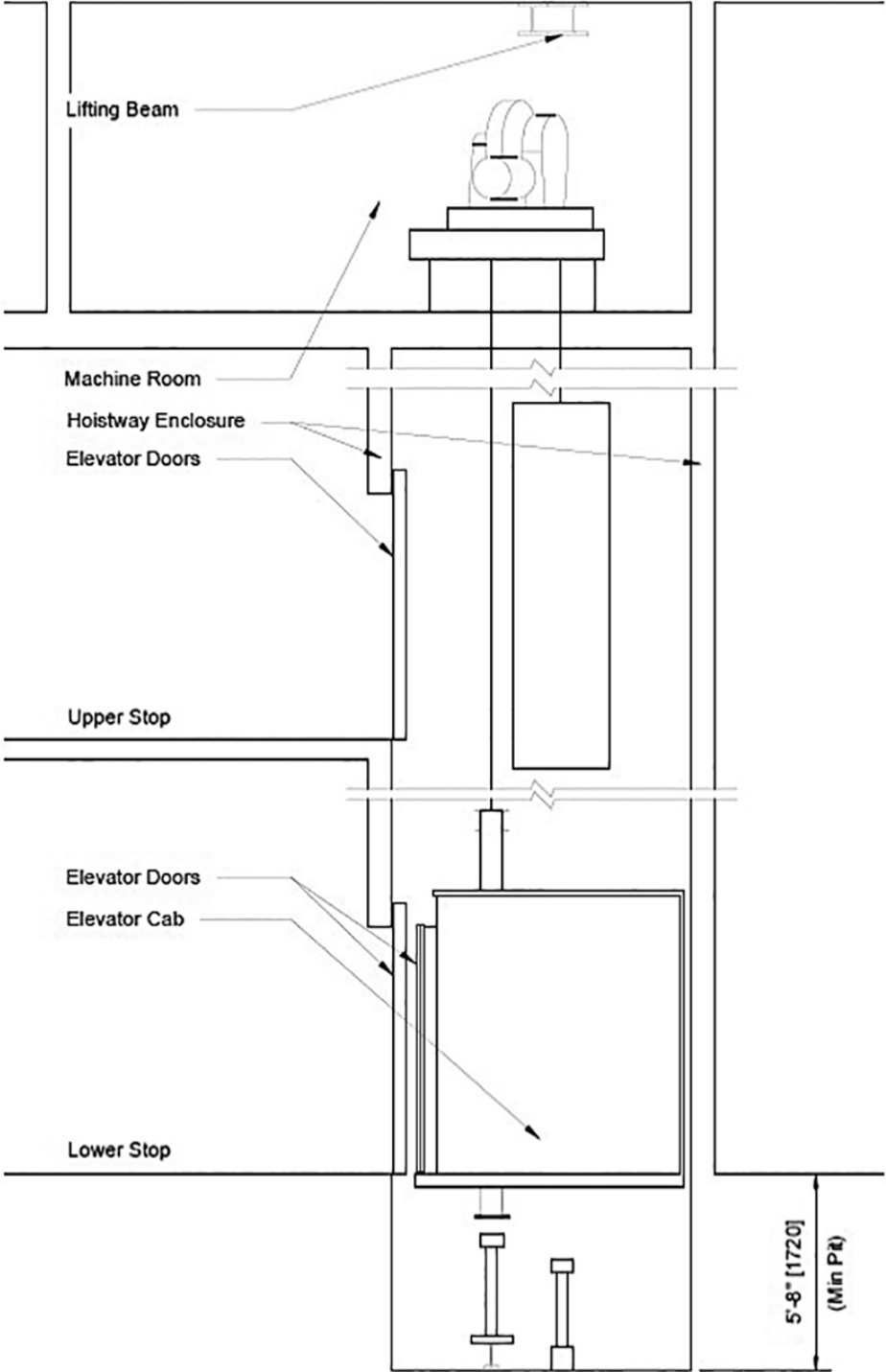
---

**Optional accessibility features:**


- directional braille signage
- hearing loop
- fold-down seat



Figure 15: Traction elevator



Source: NBC 2015 / CSA/ASC B651:23 / CSA B44:16



Traction elevators provide direct vertical access between two or more levels. The elevator cab can be sized to accommodate a range of occupants. These elevators are suitable for mid to high-rise applications (approximately five or more stops).

---

**Traction elevators include:**

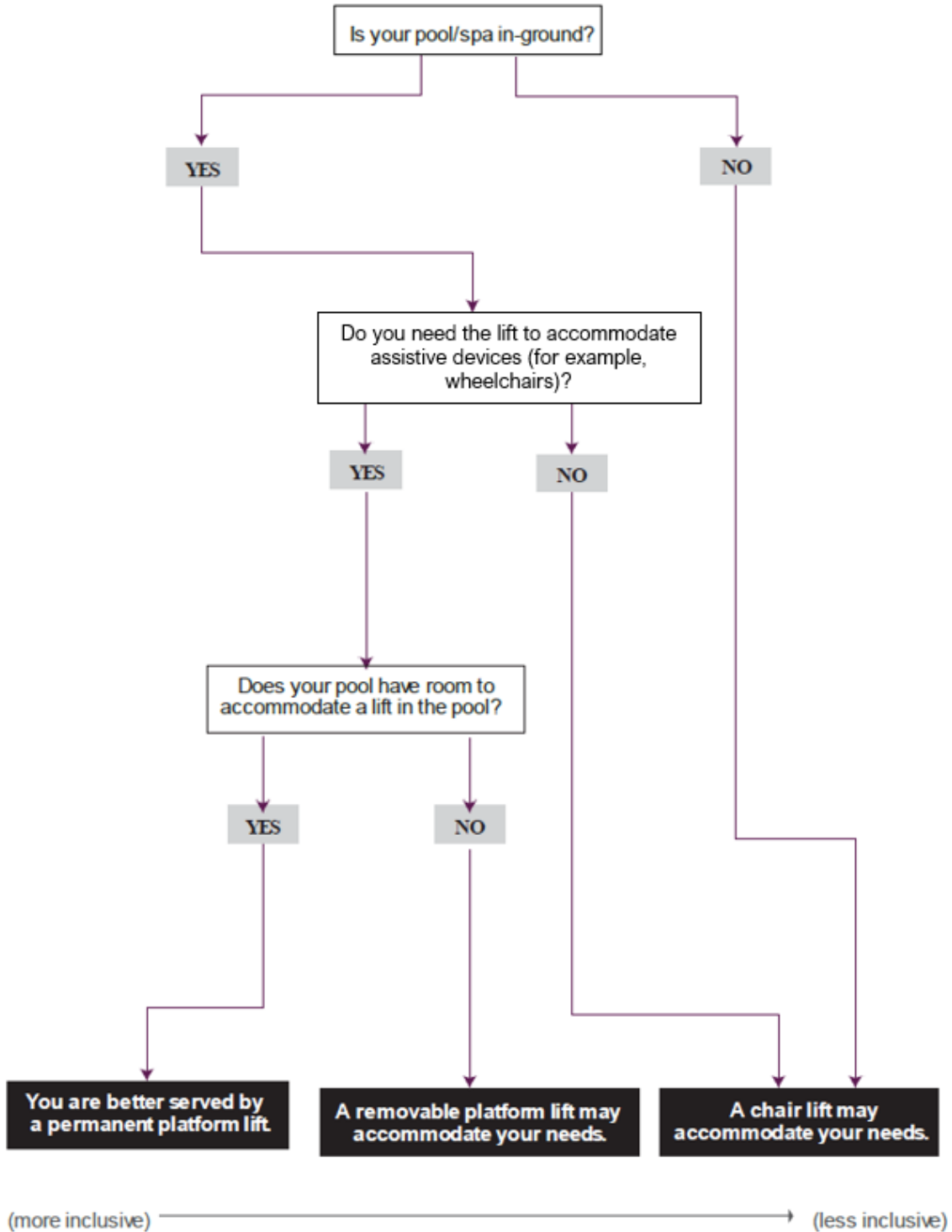
- elevator cab with handrail and emergency telephone
  - doors
  - controls
  - motor, counterweight
  - guide rails
  - suspension ropes
  - travelling cable
  - hoist way (the enclosure of an elevator or shaft)
  - lifting beam
  - electrical service
  - pit
  - fixed ladder, drain and sump
  - machine room
- 

**Optional accessibility features:**

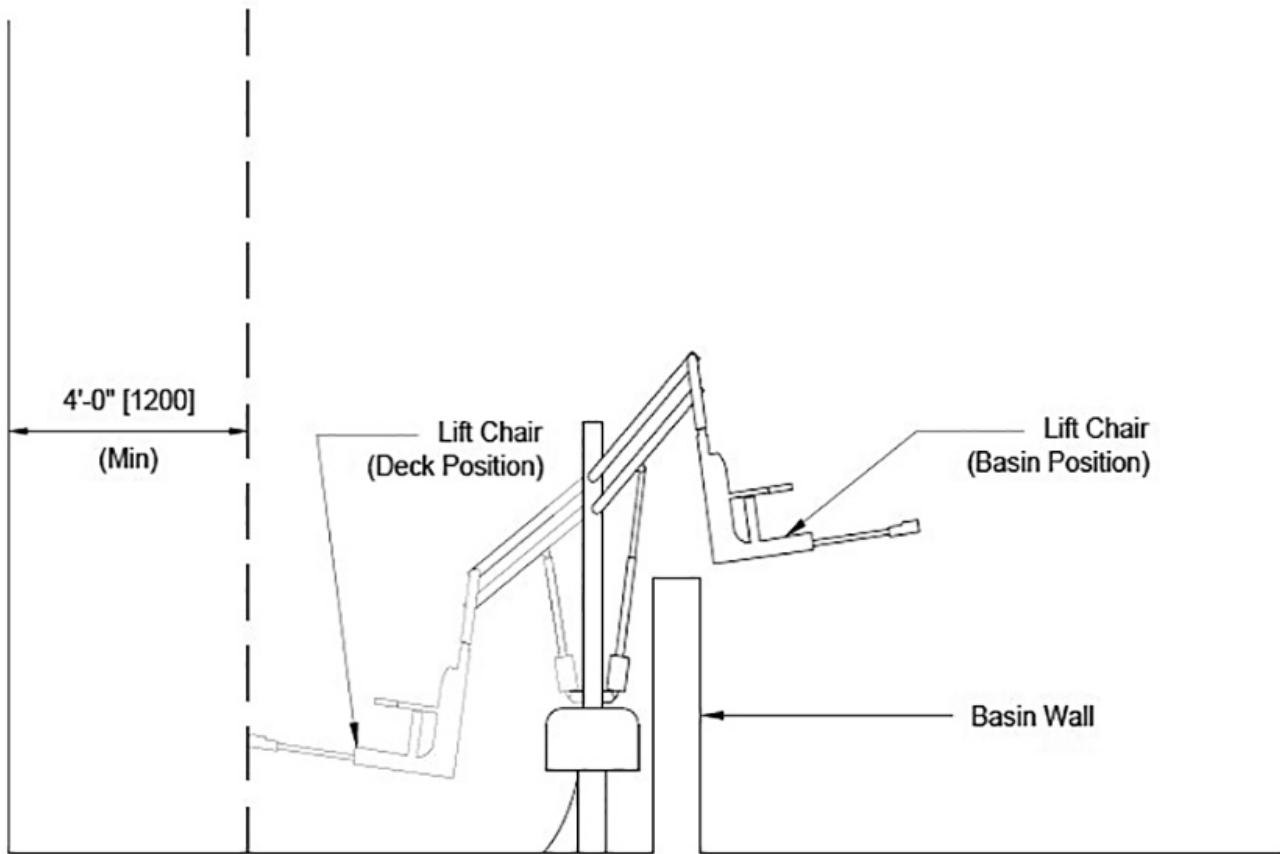
- directional braille signage
- hearing loop
- fold-down seat

# Pool lifts

Figure 16: How to choose the pool lift that best suits your accessibility needs



**Figure 17: Above-ground pool chair lift**



**Source:** NBC 2015 / CSA/ASC B651:23

A pool chair lift is a hard seat designed to carry a person in a seated position from the pool deck to the above-ground or in-ground pool. The chair swivels and lowers close to the basin wall to allow the person to exit.

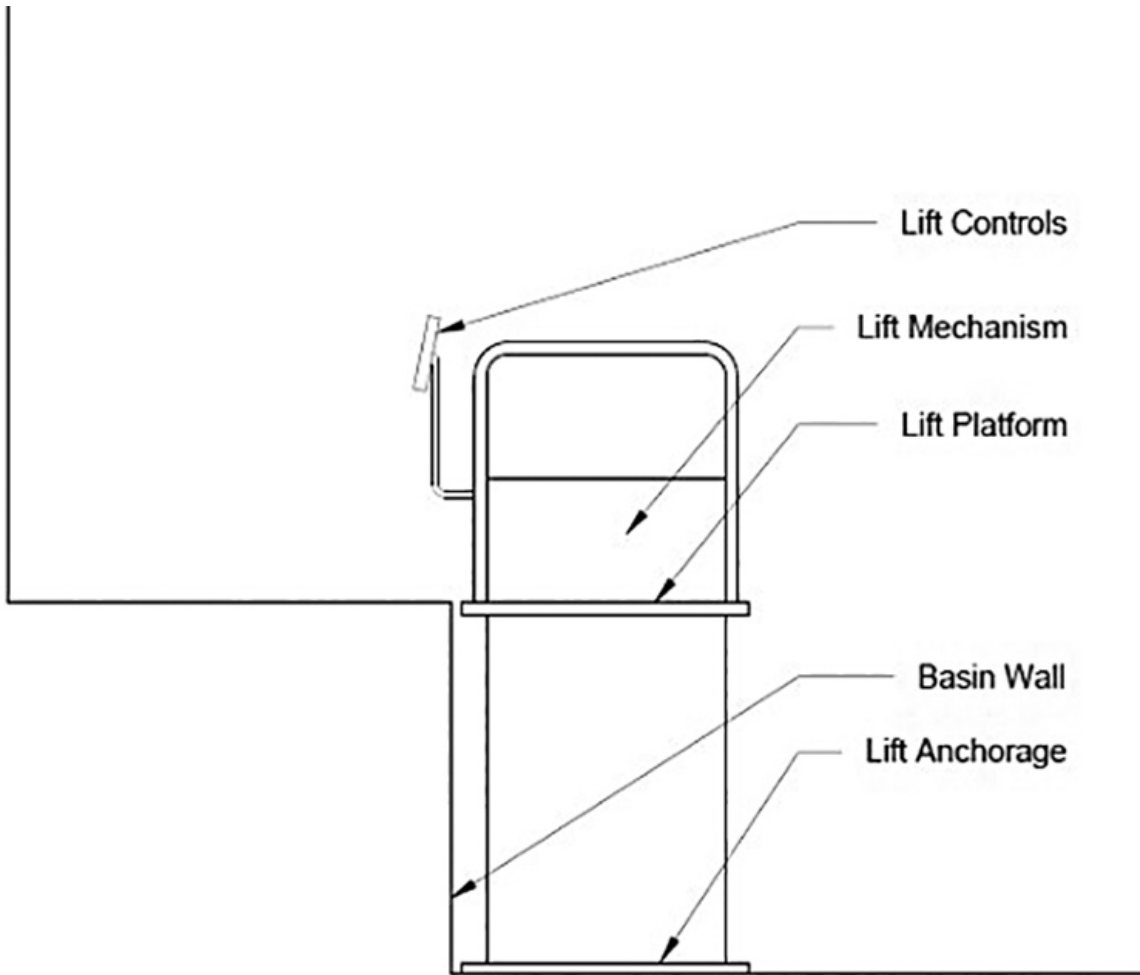
---

**Above-ground and in-ground pool chair lifts include:**

- chair lift unit
  - pool deck anchor
-



**Figure 18: Permanent in-ground pool lift**



Source: NBC 2015 / CSA/ASC B651:23

Platform pool lifts provide direct access between the pool deck and in-ground pool. The lift platform is designed to carry a person with a mobility device, so they can easily and autonomously get into the water. The lift controls can be operated by the occupant or attendee. The lift mechanism lowers the lift platform into the water along the edge of the basin wall.

---

**Permanent and portable platform pool lifts include:**

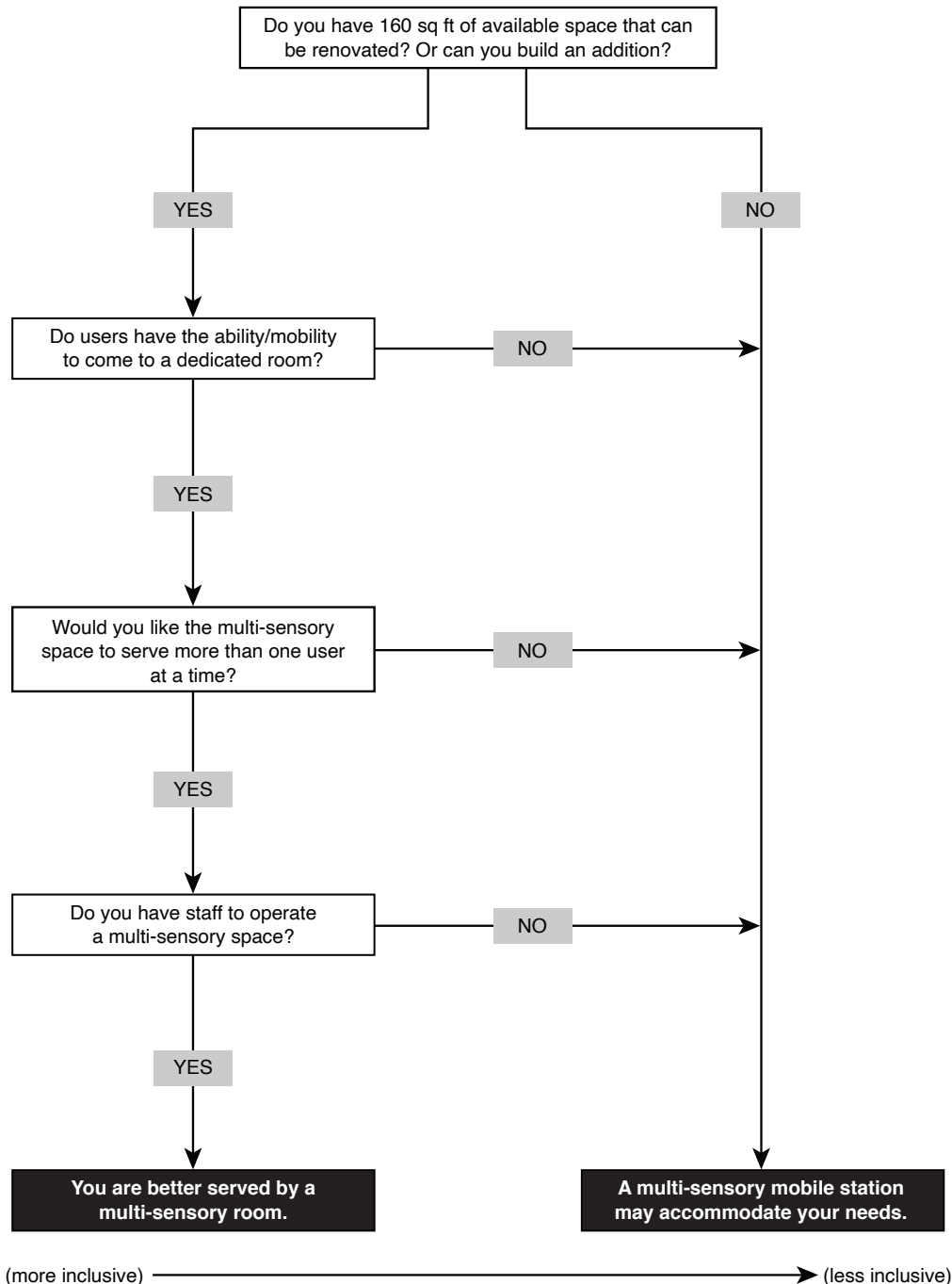
- platform lift unit
  - pool deck anchor
  - pool wheelchair
-



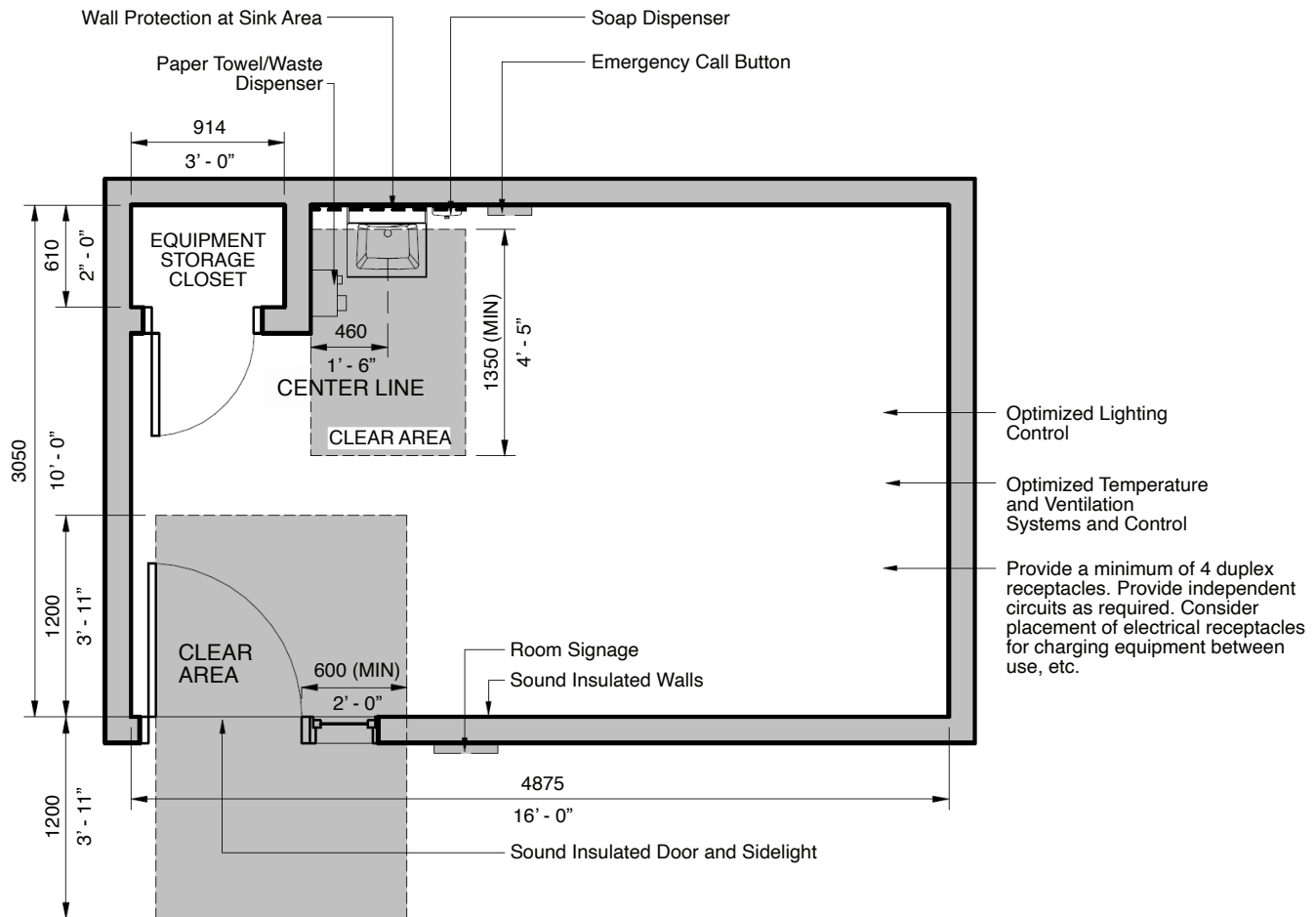
# Multi-sensory environments

Where possible, a multi-sensory room is the preferred environment to create a controlled space that is adaptable to the needs of a variety of participants.

**Figure 19: How to choose the multi-sensory space that best suits your accessibility needs**



**Figure 20: Multi-sensory room**



Multi-sensory rooms create a controlled, safe space devoted to stimulating or calming the senses. They can be relaxing spaces to help reduce agitation and anxiety. They can also engage the user to participate in activities, stimulate reactions, and encourage communication. Generally, the room is adaptable to a wide range of participant needs.

It is important to consult professionals, such as architects, mechanical and electrical engineers to optimize the soundproofing, and systems within the space. Professional fees are included in the flat rate cost.

A multi-sensory room includes finishing for approximately a 160 sq ft (15 m sq) or 10' by 16' room that includes a clear area to enter and exit the room. There is also a clear area to give access to the hand wash area. The sink has enough space underneath for persons in assistive devices to fit their knees, as well as protection from the hot water supply.



---

**Multi-sensory rooms include:**

- sound insulated walls
  - sound insulated door
    - insulated steel frame
    - door hardware set
    - automatic operator with controls
    - electrical power connection
    - barrier free transition
    - colour contrasting painting
  - optimized HVAC (beyond code minimums)
    - improved air quality
    - acoustic absorption
    - in room controls
  - optimized lighting
    - anti-glare lighting with dimmer
    - in room controls
  - optimized electrical
    - increased capacity for receptacles and circuits
    - minimum of 4 duplex receptacles in room
  - wall mounted hand wash sink
    - installed with modifications to existing plumbing
    - insulated piping or shroud
    - wall protection
    - soap dispenser
    - paper towel dispenser
    - waste bin
  - storage closet for sensory equipment
    - hollow metal door with steel frame
    - door hardware set
  - room signage with text, graphic and braille (a system where dots represent letters and words)
    - single plate outside room
    - 1 directional wayfinding sign placed elsewhere to direct users
-



## Sensory tools and equipment

The following packages give examples of items you could purchase with the amount of funding included with each package selected. These are examples only. You may purchase similar sensory items of an equivalent value that best suits your users. The packages you select will depend on the needs of the users of the multi-sensory room.

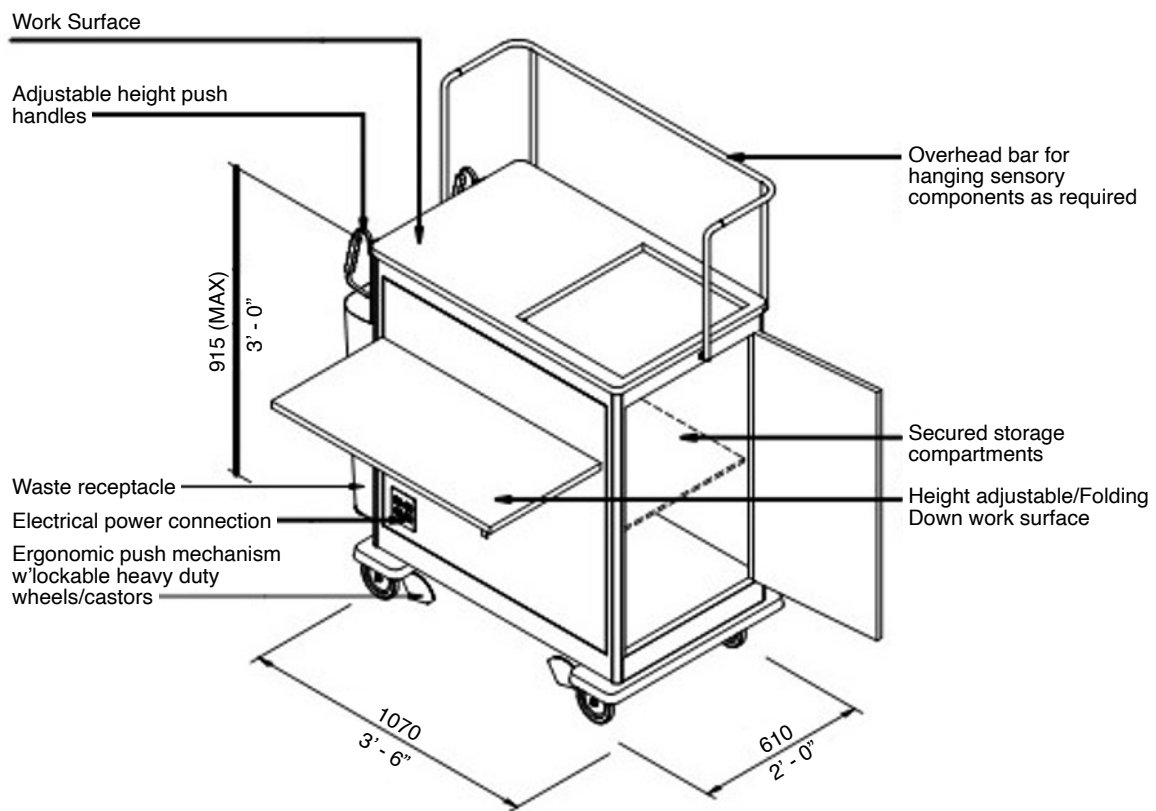
It is important to consult specialists, such as an occupational therapist, physical therapist, speech pathologist among others, when purchasing sensory equipment to customize the space and programming for the intended users.

- **Auditory package:** Items that produce music, tones, or other noises.
  - 5 toy musical instruments, 4 games, 1 sound machine
- **Visual package:** Items that produce light or other visual input.
  - 1 light table, 4 games, 2 lamps, 4 light panels, 1 projector package, 1 fibre optic light
- **Vibration or Vibroacoustic package:** Items designed to produce vibration. Vibroacoustic combines vibration and sound.
  - 1 vibroacoustic chair, 1 vibrating cushion, 1 vibrating pillow, 1 vibrating mat, 1 vibrating oral toy, 1 vibrating handheld toy
- **Muscle sense (Proprioception) package:** Items that activate joint and muscle involvement.
  - 1 mini trampoline, 1 bouncy chair, 3 body socks (small, medium, large), 1 squeeze machine, 1 weighted blanket with adjustable weights, 1 weighted vest with adjustable size, 1 weighted toy for lap or over shoulders
- **Movement (Vestibular) package:** Items designed to cause movement.
  - 1 swing, 1 spinner, 1 beam, 1 scooter, 1 wobble cushion, 1 therapy ball, 1 rocker seat, 1 balance board
- **Sensory Dampening package:** Items that allow user to reduce noise, visual input or other stimuli
  - 4 sets of noise cancelling headphones, 4 adjustable size eye masks

### Optional accessibility features:

- acoustic ceiling and acoustic non-slip flooring
- hygienic wall cladding
- specialized seating and work surfaces
  - a selection of chairs, mats, wedges
  - tables or decks that are height adjustable
- emergency call button
- additional sound insulated emergency exit door

**Figure 21: Multi-sensory mobile station**



A mobile station offers a multi-sensory environment where space or mobility of the users may be a consideration. The cart should be height adjustable to engage users while seated or standing.

**A multi-sensory cart includes:**

- height adjustable work surface
- height adjustable push handles
- heavy duty, locking wheels
- secure storage compartments
- overhead bar for hanging sensory components, as required
- electrical power connection with 4 outlets
- waste bin



## Sensory tools and equipment

The following packages give examples of items you could purchase with the funding included with each package selected. These are examples only. You may purchase similar sensory items of an equivalent value that best suits your users. The packages you select will depend on the needs of the users of the multi-sensory station.

It is important to consult specialists, such as an occupational therapist, physical therapist, speech pathologist, among others, when purchasing sensory equipment to customize the space and programming for the intended users.

- **Auditory package:** Items that produce music, tones or other noises.
  - 5 toy musical instruments, 3 games, 1 sound machine
- **Visual package:** Items that produce light or other visual input.
  - 4 games, 1 lamp, 1 tabletop light panel or box, 1 projector package, 1 fibre optic light
- **Vibration or Vibroacoustic package:** Items that produce vibration. Vibroacoustic combines vibration and sound.
  - 1 vibrating cushion, 1 vibrating pillow, 1 vibrating mat, 1 vibrating oral toy, 1 vibrating handheld toy
- **Muscle sense (Proprioception) package:** Items that activate joint and muscle involvement.
  - 3 body socks (small, medium, large), 1 weighted blanket with adjustable weights, 1 weighted vest with adjustable size, 1 weighted toy for lap or over shoulders
- **Movement (Vestibular) package:** Items designed to cause movement.
  - 1 wobble cushion, 1 rocker seat, 1 balance board
- **Sensory Dampening package:** Items that allow user to reduce noise, visual input or other stimuli
  - 2 sets of noise cancelling headphones, 2 adjustable size eye masks

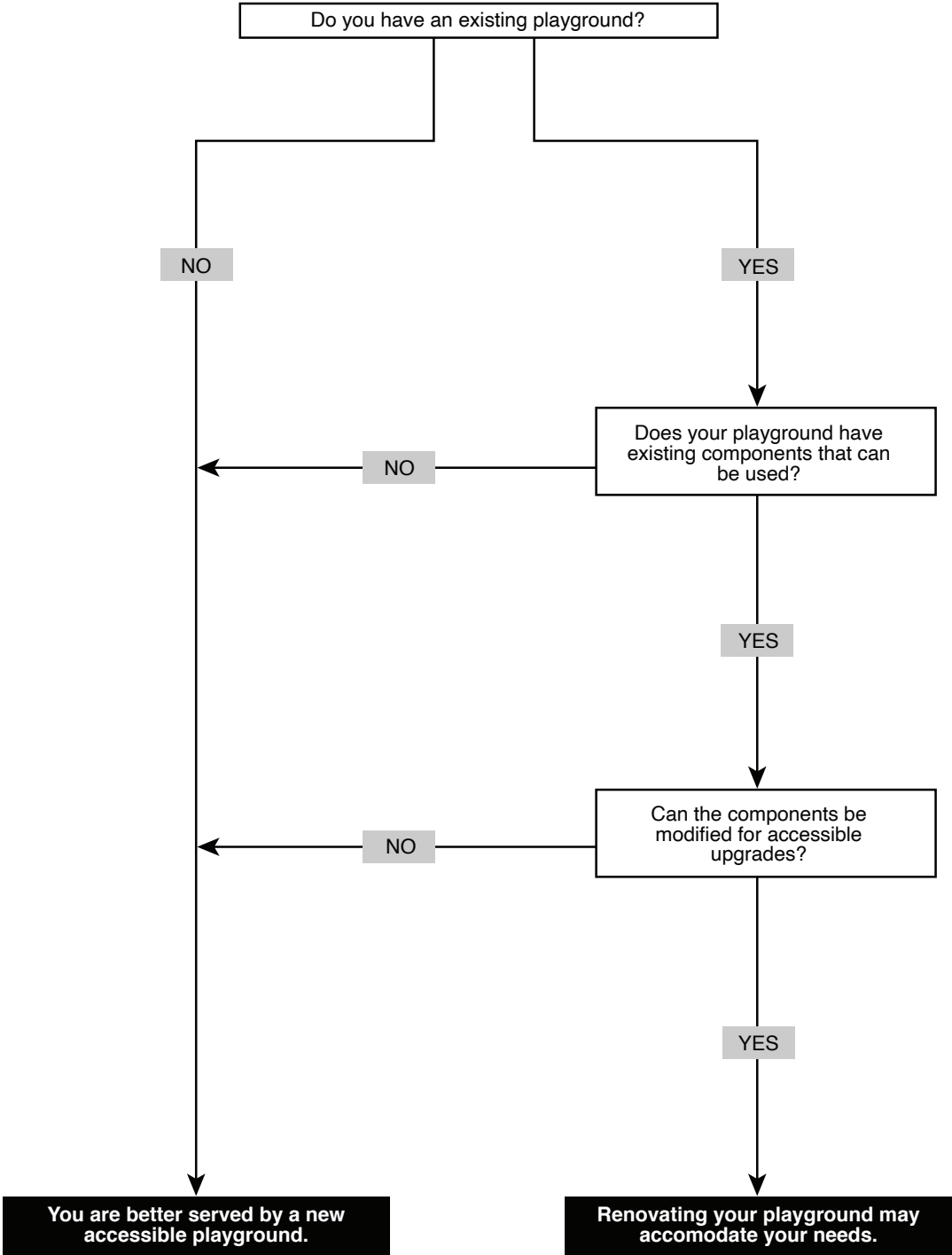


## **Accessible playgrounds**

Accessible playgrounds promote engagement and participation for all ages and abilities. They should provide a variety of play components. These components should give opportunities to challenge user's abilities and play types, such as social, physical, and mental experiences. A number of ground-level play components should be included for persons who cannot access elevated areas. It is important to consult with a landscape architect or playground designer when designing, building, or renovating your accessible playground.



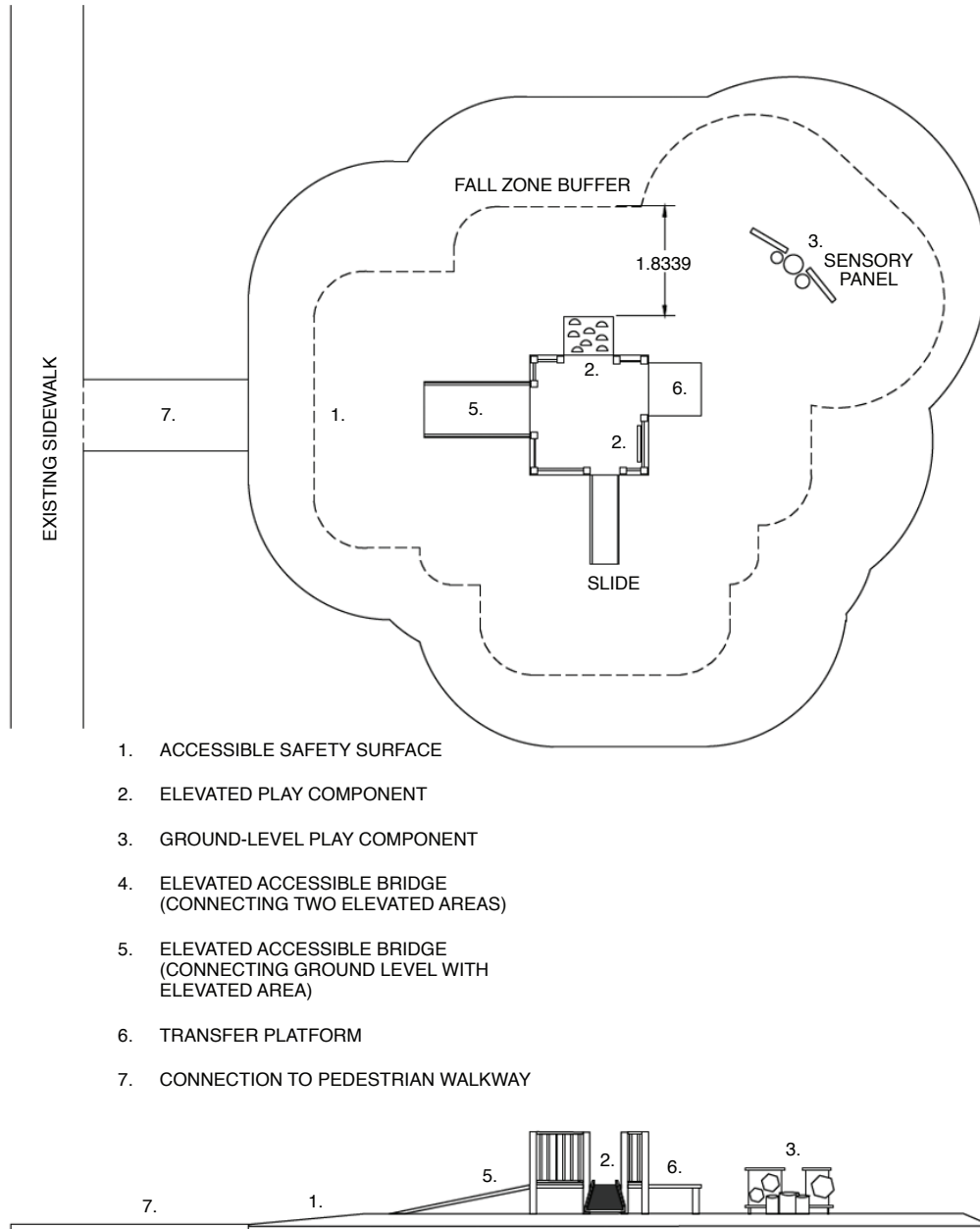
**Figure 22: How to choose the accessible playground that best suits your accessibility needs**



Note that if you are renovating a playground and removing all the existing playground equipment to build a new playground, the costs of removing the existing equipment will be automatically calculated in the flat rate cost.



**Figure 23: Accessible playground - small**





A path connects to an existing pedestrian walkway or sidewalk. It must be at least 150 mm wide and have a slope of no more than 5%. The accessible safety surface needs to be a certain depth based on fall heights and for drainage. The surfacing has a minimum border or “fall zone buffer” area that outlines the playground. Accessible bridges connect elevated areas to ground-level components. A transfer platform allows persons to transfer from their assistive mobility devices to elevated play components. A tactile orientation map allows users with visual impairments to navigate the play area.

---

**Accessible playgrounds include:**

- accessible safety surfacing
  - engineered wood fibre
  - pour-in place rubber (most accessible option for assistive devices, such as wheelchairs)
- elevated play components and/or ground-level play components such as,
  - elevated
    - climbers
    - slides
    - sensory play panels
  - ground
    - swings
    - spring riders
    - bouncers
    - sensory play panels
- elevated bridge and/or transfer platform to give access from the ground level to elevated play components
- path connection to pedestrian walkway

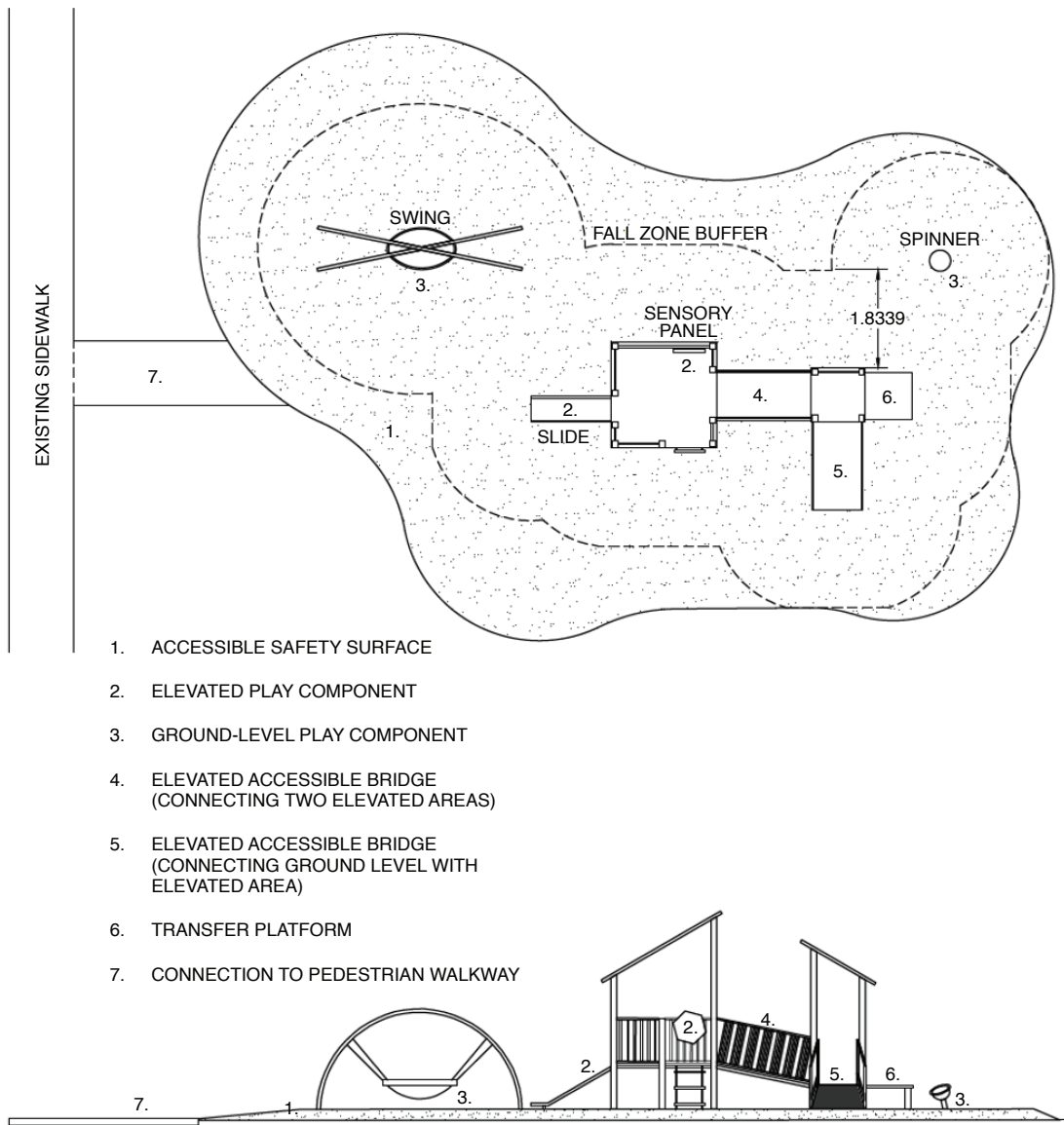
---

**Optional accessibility features:**

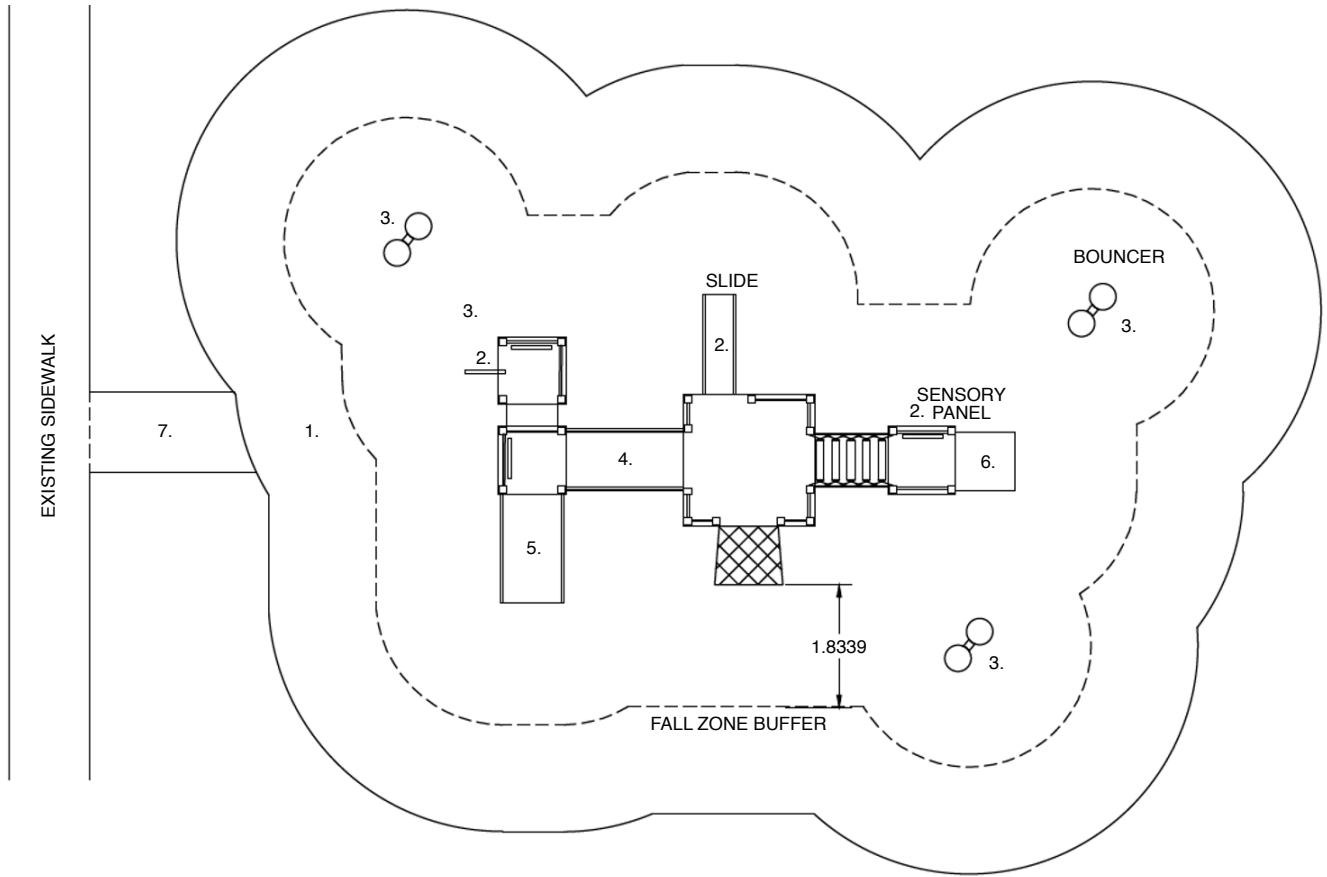
- tactile orientation map
- sensory play panels
- accessible seating



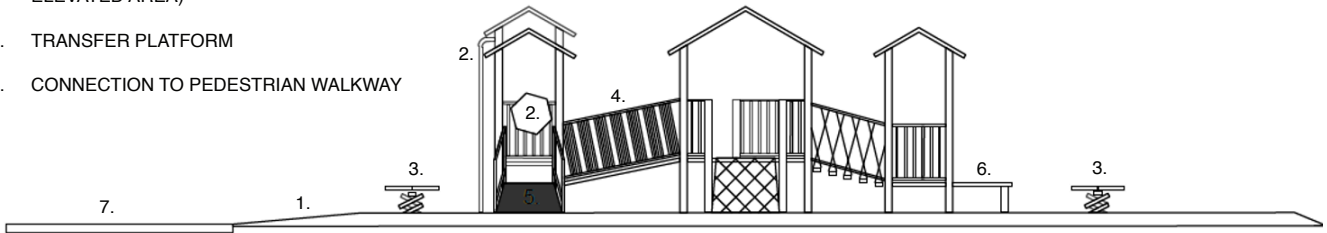
**Figure 24: Accessible playground – medium**



**Figure 25: Accessible playground – large**



1. ACCESSIBLE SAFETY SURFACE
2. ELEVATED PLAY COMPONENT
3. GROUND-LEVEL PLAY COMPONENT
4. ELEVATED ACCESSIBLE BRIDGE (CONNECTING TWO ELEVATED AREAS)
5. ELEVATED ACCESSIBLE BRIDGE (CONNECTING GROUND LEVEL WITH ELEVATED AREA)
6. TRANSFER PLATFORM
7. CONNECTION TO PEDESTRIAN WALKWAY





## Accessible parking

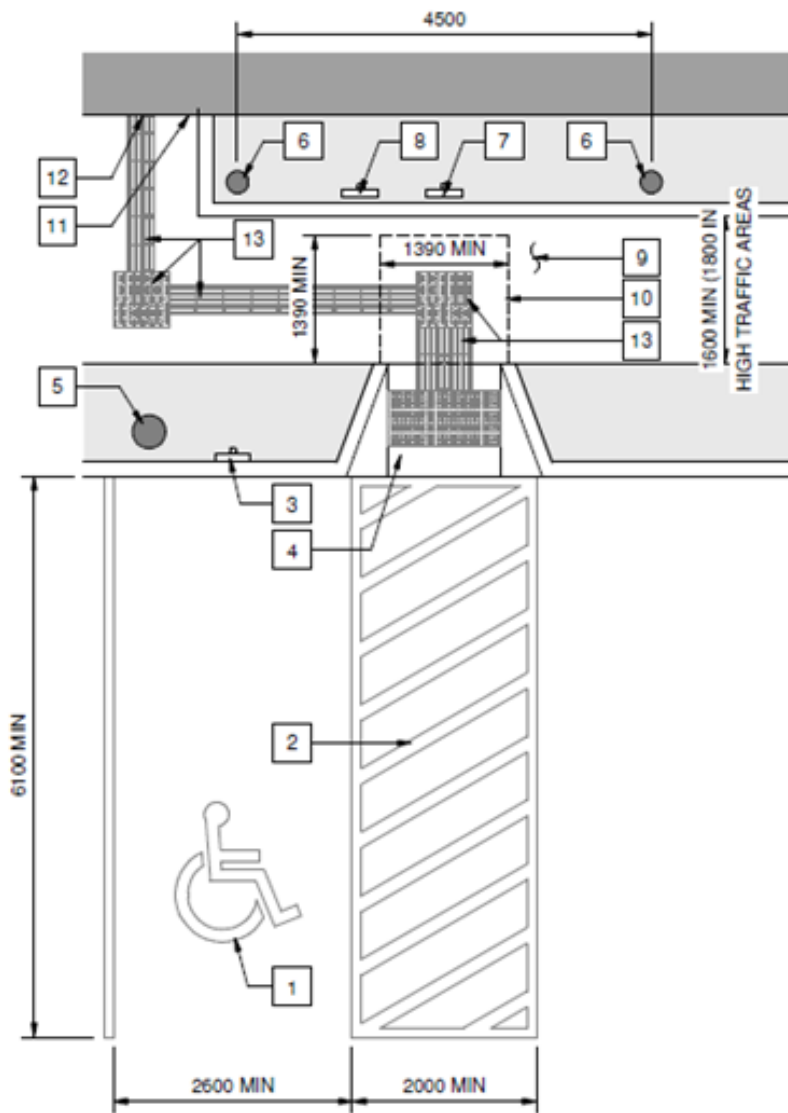
To determine the recommended number of accessible parking stalls in relation to your existing number of parking stalls, see table below. Note that flat rate costs will only calculate up to 6 accessible parking stalls. Costs for more than 6 accessible parking stalls are the responsibility of the applicant.

<b>Number of parking stalls</b>	<b>Number of accessible parking stalls</b>
2 to 50	1 to 3
51 to 100	2 to 4
101 to 200	4 to 8
201 to 300	5 to 10
301 to 500	6 to 12

Source: Table 10, CSA/ASC B651:23 Accessible design for the built environment. © 2023 Canadian Standards Association

Accessible parking spaces should be located as close as possible to the accessible building/destination entrance, but no more than 164' (50 m) away (best practice is no more than 98'5" (30 m) away).

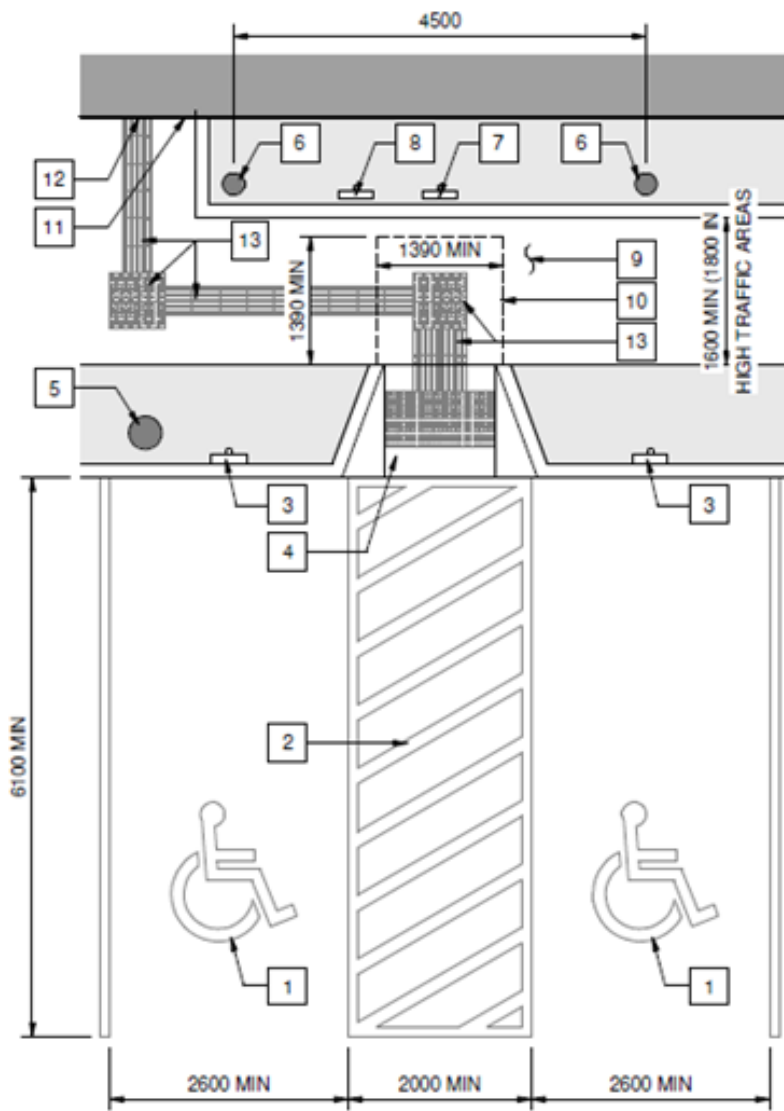
Figure 26: Accessible parking – single – below grade



**PLAN KEYNOTES:**

- 1 SYMBOL SURFACE MARKING
- 2 SHARED ACCESS AISLE WITH SURFACE MARKING
- 3 PARKING STALL IDENTIFICATION SIGNAGE (ONE PER STALL)
- 4 CURB CUT WITH TACTILE WARNING INDICATOR SURFACE (BELOW GRADE OF ACCESSIBLE PATH OF TRAVEL CONDITION; SEE DIAGRAM "ACCESSIBLE PARKING SECTIONS" FOR PARKING AT GRADE LEVEL CONDITION).
- 5 STALL AND AISLE LIGHTING: POLE MOUNTED LIGHT
- 6 PATH LIGHTING
- 7 ACCESS AISLE IDENTIFICATION SIGNAGE/ NO PARKING SIGNAGE (ONE PER ACCESS AISLE)
- 8 ACCESSIBLE ROUTE/ DIRECTION TO ACCESSIBLE ENTRY INFORMATIONAL WAYFINDING SIGNAGE.
- 9 ACCESSIBLE PATH FROM ACCESS AISLE TO ACCESSIBLE BUILDING/DESTINATION ENTRY.
- 10 MINIMUM TURNING SPACE, BUT NOT LESS THAN WIDTH OF RAMP
- 11 BUILDING FACE
- 12 BUILDING ACCESSIBLE ENTRY
- 13 TACTILE DIRECTION INDICATOR SURFACE (ONE PER ACCESS AISLE)

Figure 27: Accessible parking – multiple – below grade



**PLAN KEYNOTES:**

- 1 SYMBOL SURFACE MARKING
- 2 SHARED ACCESS AISLE WITH SURFACE MARKING
- 3 PARKING STALL IDENTIFICATION SIGNAGE (ONE PER STALL)
- 4 CURB CUT WITH TACTILE WARNING INDICATOR SURFACE (BELOW GRADE OF ACCESSIBLE PATH OF TRAVEL CONDITION; SEE DIAGRAM "ACCESSIBLE PARKING SECTIONS" FOR PARKING AT GRADE LEVEL CONDITION).
- 5 STALL AND AISLE LIGHTING: POLE MOUNTED LIGHT
- 6 PATH LIGHTING
- 7 ACCESS AISLE IDENTIFICATION SIGNAGE/ NO PARKING SIGNAGE (ONE PER ACCESS AISLE)
- 8 ACCESSIBLE ROUTE/ DIRECTION TO ACCESSIBLE ENTRY INFORMATIONAL WAYFINDING SIGNAGE.
- 9 ACCESSIBLE PATH FROM ACCESS AISLE TO ACCESSIBLE BUILDING/DESTINATION ENTRY.
- 10 MINIMUM TURNING SPACE, BUT NOT LESS THAN WIDTH OF RAMP
- 11 BUILDING FACE
- 12 BUILDING ACCESSIBLE ENTRY
- 13 TACTILE DIRECTION INDICATOR SURFACE (ONE PER ACCESS AISLE)



---

**Accessible parking stalls include:**

- surface markings in high contrast paint for accessible stall and access aisle
- 2 posts and 1 wheel stop per stall OR 1 curb cut per access aisle
  - depends on whether the parking stall is at grade (posts/wheel stop) or below grade (curb cut)
- 1 parking stall sign per stall
- 1 access aisle sign per access aisle
- 1 wayfinding sign per access aisle to direct people to accessible building/destination entrance
- architectural wayfinding leading people to accessible building/destination entrance
  - for example, colourful painted arrows, tactile bumps or lines on ground

---

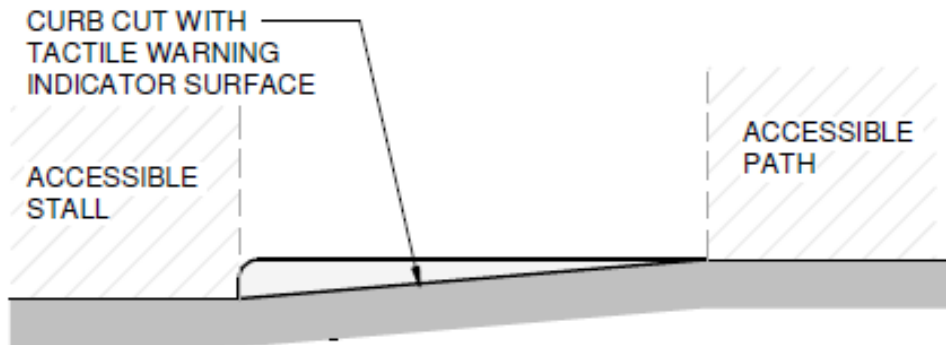
**Optional accessibility features:**

- surfacing in either concrete or asphalt
- lighting
- orientation cues/directional indicators at accessible building entrance
  - for example, high contrast colour or material on building façade
- accessible path connecting the access aisle to accessible building/destination entrance, with options for:
  - path lighting
  - path edge detection
  - additional curb cuts



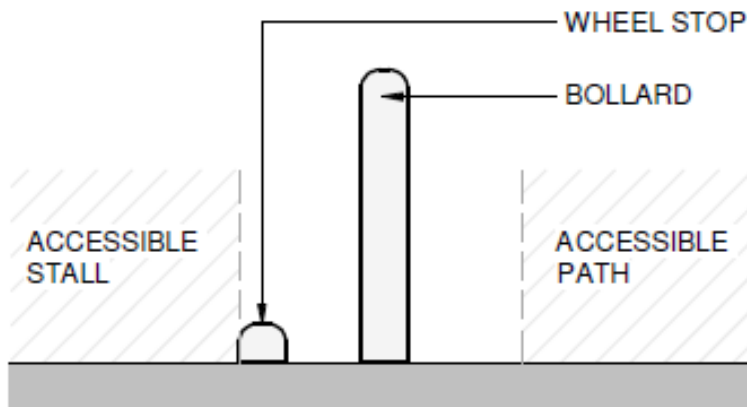


**Figure 28: Accessible parking – below grade vs at grade**



**NOTE:**  
ANY SLOPED WALKWAY STEEPER  
THAN 1:20 IS DESIGNED AS A RAMP

**A. ACCESSIBLE PARKING BELOW GRADE**



**B. ACCESSIBLE PARKING AT GRADE**

If your accessible parking stall is below grade, an additional curb cut with tactile bumps will be automatically included in flat rate costs. If your accessible parking stall is at grade, 1 wheel stop and 2 posts/bollards will be automatically included in flat rate costs.

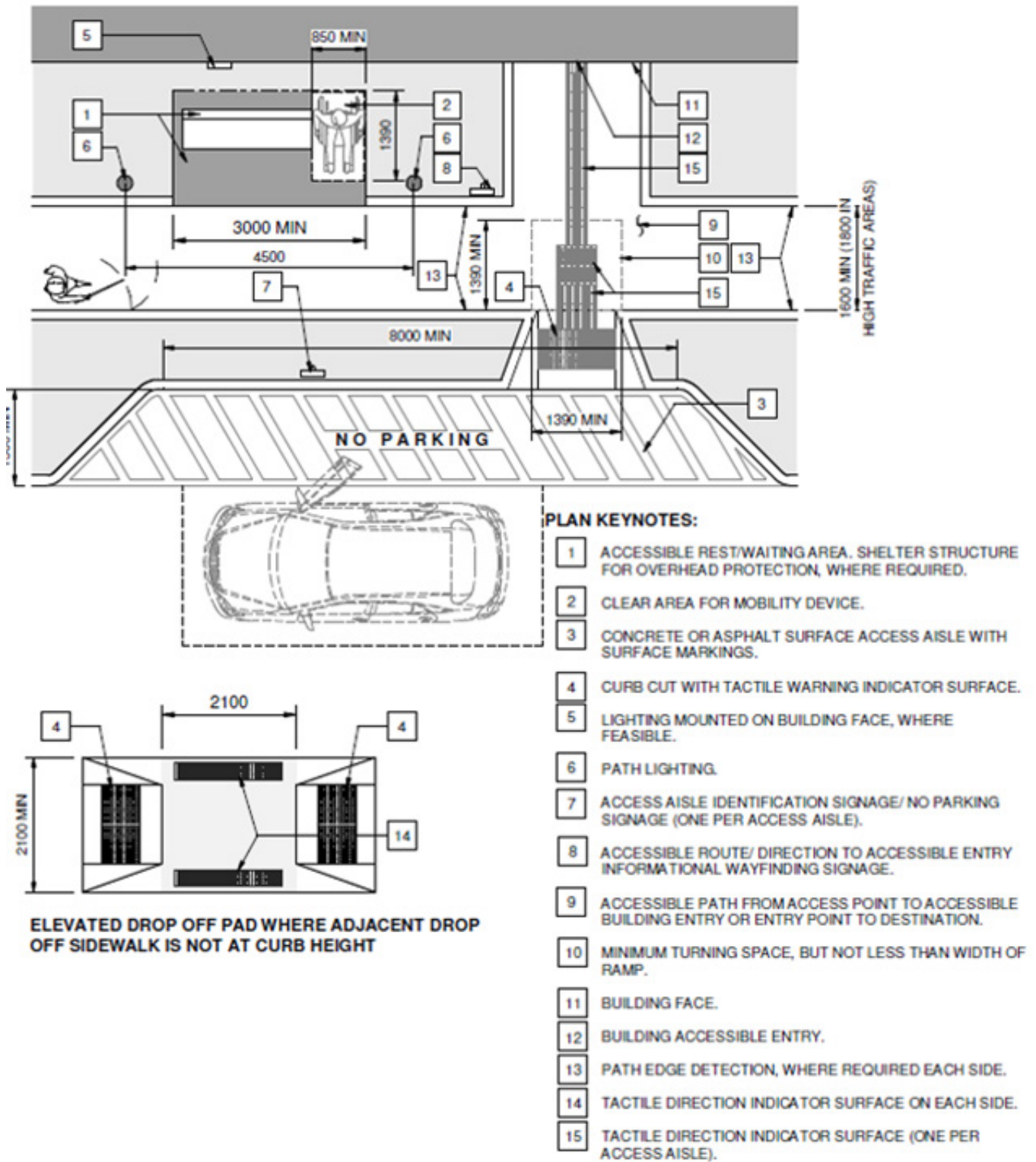


## **Accessible drop-off areas**

Accessible drop-off areas allow safer drop-off and pick-up of people who have difficulty walking long distances or have limited stamina, users of mobility aids, and people who travel with caregivers (for example, a person with vision loss).

Accessible drop-off areas should be located within 98'5" (30 m) of the accessible building/destination entrance, and away from traffic flow.

Figure 29: Accessible drop-off area





---

**Accessible drop-off areas include:**

- surfacing in concrete or asphalt (including removal of existing surfacing)
- surface markings in high contrast paint
- 2 posts and 1 wheel stop per stall OR 1 curb cut to join the drop-off area to a path
  - depends on whether the drop-off area is at grade (posts/wheel stop) or below grade (curb cut)
- 1 accessible drop-off area sign
- 1 wayfinding sign to direct people to accessible building/destination entrance
- architectural wayfinding leading people to accessible building/destination entrance
  - for example, colourful painted arrows, tactile bumps or lines on ground
- 1 rest/waiting area with accessible seating

---

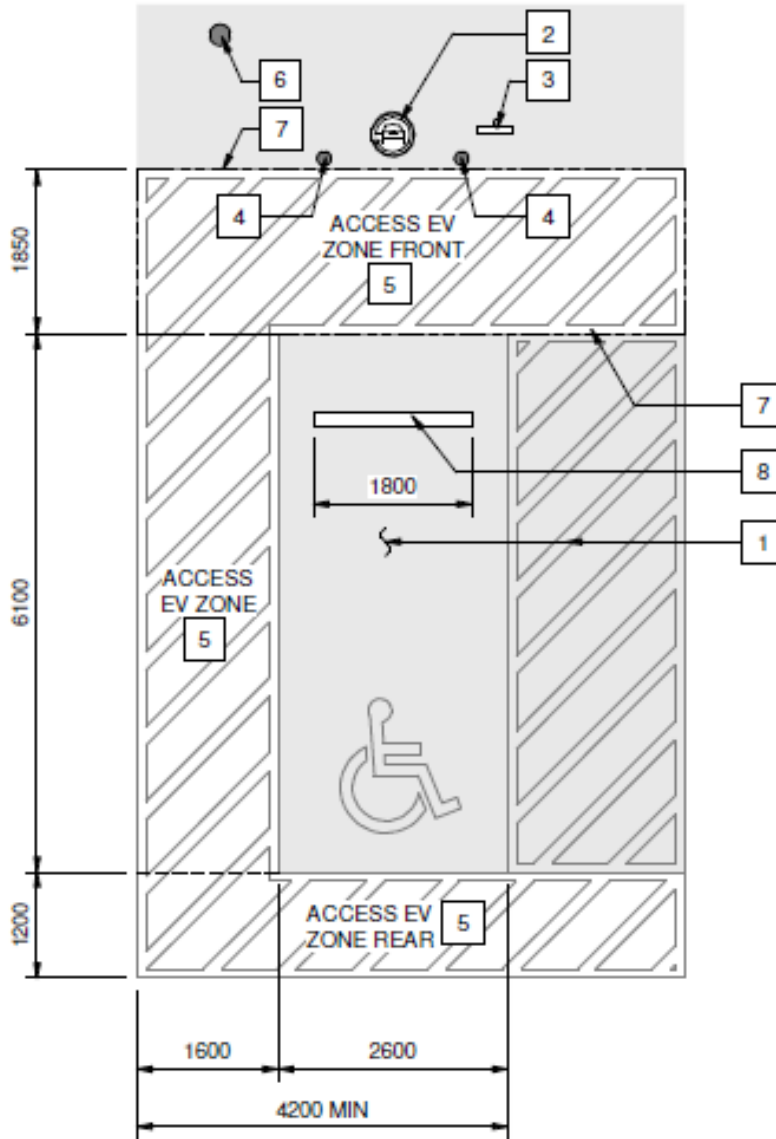
**Optional accessibility features:**

- lighting
- orientation cues/directional indicators at accessible building entrance
  - for example, high contrast colour or material on building façade
- accessible path connecting the accessible drop-off area to accessible building/destination entrance, with options for:
  - path lighting
  - path edge detection
  - additional curb cuts
- elevated drop-off pad
  - where curb height is not high enough to accommodate accessible transport (bus/van) lifts
  - at least 6" (150 mm) thick concrete or asphalt with concrete curb, and curb cuts on either end
- overhead protection in steel or wood for rest/waiting area
  - at least 5'11" by 9'10" (1800 mm by 3000 mm), with foundation

# Accessible electric vehicle charging stations

Accessible electric vehicle charging stations allow independent use by drivers with disabilities, including people who have limited hand dexterity, limb differences, or limb amputations that require use of adaptive driving controls.

**Figure 30: Accessible EV charging station – single – at grade**



**PLAN KEYNOTES:**

- 1 ACCESSIBLE PARKING STALL AND ACCESS AISLE (N.I.C.)
- 2 ACCESSIBLE FEATURES TO EV CHARGING EQUIPMENT. (BASE EQUIPMENT - N.I.C.)
- 3 ACCESSIBLE EV CHARGING STATION SIGNAGE (ONE PER CHARGER).
- 4 VEHICULAR IMPACT PROTECTION: BARRIER OR BOLLARDS. SEE GENERAL NOTE 1.
- 5 AREA OF MARKED ACCESS ZONES COMPLETE WITH SURFACE MARKINGS.
- 6 POLE MOUNTED LIGHT
- 7 LINE OF OVERHEAD PROTECTION (-----), IF REQUIRED
- 8 WHEEL STOP

Figure 31: Accessible EV charging station – multiple – at grade

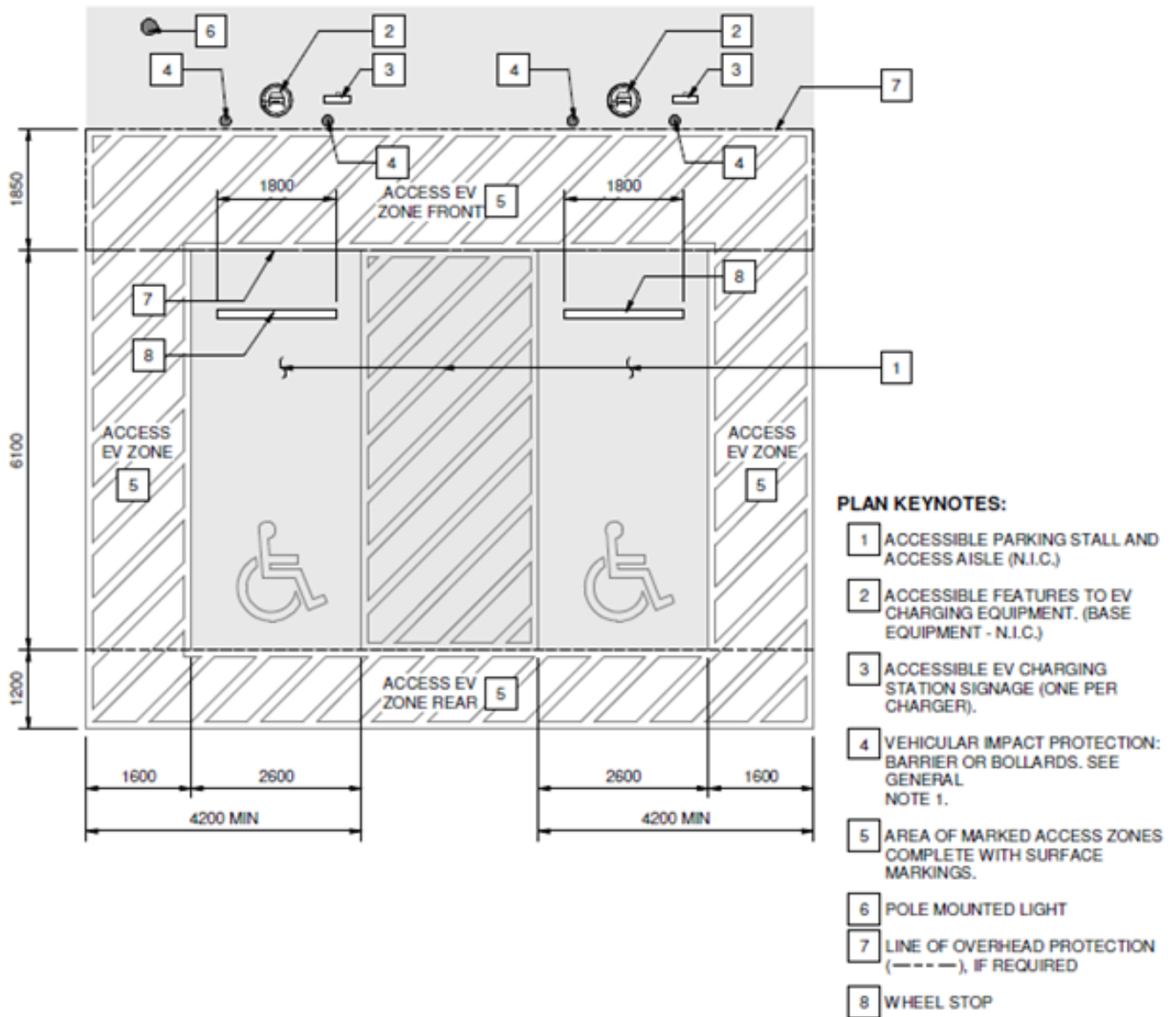


Figure 32: Accessible EV charging station – single – below grade

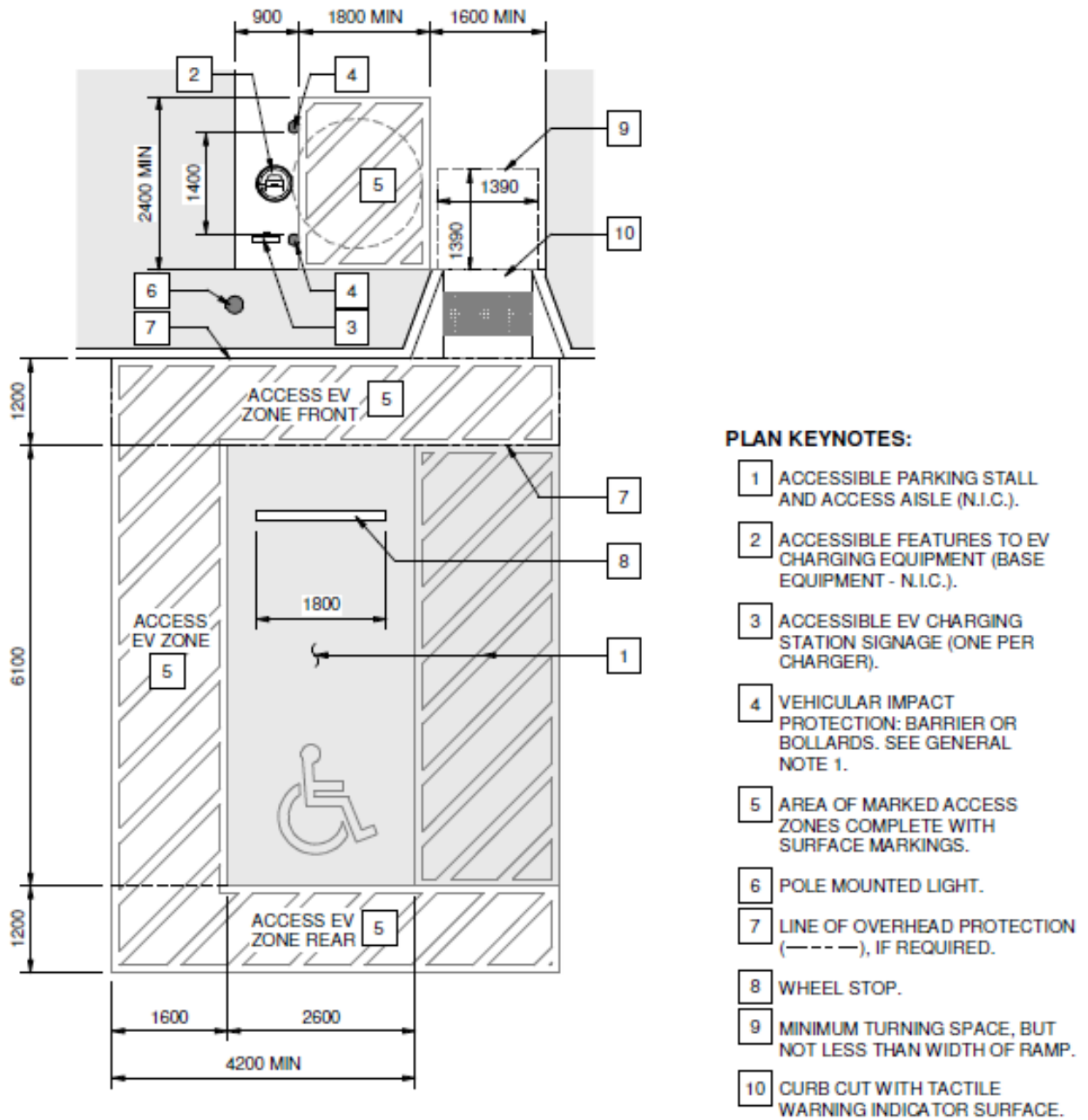
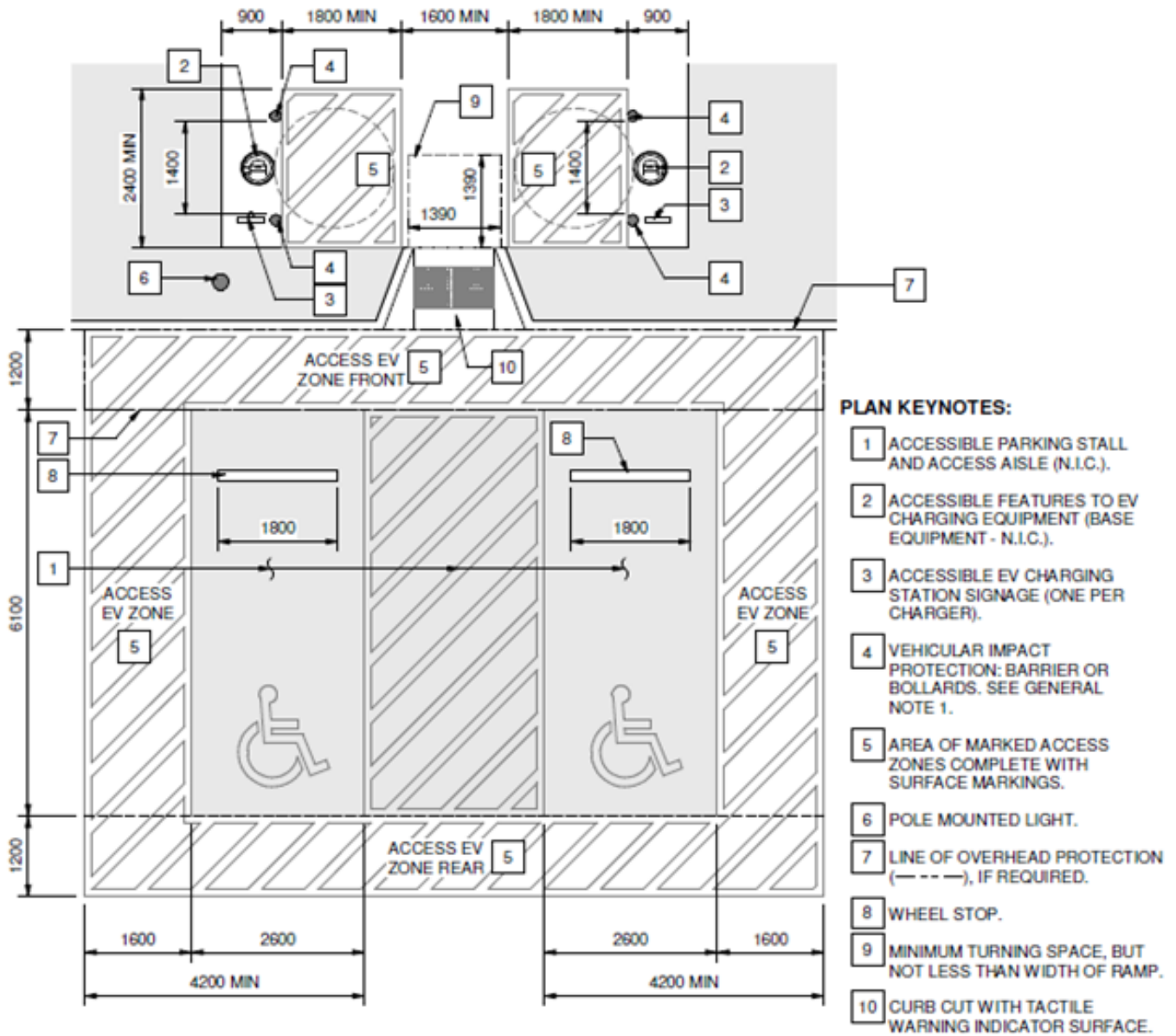




Figure 33: Accessible EV charging station – multiple – below grade





### Accessible electric vehicle charging stations include:

- surface markings in high contrast paint for the area surrounding the accessible EV charger
- accessibility features of EV charger (not the entire EV charger) (refer to the below section “How to choose an accessible EV charger” for these features)
- wheel stop and posts to protect the charger from other vehicles
  - 1 curb cut if the accessible EV charging station is below grade
- 1 accessible EV charging station sign per charger

### Optional accessibility features:

- surfacing for Access Zones in concrete or asphalt
- lighting
- overhead protection in steel or wood covering Front Access Zone only
  - includes maximum height clearance sign

### How to choose an accessible EV charger\*:

- Look for chargers with:
  - Charging cable cord reel:
    - a cord reel on the charging cable help reduce the weight of the cable should someone have difficulty carrying it to their vehicle
  - Reduced force needed to release the handle from the charger:
    - ensure the releasing mechanism of the plug requires no more than 5lbs of pressure
- Avoid chargers with:
  - Perfectly round handles:
    - can be difficult to grasp for someone with mobility issues
  - Bright flashing lights:
    - can disorient people (especially at night)

### Additional things to consider\*\*:

- Look for chargers with:
  - speech output
  - volume control
  - braille instructions
  - wireless or inductive chargers as they become available (currently there are no manufacturers that produce accessible wireless or inductive chargers)

\*Note that the above features of an accessible EV charger are covered by flat rate costs.

\*\*Note that the above things to consider are not covered by flat rate costs.